

# OPERATING INSTRUCTIONS

## STEREO TUNER

### SANSUI TU-7700



**Sansui**

SANSUI ELECTRIC CO., LTD.

We are grateful for your choice of the Sansui TU-7700 AM/FM stereo tuner. Before you begin to operate it, may we suggest that you read this booklet of operating instructions as well as the instructions sheet once carefully? You will then be able to connect and operate it correctly, and enjoy its superb performance for years.

## ●FUNCTIONAL FEATURES

\* Smooth tuning feel.

The SIGNAL and TUNING meters permit instant and accurate station pinpointing. The FM STEREO indicator lights up to let you know when the broadcast you're receiving is in stereo.

\* Adjustable output level.

The set is equipped with an OUTPUT LEVEL control on the front panel, you can match the output level of the tuner with that of any other program source (such as a deck or a turntable), connected to your amplifier. Therefore, you do not need to take trouble and adjust the volume control when switching from the tuner to a tape deck or turntable, or vice versa.

\* Extra conveniences for clear FM reception.

The set is provided with easily-accessible front-panel switches for steady and clear FM reception. The FM MUTING and MPX NOISE CANCELLER switches come in handy for those living in areas where signal strength is too weak, i.e. the locations where the desired station may be very far or where tall buildings may be dominating the area. The FM ATTENUATOR switch is for those who live in areas where signal strength is too strong.

\* Device for reduced multipath reception.

Switching the METER SELECTOR switch to MULTIPATH lets the SIGNAL meter function as multipath detection meter. You can thus easily orient an FM antenna in a direction where the multipath reflection is minimum and therefore you hear the optimum FM reception with least distortion. More critical multipath check is possible when an oscilloscope is connected to the FM MULTIPATH OUTPUT terminals on the set's rear panel.

\* Terminals provided for two different types of FM antennas.

Provisions are made for both 75-ohm and 300-ohm FM antenna terminals. Connection is extremely simple when setting up an outdoor antenna using either a 75-ohm unbalanced coaxial type lead-in cable or a 300-ohm balanced feeder type lead-in cable.

## Table of Contents

IMPORTANT PRECAUTIONS	2
REAR-PANEL CONNECTIONS	3
HINTS FOR BETTER RECEPTION	4
OPERATING PROCEDURES	5, 6
CONDITIONS MISTAKEN FOR BREAKDOWNS	7
INSTALLING OUTDOOR FM ANTENNA CORRECTLY	8, 9
SIMPLE MAINTENANCE HINTS	10
SIMPLE MAINTENANCE HINTS/SPECIFICATIONS	11
SCHEMATIC DIAGRAM	12



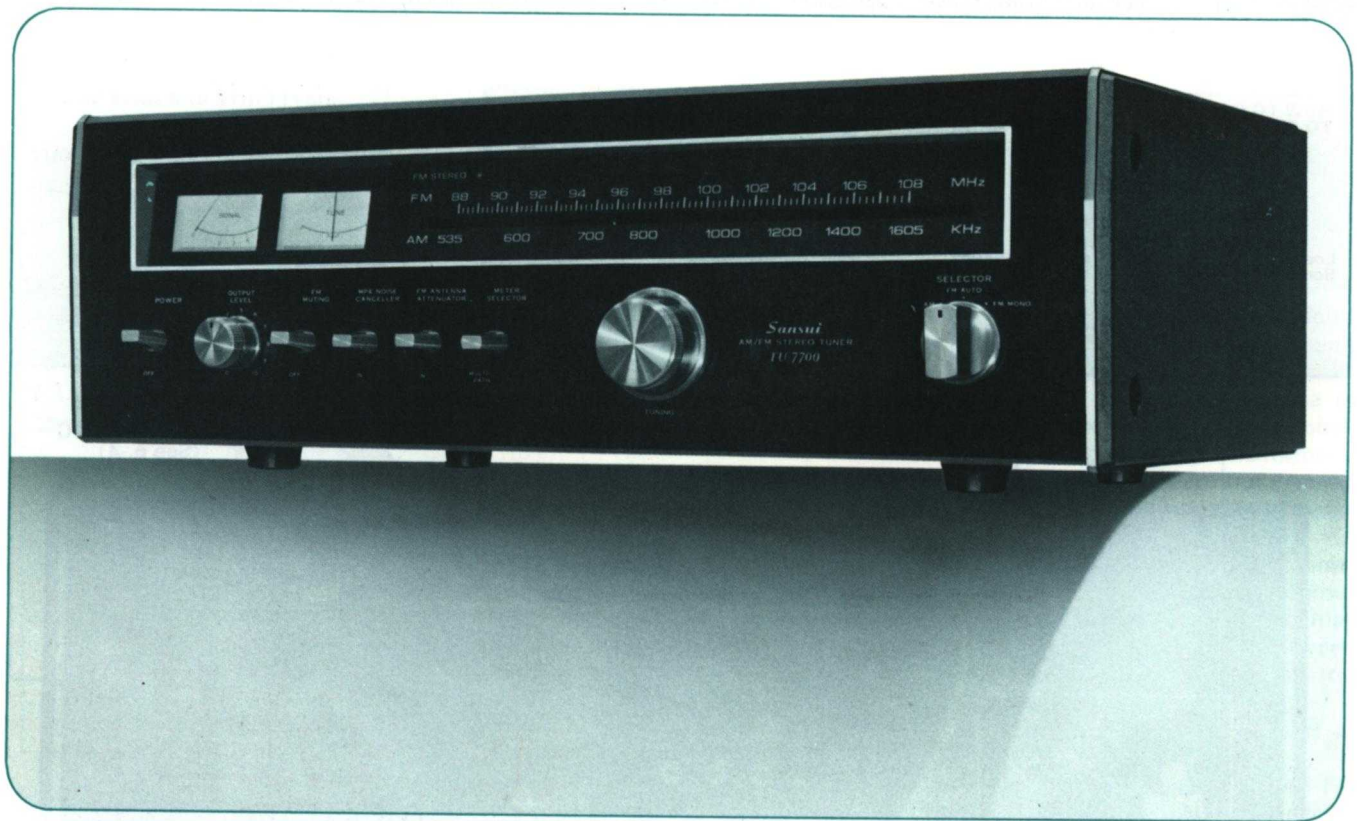

## IMPORTANT PRECAUTIONS

To keep the set in top condition all the time, observe these precautions:

1. Install the set where there is a good circulation of air.
2. Avoid an extremely hot or dusty place.
3. If the set is placed on a shelf, be sure that the shelf board is thick and strong.

### HEAT RADIATED BY THE SET

As transistors are sensitive to heat, the enclosure of this set is designed to provide a good dissipation of the heat radiated inside this set. Thus, if you place something on top the enclosure, place the set inside a closed box and operate it for many hours, it is possible that the set will break down. Always try to provide sufficient circulation of air around the set. But removing the enclosure or the bottom plate to allow better ventilation is not only dangerous but undesirable from the standpoint of electrical performance.

### AC OUTLET

An AC outlet marked 'UNSWITCHED' is provided on the rear panel. The voltage delivered at this AC outlet is the same as the power supply voltage used. It is convenient to use it to power a program source such as your turntable or tape deck. It has a 150-watt capacity. Do not connect any equipment whose power consumption exceeds the capacity of the outlet, as it is extremely dangerous.





# REAR-PANEL CONNECTIONS

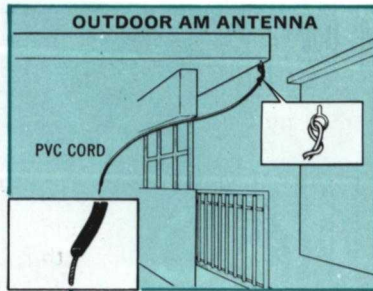
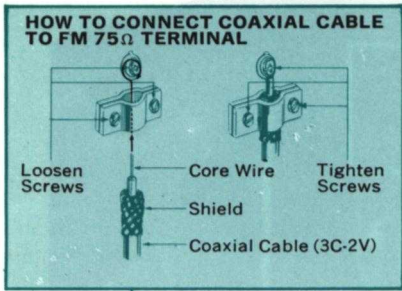

**GROUNDING**  
(See p. 4)

TO TAPEDECK, ETC.  
**CAUTION:**  
 Never connect equipment with greater power requirements than specified maximum rating.

DISCRIMINATOR OUTPUT TERMINAL  
(See p. 10)



**INTEGRATED AMPLIFIER**

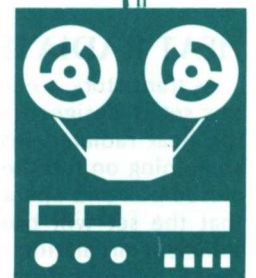
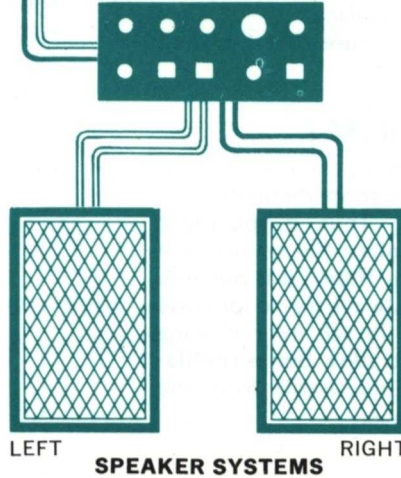

— LEFT CHANNEL  
 — RIGHT CHANNEL

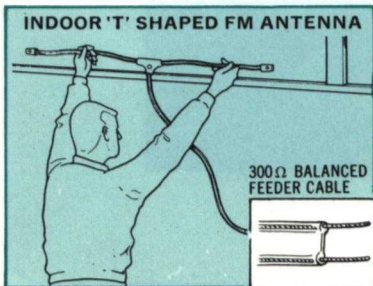
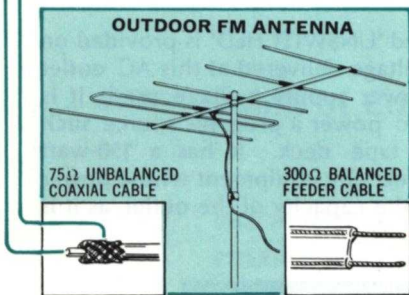



# HINTS FOR BETTER RECEPTION

It is always recommended to install outdoor antennas so that you may receive noise-free FM and AM broadcasts with optimum tonal quality. You will find an outdoor antenna—especially one for FM—particularly effective if you are remote from broadcasting transmitters or surrounded by high mountains, buildings or other obstacles.

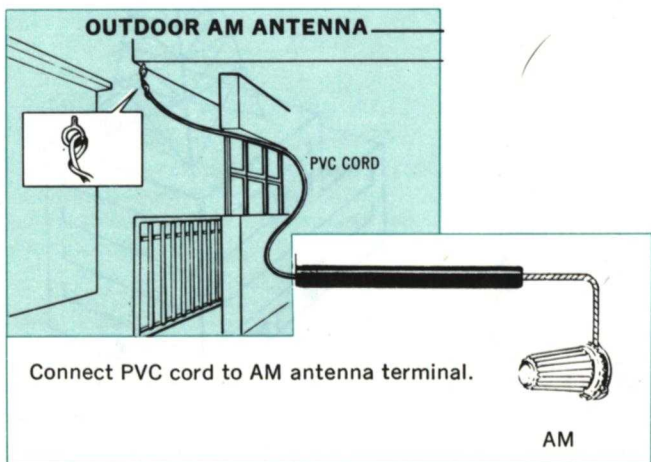
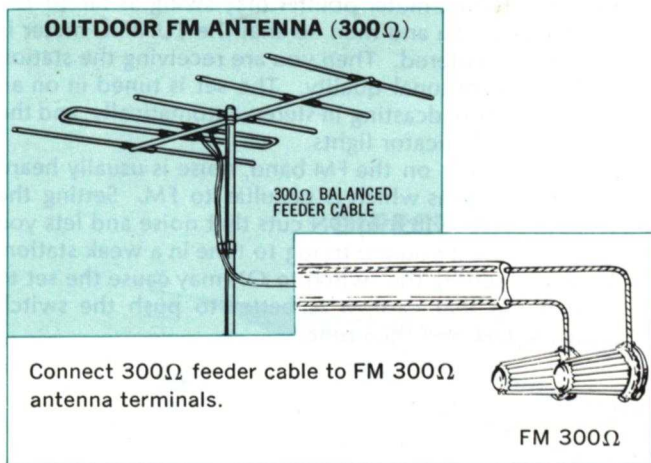
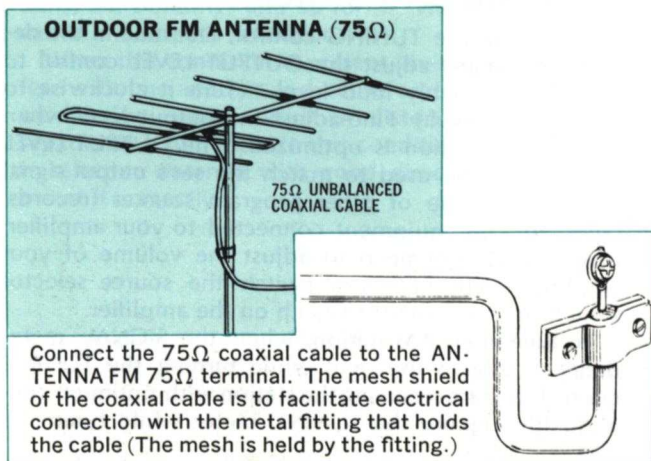

## FM ANTENNAS

Outdoor FM antennas are commercially available with three, five or seven 'elements'. The more elements an antenna has, the greater distance it is generally intended to cover. You may connect an antenna to your set either by means of coaxial cable (75-ohm unbalanced) or feeder cable (300-ohm balanced). The former is more expensive but more effectively keeps out external noise—especially the ignition noise of nearby automobiles—and transmit the signals more efficiently.

It is advised that you decide on the type of antenna and cable to use after consultation with your Sansui dealer. Depending on the type of antenna, you may require an impedance matching transformer between the antenna and the connecting cable, and this too should be found out from the dealer.

**How to connect:** Connect the antenna to your set as illustrated in the diagram.

If you are using coaxial cable, connect it to the FM 75Ω terminals; if you are using feeder cable, connect it to the FM 300Ω terminals.

### ⟨Note for Installing⟩

- ◆ To avoid ignition noise produced by automobiles and motor-cycles, install the antenna as far away from the street as possible.
- ◆ As an antenna is directional, adjust its height and direction while actually receiving your favorite FM station.
- ◆ Be careful so that the antenna or the lead-in cable does not touch the electrical power line around your house.
- ◆ It is always advisable to keep the lead-in cable as short as possible.

## AM ANTENNA

When you cannot obtain the desired results by using the AM ferrite bar antenna only, connect a PVC cord to the AM antenna terminal, extending it outdoors if possible.

## GROUNDING

If you connect a grounding lead to the grounding terminal marked GND on the rear panel, the noise contained in radio broadcasts may decrease. It may also keep external noises from creeping into the set.

The grounding lead may either be standard PVC cord or enameled wire. Attach a small copper plate or carbon rod to its end, and bury it deep underground. Or if there is a special grounding wire or terminal in your room, or if your water piping is of iron, the grounding lead may be connected to them. NEVER connect it to your gas piping.



## 1. POWER

### ① POWER Switch

Raise the lever switch to ON to turn the set on, push it down to OFF to turn it off.

## 2. OPERATION OF THE AMPLIFIER

Operate your amplifier to which this set is connected so that you will hear radio broadcasts.

## 3. BAND SELECTION

### ② SELECTOR Switch

This switch selects the band (AM or FM) that you want to hear.

**AM:** To receive AM broadcasts.

**FM AUTO:** To receive FM broadcasts, whether stereo or mono.

**FM MONO:** If the FM stereo reception is too noisy for pleasant listening, set the switch to this position. The broadcast will be received in mono but the noise will be substantially decreased.

## 4. STATION SELECTION and OUTPUT LEVEL ADJUSTMENT

### ③ TUNING Control

### ④ OUTPUT LEVEL Control

### ⑤ FM MUTING Switch

By turning the TUNING control, first tune in the desired station and adjust the OUTPUT LEVEL control to attain a reasonably loud level. (Turn it clockwise to increase the level.) Fine-adjust the output level when the radio reception is optimized. The OUTPUT LEVEL control is to be used to match the set's output signal level with those of other program sources (records, tapes, etc.) on equipment connected to your amplifier; then you do not need to adjust the volume of your amplifier each time you switch the source selector switch or tape monitor switch on the amplifier.

**To tune in an AM station,** when the SIGNAL meter deflects fully to the right while turning the TUNING control, you are receiving the station with optimum tonal quality. Ignore the TUNING meter while tuning on AM.

**To tune in an FM station,** turn the TUNING control so that the SIGNAL meter pointer may swing as far to the right as possible and then so that the TUNING meter is accurately centered. Then you are receiving the station with optimum tonal quality. The set is tuned in on an FM station broadcasting in stereo automatically, and the FM STEREO indicator lights.

When tuning on the FM band, noise is usually heard between stations which is peculiar to FM. Setting the FM MUTING switch to ON cuts that noise and lets you tune quietly. If you are trying to tune in a weak station, however, setting the switch to ON may cause the set to miss it. In that case, it is better to push the switch down to OFF and then tune.



## SIGNAL & TUNING METERS

Tune in the desired station while observing these meters. To use the SIGNAL meter to check the signal strength, the METER SELECTOR switch must be at the SIGNAL position. To use it to check the multipath reflection, the switch must be at the MULTIPATH position.

## FM STEREO INDICATOR

Lights when the set is tuned in on an FM station broadcasting in stereo.



● The numbers indicated in the photograph above coincide with the colored switch designations.

## 5. CLEAR FM RECEPTION

### ⑥ FM ANTENNA ATTENUATOR Switch

This switch selects the input sensitivity for FM stations. It should normally be at the OUT position. If while receiving an FM station, located in your vicinity, you hear too coarse or distorted reception due to excessively strong signal strength, however, flip the switch down to IN.

### ⑦ MPX NOISE CANCELLER Switch

When you hear disturbing noise while receiving FM stereo broadcasts, push the switch down to IN; high-frequency noise will then be suppressed and the broadcasts will sound more pleasant. At all other times, however, the switch should be at its OUT position.

If you should still hear noise even when the MPX NOISE CANCELLER switch is IN, turn the SELECTOR switch to FM MONO; you should hear less noise, though in monaural.

● Excessive noise is often caused when the incoming signal is too weak. Re-orientation or re-location of the antenna may result in improving the reception of such a weak signal.

### ⑧ METER SELECTOR Switch

To use the SIGNAL meter to check the signal strength, this switch should be at the SIGNAL position. To use it to check the multipath reflection, this switch must be pushed down to MULTIPATH; you can orient the antenna for the best FM reception.

The radio wave, used for FM broadcast, possesses a natural tendency to travel straight ahead and be reflected by various obstacles just as a light beam does. As a result, an antenna receives both the radio wave arriving directly from the broadcasting station and the waves reflected by nearby mountains, tall buildings and so forth. (Multipath reflection. Refer to the page 8 for details.) When this condition is present, the radio waves interfering with one another resulting in amplitude and phase modulations, and distortion and reduced separation. To minimize this condition, it is necessary to orient the antenna correctly.

You are receiving optimum FM reception with the least multipath phenomenon when the SIGNAL meter deflects fully to the left. Therefore, tune in an FM station and then turn the antenna until the SIGNAL meter pointer swings as far to the left as possible before fixing it.

● You can orient the antenna more critically if you have an oscilloscope. Refer to page 9.

# CONDITIONS MISTAKEN FOR BREAKDOWNS

Many of the troubles which seem to be a fault in the set may be caused by wrong operation or by external devices. These can be easily corrected by simple checking and easy remedies. If you notice a condition which looks like a breakdown of the set, examine the various connections and your operating procedure

once, then look up the condition in the following chart to see if it cannot be easily removed. If this fails to improve the situation and the set definitely seems faulty, please contact the Sansui dealer from whom you purchased the set or your nearest Authorized Sansui Service Station.

PROGRAM	SYMPTOM	PROBABLE CAUSE	WHAT TO DO
AM, FM or MPX reception	* Constant or intermittent noise heard at times or in certain areas.	<ul style="list-style-type: none"> <li>* Discharge or oscillation caused by electrical appliances, such as fluorescent lamp, TV set, D.C. motor, rectifier or oscillator.</li> <li>* Natural atmospheric phenomena</li> <li>* Insufficient antenna input due to ferroconcrete structure or long distance from station.</li> </ul>	<ul style="list-style-type: none"> <li>* Attach noise limiter to electrical appliance producing noise, or attach it to set's power source.</li> <li>* Install outdoor antenna and ground set to improved S/N ratio.</li> <li>* Reverse power cord plug/receptacle connections.</li> <li>* If noise occurs at certain frequency, attach wave trap to input.</li> <li>* Keep set at proper distance from other electrical appliances.</li> </ul>
FM reception	<ul style="list-style-type: none"> <li>* Noisy</li> </ul> <p>Note: FM reception is affected considerably by transmitting conditions of station, such as power and antenna efficiency. As a result, you may receive one station quite well while receiving another station poorly.</p>	<ul style="list-style-type: none"> <li>* Poor noise limiter effect or too low S/N ratio due to insufficient antenna input.</li> </ul>	<ul style="list-style-type: none"> <li>* Install antenna for maximum signal strength.</li> <li>* If this does not prove effective, use exclusive FM outdoor antenna.</li> <li>* Excessively long lead-in wire of antenna may cause noise.</li> </ul>
	* A series of pops	* Ignition noise caused by starting of nearby automobile engine.	* Install antenna and its lead-in wire at proper distance from street or increase antenna input.
	* Tuning noise between station.	<ul style="list-style-type: none"> <li>* Results from nature of FM reception.</li> <li>* FM MUTING switch at OFF.</li> </ul>	* Turn on FM MUTING switch.
FM-MPX reception	* Noise heard during FM-MPX reception but inaudible during FM mono reception.	* Weaker signal because service area of FM-MPX broadcast is only half that of FM mono broadcast.	<ul style="list-style-type: none"> <li>* Orient antenna for maximum antenna input.</li> <li>* Set MPX NOISE CANCELLER switch to IN position.</li> </ul>
AM reception	* Noise heard at particular time of day, in certain area or over part of dial.	* Peculiar to AM broadcasts.	<ul style="list-style-type: none"> <li>* Install antenna for maximum antenna efficiency. See 'AM Antenna'.</li> <li>* In some cases, noise can be eliminated by grounding tuner or reversing power cord plug/receptacle connections.</li> </ul>
	* High-frequency noise.	<ul style="list-style-type: none"> <li>* Beat interference by adjacent station.</li> <li>* TV set too close to stereo systems.</li> </ul>	<ul style="list-style-type: none"> <li>* Turn on amplifier's High Filter.</li> <li>* Keep TV set at proper distance from stereo system.</li> </ul>



# INSTALLING OUTDOOR FM ANTENNA CORRECTLY

## WHAT IS MULTIPATH REFLECTION?

As the radio wave used for FM broadcast is of high frequencies, it possesses a natural tendency to advance in a straight line and be reflected by various obstacles just as a light beam does. As result, an antenna receives both the radio wave arriving directly from the broadcasting station and the waves reflected by nearby mountains, tall buildings and so forth. This phenomenon is called a multipath reflection.

When this condition is present, the radio waves interfere with one another and cause amplitude and phase modulation, which result in distortion and reduced separation. To minimize this condition, it is necessary to select an antenna with good directionality and also orient it correctly.

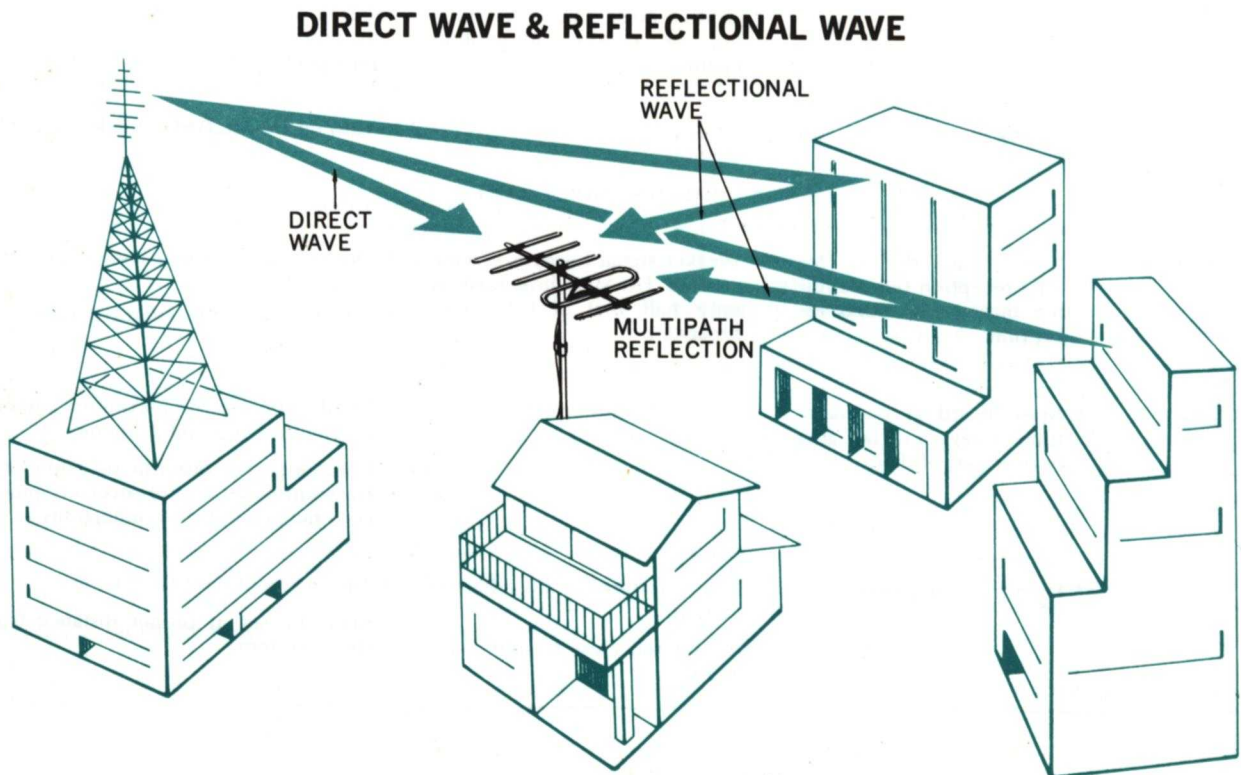

## HOW TO USE FM MULTIPATH OUTPUT TERMINALS

The multipath condition can be visually observed by connecting an oscilloscope to the FM MULTIPATH OUTPUT terminals on the rear panel of the set, so that you may install the antenna in the correct direction.

The two terminals (indicated as V and H) deliver the output signals described below:

**V:** Delivers the detector output of signals amplitude-modulated by the multipath reflection, if any. If no multipath reflection exists, no output will be provided.

**H:** Delivers the set's discriminator output signal, whose level changes with the level of the original audio signal.

## HOW TO CONNECT AND OPERATE AN OSCILLOSCOPE

1. Connect the oscilloscope to the FM MULTIPATH OUTPUT terminals as indicated in the diagram below—namely, its vertical axis to the V terminal and its horizontal axis to the H terminal.
2. Tune in your favorite FM station accurately while watching the SIGNAL and TUNING meters, and actually receive it.
3. Observe the waveform on the oscilloscope. Set the horizontal axis sensitivity of the oscilloscope to 10mV/cm while raising its vertical axis sensitivity to an optimum level.
4. Adjust the position and direction of the antenna and fix it where the height of the waveform is minimized. See a sample oscilloscope waveform as below.

### SAMPLE OSCILLOSCOPE WAVEFORMS OF MULTIPATH REFLECTION

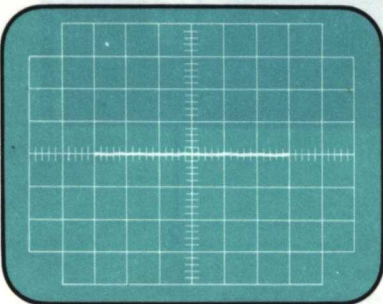

When no multipath reflection exists

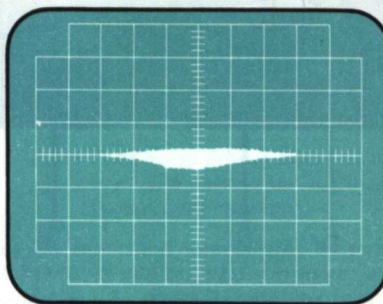

When a slight multipath reflection exists

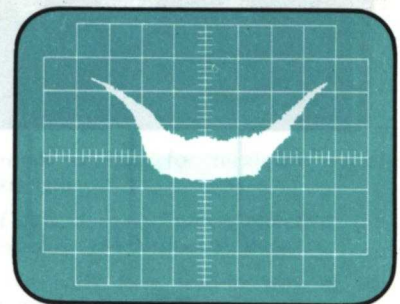

When a serious multipath reflection exists

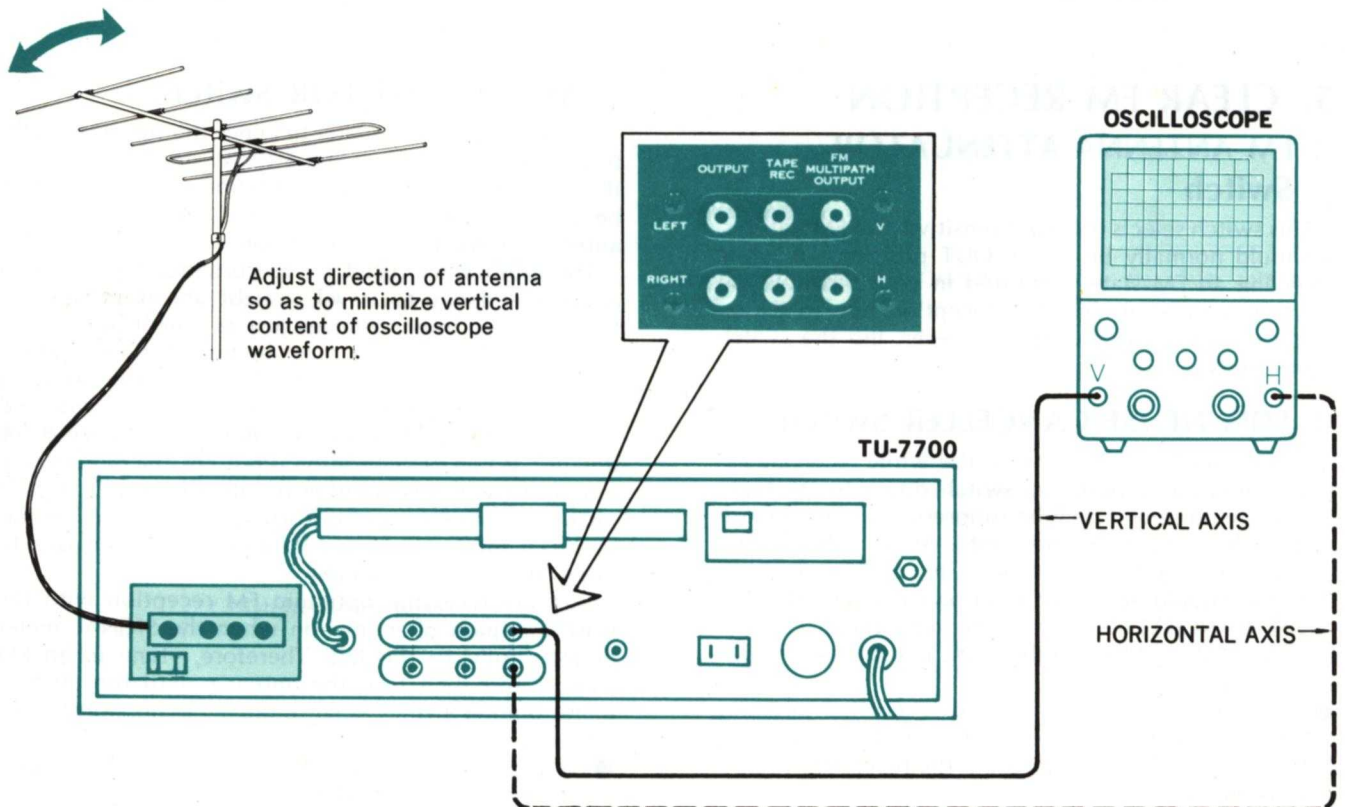



# SIMPLE MAINTENANCE HINTS

## RECORDING INTO A TAPE DECK

Radio broadcasts can be recorded by connecting a tape deck to the set. Connect the TAPE REC terminals on the rear panel with the recording inputs of a tape deck (often indicated LINE INPUT), utilizing shielded cables with pin plugs.

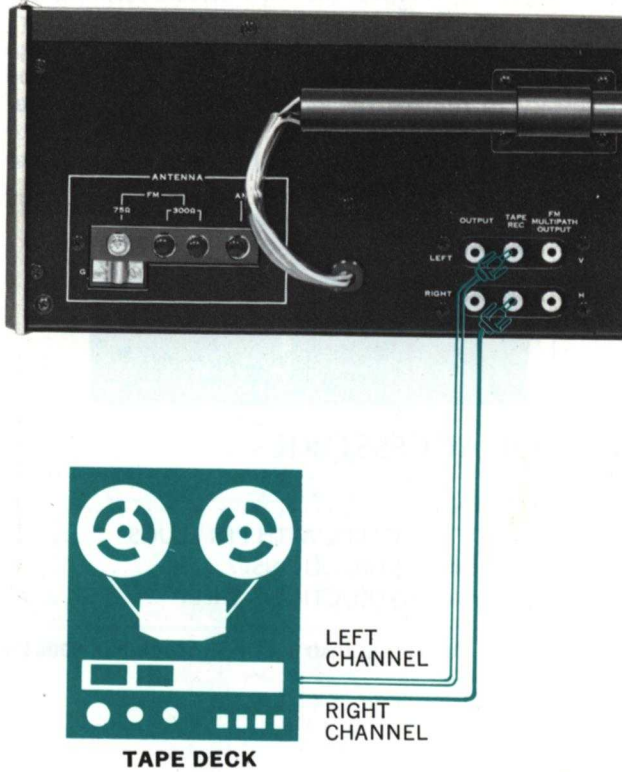

## DISCRIMINATOR OUTPUT TERMINAL

Four-channel stereo is fast becoming popular as a means of reproduction of the live sound field. Four-channel FM broadcasts are already underway in many areas of the world using Sansui QS and other matrix 4-channel systems. The discrete 4-channel system is also expected to be introduced to FM in the not to distant future. To receive discrete 4-channel FM broadcasts, you will need an adaptor in addition to the set itself. The DISCRIMINATOR OUTPUT terminal on the set's rear panel is for connecting such adaptor.

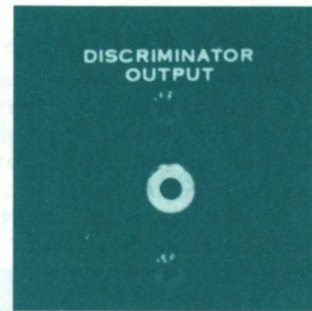

# SIMPLE MAINTENANCE HINTS

## SHOULD THE POWER FUSE BLOW

If no Dial Indicator should glow and the set simply remains dead even after you have turned on its POWER switch, it is possible that its power fuse has blown.

If this happens, disconnect the power cord from the AC outlet at once and examine the power fuse on the rear panel. If you find it blown, replace it with a new glass-tubed fuse of the rated capacity (1-ampere for 100 to 117 volts, 0.5-ampere for 220 to 240 volts).

Never use a fuse of a different capacity or a piece of wire, even as a stop-gap measure, or serious danger could result.

## ABOUT THE FM DE-EMPHASIS SWITCH

Use this switch inside the set only if you move to an area where the FM de-emphasis characteristic is different. It is adjusted to the correct de-emphasis characteristic of your area in our factory prior to shipment, so there is normally no need to touch it. The correct de-emphasis is 50  $\mu$ sec for Japan and Europe, and 75  $\mu$ sec for the U.S.A. and Southeast Asia.

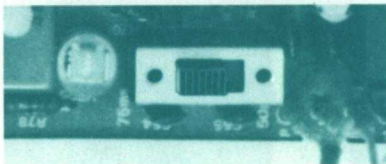

## ABOUT THE VOLTAGE ADJUSTMENT

Your set is adjusted to operate at the correct power supply voltage of your area prior to shipment from our factory. If you move after purchasing it, or send it as a gift to a friend living in an area where the voltage is different, it may be necessary to adjust its Voltage Selector.

To adjust it, remove the two screws securing the name plate on the rear panel, then set the arrow mark on the Voltage Selector Plug to the correct Voltage indication (100, 117, 220 or 240 volts). It may be necessary to replace the power fuse as well whenever the voltage has changed. For operation at 100 to 117 volts, use a 1-ampere fuse. For operation at 220 to 240 volts use a 0.5-ampere one.



## LIST OF ACCESSORIES

- |  |   |
|--|---|
| 1. FM-ANTENNA .....                      | 1 |
| 2. CONNECTION CABLE WITH PIN PLUGS ..... | 2 |
| 3. OPERATING INSTRUCTIONS.....           | 1 |
| 4. OPERATING INSTRUCTIONS SHEET .....    | 1 |

Operating Instructions **Stock No. 9208350**

# SPECIFICATIONS

### FM SECTION

TUNING RANGE .....	88 to 108MHz
SENSITIVITY (IHF) .....	1.8 $\mu$ V
QUIETING SLOPE.....	40dB 1.8 $\mu$ V, 50dB 3 $\mu$ V, 60dB 10 $\mu$ V, 70dB 50 $\mu$ V
TOTAL HARMONIC DISTORTION	
MONO .....	less than 0.2%
STEREO .....	less than 0.3%
SIGNAL TO NOISE RATIO..	better than 75dB
SELECTIVITY .....	better than 80dB
CAPTURE RATIO (IHF) ....	less than 1.5dB
IMAGE FREQUENCY REJECTION	
.....	better than 75dB
IF REJECTION .....	better than 90dB
SPURIOUS RESPONSE REJECTION	
.....	better than 80dB
STEREO SEPARATION.....	better than 40dB at 1KHz better than 30dB at 10KHz
SPURIOUS RADIATION....	less than 34dB
FREQUENCY RESPONSE....	20 to 15,000Hz
FM ANTENNA INPUT IMPEDANCE	
.....	300 $\Omega$ balanced, 75 $\Omega$ unbalanced
FM ANTENNA ATTENUATOR	
.....	-20dB

### AM SECTION

TUNING RANGE .....	535 to 1,605KHz
SENSITIVITY (Bar Antenna)	50dB/m
SELECTIVITY .....	better than 30dB
IMAGE FREQUENCY REJECTION	
.....	better than 80dB/m at 1MHz
IF REJECTION .....	better than 80dB/m at 1MHz

### OTHERS

OUTPUT .....	0 to 0.775W
REC OUTPUT .....	0.4V
POWER REQUIREMENTS	
POWER VOLTAGE .....	100, 117, 220, 240V 50/60Hz
POWER CONSUMPTION ..	.9W (rated)
DIMENSIONS .....	
.....	434mm, (17 $\frac{1}{8}$ " W
.....	130mm (5 $\frac{1}{8}$ " H
.....	243mm (9 $\frac{9}{16}$ " D
WEIGHT.....	
.....	6.9Kg (15.2 lbs) net
.....	8.3Kg (18.3 lbs) packed

\* Design and specifications subject to change without notice for improvements.



# SCHEMATIC DIAGRAM

\* Design and specifications subject to change without notice for improvements.

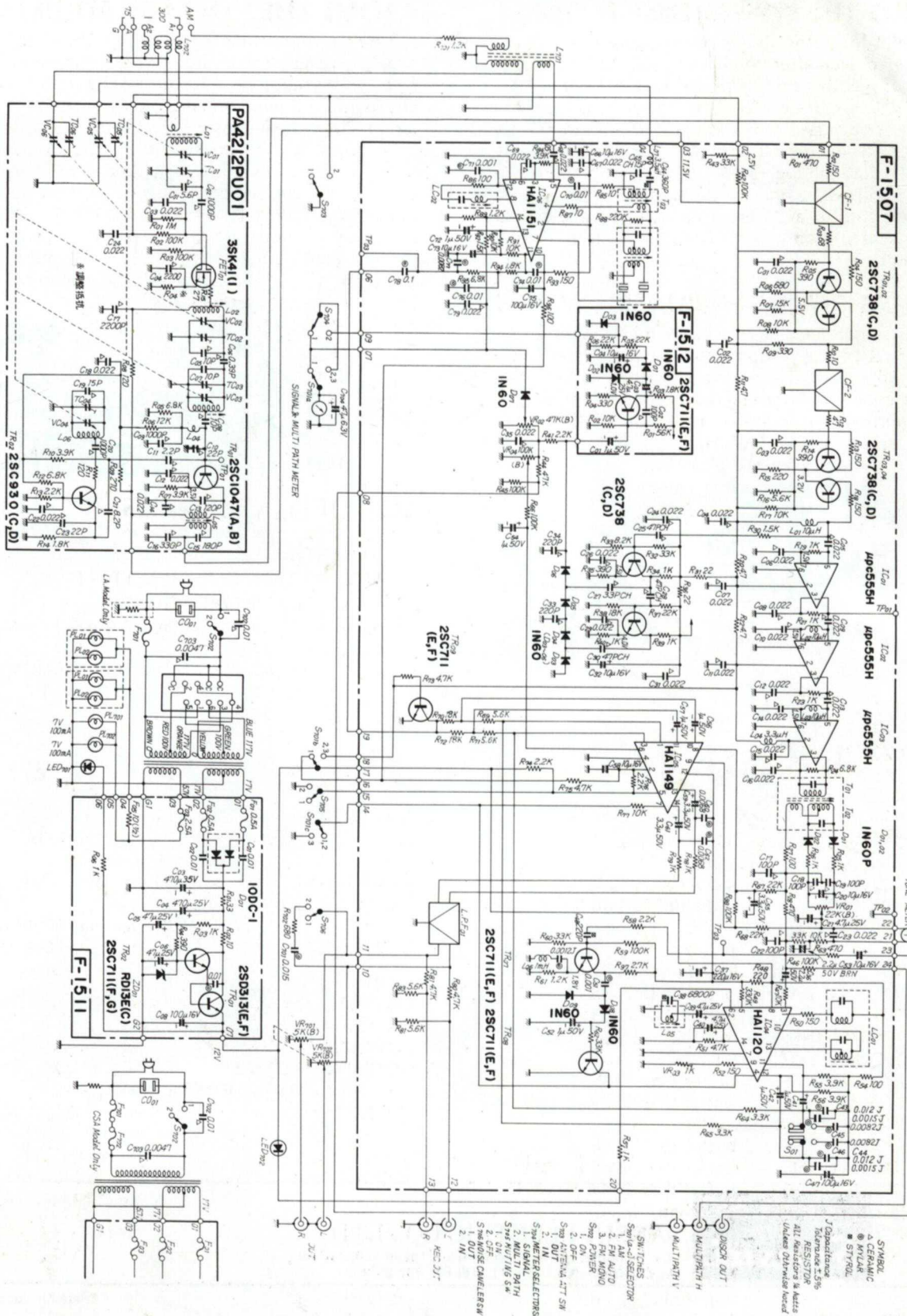



# SANSUI TU-7700 OPERATION

## SIGNAL AND TUNING METERS

Tune in the desired station while observing these meters. To use the SIGNAL meter to check the signal strength, the METER SELECTOR switch must be at the SIGNAL position. To use it to check the multipath reflection, the selector must be at the MULTIPATH position.

● **If you are tuning in an FM station:** Adjust the TUNING control first for maximum deflection of the SIGNAL meter on the right. Then adjust it so that the TUNING meter will indicate the exact center. The set will pinpoint the station and

receive it with optimum tonal quality.

● **If you are tuning in an AM station:** Simply adjust the TUNING control for maximum deflection of the SIGNAL meter. Ignore the TUNING meter when tuning on AM.

## FM STEREO INDICATOR

Lights when the tuner is tuned in on an FM station broadcasting in stereo.



## POWER SWITCH

Raise the lever switch to ON to turn the set on, push it down to OFF to turn it off.

## OUTPUT LEVEL CONTROL

Adjust the output signal level of the tuner. Turn clockwise to increase it.

### Important

As a rule, it is better to use the OUTPUT LEVEL control to match the tuner's output signal level with those of your turntable and tape deck, then adjust the over-all volume with the volume control of your amplifier.

## FM MUTING SWITCH

When turning on the FM band, noise is usually heard between stations which is peculiar to FM. Setting this switch to ON cuts off that noise and lets you tune quietly.

If you are trying to tune in a weak station, however, setting the switch to ON may cause the tuner to miss it. In that case, it is better to push the switch down to OFF and then tune.

## TUNING CONTROL

Tune in the desired station by turning this control.

## FM ANTENNA ATTENUATOR SWITCH

This switch selects the input sensitivity for FM stations. It should normally be at the OUT position. If while receiving an FM station, located in your vicinity, you hear too coarse or distorted reception due to excessively strong signal strength, however, flip the switch down to IN.

## MPX NOISE CANCELLER SWITCH

When you hear disturbing noise while receiving FM stereo broadcasts, push the switch down to IN; high-frequency noise will then be suppressed and the broadcasts will sound more pleasant. At all other times, however, the switch should be at its OUT position.

## SELECTOR SWITCH

This switch selects the band (AM or FM) that you want to hear.

**AM:** To receive AM broadcasts.

**FM AUTO:** To receive FM broadcasts, whether stereo or mono.

**FM MONO:** If the FM stereo reception is too noisy for pleasant listening, set the switch to this position. The broadcast will be received in mono but the noise will be substantially decreased.

## METER SELECTOR SWITCH

When receiving broadcasts, (to use the SIGNAL meter to check the signal strength), this switch should be at the SIGNAL position. To use it to check the multipath reflection, this switch must be pushed down to MULTIPATH: you can orient the antenna for the best FM reception. You are receiving optimum FM reception with the least multipath reflection when the SIGNAL meter deflects to the left. Therefore, tune in an FM station and then the antenna until the SIGNAL meter pointer swings as far to the left as possible before fixing it.

\*Multipath reflection: refer to the page 8 of the instructions for details.



# SANSUI TU-7700 CONNECTIONS

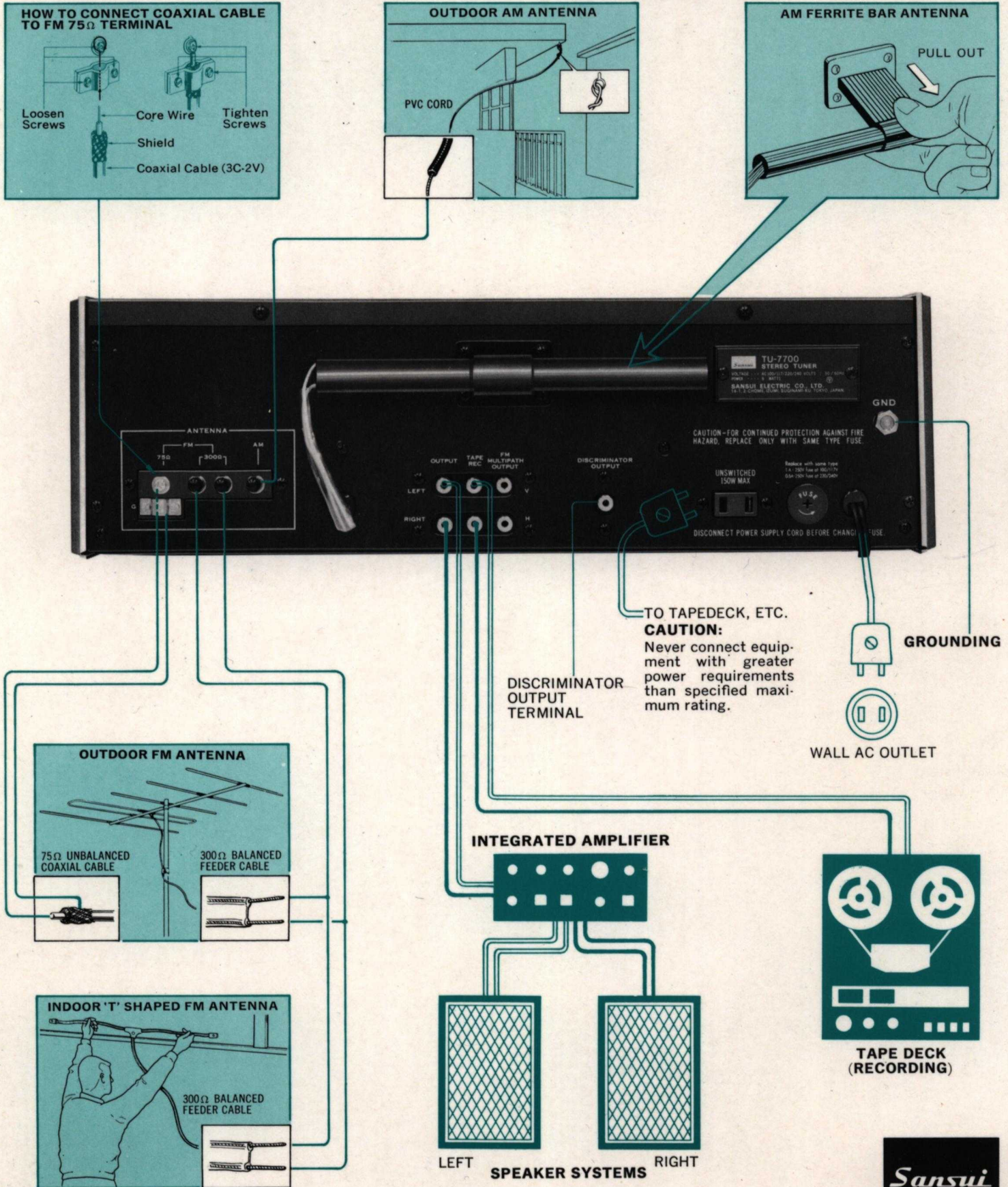

— LEFT CHANNEL  
— RIGHT CHANNEL

\* Design and specifications subject to change without notice for improvements.

**SANSUI ELECTRIC CO., LTD.**  
14-1, 2-chome, Izumi, Suginami-ku, Tokyo 168, Japan.  
TELEPHONE: (03) 323-1111/TELEX: 232-2076



Stock No. 9228350 Printed in Japan (64M100)



## SANSUI INTERNATIONAL WARRANTY

SANSUI ELECTRIC COMPANY, LTD., warrants all Sansui products purchased in one country and taken abroad against defects in materials and workmanship for the period(s) enumerated under "Terms of Warranty" from the original purchase date. Provided that the holder bears all costs for insuring the safe delivery and return of his equipment to and from the nearest authorized Sansui service station, repairs and parts replacement will be made without charge anywhere in the world, subject to the following exceptions:

1. Failure to present both sales slip (or its equivalent) and this Warranty card.
2. Breakdowns or damage due to careless handling, negligence, accidents, abuse or failure to follow operating instructions furnished by Sansui.
3. Breakdowns caused by other appliances.
4. Breakdowns or damage due to natural disasters, acts of war or public disturbances.
5. Repairs, alignments, alterations or tampering with the product by individuals or service stations other than those specifically designated by Sansui in the accompanying list of International Authorized Service Stations.
6. Breakdowns or damage due to packaging and shipment in containers other than those provided or designated by Sansui.
7. Equipment with serial numbers altered or removed.

*Products to which the above exceptions apply will be serviced at cost to the owner.*

## TERMS OF WARRANTY

PRODUCTS	FREE LABOR	FREE PARTS	EXCEPTIONS
Receivers, Tuners & Amplifiers	12 Months	24 Months	A
4-Channel Synthesizer Decoders	12 Months	24 Months	A
Electronic Crossover Units	12 Months	24 Months	A
Reverberation Amplifiers	12 Months	24 Months	A
Turntables	12 Months	12 Months	B
Speaker Systems	12 Months	12 Months	C
Stereo Headphones	12 Months	12 Months	—
Stereo Systems	12 Months	12 Months	D
Tape Decks & Recorders	6 Months	12 Months	E

- A. With the exception of panels, knobs, bonnet, smoked plate and dial glass.  
 B. With the exception of stylus, knobs, head shell, acrylic dust cover and all wooden parts.  
 C. With the exception of all wooden parts.  
 D. With the exception of all wooden parts, panels, knobs, smoked plates, dial glass, head shell and stylus.  
 E. With the exception of all wooden parts, panels, knobs, smoked plates, meter covers, dust covers, tape heads, and all other parts listed as accessories.

This International Warranty is in lieu of all other Warranties expressed, implied or statutory and is made on the express understanding that it may be invoked only by the original purchaser and covers only those Sansui products purchased in one country and presented for servicing and/or repairs in another.

Proof of date of purchase is considered to be a responsibility of the customer and must be presented when applying for In-Warranty Service at an authorized SANSUI Service Station.

**IMPORTANT**  
KEEP YOUR SALES SLIP HERE

**Sansui**



MODEL:

TU - 7700

SERIAL NO:

22408

STEAM POWERED RADIO.COM

PRINTED IN JAPAN 9290040

INTERNATIONAL

---

# WARRANTY

Applicable only for Sansui products purchased in one country and presented for servicing in another.  
When no international shipment or travel is involved, only the original dealer's Warranty is applicable.

---



# CAUTION CARD

---

1. Never expose this amplifier to direct sunlight. Keep away from all thermal sources and heat generators.
2. Before turning the amplifier on, be sure the lead wires from the speakers are properly connected at both output and input terminals.
3. Before turning the amplifier on, be sure that all connections — antennas, pin-jacks, wires, etc. — are properly made for whatever component or program source to be employed.
4. Always minimize the amplifier's Volume Control when using the function Selector Switch or when turning on components. When changing connections between the amplifier and components, it is strongly recommended that the amplifier's AC power cord be removed from its AC outlet.
5. If there is no sound from the speakers, or the sound is distorted, turn down the Volume Control and disconnect the amplifier's AC power supply cord. Then trace the source of the trouble with the aid of the Operating Instruction supplied.
6. Never connect two or more speakers to one terminal. Doing so will cause serious damage.

## **note:**

For correct operation, follow our Operating Instructions manual.



---

The Sansui logo consists of the word "Sansui" in a stylized, italicized serif font, set against a solid black rectangular background.

SANSUI ELECTRIC CO., LTD.

14-1, 2-chome, Izumi, Suginami-ku, Tokyo 168, Japan.  
TELEPHONE: (03) 323-1111 / TELEX: 232-2076

---

Printed in Japan (64M100)