



HAM NEWS

NOVEMBER-DECEMBER, 1960

Also in this issue...

Scanning the Spectrum.....page 2

FINAL CALL — 1960 Edison
Radio Amateur Award.....page 7

Triple Triode Compactron
Devices Announcedpage 8

Copyright, 1960, by General Electric Company

MOBILE LINEAR AMPLIFIER...SEE PAGE 3

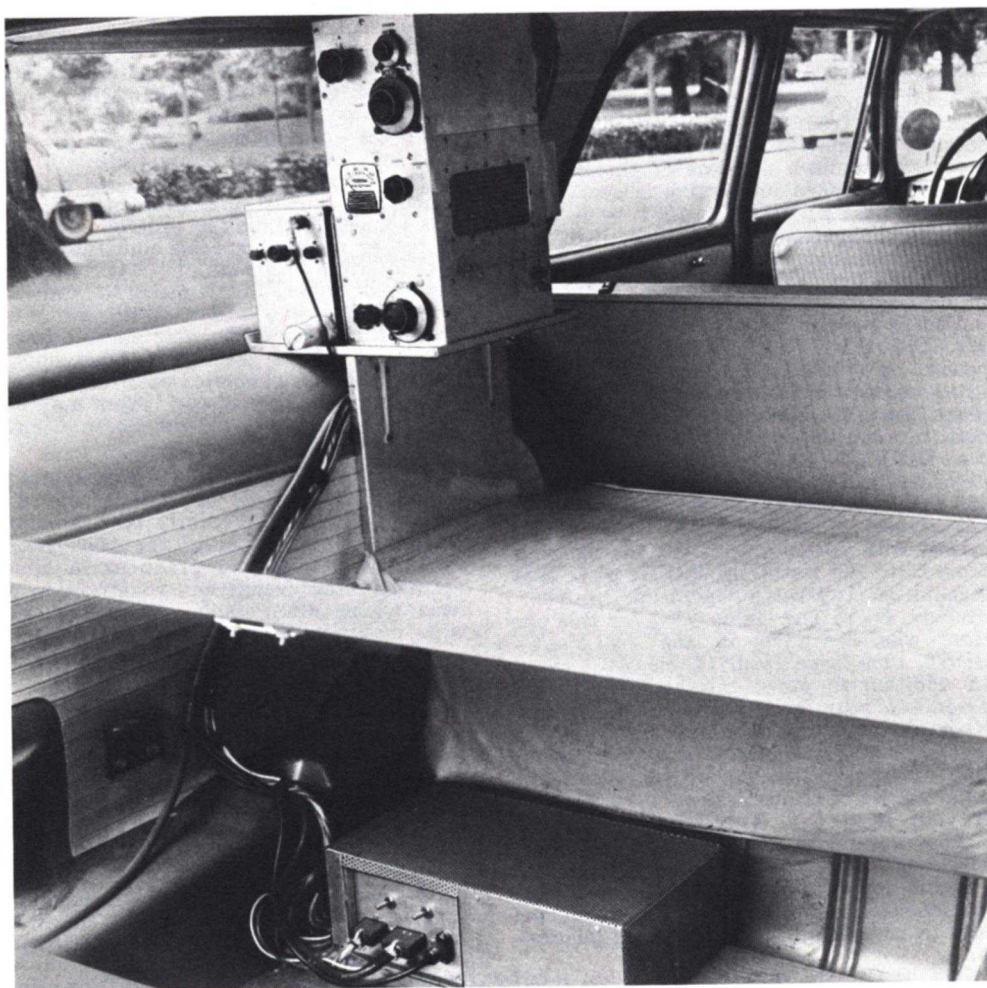

KILOWATT MOBILE LINEAR AMPLIFIER installed in W8WFH's station wagon over the left rear wheel housing. Power supplies delivering 2,500 volts DC for the 6L4D21/4-125A amplifier tube plates, and 600 volts DC for the screen grids, are in the metal

box under the floor. The metal box next to the amplifier contains a motor-driven, remote-tuned oscillator, heterodyning and driver stages for the amplifier. The SSB generator, and audio and VOX circuits are under the front seat.

If You Didn't Get This From My Site,
Then It Was Stolen From...

www.SteamPoweredRadio.Com

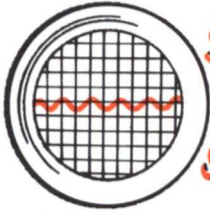

SCANNING the SPECTRUM

IN COMING ISSUES . . .

Starting with the January-February, 1961 issue, *G-E HAM NEWS* will be printed with a full 8½ x 11-inch page size, and continuing the standard 8 pages per issue. The larger page size will permit running schematic diagrams and other illustrations larger for greater clarity of detail. In addition, a standard 3-hole punch along the fold will be included, so that issues may be stored in a loose-leaf binder or notebook. Editorial space is increased more than 50 percent to bring our readers even more "How-to-do-it" ideas in each issue from the more than 999 radio amateurs in General Electric.

Here's a rundown of some of the key articles we've planned for coming issues:

JANUARY-FEBRUARY, 1961 — A combined audio preamplifier with built-in frequency response shaping and level limiting, called the "VOXI-MATIC" by W4PFQ of General Electric's Receiving Tube Department here in Owensboro;

MARCH-APRIL, 1961 — A compact, high-power, grounded-grid, linear amplifier using pentode tubes in the 60 to 150-watt plate dissipation class, for mobile or home-station operation, by W8DLL, co-author of the **MOBILE RADIO SYSTEMS** series described in this, and the past two issues;

MAY-JUNE, 1961 — A bandswitching heterodyne type exciter for 3.5 to 30 megacycles, with power output options ranging from 20 to 100 watts, by W2FBS of G. E.'s Machinery Apparatus Operation in Schenectady, N. Y. The stable VFO for this exciter was described in the **JULY-AUGUST, 1959** issue (Vol. 14, No. 4).

In addition to other interesting subjects later in the year, a new edition of our **DX LOG** is planned for the end of the year. The larger page size will permit a more complete listing of information on DX scores in the popular modes of transmission.

If your local G-E Tube distributor does not now receive a supply of *G-E HAM NEWS*, ask him to order copies from me. Or, if his supply runs out quickly, ask him to order more copies, so that all radio amateurs in your locality will have our publication.

NOTE: The disclosure of any information or arrangements herein conveys no license under any patents of General Electric Company or others. In the absence of an express written agreement to the contrary, the General Electric Company assumes no liability for patent infringement (or any other liability) arising from the use of such information by others.

AIDS FOR AMATEURS . . .

We often run across handy operating aids and gadgets of interest to radio amateurs and call attention to them in this column. Here are some of the latest items:

Global Time Conversion Simplifier — a chart which unfolds to 17 x 22 inches in size, which will help radio amateurs establish the correct local time at almost any specific point on earth. It contains an easy-to-use charting of complete global time information, and even has a listing of time data for major cities in the United States — even our home QTH of Owensboro, Ky. Look for it at electronic parts distributors which handle John F. Rider publications.

New Call-Letter Sign — a 2½ x 7-inch call-letter sign, with letters permanently embossed in sheet aluminum, can be mounted on the rig, car, bicycle, ham shack door, etc. Finished in baked enamel, the call letters are reflectorized with glass beads for good nighttime visibility. A postal card to Redicraft Products, Box 1244, Studio City, Calif., will bring you details.

Call-D-Cal — a handsome decal in six colors with call letters and home state will adhere to any smooth surface, including glass. Excellent for identifying your mobile station, this 4 x 8½ decal may be ordered individually, or ten or more at special club rates. Obtain details from Call-D-Cal, P.O. Box 3915, Terminal Annex, Los Angeles 54, Calif.

Call-Letter Jewelry — one of the many items personalized for radio amateurs; others include ties, plates, tie clasps, lapel pins, ash trays, pencil caddies, etc., all with call letters on them. Complete catalog listing may be obtained from K9TVA, 6429 North Glenwood Avenue, Chicago 26, Ill.

ARRL ANTENNA BOOK — A completely revised Ninth Edition of the famous ARRL Antenna Book has recently been announced. Expanded to 320 pages, the book presents the latest trends and practices in amateur radio antenna design and construction problems which often cannot be solved simply with manufactured equipment. The book is available from electronic parts distributors, or directly from ARRL.

EMERGENCY POWER SOURCE . . .

The 3-phase AC alternator system described in the July-August, 1960 issue is a good source of emergency power, according to W8DLL. As long as the load on the alternator is closely balanced, a kilowatt of power is available for lighting, running appliances, and even AC-powered communication equipment in an emergency. For the latter application, it is best to hold the engine speed below 1,000 r.p.m. so that the alternator frequency does not go above 200 cycles. Transformers in some equipment designed for 60-cycle operation may not operate efficiently on frequencies above this.

73 until our first "King-Size" issue,

— *Lighthouse Larry*

MOBILE LINEAR AMPLIFIER

By W. C. Louden, W8WFH

STABILITY AND RELIABILITY are of prime importance in mobile radio equipment. This well-shielded linear amplifier meets these requirements and has components rated for a full kilowatt DC input in class AB₁ or AB₂ operation. It is also well-suited for home-station installations.

The high power sensitivity of modern tetrode and beam pentode transmitting tubes simplifies the construction of an amateur transmitter since they require only low driving power, and thus, a simple exciter. Two

GL-4D21/4-125A tetrodes were connected in parallel in this amplifier in a tuned-grid, tuned-plate circuit, as shown in the schematic diagram, Fig. 1.

COMMERCIALLY MADE GRID AND PLATE tank circuits, as specified in TABLE I — PARTS LIST, were found to have the correct inductances for the grid and plate circuits over the range of 3.5 to 30 megacycles. The plate pi-network loading capacitor C₄ is a standard 3-gang broadcast type variable. (continued on page 4)

TABLE I — PARTS LIST MOBILE LINEAR AMPLIFIER

- | | |
|--|---|
| C ₁10 — 200-mmf variable (Part of Harrington GP-50 tuned circuit). | M ₁0 — 50-milliampere DC milliammeter (G.E. Model DW-91, or equivalent). |
| C ₂1-11-mmf neutralizing capacitor. | R ₁ , R ₂0.667 ohms, 2 watts; resistance wire wound on 2-watt resistors. |
| C ₃15-250-mmf variable, 3,000 volt spacing. | RFC ₁ , RFC ₃2.5-milihenry, 4 pi r.f. choke, 125-milliampere rating. |
| C ₄30 — 1140-mmf variable (3-section broadcast receiver capacitor with 10 — 380-mmf per section). | RFC ₂200-microhenry solenoid wound r.f. choke (National R-175A, or Barker & Williamson No. 800). |
| J ₁ , J ₂chassis coaxial cable connectors. | S ₁2-pole, 5-position ceramic rotary tap switch (Part of GP-50). |
| L ₁grid coil assembly (part of GP-50). | S ₂1 pole, 5-position tap switch (Part of B & W 851 coil). |
| L ₂10-microhenry coil with taps and switch S ₂ (Barker & Williamson Model 851 pi-network tank circuit). | S ₃2-pole, 5-position rotary tap switch. |
| L ₃ , L ₄ , L ₅ , L ₆ , L ₇parasitic suppressor chokes made from 6 turns of No. 16 enameled wire on 2 watt, 47-ohm composition resistors. | T ₁ , T ₂5-volt, 6.5-ampere filament transformers, 12 or 115-volt primaries. |

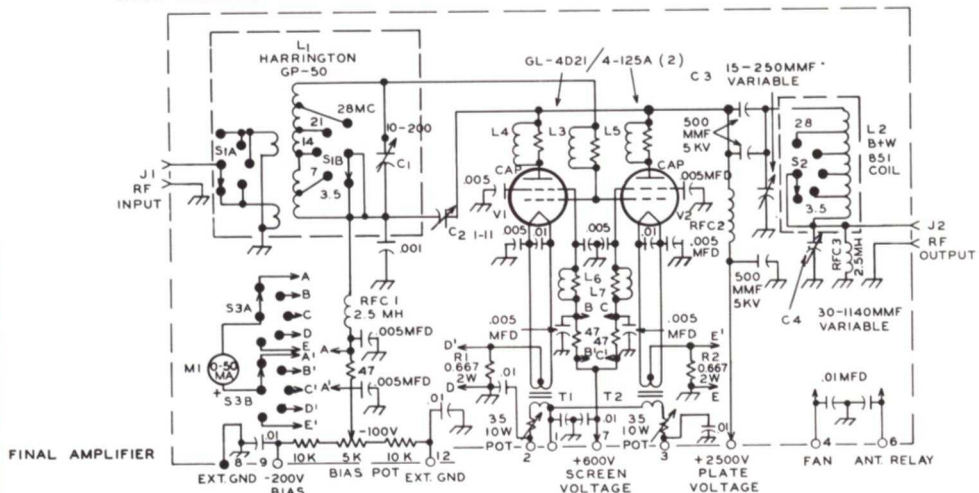

FIG. 1. SCHEMATIC DIAGRAM of the GL-4D21/4-125-A mobile linear amplifier. The 0.001, 0.005 and 0.01-mfd capacitances shown as bypasses in various circuits are disc ceramic capacitors, with DC voltage ratings at least double the operating voltage of each circuit. Resistances are in ohms, 1/2 watt rating unless otherwise specified. Components C₁, L₁ and S₁ are included in the Harrington GP-50 grid tank circuit; L₂ and S₂ are included in the B & W 851 pi-network plate tank circuit.

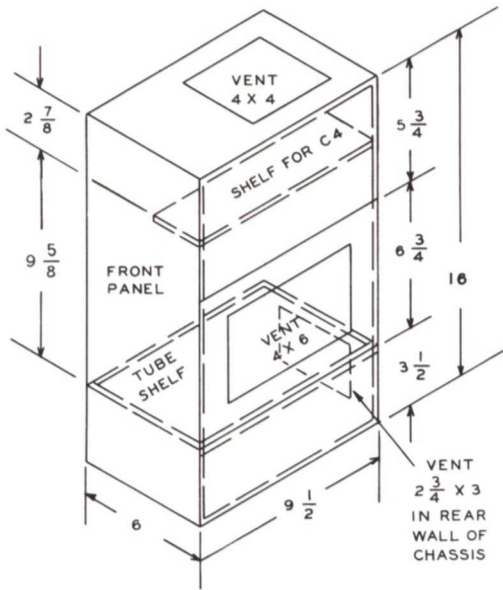

FIG. 2. CABINET DRAWING for the mobile linear amplifier. This cabinet was fabricated from $\frac{1}{16}$ -inch thick sheet aluminum, with flanges for side shields.

(continued from page 3)

Capacitive bridge neutralization was included in the circuit to ensure stability on all bands. This bridge is formed by the tube capacitances, plus C_2 and the 0.001-mfd capacitor from C_1 to ground.

Separate current metering was provided for the screen grid and cathode circuits of each tube to check on the balance of power between them. A 0 to 50-milliamper DC current meter is switched across resistors in the control grid (A) and screen grid (B & C) metering positions of S_3 . In the cathode circuits (D & E), 0.667-ohm shunts multiply the meter reading by 4 times for a full scale reading of 200 milliamperes in each circuit. If the separate metering of cathode currents is not necessary, a single filament transformer may be used.

If GL-4-250A/5D22 or GL-4-400A tetrodes are used in this amplifier, larger filament transformers are needed. Also, if these tubes will be operated near maximum power, a heavier plate tank coil, the B & W Model 850A, which requires more space, should be substituted for the Model 851 coil. Type GL-813 pentodes also may be used in this amplifier by installing the proper sockets and filament transformers.

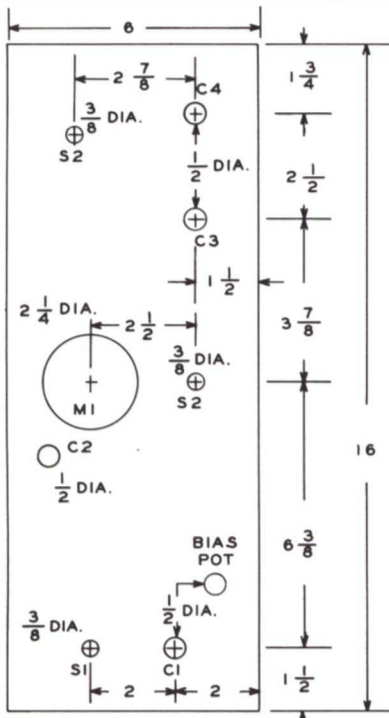
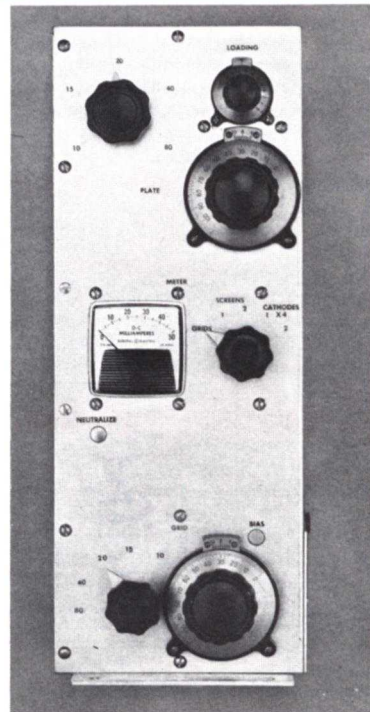

FIG. 3. PANEL LAYOUT DIAGRAM for the amplifier. Only major hole locations are shown. Locations of small holes for hardware should be located from the part being mounted. Cut meter hole to a diameter slightly larger than case of meter.



PANEL VIEW of the linear amplifier. Note that grid and plate bandswitches have separate knobs, and are not ganged. Snap-in buttons cover the holes through which the neutralizing capacitor (C) and bias potentiometer are adjusted.

THE SHIELDED ENCLOSURE for the amplifier, shown in Fig 2, was fabricated from $\frac{1}{8}$ -inch thick sheet aluminum. All sides were made as separate pieces with flanges on them for assembly to adjacent pieces with machine screws and nuts, or self-tapping screws. The shelves and vent holes should be added before holes are cut for mounting the components. Vent holes may be covered with aluminum screening or perforated sheet.

The front panel layout, Fig. 3, and the sub-chassis shelf layout, Fig. 4, are correct for the components specified in the PARTS LIST. Holes should be relocated to suit other brands of components as necessary. Locations for small parts can be determined from the pictures.

Although no commercially made enclosure of similar dimensions is available, a 6 x 10 x 3-inch aluminum chassis or Minibox (Bud CU-3010) could be used as a chassis base and fitted with the 6 x 16-inch front panel. A frame of aluminum angle covered with perforated sheet aluminum would make a good r.f. shield and support the upper shelf.

COMPONENT SUBSTITUTIONS may be made, as long as their electrical and mechanical characteristics are similar. The neutralizing capacitor, C_2 , may be a Bud NC-853, Millen 15011, or Johnson 159-125. Or, a suitable capacitor may be made by mounting two aluminum plates about 1 x 4 inches spaced about $\frac{1}{2}$ inch apart on standoff insulators.

The upper shelf may be dropped about an inch if necessary to allow room for a larger B & W Model 850A plate tank circuit which should be used with the larger tubes. The vernier tuning dials for the grid and plate circuits are Lafayette type F-346, 3 inches in diameter. National type AM dials also are suitable.

Power wiring was run with insulated wire of sufficient size to carry the voltages and currents in the various circuits. Leads carrying the grid and plate r.f. currents should be of $\frac{3}{32}$ x $\frac{1}{2}$ -inch copper strip. In the plate tank

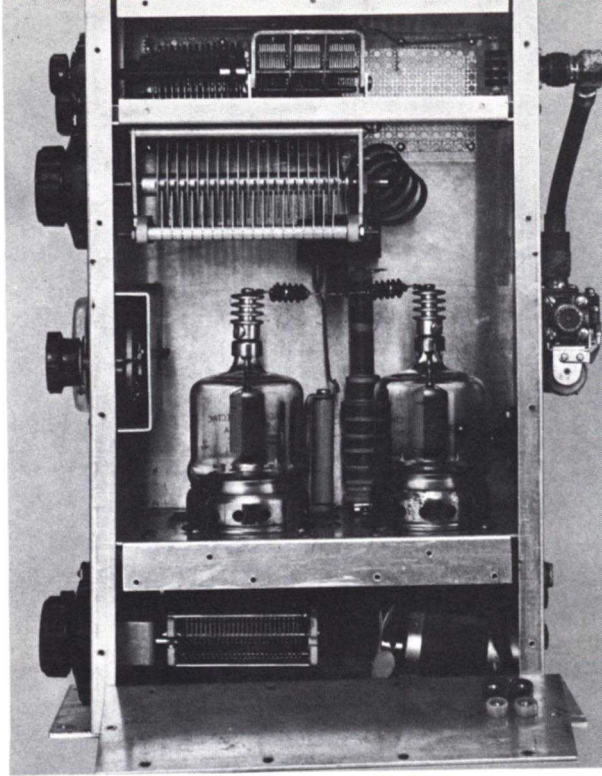

SIDE VIEW of the amplifier. A "U" shaped bracket (Bud CB-1628 miniature chassis) behind the panel shields the meter (M_1) and meter switch (S_2) from strong r.f. field present around the plate tank circuit.

circuit, use joints fastened with brass machine screws instead of solder when possible.

The fan shown is simply a small 12-volt DC motor with a fan blade. It pulls cool air into the chassis through the $2\frac{3}{4}$ x 3-inch vent in the chassis, forces it up through the holes in the tube sockets, and out through the upper vents in the box.

The antenna changeover relay was mounted on the outside of the cabinet where it would be easily accessible. Power for the

(continued on page 6)

FIG. 4. SUB-CHASSIS LAYOUT diagram. Socket hole diameter ($2\frac{3}{4}$ inches) is for Johnson 122-275-1 sockets, and may be different for other brands of giant 5-pin wafer sockets designed for GL-4D21/4-125-A and similar tubes. Socket hole spacing is sufficient to permit using the higher plate dissipation GL-4-250A/5D22 and GL-4-400A tetrodes in the amplifier if desired.

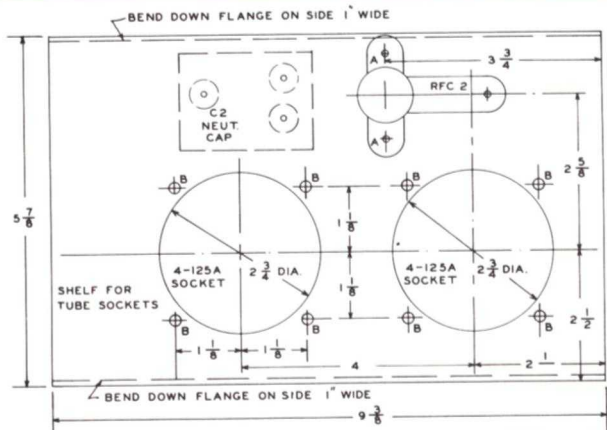

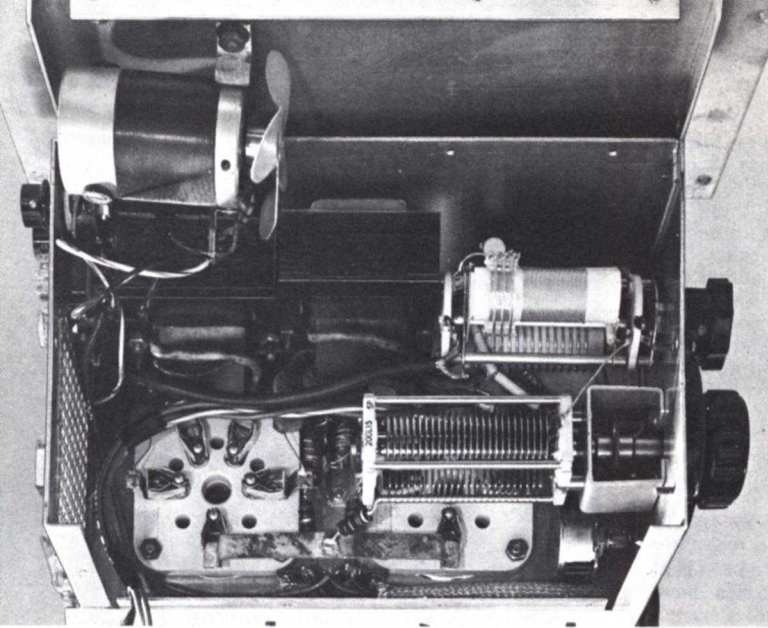

BOTTOM VIEW of the linear amplifier. Note $\frac{3}{8}$ -inch wide copper strip connection between the control grid terminals on the tube sockets. Fan under the chassis forces air up through holes in the tube sockets, due to tight construction of lower part of box. Air cools seals in bases of tubes, then passes out through holes in bases and up along glass envelopes.

**BIBLIOGRAPHY OF
INFORMATION ON LINEAR
AMPLIFIER TESTING**

"Adjustment of Class B Linear Amplifiers," *RADIO HANDBOOK*, 14th Edition, by Editors and Engineers, page 278.

"Two Tone Tests and Their Meaning," by Don Stoner, W6TNS, *NEW SIDEBAND HANDBOOK*, page 151.

"How to Test and Align a Linear Amplifier," by Robert W. Ehrlich, WØJSM, *SINGLE SIDEBAND FOR THE RADIO AMATEUR*, page 134; also in *QST*, May, 1952, page 39; and the *RADIO AMATEUR'S HANDBOOK*, page 314.

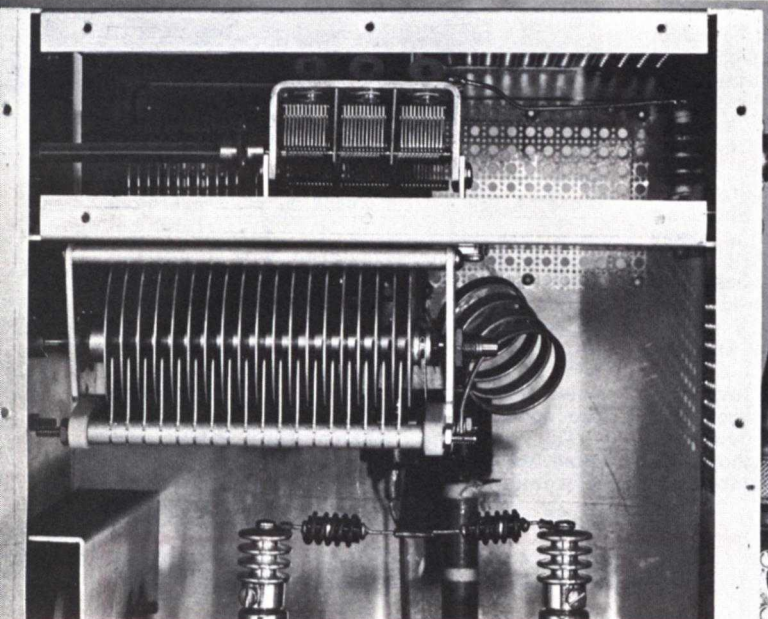

PLATE TANK CIRCUIT of the linear amplifier. Plate tuning capacitor, C_3 , is suspended from shelf, with pi-network loading capacitor C_4 mounted on shelf. The 28-megacycle coil was removed from the B & W Model 851 pi-network tank circuit frame and mounted between C_3 and the other section of coil. L_2 is mounted upside down from the top of the cabinet.

(continued from page 5)

relay coil was brought into the amplifier through the 12-pin plug (Jones P-312-AB) along with the other low and medium voltage circuits. Bypass capacitors were connected to each pin on this plug, as well as used liberally throughout the amplifier, to keep r.f. currents off the power wiring.

INITIAL TESTING should preferably be done in a home station where checks and adjustments can be made more easily than in a vehicle. The test setup should preferably have a dummy antenna load, and have provision for reducing and turning off plate and screen voltages. First apply filament power, bias voltage and r.f. excitation to the am-

plifier so that the neutralizing adjustment can be made. About 5 watts of r.f. excitation at 14 megacycles or higher is necessary. This will give a grid current reading of 10 to 15 milliamperes.

Set S_2 in position "A" and tune the grid circuit for maximum current, making sure that the grid and plate bandswitches are in the proper position. Then, with loading capacitor C_4 near maximum capacitance, "rock" the plate tuning capacitor, C_3 , back and forth, watching for a quick fluctuation in grid current at one point on the dial for C_3 . Adjust the neutralizing capacitor, C_2 , until the grid current is constant.

FINAL CALL— 1960 EDISON RADIO AMATEUR AWARD

January 2, 1961, is Deadline for Nominations

Emergency communications, community service, relaying messages, civil defense organizational work, helping disabled persons, amateurs and others with specialized problems; these are typical activities that qualify United States radio amateurs for the Edison Radio Amateur Award. Full details are available on request.

Only candidates whose names are submitted by letter can be considered by the Award judges, there is no other source for nominations. Help bring national recognition to a worthy amateur, and the hobby of amateur radio. Send in your nominating letter promptly to Edison Award Committee, General Electric Company, Electronic Components Division, Owensboro, Kentucky.



As a final check for neutralization, remove the r.f. drive, apply about half of normal plate and screen voltages, and reduce the grid bias so that the plate current increases to near maximum plate dissipation for the tubes used. Rotate both the grid and plate tuning capacitors to see if the amplifier will break into oscillation at any combination of settings. This test should be tried on all bands. If an oscillation is noticed, readjust C_2 slightly until the oscillation disappears.

After turning off power, connect the amplifier to a suitable dummy antenna load having a 50-ohm impedance and power capability of at least 500 watts. Insert a standing wave ratio bridge in the coaxial cable between the amplifier and dummy antenna. Apply r.f. drive, and about half of normal plate and screen voltages, and tune the amplifier for maximum output.

If the amplifier appears to function normally, apply full plate and screen voltages. Adjust C_4 so that each tube draws about 150 milliamperes plate current (for GL-4D21/4-125A tubes). Check to see if maximum power output on the SWR indicator occurs at the same setting of C_3 as the minimum plate current dip. Any major differences in plate or screen currents drawn by each tube indicates that one tube may be better.

Preferably, a SSB exciter should be used to drive the amplifier, so that linearity tests can be run on the amplifier before installation in the vehicle. If excess driving power is available from the exciter, a 5,000-ohm, 25-watt non-inductive resistor (Sprague 25NIT-5000 or equivalent) can be connected across C_1 to swamp the excess drive. Complete descriptions of linearity tests are given in the amateur radio handbooks, as listed in the bibliography on page 6.

INSTALLATION IN THE VEHICLE is simply a matter of mounting the amplifier securely so

that it will not shake or vibrate excessively while the vehicle is in motion. Connect each filament transformer primary across a different phase of the 3-phase AC power source in the vehicle. Heater power for the exciter should be obtained from the third phase to balance the heater load.

In W8WFH's installation, bias voltage is obtained from a small 200-volt negative single-phase AC supply, while 600 volts for the GL-4D21/4-125A screen grids is delivered by a 300/600-volt 3-phase star bridge rectifier supply which also powers the exciter from the 300-volt tap (Fig. 9 on page 7 of the July-August, 1960 issue). A 2500-volt 3-phase plate supply is used, but plate voltages up to 3000 are suitable.

W8WFH does not recommend regulating the bias and screen grid voltages for the amplifier. Plate voltage may fluctuate more than 10 percent due to variations in the alternator output voltage with engine speed — from 100 volts at idle, to 120 volts at road speeds — and plate current peaks during modulation. By allowing the bias and screen grid voltages to fluctuate in accordance with the plate voltage, a fairly *constant ratio* is maintained among these three voltages, and amplifier linearity is improved.

A husky mobile antenna is required for this amplifier. W8DLD and W8WFH have constructed their own antennas with separate center-loading coils for each band. Details will be published in a forthcoming issue. Check with the manufacturer of the mobile antenna you may be considering, to ensure that it will withstand the several hundred watts of power output delivered by this amplifier.

If you want real performance in your mobile amateur radio installation, follow the proven recommendations published in this 3-part series in *G-E HAM NEWS*.

**TRIPLE
TRIODE**

COMPACTRON

**DEVICES
ANNOUNCED**

New 6C10 and 6D10 feature separate element connections via 12-pin base

TWO TRIPLE TRIODES are the first types to be registered in General Electric's new line of "Compactron" multi-function devices. Only 1½ inches in seated height (see view at right), these devices feature separate connections to all elements via a new 12-pin base. Previous triple triodes with 9-pin miniature bases (6EZ8 and 6GY8) each had combined element connections to some pins.

One type, the 6C10, contains three triode sections, each with characteristics similar to a section in the 12AX7 high-mu twin triode. The 6D10 has sections similar to the 6AB4 single, and 12AT7 medium-mu twin triodes. This permits the 6C10 and 6D10 to be used in present circuits without redesign, and where three separate triode functions are required. Both tubes have 6.3-volt heaters.

In addition to the usual applications in resistance coupled amplifiers, phase inverters, automatic frequency control service, and combined mixer-oscillator-grounded grid r.f. amplifiers in FM receivers, the following typical amateur radio circuits may be combined in a single triple triode "Compactron" device: VHF Converter — grounded-grid r.f. amplifier, mixer and oscillator; Product Detector — circuit requiring three triodes; Twin Triode Product Detector and AVC Amplifier. VHF Exciters — crystal oscillator, first and second frequency multipliers, and Cascode r.f. Amplifier and Triode Mixer.

These are just a few of the many multi-function ideas possible with these and other new "Compactron" devices.

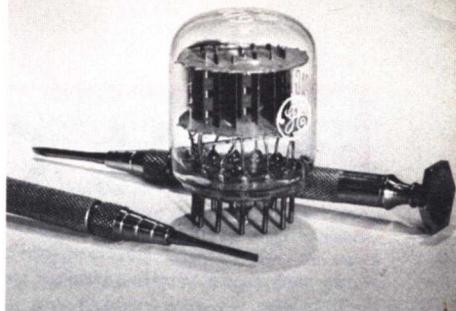

BASING DIAGRAM — EIA 12BQ

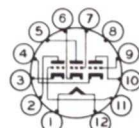

TERMINAL CONNECTIONS

- Pin 1 — Heater
- Pin 2 — Plate (Section 3)
- Pin 3 — Cathode (Section 3)
- Pin 4 — Cathode (Section 1)
- Pin 5 — Plate (Section 2)
- Pin 6 — Cathode (Section 2)
- Pin 7 — Grid (Section 2)
- Pin 8 — Internal Connection
- Pin 9 — Grid (Section 1)
- Pin 10 — Plate (Section 1)
- Pin 11 — Grid (Section 3)
- Pin 12 — Heater



NOVEMBER-DECEMBER, 1960
VOL. 15 — NO. 6

HOW-TO-DO-IT IDEAS
from the 999 radio amateurs at

GENERAL ELECTRIC

published bi-monthly by
RECEIVING TUBE DEPARTMENT
Owensboro, Ky.

**Available FREE from your
G-E Tube Distributor**

E. A. Neal, W4ITC — Editor

If You Didn't Get This From My Site,
Then It Was Stolen From...

www.SteamPoweredRadio.Com