

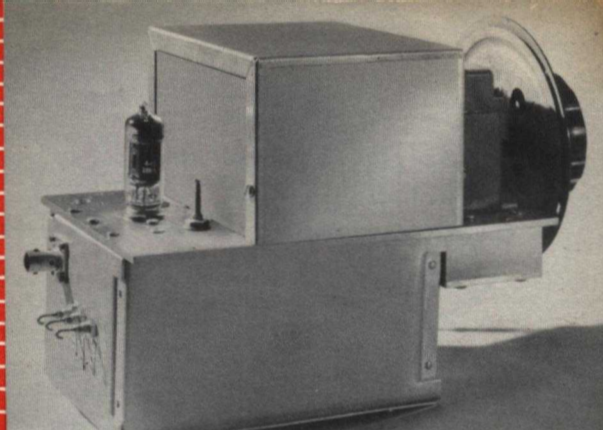

HAM NEWS

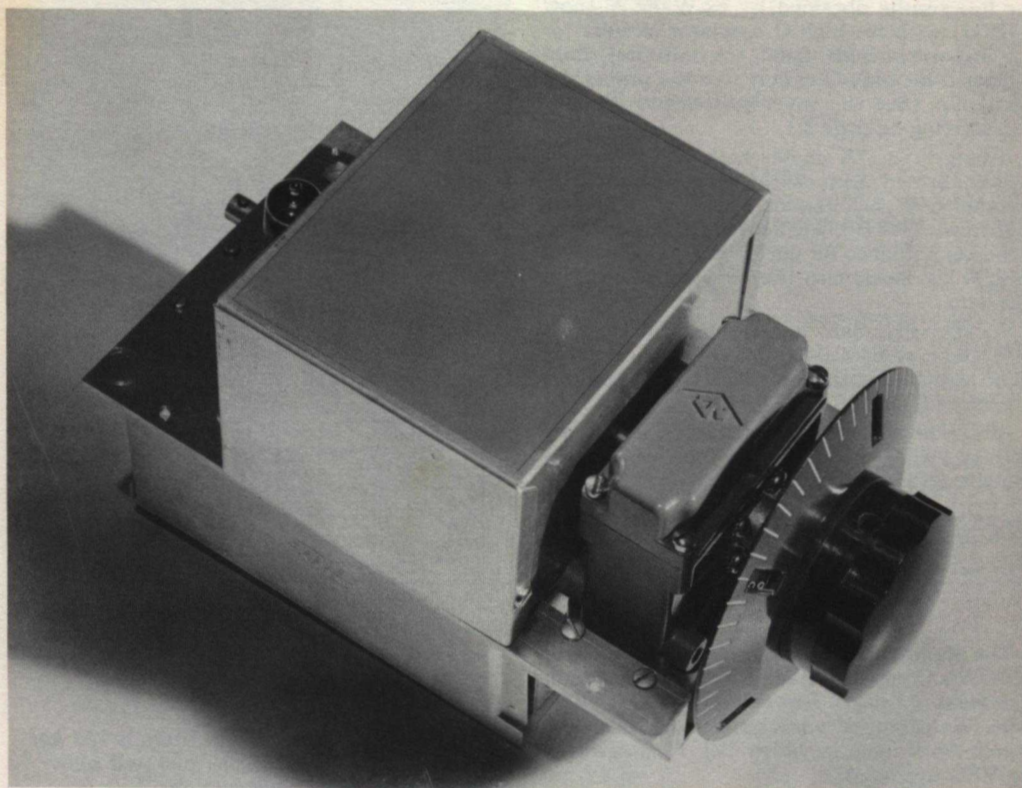

JULY-AUGUST, 1959



In this issue

SOLID HIGH-C VFO

.page 3

Here's a double feature issue—with Part II of our 200-watt DOUBLE SIDEBANDER; and—in response to many requests—details on constructing a solid high-C VFO for the popular amateur frequency ranges.

—*Lighthouse Larry*

Also—
Scanning the Spectrumpage 2
200-watt DOUBLE SIDEBANDER
(Part II)page 5
1959 Supplement to DX LOG ISSUE .page 7
TECHNICAL INFORMATION—6EZ8 . .page 8
Copyright 1959, General Electric Co.

If You Didn't Get This From My Site,
Then It Was Stolen From...

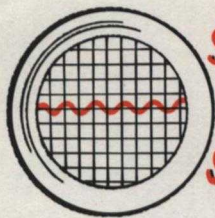

SCANNING the SPECTRUM

a new concept in electronic tubes and circuits

TIMMS

(Thermionic Integrated Micro Modules)

MEET THE DESIGNER . . .

W2FBS—Sam Johnson, needed a stable, tunable oscillator covering a single frequency range for the new heterodyne exciter he was building for his station. Having seen first hand the fine results obtained by ex-W2FZW (now K7BGI) with his high-C oscillator circuits for our 150-watt single band transmitters¹, Sam packaged his high-C circuit like the proverbial battleship. (See the cover photos and description starting on page 3.)

A long-time DX chaser with 230-odd countries confirmed, Sam can be heard almost daily on the CW DX bands, seeking new rare countries. W2FBS, incidentally, provided the technical guidance for our SPECIAL DX LOG ISSUE last year; also the 1959 supplement in this issue.

Vocationally, Sam is a mechanical engineer with General Electric's Gas Turbine Department at our king-sized manufacturing plant in Schenectady, N. Y.

After Sam's heterodyne exciter has a bit more mileage on it—and countries too—we'll bring you the details in a future issue.

¹See G-E HAM NEWS, November-December, 1957 (Vol. 12, No. 6) for details on this oscillator and transmitter.

COMING NEXT ISSUE . . .

The photo below is an operator's eye view of K2IOW's Compact Triode Kilowatt featured in a special 12-page September-October, 1959 issue. We promised you this fine article in the March-April issue in which Bob's bandswitching VFO appeared.

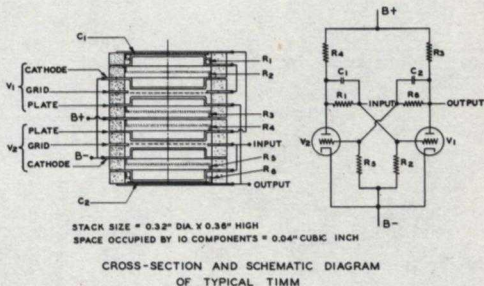
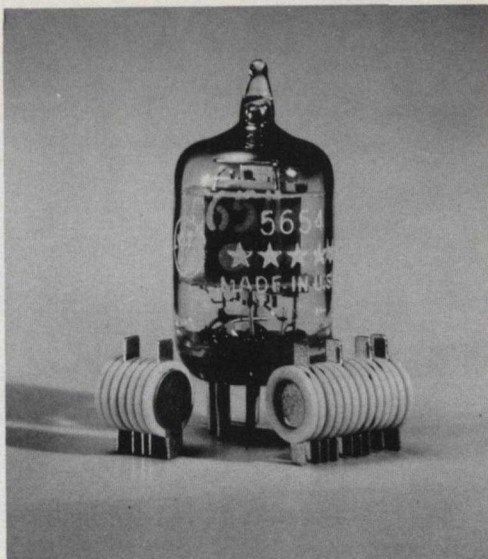

Amateur radio gear may be literally *red hot* in the future if TIMMS, as pictured above, are employed in its construction.

TIMMS circuits are a new concept of self-heating combination of heaterless electronic tubes, resistors, capacitors and other parts fabricated into stacks, shown above.

A complete circuit, such as the multivibrator in the sketch, occupies a space no larger than a pencil eraser. Once heated initially, the circuit generates its own operating temperature of 580 degrees C.

TIMMS are not yet commercially available, but if you'd like more information, we'll send you a bulletin describing them.

—Lighthouse Larry

SOLID HIGH-C VFO

CHOOSE YOUR TUNING RANGE and build this completely shielded, stable oscillator for your new multiplying type, or heterodyne type, exciter.

There's a great many possible combinations of frequency-determining components for the high-C oscillator circuit. Several ranges for the popular amateur frequencies are covered here, along with constructional details for variable frequency oscillators with excellent mechanical rigidity. The oscillator shown was designed to be mounted in a hole cut in a larger chassis, with a rubber bushing under each corner.

The basic circuit, shown in the schematic diagram, FIG. 1, is essentially similar to our

(Continued on page 4)

TABLE I: PARTS LIST

- C₁... air variable with front and rear rotor bearings; see TABLE II for capacitance values (Bud or Hammarlund "MC" or Johnson "R" series).
- C₂, C₃... silvered mica or zero-temperature; see TABLE II, for capacitance values.
- C₄... silvered mica; 100 mmf above 5 megacycles in grid circuit; 200 mmf below 5 megacycles.
- C₅... 100-mmf silvered mica (use only for capacitive coupled output circuit).
- C₆... silvered mica; see TABLE II for values.
- J₁... chassis type coaxial cable connector.
- L₁... coils 1 inch long, wound on 1/2-inch diameter ceramic iron-slug tuned coil forms 2 1/2 inches long (CTC LS-7, or PLS7-2C4L); see TABLE II for inductance values and turns.
- L₂... CTC LS-3 ready-wound coils; or, wound on same forms as L₁; see TABLE II. Wind 2-turn coil over L₂ for link.
- RFC₁... pi-wound r.f. choke, 2.5 mh below 5 megacycles, 1 mh above 5 megacycles (National R-50, or equivalent).

TABLE II—TUNED CIRCUIT COMPONENT VALUES

FREQUENCY RANGE		CAPACITORS			COILS—WINDING LENGTH = 1 INCH			
"A" (MC)	"B" (MC)	C ₁ (mmf)	C ₂ , C ₃ (mfd)	C ₆ (mmf)	L ₁ (uh)	TURNS	L ₂ (uh)	TURNS
1.75—1.88	3.5— 3.76	15—300	0.004	30	3.0	18	30—70	CTC LS-3 5-MC Coil
3.5 —4.0	3.5— 4.0	15—300	0.002	30	1.6	12	30—70	CTC LS-3 5-MC Coil
5.0 —5.5	5.0— 5.5	10—230	0.002	20	0.9	9	30—70	CTC LS-3 5-MC Coil
3.5 —3.75	7.0— 7.5	10—230	0.0025	50	1.3	11	6—13	CTC LS-3 10-MC Coil
3.5 —3.72	7.0— 7.44	15—300	0.004	50	0.9	9	6—13	CTC LS-3 10-MC Coil
6.0 —6.5	6.0— 6.5	10—200	0.002	20	0.6	7	14—20	44 on LS-7 Coil Form
6.0 —6.25	12.0—12.5*	8—140	0.0025	20	0.5	6	5— 9	22 on LS-7 Coil Form
7.0 —7.2	14.0—14.4	8—140	0.002	20	0.5	6	4— 8	19 on LS-7 Coil Form
8.0 —8.22	24.0—24.66	6—100	0.002	60	0.35	5	0.5—1.0	CTC LS-3 30-MC Coil
8.33—8.66	25.0—26.0	6—100	0.002	60	0.35	5	0.5—1.0	CTC LS-3 30-MC Coil

FIG. 1. SCHEMATIC DIAGRAM of the high-C variable frequency oscillator. Components required to cover a given frequency range are listed in TABLE II. All capacitances are in mmf, unless otherwise specified. All resistances are in ohms, 1/2 watt (K=1000). Use either link coupling (L₂ and J₁) for the output; or capacitive coupling with C₅, depending on the driving requirements of succeeding stage.

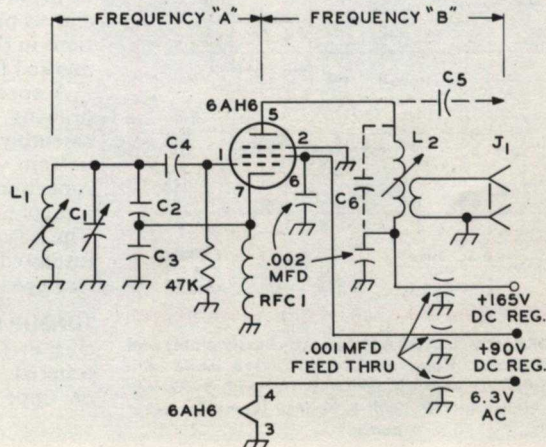

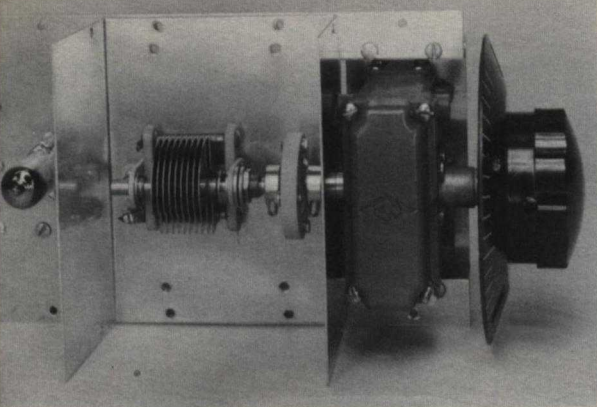

TOP VIEW of the oscillator with shield box over the tuning capacitor removed. Note how gear box on NPW dial fits into step-down shelf on chassis plate, permitting the dial shaft to line up with capacitor shaft. No spacers are used under feet on capacitor.

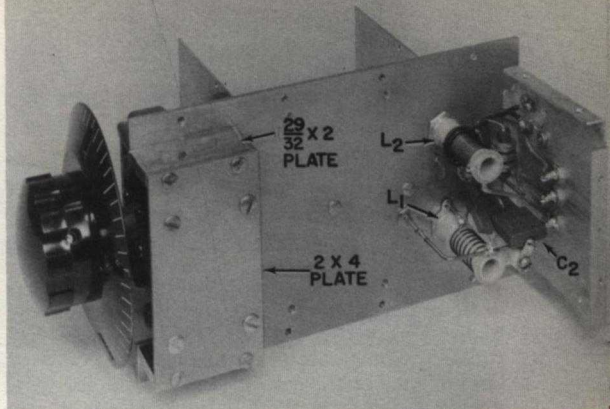

BOTTOM VIEW of the oscillator with bottom plate and side plates removed. The ceramic pillars for mounting C_2 and C_3 (see detail, FIG. 3) are just behind L_1 . The 0.001-mfd feedthrough capacitors for power connections are on the rear wall plate.

SOLID HIGH-C VFO

(Continued from page 3)

original high-C circuit (See "Technical Tidbits, High-C Oscillators," *G-E HAM NEWS*, November-December, 1957 Vol. 12, No. 6). Capacitors C_2 and C_3 form an r.f. voltage divider for feedback and also are in series across L_1 for determining the frequency of oscillation. The capacitance range of C_1 determines the frequency coverage.

A 6AH6 miniature pentode was chosen as the oscillator tube because of its high transconductance. The plate circuit (C_6-L_2) is usually tuned to the second harmonic of the grid circuit to lessen interaction caused by changes in load on the oscillator output. Details on the critical components are given in TABLE I. A choice of

component values for suggested tuning ranges is listed in TABLE II.

This particular oscillator was designed to cover an output tuning range of from 12.0 to 12.5 megacycles, a range of 500 kilocycles. With the National type NPW dial calibrated from 0 to 500, a tuning rate of about 1 kilocycle per dial division was achieved. However, the tuning rate was not precisely linear. A well-calibrated, smooth running tuning dial should be used on this—or any—VFO.

HIGH QUALITY insulation—steatite or ceramic—should be on the components selected for the oscillator wherever possible. This helps reduce frequency drift. The oscillator grid coil (L_1) had a measured "Q" of over 200 on the coil form specified, in spite of the small diameter.

CONSTRUCTIONAL DETAILS are covered in the photos and the drilling diagram for the chassis plate and shelf, FIG. 2. The shield box for C_1 is a 3 x 4 x 5-inch Minibox (*Bud CU-30*). The shield under the chassis plate was made from *See-Zak* aluminum expandable chassis parts. The front and rear side rails are *See-Zak R-34* (3 inches high, 4 inches long). A *See-Zak P-44* chassis plate forms the bottom cover. Hole locations in the chassis plate for this shield should be marked from the shield parts.

A special mounting, as shown in the detail drawing, FIG. 3, was made for C_2 and C_3 . This assembly is located next to L_1 , as shown in the bottom view. The three 0.001-mfd feedthrough capacitors for the power leads, and the r.f. output connector, (J_2), mount on the rear side rail. The power leads and link on L_2 were made with insulated hookup wire; tinned No. 12 bus wire was used for r.f. leads.

TUNEUP consists simply of adjusting the tuning slug in L_1 so that the desired tuning range is covered. A specific frequency at either the lower or upper end of the tuning range may be

(Continued on page 7)

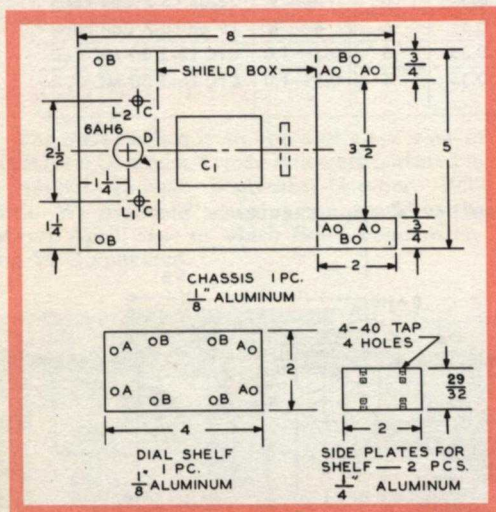

FIG. 2. DRILLING DIAGRAM for the chassis plate, and dial shelf plates. Holes marked "A" were made with No. 32 drill; "B" with No. 27 drill; "C" with 9/32-inch diameter drill; and "D" with a 3/8-inch diameter socket punch.

DOUBLE SIDEBANDER

Part II

CONSTRUCTIONAL DETAILS of the main chassis, and more operational data, are contained in the conclusion of this article on the latest in communication media.

The audio amplifier-modulator, control circuitry and power supplies for the 200-watt double sideband transmitter were constructed on a single 13 x 17 x 3-inch deep chassis (*Bud* AC-4, or equivalent). If the constructor desires, the power supplies could be built on a separate chassis—say 6 x 17 x 3 inches in size and attached in back of a 7 x 17 x 3-inch chassis for the audio section, and base for the r.f. unit.

Or, some constructors may prefer to utilize separate power supplies already available. If so the standard 7 x 17 x 3 or 8 x 17 x 3-inch chassis sizes will suffice. Tubes V_6 and V_9 can then be moved over in line with the audio tubes, and the whole line of tubes extended into the area occupied by L_7 .

Placement of major components on the main chassis is shown in the top and bottom views. No dimensions have been given, since the exact locations will depend on the sizes of the parts actually to be used in duplicating the transmitter. The same general configuration should be followed, since it has been found trouble-free.

Both control relays (K_1 and K_2) were located at the right side under the chassis, near the main power switch (S_1), fuses (F_1 and F_2), and the AC

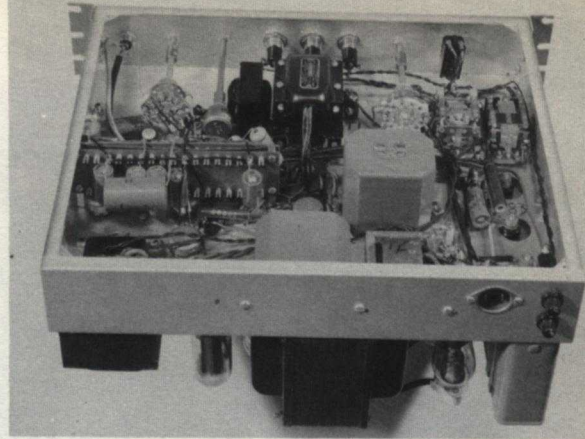

WELL-PACKED main chassis of the double sideband transmitter. Most small parts in the audio section were mounted on the two terminal boards shown back-to-back at the left side of the chassis in this view. The power input connector (J_3) and the fuse holders (F_1 and F_2) are on the rear apron of the chassis.

power input connector (J_3), but some distance from the time delay—grid current interlock tube (V_6).

The panel controls and indicator lamps line up vertically with the control shafts on the r.f. unit—spaced 2 inches—as shown in the front view on page 3 of the May-June, 1959 issue.

Grid and plate leads in the first few stages in the audio amplifier (V_7 , V_8 , V_9 and V_{10}) should be kept as short as possible to minimize hum pickup and the possibility of feed-back troubles. Medium voltage power and control circuits were wired with regular hookup wire; high voltage leads should be wire tested for several thousand volts. Pairs of wires carrying an alternating current should be twisted wherever possible.

TOP VIEW of the main chassis with locations of the major parts indicated. The black jack near the front of the chassis is for high voltage to the r.f. unit. Three other jacks in front of the audio tubes are for metering circuit connections in positions 9 (r.f. output voltage), 10 (400-volt range) and 11 (2000-volt range) of the meter selector switch.

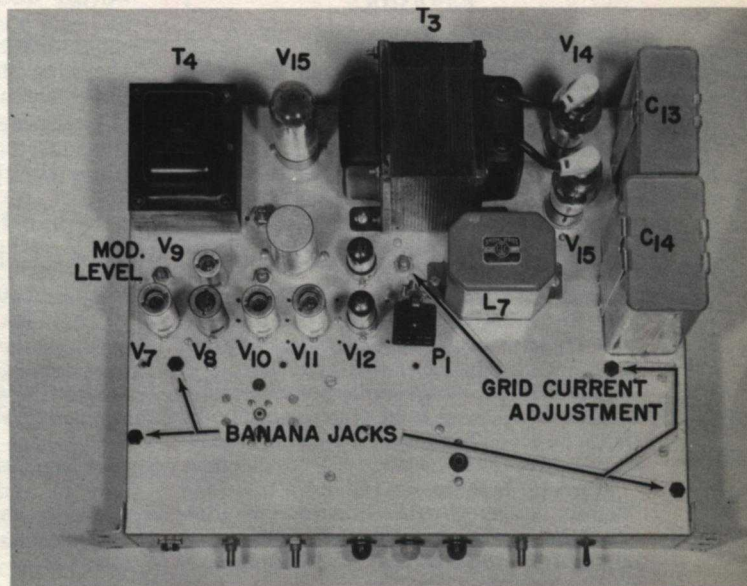

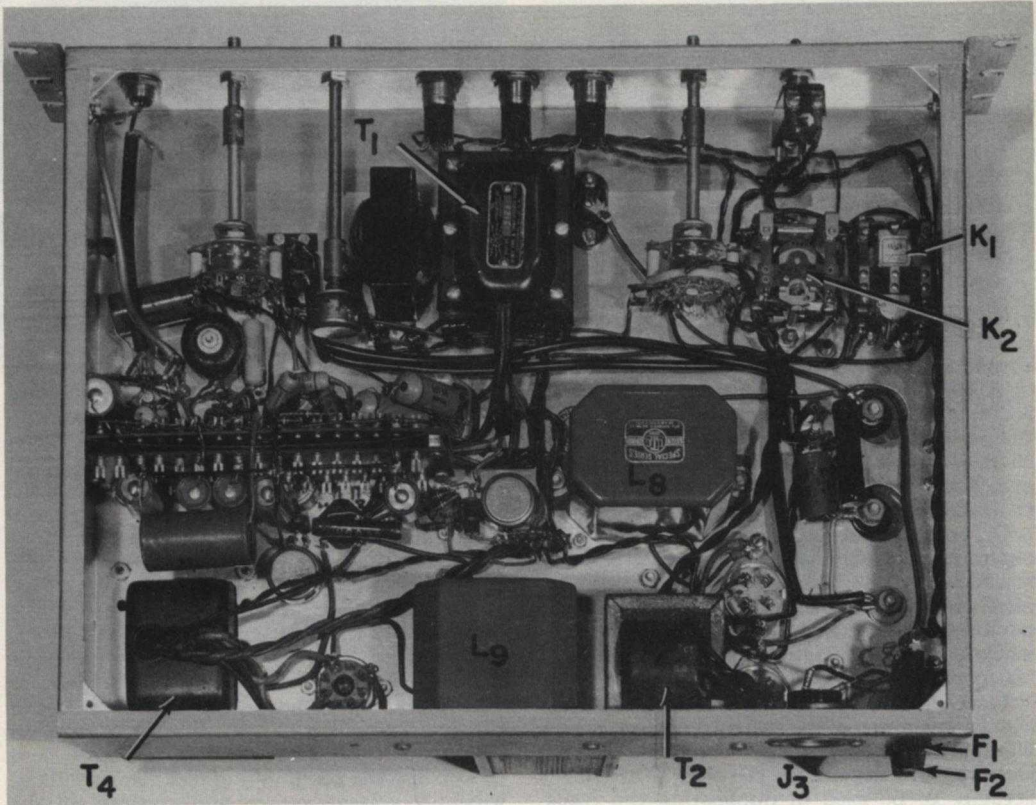

BOTTOM VIEW of the transmitter main chassis. Note the extension shafts on three of the panel controls. The doughnut-shaped coil just above the terminal boards is L_{10} , part of the audio low-pass filter. Wires carrying alternating current are twisted together wherever pos-

sible. Although the schematic diagram in the last issue showed all tube heaters operating from the 6.3-volt winding on T_4 , this model has a separate transformer for all the heaters in the r.f. unit, located just to the left of T_1 , and close to P_1 above the chassis.

PARASITICS

Several changes should be made in the schematic diagram, Fig. 1, on page 4 of the May-June, 1959 issue. They are:

- 1) Connect the cathode of V_{SA} (pin 3) to the cathode of V_{SB} (pin 8);
- 2) Cathode resistor for V_{10B} is 680 ohms;
- 3) Capacitor between the 150,000-ohm resistors in the grid circuit of V_{10B} is 0.001 mfd;
- 4) Resistor between 2700-ohm cathode resistor for V_{10A} and the 10,000-ohm potentiometer is 43,000 ohms;
- 5) RFC₆ in cathode of V_3 is 2.5 mh;
- 6) Resistor in cathode of V_5 is 39,000 ohms;
- 7) Resistor in plate voltage lead between L_9 and S_{1B} is 200,000 ohms;
- 8) Full scale current reading of meter with S_4 in position 3 should be 40 ma, not 50 ma. Or, for 50-ma full scale reading, change the 51-ohm resistor in the cathode of V_2 to 39 ohms.

A special bulletin, containing a corrected diagram, 11 x 17 inches in size, plus additional data on components, is available upon request from the *G-E HAM NEWS* office.

INITIAL ADJUSTMENT and tuneup, as outlined on pages 6 and 7 of the May-June, 1959 issue, should first be completed. Normal tuneup when operating the transmitter into a dummy, or "live" antenna, is quite simple.

First, set S_3 in the TUNE position and adjust C_3 and C_6 for maximum grid current in the 6146 stage, with the meter switch (S_4) in position 4 or 5. Then, turn S_3 to the TRANSMIT position, S_6 to the SINE WAVE position, and S_4 to position 9. Adjust the 500,000-ohm potentiometer in the grid of V_{10A} so that the meter (M_1) reaches about half scale when C_7 , C_9 and S_3 are adjusted for maximum meter reading.

Check the signal frequently, both with tone modulation, and with voice modulation, to ensure that the 6146 balanced modulator is operating properly without "flat-topping." For a discussion of the correct and incorrect scope patterns produced by a DSB transmitter, refer to "DSB Considerations and Data," *CQ* magazine, October, 1957, page 64. This article was written by Dale S. Harris, K3CBQ, of G-E's Heavy Military Electronics Department.

SOLID HIGH-C VFO

(Continued from page 4)

reached by setting C₁ at maximum, or minimum, capacity respectively, and adjusting L₁.

Warmup frequency drift of the 12-megacycle model oscillator was about 1 kilocycle in ten minutes, after which the oscillator remained within 100 cycles of the nominal frequency. This was without temperature compensating capacitors and thus could have been reduced appreciably.

A bulletin is available with a full size chassis layout drawing, also a schematic diagram of a mixer, crystal oscillator and amplifier unit which, when used with this oscillator, forms a heterodyne type exciter.

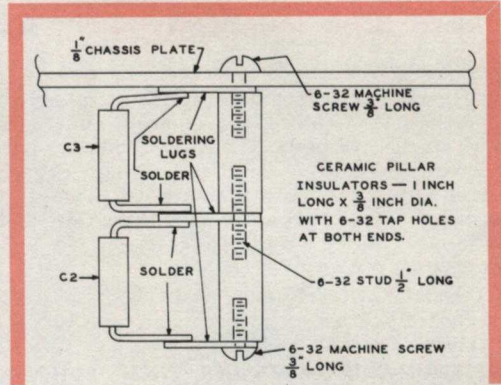

FIG. 3. ASSEMBLY DETAIL of the mounting for C₂ and C₃. Leads were clipped short and bent at right angles, close to capacitor body for rigidity. Threaded stud between pillars was made from 6-32 x 3/4-inch machine screw with head removed.

NOTE: The disclosure of any information or arrangements herein conveys no license under any patents of General Electric Company or others. In the absence of an express written agreement to the contrary, the General Electric Company assumes no liability for patent infringement (or any other liability) arising from the use of such information by others.

1959 Supplement to SPECIAL DX LOG ISSUE

(Cut out this log and paste it in the address space at the bottom of page 12 in the July-August, 1958 SPECIAL DX LOG ISSUE of G-E HAM NEWS; Vol. 13 No. 4.)

OFFICIAL COUNTRIES

Prefix	Country	Continent	Station Worked	Date	Band	A1 A3	QSL	
							Sent	Rec'd
CEφ ¹	Juan Fernandez Archipelago.....	S. America.....						
KS4 ¹	Roncador Cay & Serrana Bank Is... ..	N. America.....						
ZK1 ²	Manihiki (Northern Cook) Is.....	Oceania.....						
7G ³	Republic of Guinea (French West Africa).....	Africa.....						

FOOTNOTES

- ¹ New addition to ARRL Official Countries List since July 15, 1958, for creditable confirmations dated on or after November 15, 1945.
- ² Manihiki Islands counted as part of Cook Islands prior to March 1, 1959.
- ³ Republic of Guinea counted as part of French West Africa prior to October 1, 1958.

OTHER CHANGES IN DX LOG OF JULY-AUGUST, 1958

- Listing on page 4 for HKφ, Archipelago of San Andres and Providencia, shown in the Continent column as "S. America," should be changed to read "N. America."
- Listing on page 5 for PYφ, shown in the Country column as "Trindade," should read "Trindade and Vaz Islands."
- Listing on page 6 for UD6, Azerbaijan; UF6, Georgia; and UG6, Armenia, shown in the Continent column as "Asia," should be counted as "Europe" for the I.A.R.U.'s "Worked All Continents (WAC)" award. However, for the "Worked All Europe (WAE)" and similar awards in which European countries are involved, these three countries are considered as "Asia."
- Listing on page 7 for VS2, Malaya, should be changed in the Prefix column to read "9M2." Prefix for Malaya was changed to 9M2, effective January 1, 1959.
- Listing on page 8 for ZC3, Christmas Island, should be changed in the Prefix column to read "VK9."
- Listing on page 9 for Nepal, shown in the Prefix column with no regular assigned prefix, should be changed to read "9N."

TECHNICAL INFORMATION—6EZ8

Triple, high- μ miniature Triode

The industry's first triple triode receiving tube—the 6EZ8—is capable of serving as a one-tube tuner at frequencies as high as the FM band. This 9-pin miniature packs three complete triodes in one envelope, saving designers the cost of extra tubes in many applications. Two sections have a common cathode connection, while the third section's cathode is brought out to a separate pin.

ELECTRICAL DATA

Cathode—Coated Unipotential

Heater Voltage	6.3 \pm 10%	Volts
Heater Current	0.45	Amperes

DESIGN-MAXIMUM VALUES, EACH SECTION

Plate Voltage	330	Volts
Positive DC Grid Voltage	0	Volts
Negative DC Grid Voltage	50	Volts
Plate Dissipation, Each Plate	2.0	Watts
Total Plate Dissipation, All Plates	5.0	Watts
Heater-Cathode Voltage (Section 3)		
Plus or Minus	100	Volts

AVERAGE CHARACTERISTICS, EACH SECTION

Plate Voltage	125	Volts
Grid Voltage	-1.0	Volts
Amplification Factor	57	
Plate Resistance, approximate	13600	Ohms
Transconductance	4200	Micromhos
Plate Current	4.2	Milliamperes
Grid Voltage, approximate $I_b = 20$		
Microamperes	-4	Volts

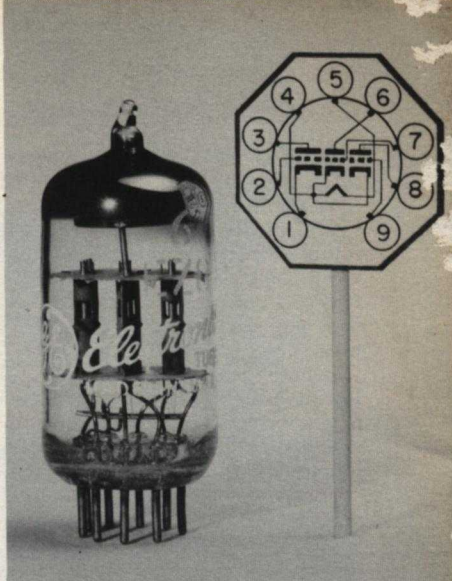

TERMINAL CONNECTIONS

EIA 9KA

Pin 1	Cathode (Section 3)
Pin 2	Grid (Section 3)
Pin 3	Plate (Section 3)
Pin 4	Cathode (Section 2), Cathode (Section 1), and Heater
Pin 5	Heater
Pin 6	Plate (Section 2)
Pin 7	Grid (Section 2)
Pin 8	Plate (Section 1)
Pin 9	Grid (Section 1)



HAM NEWS

JULY-AUGUST, 1959

VOL. 14—NO. 4

Available **FREE** from your
G-E Tube Distributor

E. A. Neal, W4ITC—Editor

BUILD-IT-YOURSELF IDEAS

from the 999 radio amateurs at

GENERAL  ELECTRIC

published bi-monthly by

RECEIVING TUBE DEPARTMENT

Owensboro, Ky.

If You Didn't Get This From My Site,
Then It Was Stolen From...

www.SteamPoweredRadio.Com