



**Electronic
TUBES**

G-E HAM NEWS

Copyright 1958 by General Electric Company

GENERAL ELECTRIC

MAY-JUNE, 1958

VOL. 13—NO. 3

If You Didn't Get This From My Site,
Then It Was Stolen From...
www.SteamPoweredRadio.Com

PACKAGED VHF EXCITERS

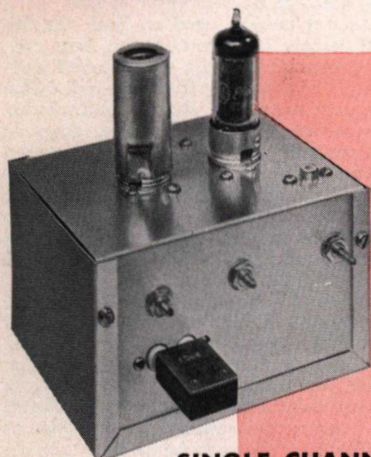

SINGLE CHANNEL

28 OR 50 MEGACYCLES, 3 WATTS

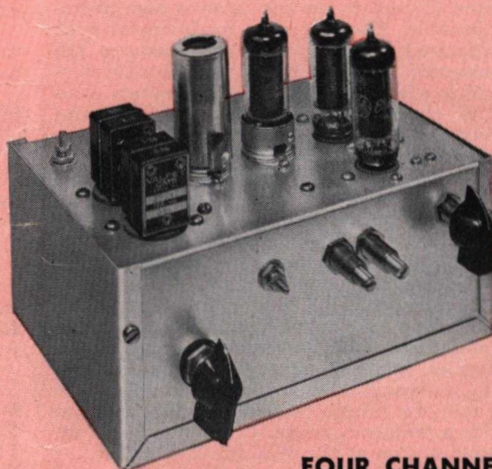

FOUR CHANNELS

144 MEGACYCLES, 6 WATTS

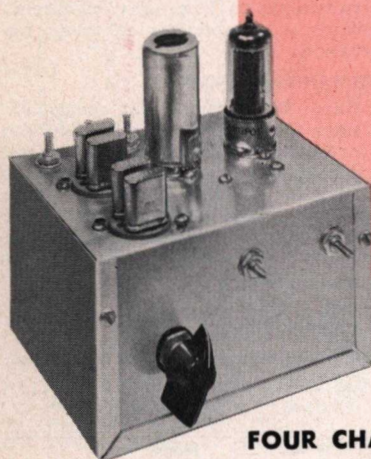

FOUR CHANNELS

28 OR 50 MEGACYCLES, 3 WATTS

The old saying, "Good things come in small packages," was the watchword in designing these simple, compact exciters for 28-, 50- and 144-megacycle amateur transmitters. Try the circuits—and unitized construction ideas—in your next transmitter for one or more of these bands.

—*Lighthouse Larry*

CONTENTS

Packaged VHF Exciters	page 2
Sweeping the Spectrum	page 7
VHF Exciter/K2DBS	page 8

PACKAGED VHF EXCITERS

It's smart to build new equipment for your amateur station in small units for improved flexibility, shielding and ease of making modifications. This concept is demonstrated in packaged exciter units for transmitters operating in the 28-, 50- and 144-megacycle amateur bands. The 28- and 50-megacycle exciters will deliver about 3 watts, and the 144-megacycle exciter about 6 watts of power output. This power is sufficient to drive most pentode Class C power amplifiers in the 100-watt power class; or, for certain amplifier tubes capable of handling several hundred watts input.

CIRCUIT DETAILS

The basic single channel exciter unit for the 28- and 50-megacycle bands, as shown in the main schematic diagram, Fig. 1, has three stages, but only two tubes. All stages are biased for Class C operation. The triode section of a 6U8 triode-pentode is an oscillator for crystals in the 6- to 9-megacycle frequency range. **TABLE I** lists the choice of crystal frequencies for each band, and the frequencies to which the resonant circuits in each stage are tuned for output on the 28-, 50- and 144-megacycle bands.

There may be a few eyebrows raised over our selection of a fundamental frequency type crystal oscillator instead of an overtone circuit, especially since the recent trend has been to operate the oscillator as high in frequency as possible. However, the fundamental type oscillator, operated at low power level, assures the excellent frequency stability necessary for double sideband and other suppressed carrier transmitters—and even for CW operation without the “chirps” and “yoops” which readily identify so many VHF transmitters using overtone type oscillator circuits.

Some amateurs may prefer the convenience of a multi-channel type oscillator, rather than having to plug in a different crystal each time a shift in operating frequency is made. The four-channel oscillator circuit, shown in Fig. 2, permits the use of any combination of crystals for a specific band, as listed in **TABLE I**, with a separate plate circuit coil, L_{1A} to L_{1D} , for each crystal.

If all crystals for a specific band are within a fraction of a megacycle of each other in frequency—say 8.334 to 9.000 megacycles, for a 50-megacycle exciter—only a single coil, L_1 , is required. It is possible to adjust the tuning slug in L_1 for proper operation of the oscillator over this wide a frequency range.

The pentode section of the 6U8 amplifies either the second, third or fourth harmonic of the oscillator frequency, depending on the crystal frequency, and band upon which output is required. The third stage, a 6CL6 pentode, always operates as a frequency doubler. The RF output from the 6CL6 stage is coupled to a coaxial

cable with a 3-turn link coil, L_4 , wound around the “cold” end of L_3 .

Coil L_2 tunes to 24—27 megacycles, and L_3 to 48—54 megacycles, with only the tube and stray capacitances across each. To adapt these tuned circuits for operation on the 28-megacycle band, simply add the additional capacitances C_2 and C_3 across L_2 and L_3 , shown in dotted lines on the schematic diagram.

To obtain output on the 144-megacycle band, a fourth stage—a push-pull frequency tripler with a pair of 6CL6's—is added to the exciter. As shown in the tripler schematic diagram, Fig. 3, this stage is driven by closely coupling the grid coil, L_5 , to L_3 in the 6CL6 doubler stage; the two circuits thus form a bandpass coupler covering the 48—49.3-megacycle range. The plate tank circuit, L_6 — C_5 , is tuned to the 144-megacycle band. Output from this stage is obtained from a 2-turn link coil, L_7 , inserted at the center of L_6 .

The four-stage exciter can be used on both the 50- and 144-megacycle bands by winding the link coil, L_4 , around L_3 and connecting it to a separate RF output jack. Some means of disabling the push-pull 6CL6 stage for 50-megacycle operation should be included in the external power circuitry. The tuning slugs in coils L_1 , L_2 , and L_3 probably will have to be readjusted when changing from 50- to 144-megacycle output.

A suggested circuit by which the heater and plate power may be switched between two exciters is shown in the schematic diagram of Fig. 4. If desired, a third switch position on S_2 , and third power socket, can be added to accommodate a third exciter.

Metering of the control grid currents in the second, third and fourth stages of the exciters is accomplished by measuring the voltage drop across a portion of the grid bias resistance in each stage. Suggested values for the metering circuit resistors— R_1 , R_2 , R_3 and R_4 in the various schematic diagrams—have been tabulated in **TABLE II**. Select the proper resistors for the type of multimeter, or milliammeter, that will be used to tune up the exciter. Some values listed are not exact for a specific full-scale current reading; they have been rounded off to the nearest value for 10 percent tolerance resistors.

The screen voltage connections to all tubes have been brought out to a separate pin on J_1 , so that this circuit can be keyed (through a suitable keying relay, for safety) for CW operation.

MECHANICAL DETAILS

Miniboxes were found to be convenient chassis for the VHF exciters, since they provide nearly complete shielding and easy access to the under-chassis corners. The 4 x 5 x 3-inch size *Minibox* has adequate space for the three-stage exciters for the 28- and 50-megacycle bands. All components were mounted on the half of the *Minibox* which forms an open-end chassis, as shown in the drilling diagram, Fig. 5.

(Continued on page 5)

TABLE I—OPERATING FREQUENCY CHART

OUTPUT BAND MC.	CRYSTAL AND L_1 — C_1	2ND STAGE L_2 — C_2	3RD STAGE L_3 — C_3 (L_5 — C_4 144 MC.)	4TH STAGE L_6 — C_5 (144 MC. ONLY)
28 MC.	7.000—7.425 MC.	14.0—14.850 MC. (doubler)	28.0—29.70 MC. (doubler)	None
50 MC.	6.25—6.75 MC.	25.0—27.0 MC. (quadrupler)	50.0—54.0 MC. (doubler)	None
50 MC.	8.334—9.0 MC.	25.0—27.0 MC. (tripler)	50.0—54.0 MC. (doubler)	None
144 MC.	6.000—6.166 MC.	24.0—24.666 MC. (quadrupler)	48.0—49.333 MC. (doubler)	144.0—144.8 MC. (tripler)
144 MC.	8.000—8.222 MC.	24.0—24.666 MC. (tripler)	48.0—49.333 MC. (doubler)	144.0—144.8 MC. (tripler)

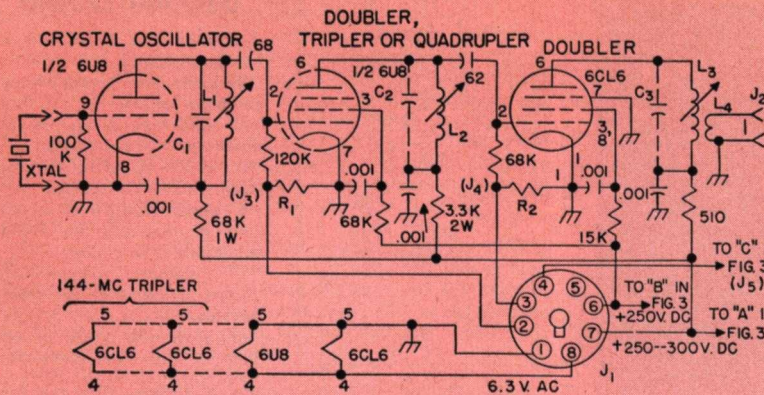

Fig. 1. Basic schematic diagram for the packaged VHF exciters. All capacitance values given in whole numbers are mica, 500 volts working. Capacitance values given in decimals are disc ceramic, 500 volts working. Resistances are 1/2-watt, plus or minus 10-percent tolerance, unless otherwise specified. Separate phone tip jacks for metering grid currents (J_3 , J_4 and J_5) can be installed on the chassis, instead of running the leads connected to pins 2, 3 and 4 on J_1 to the external metering circuit, shown in the diagram of Fig. 4.

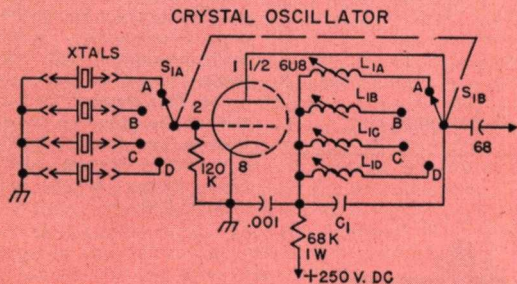

Fig. 2. Schematic diagram for the optional four-channel crystal oscillator circuit. Coils L_{1A} to L_{1D} are the same as L_1 .

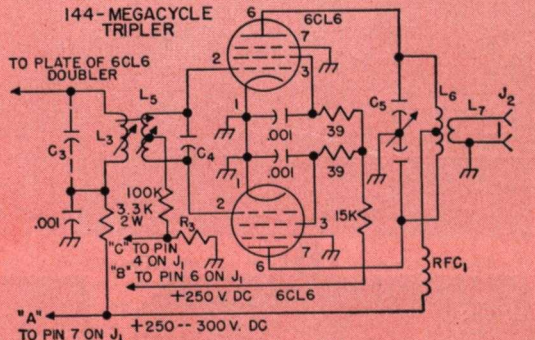

Fig. 3. Schematic diagram of the push-pull tripler circuit for the 144-megacycle band. The power metering and RF driving circuits connect to those in the basic schematic diagram Fig. 1.

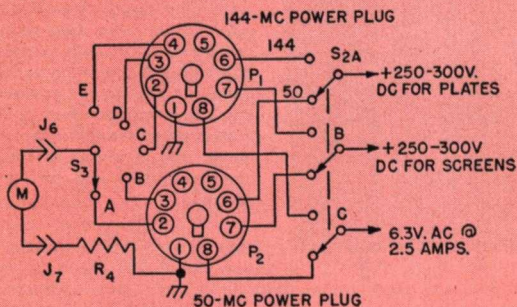

Fig. 4. Suggested power connection and switching and metering circuits for use with two packaged exciters. Additional power connectors can be added to the circuit as required.

TABLE II—METERING RESISTORS

Range & Resistance	(0—1 ma.) R_1 & R_2	(0—5 ma.) R_3	R_4
Meter Only			
0—1 ma.	1,000	12	0
0—0.2 ma.	62	10	0
0—0.05 ma.	56	10	0
0—5 volts (5,000 ohms/v.)	6,200	1,000	24,000
0—5 volts (20,000 ohms/v.)	5,100	1,000	91,000

PARTS LIST

- C_1 62 mmf NPO ceramic, or mica, 500 volts
- C_2 47 mmf NPO ceramic, or mica, 500 volts (See Text)
- C_3 39 mmf NPO ceramic, or mica, 500 volts (See Text)
- C_4 6.8 mmf NPO ceramic, 500 volts
- C_5 2.7—10.8 mmf per section, butterfly variable capacitor
- J_1 Male octal plug with chassis mounting plate (Amphenol 86-PM-8 and 78-RS plate)
- J_2 Midget chassis type phono jack
- J_3 to J_6 Insulated phone tip jack
- J_7 Non-insulated phone tip jack
- L_1 to L_7 Coils, see COIL TABLE
- M Meter see TABLE II
- R_1 to R_4 Meter shunt resistors, see TABLE II
- RFC $_1$ 1.8 uh RF choke (Ohmite Z-144)
- S_1 Two-pole, four-position ceramic tap switch (Centralab No. PA-2003 six-position switch set for four positions)
- S_2 Three-pole, two-position tap switch (three positions if three exciters are used)
- S_3 One-pole, five-position tap switch

COIL TABLE

- L_1 , L_2 , L_3 , and L_5 are wound on 3/8 of an inch diameter iron slug-tuned coil forms, 1 1/8 inches long (Cambridge Thermionic Corp. type CTC-LS-3)
- L_1 4.2—8.7 uh coil, 30 turns of No. 30 enameled wire closewound 3/8 of an inch long; or, CTC type LS-3 5-MC wound coil.
- L_2 1.4—2.0 uh, 18 turns, No. 22 enameled wire closewound 1/2 of an inch long
- L_3 0.4—0.6 uh, 11 turns, No. 22 enameled wire spacewound 1/2 of an inch long
- L_4 3 turns, No. 16 tinned or insulated wire, 1/2 of an inch in diameter, wound over by-passed end of L_3
- L_5 Same as L_3 , except with tap at center
- L_6 0.12 uh, 4 turns, No. 14 tinned wire, 5/8 of an inch in diameter, 1 3/8 inches long, 4 turns per inch with a 3/8 of an inch space in center for L_7
- L_7 2 turns, No. 14 tinned wire, 3/8 of an inch in diameter, 1/8 of an inch spacing between turns inserted at center of L_6

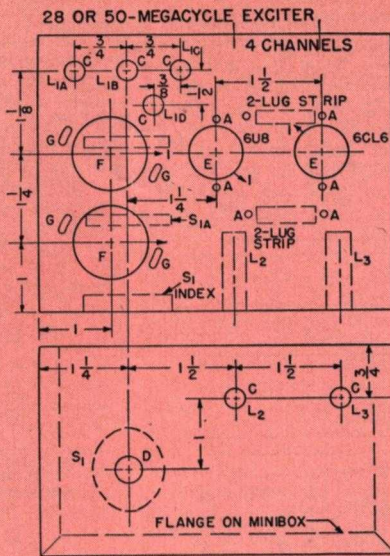
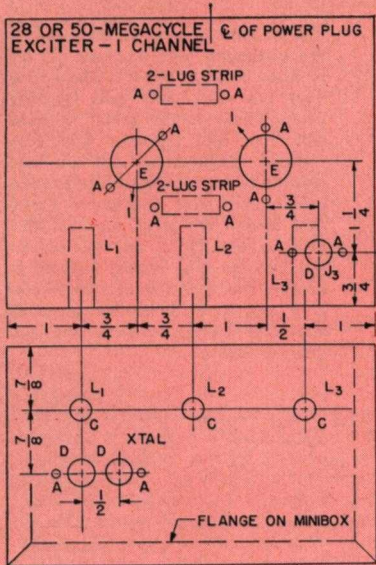

DRILLING LEGEND

"A" drill—No. 32 for No. 4 machine screws.
 "B" drill—No. 26 for No. 6 machine screws.
 "C" drill— $\frac{3}{32}$ of an inch in diameter for coil forms.
 "D" drill— $\frac{3}{8}$ of an inch in diameter for S₁ and J₂.
 "E" socket punch— $\frac{3}{4}$ of an inch in diameter for 9-pin miniature tube sockets.
 "F" socket punch— $1\frac{1}{8}$ inches in diameter for octal sockets.
 "G" slots— $\frac{1}{8}$ x $\frac{1}{4}$ of an inch in size for hardware.

Fig. 5. Drilling diagrams for the 4 x 5 x 3-inch Miniboxes in which exciters for the 28- and 50-megacycle bands were assembled: Left—the single channel exciter; right—the four-channel exciter. Any of the following boxes may be used: Bud CU-3005; ICA 29340; Premier AMC-1005; Wyco E-923; and LMB TF-779.

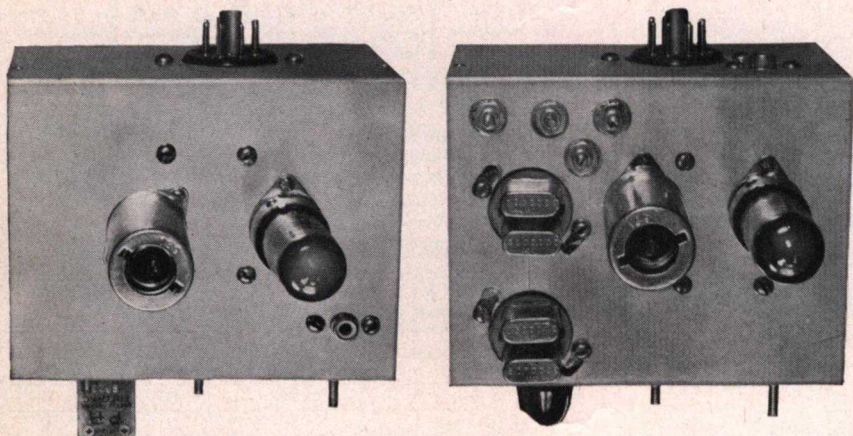
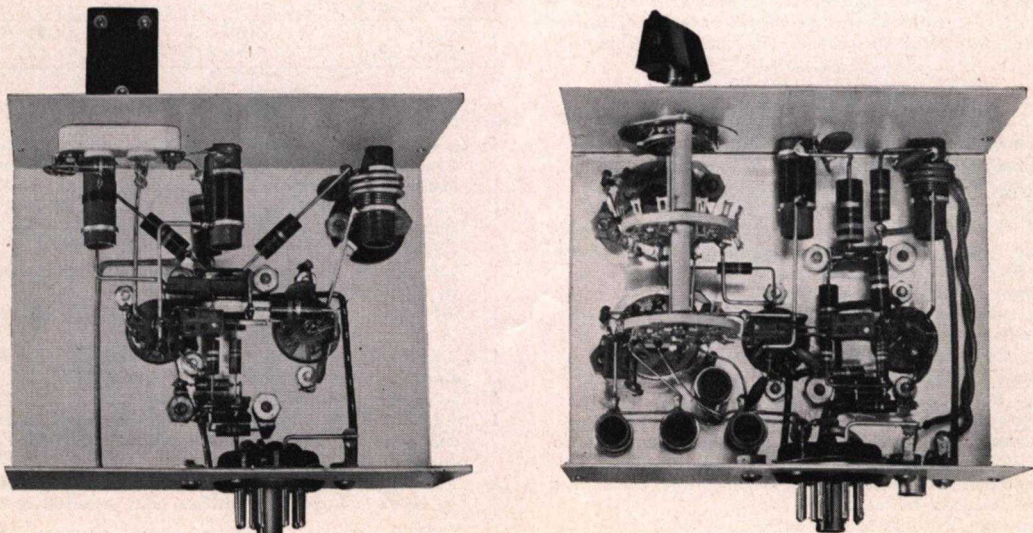

Fig. 6. Top and bottom view photographs of the exciters for 28 and 50 megacycles. Left—the single channel exciter. Right—the four-channel exciter. On both models the $1\frac{1}{2}$ -inch diameter socket hole for the power connector, J₁, was punched 1½ inches down from the chassis deck; and 3 inches in from the oscillator end of the chassis.



(Continued from page 2)

A similar parts layout was followed for both the single- and four-channel exciters; the principal difference being that the tube socket locations were shifted slightly on the four-channel exciter to allow more room for the crystal sockets and oscillator plate circuit coils, L_{1A} to L_{1D} . Comparison of the top and bottom view photographs of the exciters, Fig. 6, will show that the four-channel exciter appears more complex than it actually is, largely due to the use of a two-wafer tap switch for S_1 .

Slots were provided for the machine screws which fasten the octal sockets for the crystals in place; this allows the sockets to be oriented so that the crystal holders run parallel with the chassis. The octal sockets will accommodate crystal holders having 0.094-inch diameter pins spaced 0.486 of an inch. Four special crystal sockets may be substituted, particularly if crystal holders having 0.050-inch diameter pins will be employed, by drilling the chassis differently.

The RF output connector, J_2 , was mounted on the chassis deck, above L_3 , in the single channel exciter. This permitted the link coil, L_4 , to be suspended from the lugs on J_2 . In the four-channel exciter, J_2 was located on the rear of the chassis. A single length of insulated hookup wire was wound around L_3 to form L_4 , and the excess wire was twisted and run back to J_2 . The power connector, J_1 , also mounts on the rear of the chassis in the location shown in the bottom view.

A larger *Minibox*, 5 x 7 x 3 inches in size, provides the additional space required for the push-pull 6CL6 tripler stage in the 144-megacycle exciter model. The parts layout for the first three stages, as shown in the drilling diagram for the four-stage exciter, Fig 7, is essentially similar to the four-channel, three-stage exciter previously described. The bottom view photograph shows that somewhat more space is available for the oscillator plate coils on the 5-inch-wide chassis. In this model, a single wafer tap switch was used for S_1 .

Sockets for the 6CL6 tubes and other components in the tripler stage have been positioned to permit very short connections. The coils in the bandpass coupler, L_3 and L_5 , were mounted on a small angle bracket, marked "A," instead of being fastened to the front wall of the chassis. Another angle bracket, marked "B," supports the plate tuning capacitor, C_5 . The dimensions and drilling details for both brackets are shown in Fig. 8.

Shafts which extend these three tuning adjustments out through the front panel were made from 1/4-inch diameter brass rod. Drill and tap a hole for a 6-32 machine screw in one end of the 1 1/2-inch long shafts for L_3 and L_5 , and saw a slot for a screwdriver in the other end. After the coils have been mounted, first assemble a 6-32 hex nut on the slug screws, then run the extension shaft onto this screw about six turns and tighten the lock nut against the end of the shaft. The shaft may be run through a 1/4-inch diameter hole in the chassis, or through a panel bearing, as illustrated.

Since C_5 has a 1/8-inch diameter shaft, a special extension shaft was made by drilling a 1/8-inch diameter hole through a 1/2-inch length of brass rod 3/8 of an inch in diameter. Then, about one-half of the hole is enlarged to 1/4 of an inch in diameter, and a 1 1/4-inch length of 1/4-inch diameter brass rod is soldered into it. Finally, a small hole is drilled and tapped for a set screw, as shown in the bottom view. This extension shaft should be inserted through the 1/4-inch diameter hole in the chassis, or panel bearing, before C_5 and its mounting bracket is assembled.

The tie points which support the resistors and other small parts are located in the positions indicated on the drilling diagram for each exciter. Most resistors are soldered directly between the lugs on components to which they are connected. All disc ceramic by-pass capacitors should be fastened in place with the shortest possible leads; those which bypass the screen grids of tubes in the second, third and fourth stages should be

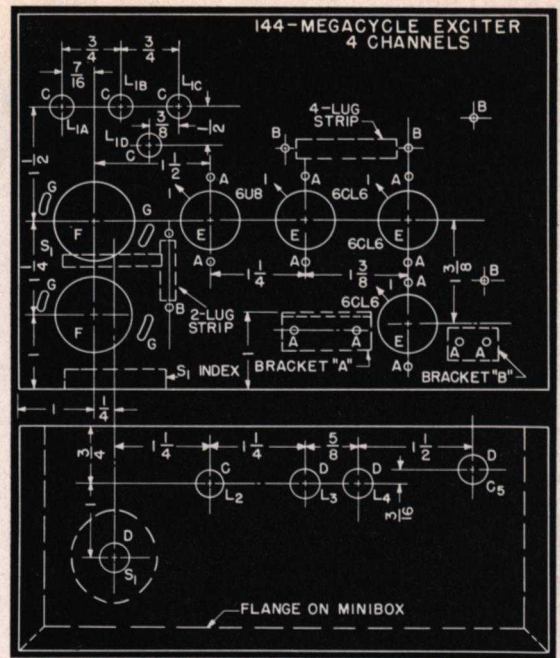

Fig. 7. Drilling diagram for the 5 x 7 x 3-inch *Minibox* in which the four-channel exciter for the 144-megacycle band was constructed. Brackets "A" and "B" are located in the positions shown with the vertical portions of both brackets away from the chassis front wall. Suitable chassis boxes are: Bud CU-3008; ICA 29343; Premier AMC-1008; Wyc0 E-926; and LMB TF-782.

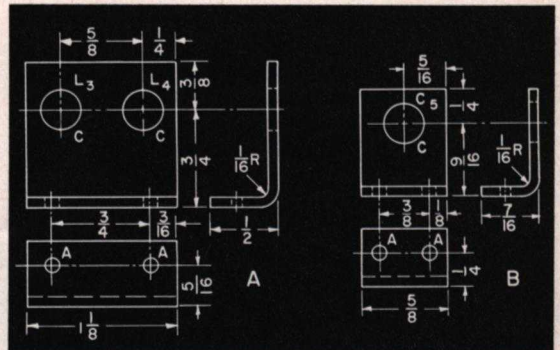

Fig. 8. Detail drawings for fabricating the angle brackets used to mount the following components in the 144-megacycle exciter: "A"—coils L_3 and L_5 ; and "B"—capacitor C_5 . Holes on the main chassis should be marked for location from these brackets.

connected between the screen grid and cathode lugs on the tube sockets. All grid and plate leads are No. 16 tinned copper wire, also as short as possible. Power leads are insulated No. 20 stranded hookup wire, run close to the chassis wherever possible to reduce RF pickup. Most other constructional details should be apparent after studying the illustrations.

OPERATION

To make the tune-up procedure more meaningful, we'll assume that a four-channel, 50-megacycle exciter is being adjusted for broadband operation between 50 and 51 megacycles (crystal frequencies between 8.334 and 8.500 megacycles). Two crystals, one each at ap-

proximately 8.375 and 8.450 megacycles (exciter output frequencies of 50.25 and 50.7 megacycles, respectively) should be plugged into positions "A" and "B" in the crystal sockets.

After the usual final wiring check, plug in the 6U8 oscillator tube and apply heater power. If the tube heater lights properly, plug a 0—1 millimeter into the metering tip jacks, J_1 and J_7 . Turn the crystal switch, S_1 , to position "A" (6.375-megacycle crystal); the meter switch, S_2 , to position "A"; and apply plate voltage to the exciter. Turn the tuning slug in L_{1A} through its adjustment range. When the oscillator starts running, about 0.3 milliamperes of grid current in the second stage should be measured on a 0—1 millimeter. Adjust the slug so that the oscillator starts immediately each time plate voltage is applied.

Next, plug in the 6CL6 doubler tube, turn S_1 to position "B" (8.450-megacycle crystal), set S_3 on position "B," and tune the slug in L_2 for maximum grid current—about 1.5 milliamperes—in the 6CL6 stage. Connect a suitable dummy load to J_2 , reset S_1 to position "A," and tune the slug in L_3 for maximum output. A No. 40 or 47 pilot lamp, soldered with short leads to a midjet phono plug, is a handy dummy load for test purposes. The pilot lamp should light to full brilliancy if the exciter is delivering adequate power output.

The exciter should now be capable of delivering nearly constant power output over the range of 50 to 51 megacycles. Finally, adjust the slugs in L_{1C} and L_{1D} for maximum grid current with S_3 in position "A," with crystals plugged into the remaining two crystal sockets.

When the 50-megacycle exciter is coupled to the grid circuit of a succeeding Class C power amplifier stage through a short length of coaxial cable plugged into J_2 , the tuning of L_3 should again be checked so that maximum grid current is read in the power amplifier at 50.25 megacycles. If the amplifier grid tank circuit is tuned for maximum grid current with the exciter driving it at 50.5 megacycles, little variation in grid current should be measured over the 50- to 51-megacycle range.

When tuning up the 144-megacycle exciter, switch position "C" on S_3 is used to meter the grid current in the second stage when adjusting the oscillator coil, L_1 ; position "D" reads the 6CL6 doubler grid current; and position "E" meters the grid current in the push-

pull 6CL6 tripler stage. The procedure outlined for tuning L_1 and L_2 in the 50-megacycle exciter is again followed; then the meter is switched to position "E" and L_3 is tuned for maximum grid current at a frequency of 48.3 megacycles (crystal, 8.05 megacycles). The grid coil, L_5 is tuned for maximum grid current at a frequency of 48.9 megacycles (crystal, 8.15 megacycles). This should result in little variation in grid current in the tripler stage over the range of 48.0 to 49.3 megacycles.

The tripler plate circuit tuning capacitor, C_5 may be tuned to 144.5 megacycles if most operating will take place in the 144- to 145-megacycle range. However, if the entire power output of the exciter is required to drive a succeeding power amplifier, C_5 probably will have to be retuned each time a shift in operating frequency greater than 200 kilocycles is made.

Any of the popular twin pentode power tubes designed for operation in the VHF spectrum—815, 829B, 5894—or a pair of 6146's—in push-pull circuits, make an excellent power amplifier to follow these exciters. Circuits and construction ideas for amplifiers using these tubes may be found in the list published below.

829B and 5894:

1. "144-megacycle Double Beam-tetrode Power Amplifier," *QST*, March, 1946, page 55; or, *ARRL Handbook*, VHF Transmitters chapter, 1948 to 1952 editions.
2. "A 100-watt RF Amplifier for 50 and 144 Megacycles," *ARRL Handbook*, VHF Transmitters chapter, 1953 and 1954 editions.
3. "A 6- and 2-meter 829B FM-AM Transmitter," *CQ*, May, 1949, page 28.
4. "829B Transmitter for 10 and 6 Meters," *Radio Handbook*—Twelfth Edition, Low Power Transmitters chapter, page 71.

815:

1. "A 60-watt Transmitter for 50, 28 and 144 Megacycles," *ARRL Handbook*, 1948 to 1951 editions.

6146:

1. "Step-by-step Transmitter for the VHF Man—Part II," *QST*, November, 1954, page 41; or, *ARRL Handbook*, VHF Transmitters chapter, 1955 to 1958 editions.

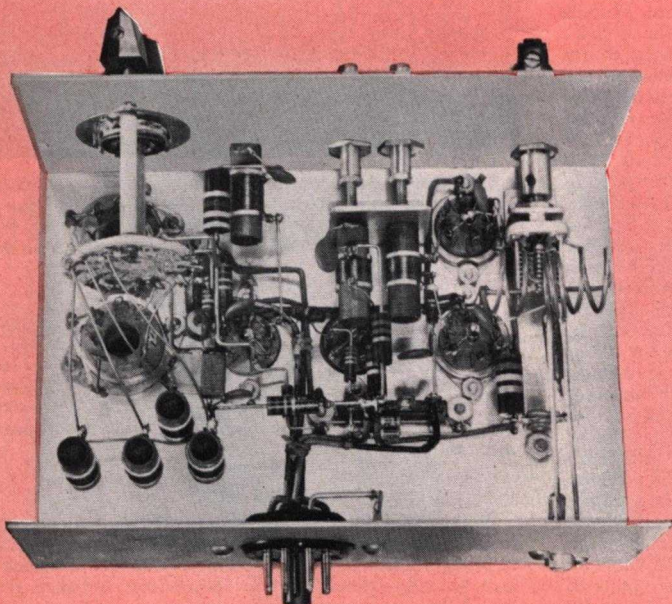
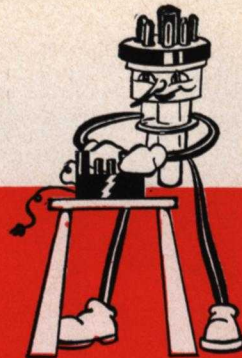

Fig. 9. Bottom view photograph of the 144-megacycle exciter. The crystal switch, in this model, S_1 , was assembled from a Centralab PA-300 miniature rotary switch index assembly; and a PA-3 two-pole, 6-position ceramic tap switch section. One $\frac{1}{8}$ -inch and one $\frac{3}{8}$ -inch long spacer was assembled on each threaded rod between the switch wafer and the index plate. The output link coil, L_7 , is wound with 3-inch leads spaced about $\frac{1}{4}$ of an inch, for the connections to J_2 . Instructions for making and assembling the extension shafts on L_5 , L_3 and C_5 are given in the text under MECHANICAL DETAILS. The power connector, J_1 , was located in the same position as described for the three-stage exciters, Fig. 6.

SWEEPING *the* SPECTRUM



MEET THE DESIGNER—K2DBS, William F. Kail, a sales engineer with G.E.'s Communication Products Department, has pointed the way toward improving the frequency stability of VHF transmitters with his **PACKAGED VHF EXCITERS**, described elsewhere in this issue of *G-E HAM NEWS*. The oscillator and frequency multiplier circuits, similar to those found in G.E.'s fine *Progress Line* of two-way mobile radio equipment, meet the stringent frequency stability and driving power requirements of Bill's high-level double sideband balanced modulators for the VHF bands.

Two other call letters, W3UQK and W8OQT, have been held by K2DBS since his amateur radio career started in 1951. Bill now resides in North Syracuse, New York, near G.E.'s Electronics Park plant. As you may have surmised, Bill is among that growing multitude of hams whose main interest is the furtherance of communications on the VHF amateur bands.



The flood of replies to my **READER SURVEY** (See *G-E HAM NEWS*, MARCH-APRIL, 1958, Vol. 13, No. 2; page 7) is just being tabulated, but a quick check indicates that a clear majority of radio amateurs want more information on single sideband, double sideband and simple, but efficient, equipment for the VHF bands.

There also have been many requests for information on simple test equipment for the ham shack, plus instructions for calibrating it. Many of you want information on making simplified tests and measurements on transmitters, receivers and antennas.

I certainly appreciate the interest of those persons who have returned the survey coupon. If you haven't seen that issue, pick up a copy from your nearest G-E tube distributor; or, send a postal card to me, requesting it. Of course, it isn't necessary to use the survey coupon if you don't wish to cut it out of that issue; just write your answers on a postal card and send it to the following address: Lighthouse Larry, General Electric Company, Electronic Components Division, Building 267-2, Schenectady, N. Y., U.S.A.



Here's good news for all radio club television interference (TVI) committees (or for anyone with TVI problems) who never did garner a copy of the book *Television Interference* originally published by Philip S. Rand, W1DBM. A new and up-to-date book, *Television Interference, Its Causes and Cures*, has now been made available by the Nelson Publishing Company of Redding Ridge, Connecticut. This is a *Television Interference Handbook*—not a collection of reprinted magazine articles.

The new book may be ordered directly from that firm, or through the Radio Society of Great Britain. It also is available from numerous electronic parts distributors in the United States and Canada. The price is a nominal \$1.75 in the United States; \$2.00 elsewhere.

Just about every conceivable TVI situation is covered, including chapters on the sources, types and

means of locating TVI; shielding and filtering; special VHF problems; design and use of filters; generation of harmonics in external devices (oxidized joints between metal objects), industrial, medical and public utility TVI; bibliography of magazine articles on TVI; list of TVI committees; and finally, excerpts from the FCC rules concerning TVI. Need I say more?

And while we're speaking of W1DBM, many of you will recall that he received a special citation plaque from the judges of G.E.'s annual Edison Radio Amateur Award program for his outstanding research and contributions to the solution of TVI problems, both in the amateur radio and industrial fields.



My **LOG FORM QSL** card has just blossomed out in a new three-color combination! No—we didn't call in a color stylist to create it—the colors are the same as those on the latest G-E tube carton—orange-red, grey and black.

There are now millions of these cards in circulation. You may have seen them in other colors—beige, blue or maroon—but we firmly believe that the new three-color card is the sharpest! If you'd like to examine a sample card—Form 73B—just write, "Sample QSL," and your name and address on a postal card—or one of your present QSL cards—and send it to me.

The cards are furnished without imprinting, packaged in quantities of 250, all ready to mail, postpaid, to those persons who send in a check or money order for \$1.00. Of course, if you need more cards (500, 750, 1000, or other multiples of 250), we'll ship a real big package of them to you at the same rate. And be sure to include your complete mailing address—we want to make sure that your cards arrive without delay.



We've received a great number of requests for an updated edition of the *G-E HAM NEWS DX LOG* issue since it was last revised (see *G-E HAM NEWS*, January-February, 1956; Vol. 11, No. 1). Altogether, four editions of this issue have been published.

A fifth revision is now in the works; and in it, the spacing between lines will be expanded to allow more room for large writing. Also, a couple countries will be placed on the correct continents; a special listing of outdated call-letter prefixes and countries no longer on the official list will be added; and, finally, the whole issue will be printed on less glossy paper for greater ease in writing.

You, the many users of our *DX LOG*, are best qualified to know what improvements, other than the above, should be included. If you let me know soon, giving your thoughts on any changes or additional features you will find handy, we'll have time to include as many features as possible.

And if you're anxious to know when this new *DX LOG* will be available, your local G-E tube distributor should have them early in August.

—Lighthouse Larry

VHF EXCITER/K2DBS

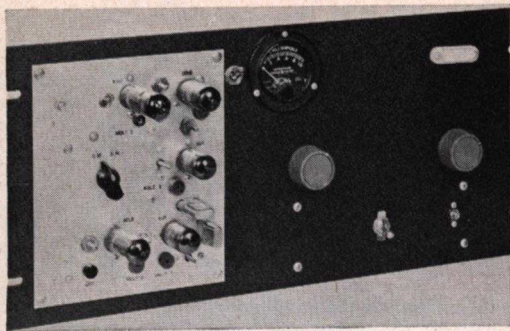

Looking for still other VHF exciter construction ideas? Here's how the designer of the packaged exciters, K2DBS, has combined two exciters on a single flat metal plate for his own VHF station. The view above (left) shows how the exciters and a Millen No. 90811 high frequency power amplifier unit, share an 8 3/4 x 19-inch relay rack panel.

Both exciters have single channel oscillator circuits: the three-stage exciter for 28 and 50 megacycles occupies the lower portion of the plate; and the 144-megacycle four-stage exciter runs up the right side, and across the top. A 6360 twin pentode tube was used in the 144-megacycle tripler, instead of the two 6CL6 tubes shown in Fig. 3.

The under-chassis view (right) shows the constructional details and principal differences between this exciter and the packaged exciters built in *Miniboxes* (Figs. 6 and 9): A barrier terminal strip for the power and 300-ohm twinlead RF output connections; rotary tap switch to transfer power from one exciter to the other (S₂ in Fig. 4); and insulated phone

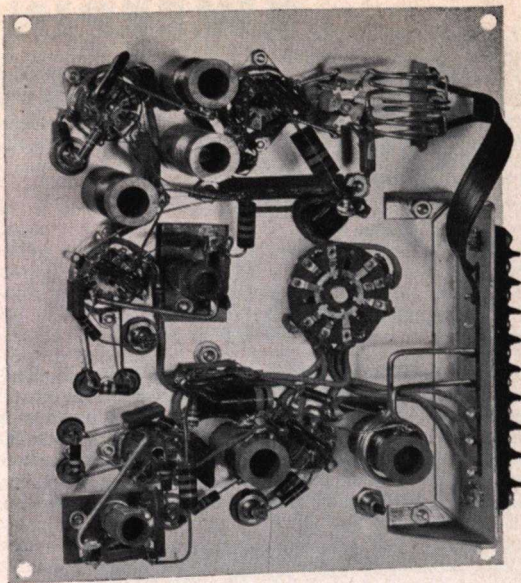

tip jacks (J₃, J₄ and J₅ instead of J₁ in Fig. 1) for plugging in a test meter to measure the grid current in each stage.

If you want further details on this model, send a postal card to me, and I'll mail a full-size chassis drilling diagram, and schematic diagram showing the exact circuit used, to you.

—*Lighthouse Larry*



G-E HAM NEWS

Available FREE from

G-E Electronic Tube Distributors

published bi-monthly by

ELECTRONIC COMPONENTS DIVISION

GENERAL  ELECTRIC

Schenectady 5, N. Y.

In Canada

CANADIAN GENERAL ELECTRIC CO., LTD.
189 Dufferin St., Toronto 3, Ontario

E. A. NEAL, W2JZK—EDITOR

MAY-JUNE, 1958

Printed in U.S.A.

VOL. 13—NO. 3