

• AM • • FM • • TV •
BROADCASTING, RECORDING
AND COMMUNICATIONS EQUIPMENT



If You Didn't Get This From My Site,
Then It Was Stolen From...

www.SteamPoweredRadio.Com

FOREWORD

The equipment listed in this catalog is among the most comprehensive ever offered to the broadcast, communications and associated industries. Gates has prepared this catalog both as an informative book and a buying guide. Though provided to list all major items of manufacture by Gates, this catalog also lists a host of parts and complete equipments manufactured by other reputable manufacturers who have entered into distributing arrangements with Gates. Almost without exception every item listed is carried in stock at either the main Gates factory and warehouses at Quincy, Illinois, or our various factory warehouse branches.

The Gates field sales organization is international in scope. Field sales engineers are located in every area in the United States. Engineering and sales offices are located, in addition to our main office in Quincy, Ill., in New York City and Washington, D. C. Factory warehouse branches are located in Atlanta, Ga., and Houston, Texas. These branches carry large amounts of stock and have competent sales executive personnel to serve you. Sales in Canada are handled exclusively by the Canadian Marconi Company with its branches in every major city in Canada. International sales are handled by the international department of the Gates Radio Company located at 13 E. 40th Street, in New York City.

Gates, established in 1922 and now celebrating its 31st year, is perhaps the oldest manufacturer of radio broadcast equipment in the United States. It has consistently led the industry in new and modern designs. A realistic pricing policy and service policy have made Gates' growth almost phenomenal in a field of illustrious competition. Prices are modest by reason of Gates specializing and manufacturing much of that which goes into a Gates product. No product is designed to meet a price; but, likewise, no product is overdesigned to substantiate a price. By specializing, study can be made of production technique, so the buyer is assured of minimum wasted efforts appearing in the final established selling price.

If it is for the broadcast or communications industry, Gates either has it or can make it. Your inquiries and business are invited, and everyone in the Gates organization will do his very best to justify the confidence placed in us.

THE GATES RADIO COMPANY

MAIN OFFICE AND FACTORIES:
QUINCY, ILLINOIS, U. S. A.

DISTRICT OFFICES: New York City; Washington, D. C.; *Houston, Texas; *Atlanta, Ga.
Also Field Sales Engineers in all areas of the United States.

EXPORT: 13 E. 40th Street, New York City.

Canada: Canadian Marconi Company, Montreal,
with branches in all principal cities in Canada.

*Also stock carrying warehouse.

SALES POLICY

The following describes briefly the general sales policy of the Gates Radio Company

PRICES: Prices are, in most cases, f.o.b. our factory in Quincy, Illinois. In some instances items may be shipped directly from the manufacturer's factory or warehouse — or from Gates' strategically located branches. Prices exclude all Federal, State, municipal or local taxes. Where applicable, taxes may be billed either with the equipment or separately as necessary.

Prices do not include installation supervision or adjustment in the field.

Every effort is made to provide up to date price lists for this catalog. Conditions beyond our control make prices subject to increase or decrease without notice.

GATES PROPOSAL AND ACCEPTANCE is provided the customer in contract form covering all major sales which are subject to the terms and conditions on said contract. These conditions are a mutual protection to both our customers and Gates.

CREDIT: Normal terms are net 30 days. All terms are subject to approval by our Credit Department at Quincy, Illinois.

DELIVERIES: Gates will make every effort to deliver on or ahead of schedule. Failure to do so for any reason shall not hold Gates liable for damage of any kind; nor shall delays in delivery relieve the purchaser of his obligation of performance.

PATENTS: All Gates equipment is manufactured under patents owned by Gates or under United States patents which Gates is licensed to use. Those products listed herein not manufactured by Gates are produced under patents owned or licensed to the particular manufacturer, to the best of our knowledge. Gates does not assume liability for infringement on any patent on a product not manufactured by Gates.

GUARANTEE: The very liberal Gates guarantee covers all Gates manufactured products. Equipment not of Gates manufacture is covered by the warranty of the actual manufacturer. Our performance under the guarantee is limited strictly to replacement or

repair at our option upon receipt of proper notice from the purchaser. Returns are to be made only upon our authorization, which will include instructions and other necessary details. All items so authorized are to be shipped via insured prepaid transportation. The liberal guarantee is included in most Gates instruction books and is available on request.

PACKING AND SHIPPING: Packing costs are included in the prices of all items for domestic shipment. However, where products are to be shipped outside of the United States, or where special packaging is required, a slight additional packing charge is made. Special packaging procedures required by various Government Agencies, such as joint Army-Navy packaging specifications, are subject to additional charge regardless of destination.

DAMAGE IN TRANSPORTATION: Immediate inspection should be made promptly upon receipt of all goods. In case of any damage, no matter how small, the necessary inspection report should be obtained from the delivering carrier. Furthermore, notification should be sent to Gates Radio Company, Quincy, Illinois, within seven days of receipt of shipment.

MODIFICATIONS AND IMPROVEMENTS: As Engineering is constantly making improvements, Gates reserves the right to alter without notice any products, provided said alterations do not adversely affect the performance or lower the quality. In case any alteration increases the price, Gates will notify the purchaser before shipping. Gates reserves the right to withdraw any item from sale without prior notice.

OTHER CONDITIONS: All orders—with or without down payments—are subject to official acceptance by Gates' Office at Quincy, Illinois. These terms and conditions are stated for the purpose of better mutual understanding. However, Gates customers have become well acquainted through the years with the warm and genuine Gates policy of fairness.

Nothing herein is to be construed to relieve Gates of the obligation of supplying high quality material and equipment.





Gates Factories

Two modern factories produce all products manufactured by Gates.

Above is the 50,000 square foot 100% sprinklered plant located a few feet from the Mississippi River and with private railroad siding. This plant is located at 123 Hampshire Street in Quincy . . . only 3 blocks from the business and hotel district.

Below is the new modern Gates manufacturing plant completed in May, 1953. Located on a seven acre plot at 30th and Broadway in Quincy, ample room is provided in this spacious new 100% sprinklered building for large production operations and for outside field testing as well.

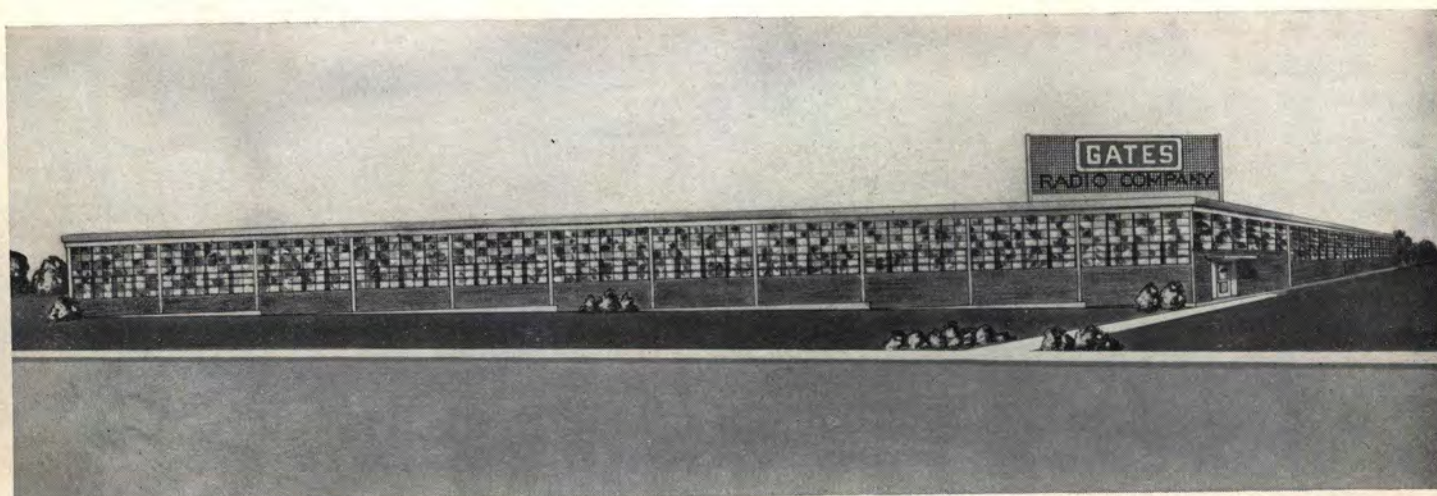

GATES "POWER SAVER" 5-10 KW TRANSMITTERS

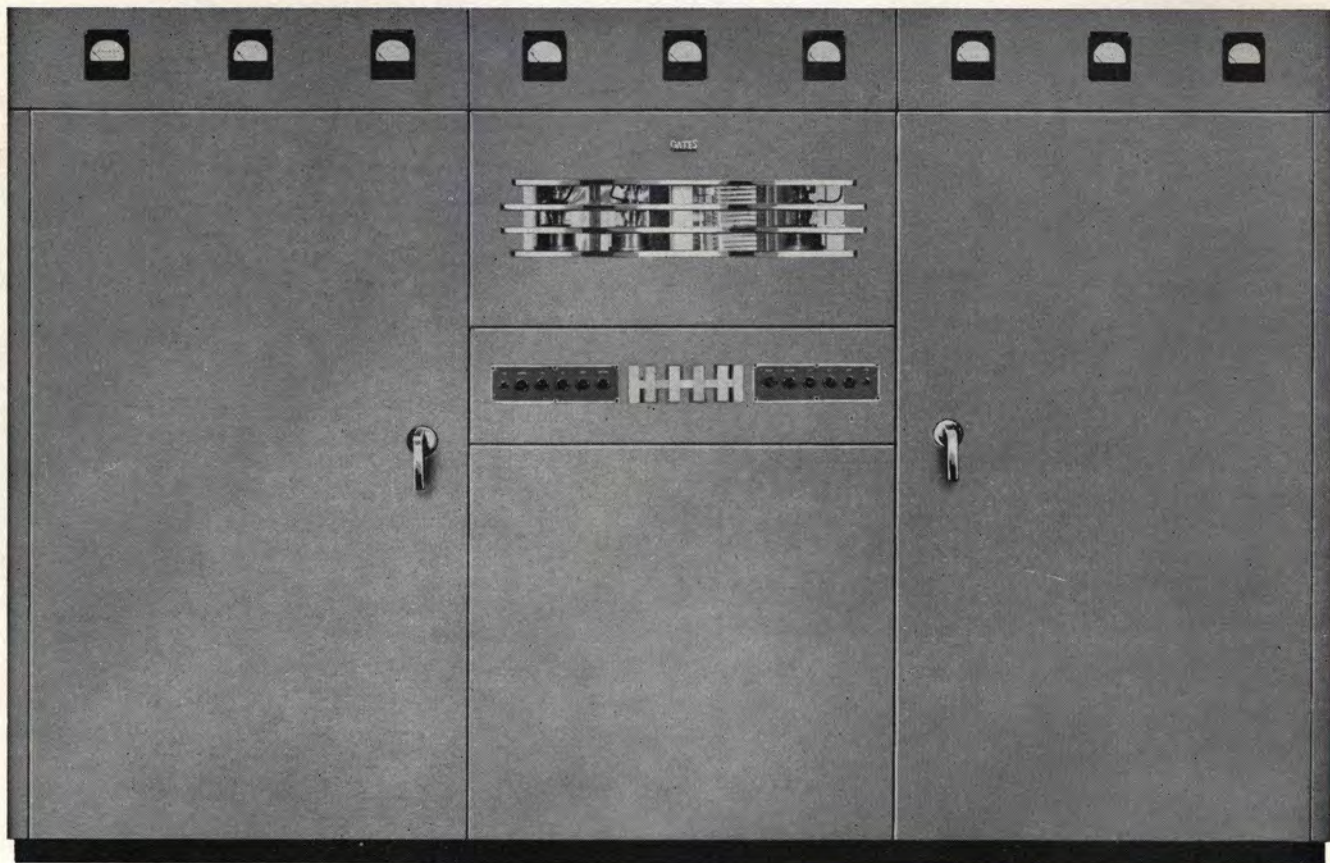

The Transmitter

A NEW modern much lower cost tube complement, stamina and economy of ownership keynote the new Gates BC-5B and BC-10B broadcast transmitters. During the past three decades—since 1922—Gates, in its constant and close association with the industry, has consulted with broadcast men everywhere. With all respect to our contemporaries, we firmly believe you will not find anywhere a transmitter of such consummate design or such distinguished engineering and attractiveness.

New Modern Design Assures Lower

— QUALITY —

— CONVENIENCE —

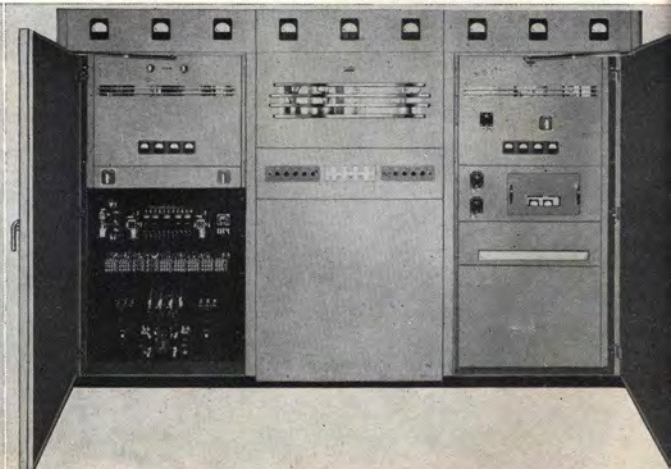
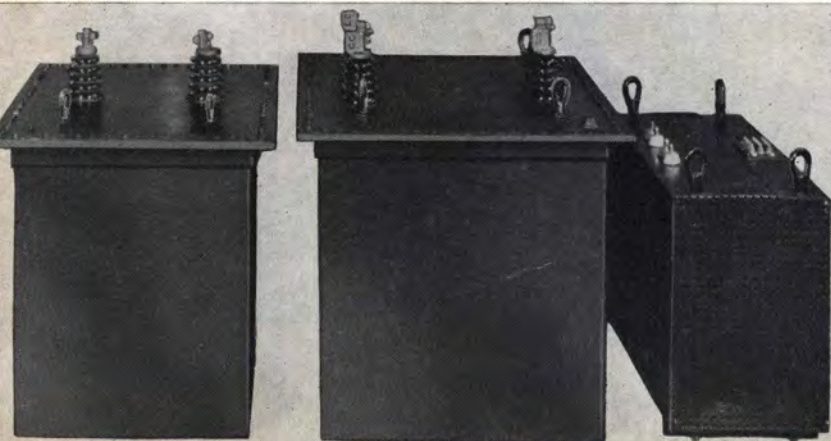

—Entirely New . . . With Low Cost Tube Complement

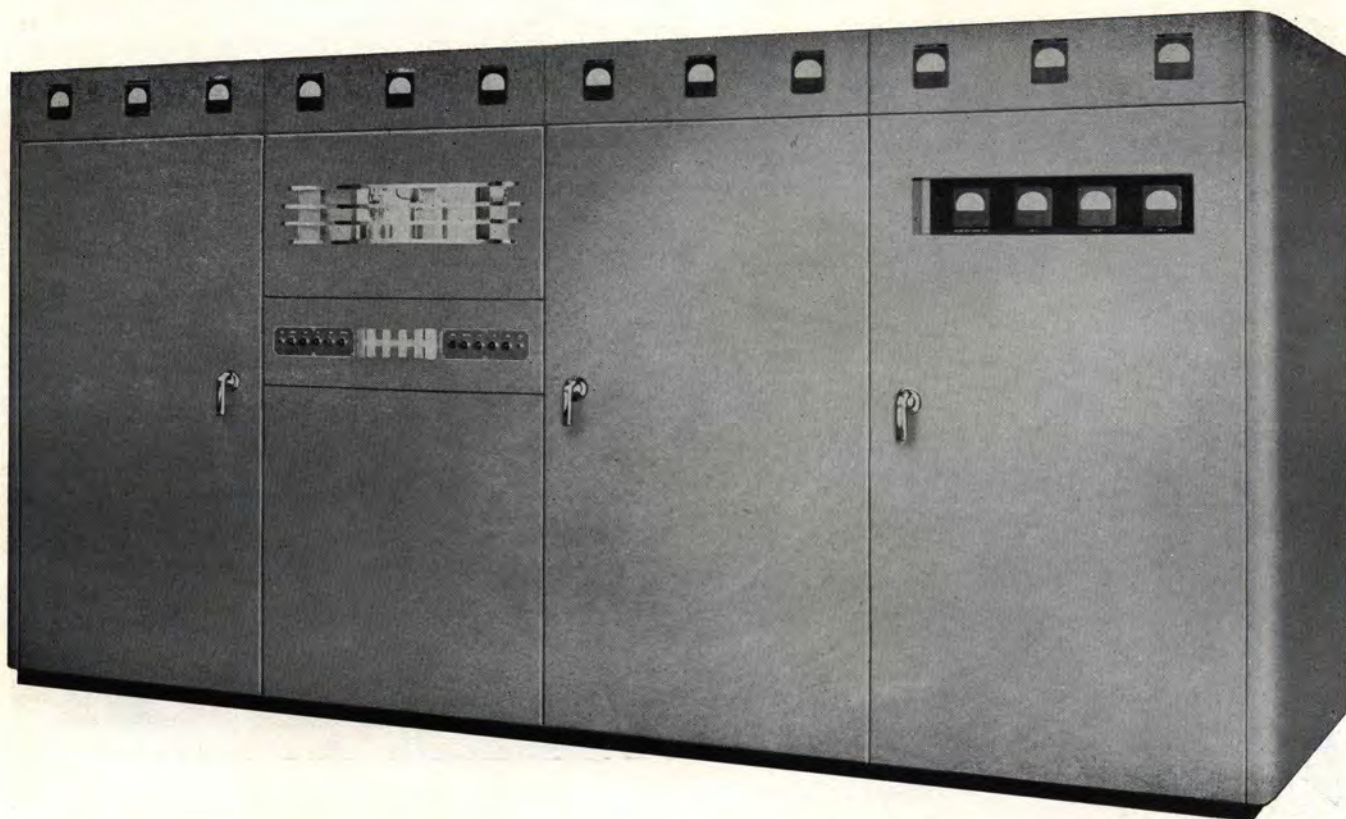

The Transmitter
With Phasor

THERE is romance in any business when, through a long period of years, a company becomes an integral part of the life, the problems and the success of its customers. These new Gates broadcast transmitters are so well built—so economical in operation—so fine in performance that we know our friendships and prestige will ever be further cemented through the use of these new and modern broadcast equipments for five and ten kilowatts.

Operation and Maintenance Cost

— SIZE —

— NEW —

— COMPLETE —

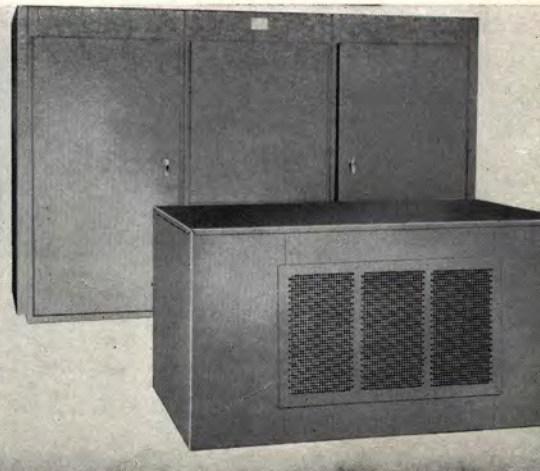
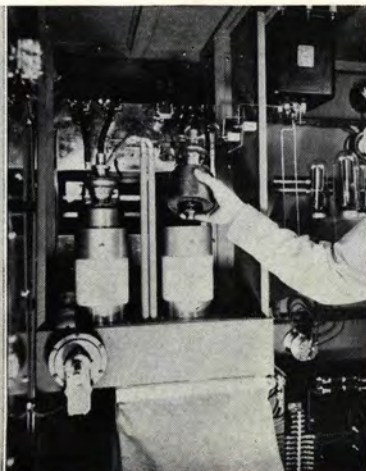
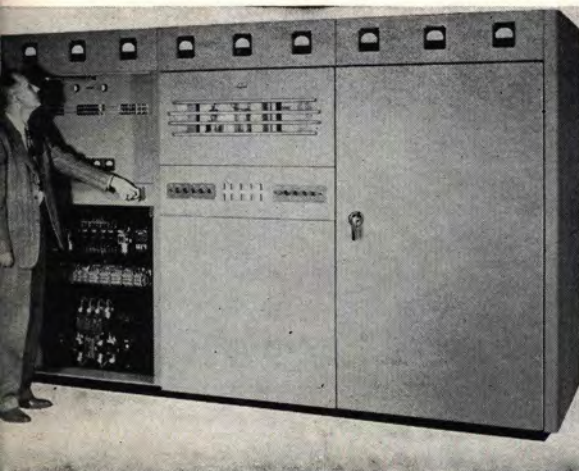

GATES BC-5B AND BC-10B FIVE AND TEN KILOWATT

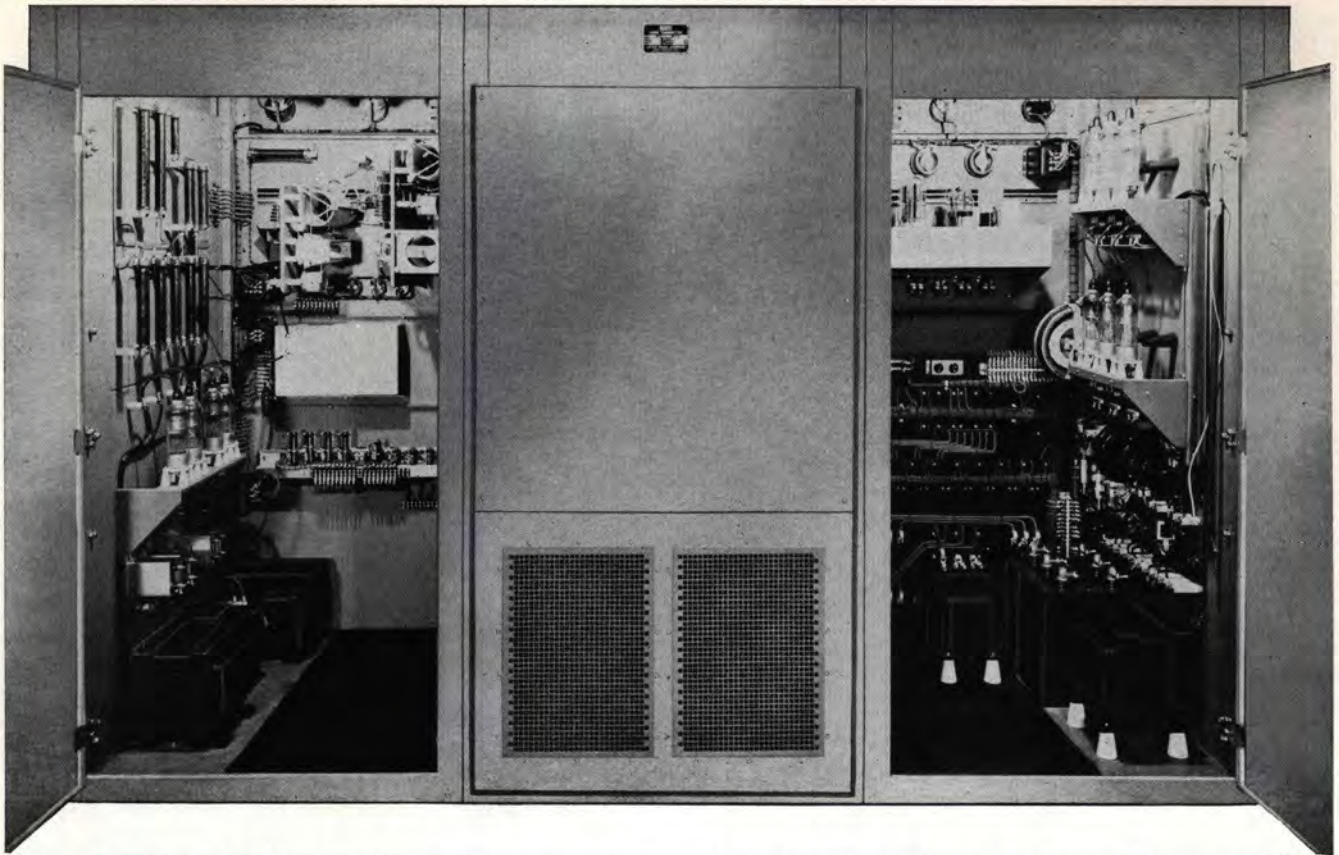

Savings—By the use of new modern design tubes, fully proved in abusive war time radar service as well as high power FM, the tube cost has been reduced to about one-half that of earlier equipment. These same tubes, associated with the new distinctive Gates design, effect line load reduction averaging three kilowatts per hour. Based on the use of only one set of tubes per year and the lesser power consumption, the Gates BC-5B, 5000 watt transmitter, will operate for \$1000.00 per year less than earlier design 5KW transmitters.

Words—are easy to say. To back these words all older models 5KW transmitters using 891R or 892R tubes had a tube cost of over \$1300.00. In the Gates BC-5B transmitter a tube set costs \$786.00. Based on a savings of 3 kilowatt hours over earlier models, and at a power rate average of 2½¢ this is 7½¢ per hour or \$518.00 annually on an 18 hour day. All this is done with much improved performance and reliability.

Leadership—Gates performance has never meant so much as it does today. This is also true of Gates quality, Gates originality and Gates value. The

Gates record—a priceless heritage of 31 years of the best—remains unbroken. The new Gates BC-5B and BC-10B broadcast transmitters are the finest of a fine line that has exemplified leadership throughout the years.

Beauty—To the engineering eye means rugged materials, ease of servicing, and good workmanship. For those with an inherent appreciation of genuine quality the Gates BC-5B and BC-10B broadcast transmitters will be appealing. All transformers are cased and impregnated, with some larger units oil filled. The engineer can walk through the back doors, stand inside on rubber mats which line the enclosure floor, and change tubes or make adjustments with care and safety.

Installing—The transmitter proper is comprised of three complete cubicals, with a fourth for the phasor when needed. Each bolts together. No cabling is required, only jumpers between terminal strips located side by side as one cubical fits to the other. This saves days of installation labor. Cubical design requires minimum parts removal for shipment. The power and modulation transformers and modulation reactor are the only external

CONTROL

TEN KW

PROTECTION

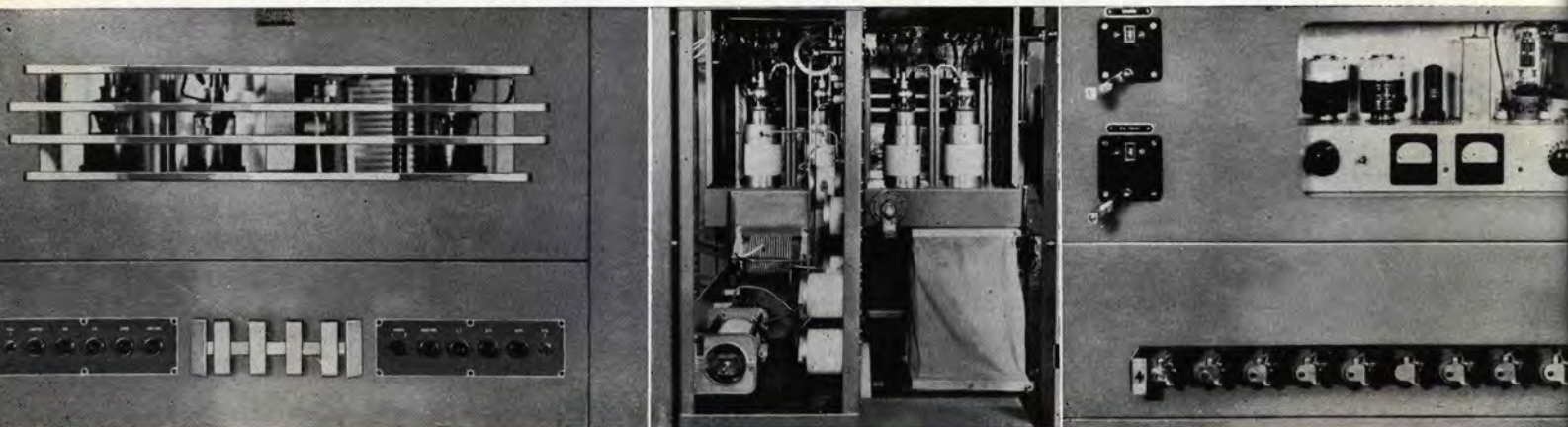

TRANSMITTERS Lead in Quality, Engineering and Results

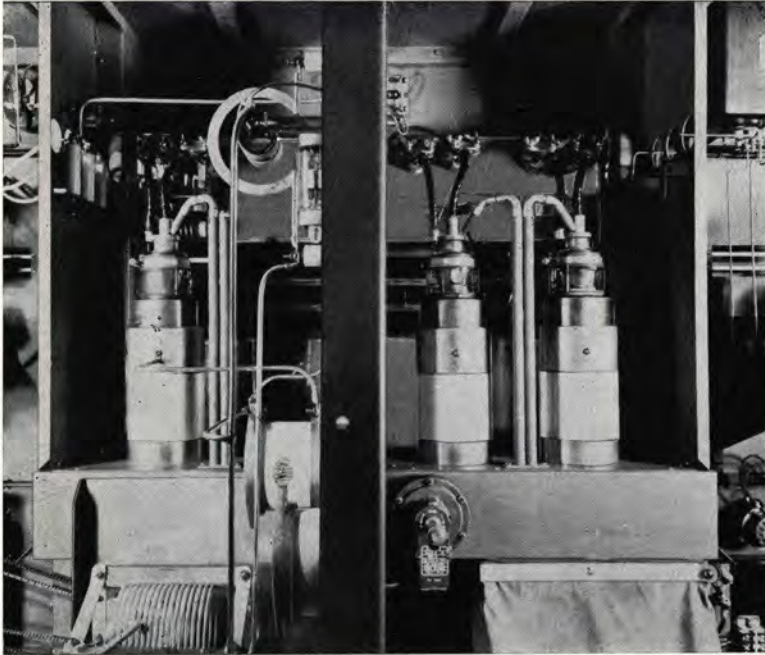

Tubes and generous flow of air are important in Five and Ten Kilowatt design. These two illustrations tell in picture the well engineered cooling system from blower to tubes.

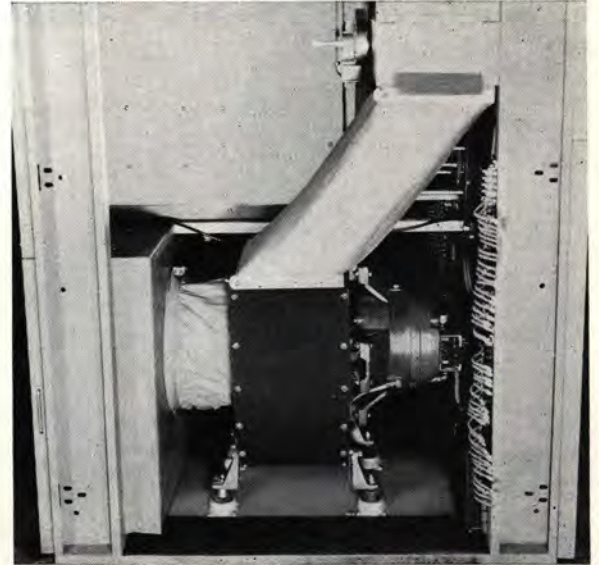

units. A protective cover may be had for these where the transmitter is placed in an open room.

Circuit—Straightforward full-fledged circuit design characterizes all Gates engineering. Feedback is employed, but as a helpful adjunct and not a necessity. Five RF stages, four push-pull audio stages, and three power supplies with excess capabilities of each, provide the smoothest modulated carrier you have ever employed.

Cooling—Is new, improved and complete. A large double cushion 800 C. F. M. blower, powered by a 0.43 H. P. motor, sends several times the required air around the power tube envelopes and on their filament seals. Excess air is sent via deflecting baffles to all parts of the three cubicals that make up the transmitter. An air pressure switch, located adjacent to the tubes, gives sensitive diaphragm protection. Added cooling to the base of each high voltage rectifier is provided by a separate and smaller blower.

Protection—Is as complete as money can buy. Overload and underload relays on each important operating stage, 8 in all. A full complement of time delay, overload, condenser discharge, power change, air interlock and door interlock relays, plus seven circuit breakers, protects the transmitter at each circuit point.

Dead Front—Means opening front doors without exposed high voltage and being able to tune all circuits, check modulators, adjust crystals, check relays

and manipulate all operating functions without disconnecting the carrier. This is Gates design for the broadcast engineer.

Tubes—Are important in operating costs. The 3X2500F3 power tubes have been used for years and are proven high frequency tubes where abuse is great. In the much lesser demands at AM frequencies the 3X2500F3 tubes will provide phenomenal tube life. The single phase thoriated tungsten filament assures lower noise level than otherwise possible. Gates engineering has never stood still. We know by exhaustive tests that these tubes are superior to those previously used, even in eminent Gates predecessors.

Why—Can Gates make a better transmitter and yet fit into the financial plans of the most restricted budget? There is the distinction of difference in the Gatesway. We, at Gates, are continually looking for new ways, never being satisfied with the old. Gates engineering has never stood still. This engineering creeps into the smallest nook of our operations. Gates makes much that it uses—enclosures, machine parts, coils and inductors, solenoids, tube sockets and more. No double mark ups, less freight charges from one supplier to another, and less costly delays in production. Of course, alert engineering means the better way to do a job at lower cost. In these new five and ten kilowatt transmitters we are stubbornly confident you will enjoy the experience of owning the finest that learned engineers can create.

DISTRIBUTION

DRIVER

TANK

RECTIFICATION

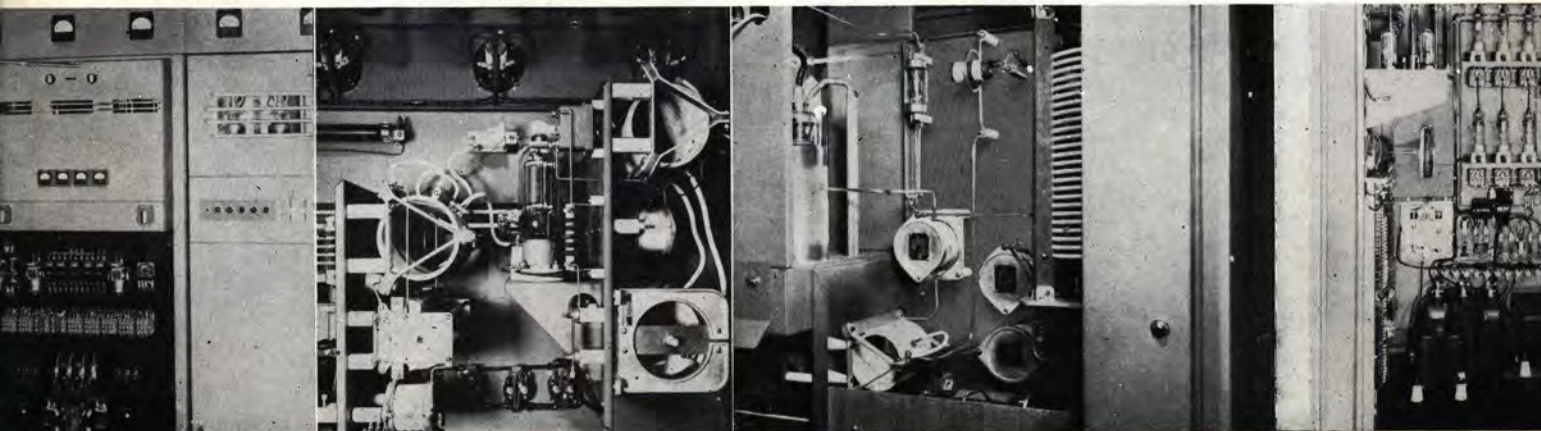

Technical Detail BC-5B and BC-10B Transmitters

	BC-5B (5000 watts)	BC-10B (10,000 watts)
Rated Power Output	5000 watts	10,000 watts
Maximum Power Output	5500 watts	10,500 watts
Power Reduction	to 1 KW	to 5 or 1 KW. (as required)
Frequency Range ..	535-1610 Kc.*	535-1610 Kc.*
*As ordered. Also lower or higher frequency on special order.		
Load	40-280 ohms	40-280 ohms
Frequency Stability	±10 cycles	±10 cycles
Power Line Input Requirements	230 V, 3 phase** 60 C	230 V, 3 phase** 60 C.
**Other voltages or frequencies on special order.		
Power Line Demand	<u>5 KW</u> <u>1 KW</u>	<u>10 KW</u> <u>1 KW</u>
Carrier	12.5 KW 9 KW	21 KW 9.5 KW
Average Program.....	15.5 KW 9.5 KW	23 KW 10 KW
100% Sine Wave Modulation	18.5 KW 10 KW	30 KW 10.5 KW
Power Factor	90% 78%	90% 78%
Carrier Shift: 50-7500 Cps. (Up to 100% Mod.)	3% 2%	4% 2%
Input Audio Impedence	600 ohms	600 ohms
Input Audio Level	+14 DBM	+14 DBM
(Audio level automatically changes on power reduction)		
Frequency Response:		
30-10,000 Cps.	±1.5 Db.	±1.5 Db.
100-7500 Cps.	±1 Db.	±1 Db.
Distortion at 90% Modulation:		
50 to 7500 Cps.	3½% or less	3½% or less

	BC-5B (5000 watts)	BC-10B (10,000 watts)
Noise: Unweighted below 100% Modulation	60 Db.	60 Db.
Net Weight	8,000 lbs.	8,400 lbs.
Gross Packed	9,100 lbs.	9,800 lbs.
Cubage	317 ft.	342 ft.
Length with Phasor Cabinet	165" L. x 78" H. x 48½" D.	
Length of Transmitter	125" L. x 78" H. x 48½" D.	
Space Required for Modulation Transformer, Power Transformer and Reactor	36" W. x 72" L. x 36" H.	36" W. x 96" L. x 36" H.
Front and Back Door Radius	40"	40"
Largest Cabinet or Cubicle Size (for Building Entrance)	51" W. x 56" D. x 80" H.	

ORDERING INFORMATION

Model BC-5B Transmitter, complete with one crystal and oven and complete set of tubes. **Cat. BC-5B**
Complete 100% set of tubes for BC-5B Transmitter. **Cat. M3701**

Model BC-10B Transmitter, complete with crystal and oven and one set of tubes. **Cat. BC-10B**
Complete 100% set of tubes for BC-10B Transmitter. **Cat. M3825**

Extra crystal and oven. **Cat. JK5TM**

Protective covering for trio of power, modulation and reactor units where transmitter to be located in open room. **Cat. PCH-1**

Phasor, subject to special quotation on engineering requirements.

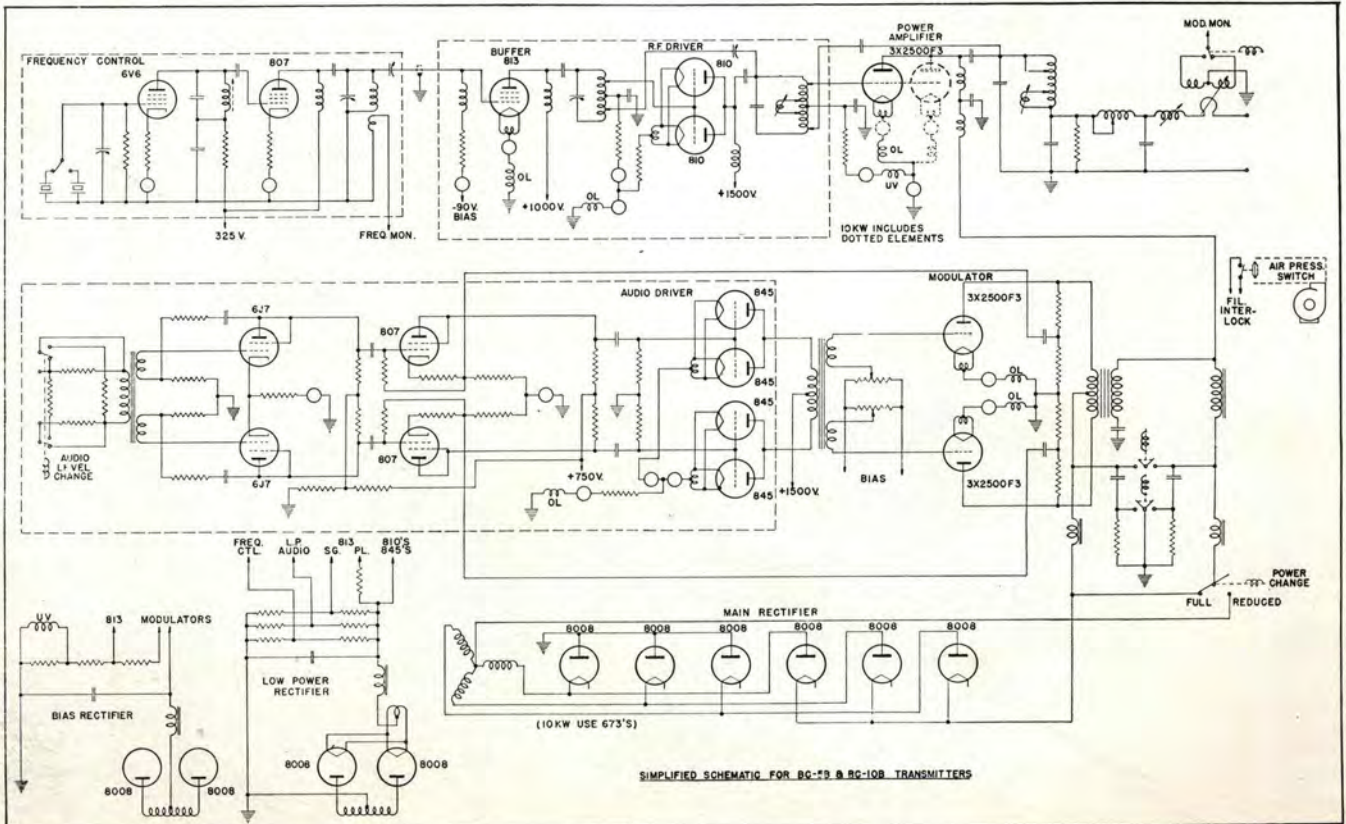

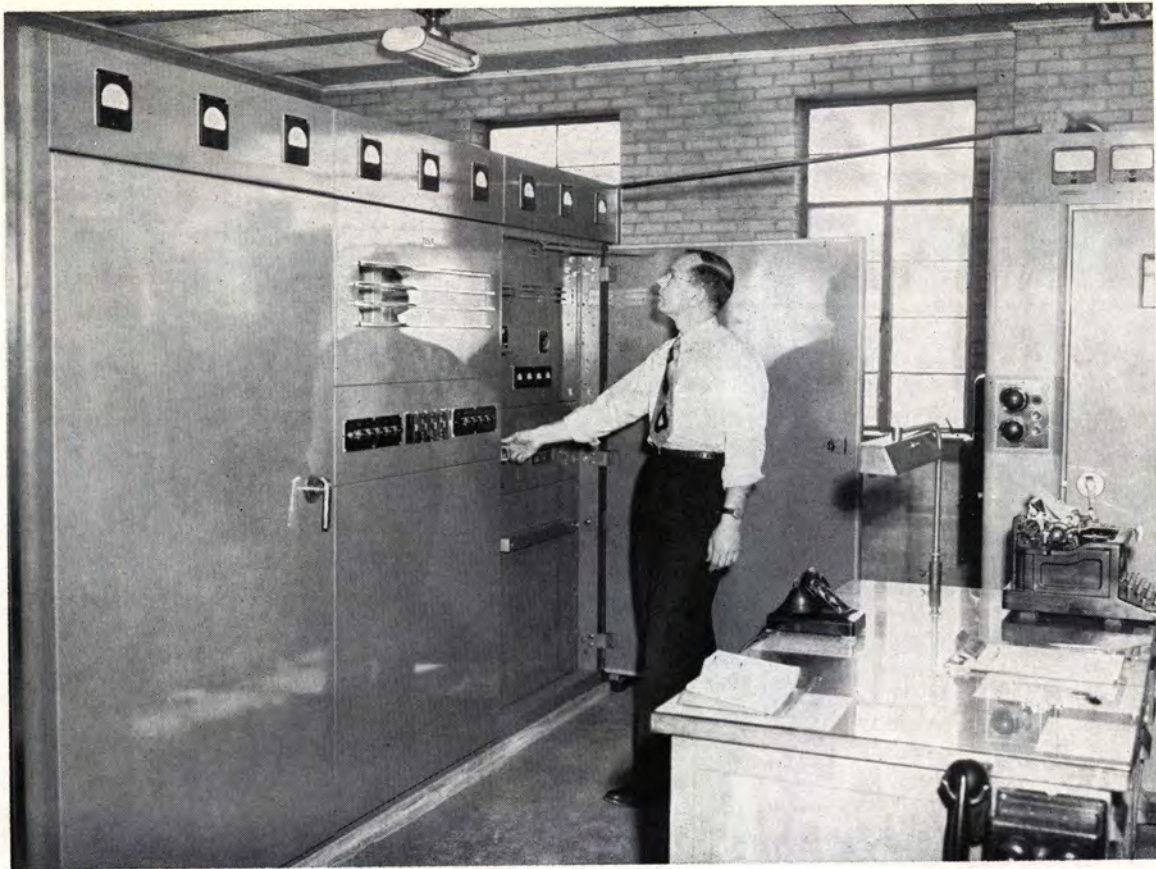

Above—BC-5B 5000 watt Gates broadcast transmitter installed at Radio Station WTAD, Quincy, Ill., CBS outlet and pioneer midwestern station.

Below—Gates BC-5B 5000 watt equipment with five tower phasing equipment in matching cabinet at WENE, Endicott, N. Y.

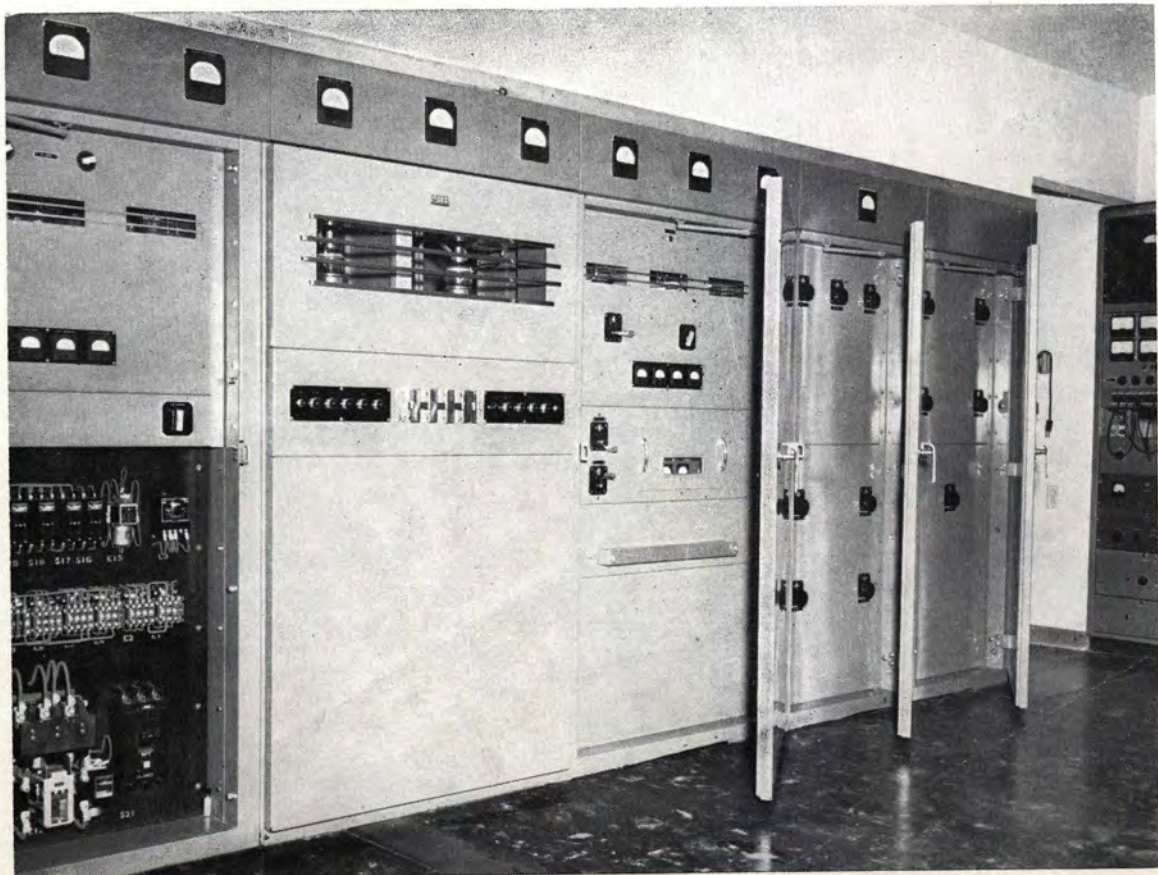

The Dependable Gates BC-1F Air-Conditioned One KW Transmitter

Probably more premeditated engineering has been placed in the new Gates air conditioned one thousand watt transmitter than any similar equipment in broadcast history. Gates engineers are practical men, too. The new dependable Gates BC-1F broadcasting equipment does have, as well as near perfection electronically, good mechanical engineering, studied parts placement, distinguished styling and—complete air-conditioning.

AIR, when properly circulated in clean form, is a radio engineer's assurance of dependable operation void of offages. BC-1F air changes four times each minute inside a semi-pressure enclosure. This air cools not only tubes, but reaches into every nook and corner of the cabinet.

PARTS must be placed in the path of this air. Parts dissipating most heat are in the direct stream, such as power resistors, all at the top of the enclosure. Those dissipating less heat are in the secondary air stream. As a result, one section of the cabinet enclosure is as cool as another. Cool air forces out hot air every 15 seconds. This cool air is clean filtered air. Dust cannot come in; but even the small amount that might be let in, such as when opening a back door, is immediately forced out by semi-pressure cabinet design.

ROOM is predominant. The dependable Gates BC-1F is a large transmitter—no scuffing the back of a hand scraping across a fuse clip or condenser plate to reach a tube. You can't assure air cooling without room. Large oversize parts are impossible without a place to put them. Quality and size go hand in hand and the dependable Gates BC-1F is a sizable equipment.

COMPLETE as a broadcast transmitter can be made, adequately describes the dependable Gates BC-1F. Thirteen meters, nine relays, dual circuit breakers, veeder counter tuning, variable coil resonance control, T network loading, ten second accessibility of the smallest and most concealed part, four power supplies, feedback, impregnation and casing of all transformers large and small, welded construction, dead front control—everything with a plus. The dependable Gates BC-1F is mid-century's servant to a critical listening public.

GATES RADIO COMPANY
Quincy, Illinois, U. S. A.

GATES Air Conditioned Transmitter

Model BC1F==1000 watts==AM



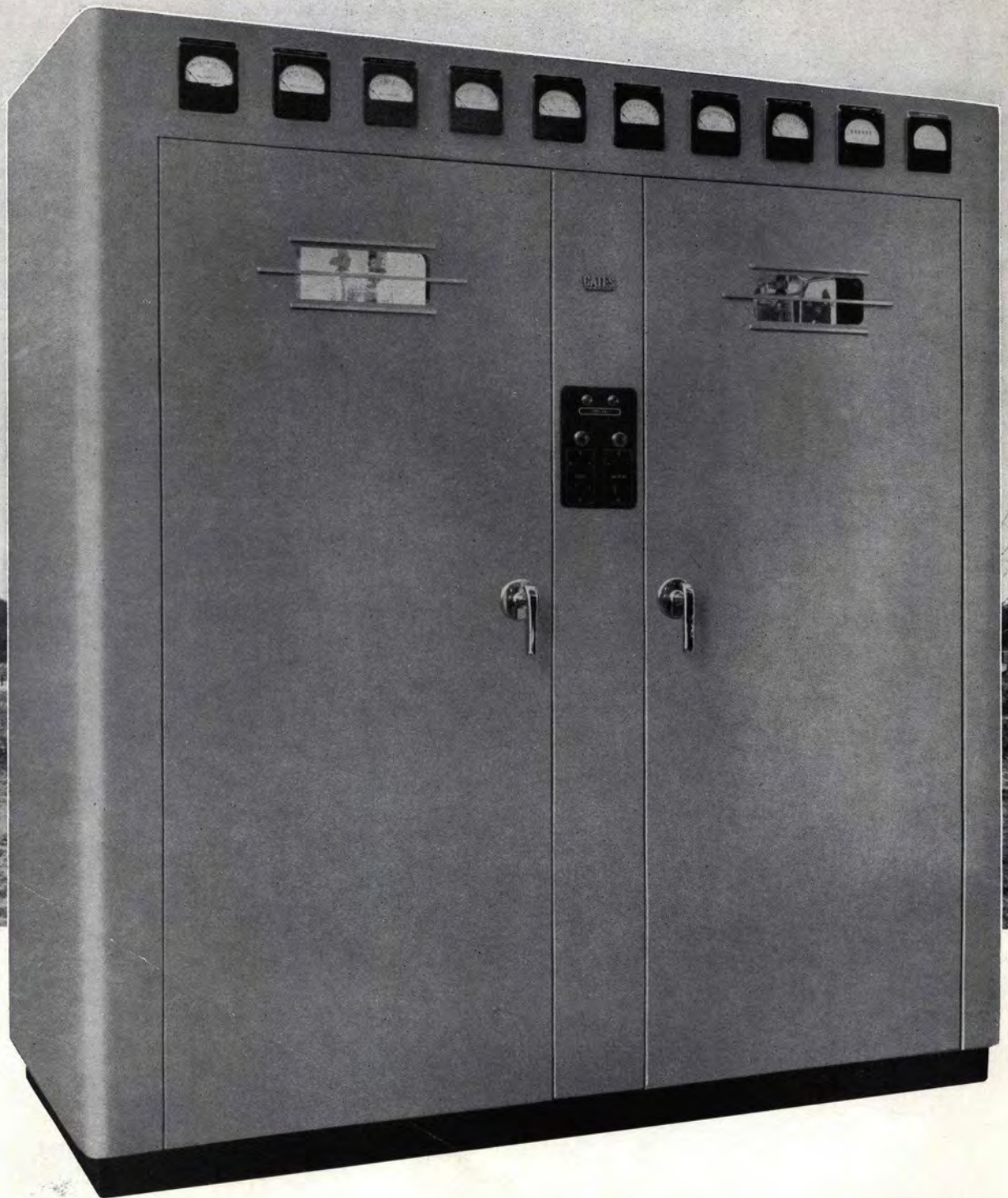

Engineered for a lifetime performance—massive and smartly styled—attractive to the quality eye, the Gates BC-1F transmitter is completely new from oscillator to power amplifier.

Ten four-inch meters, plus three others—four power supplies—inverse feed back—quad overload relays and ten-second accessibility to any part are just a few features, topped only by an air cooling system that provides for lifetime performance.

BC-1F CONSTRUCTION DETAIL

(1000/500 Watts A. M.)

The dependable BC-1F Transmitter is a large roomy equipment where cramping of parts is unnecessary and where each part is located properly for best electrical position. The air conditioning of the BC-1F Transmitter involves not only proper distribution of air throughout the cabinet, but also careful study and then proper location of each part in relation to the air stream. As a result the clean fresh filtered air is distributed in turbulence throughout the cabinet and each part, large and small, operates at its best.

Radio frequency design of the dependable BC-1F transmitter consists of a two-stage oscillator-intermediate amplifier unit which drives a third intermediate power amplifier and excites the pair of 833A power amplifier tubes. The oscillator-intermediate amplifier unit can be completely removed in eight seconds, being held to the cabinet by two catches. Front adjustments, including crystal air gap, tubes, etc., may be reached instantly by removing the front protective cover as shown on this page.

The loading of the transmitter is accomplished by a pi-network, completely new in design, using continuously variable coils and eliminating variable condensers. The loading system employed provides extremely low harmonic radiation to meet the most rigid FCC standards.

Audio construction employs four push-pull stages incorporating 6 Db. of feedback between the modulator tubes and the first audio stage. By using all push-pull stages and feedback, low noise and distortion is easily accomplished. There are thirteen meters on the BC-1F transmitter, ten of which are large 4" Westinghouse meters, including dual modulator meters and an "Hours Consumed" meter. No pushbutton metering is employed. All circuit arrangements in Gates transmitters are straightforward, time proven and employ a full complement of material. The modulation reactor will be found in full size in the dependable BC-1F equipment. Individual filament transformers for each circuit and the largest relay complement ever provided on a 1 KW transmitter, including four overload relays plus a master relay giving a modified form of supervisory control, are all new and in many cases exclusive Gates features.

Alert attention has been paid to termination of all circuits, eliminating clumsy arrangements to connect frequency and modulation monitors, power lines, transmission lines, etc.

Of top importance—every part in the transmitter, regardless of its size or nature, can be reached within ten seconds. The audio driver deck hinges down, the oscillator deck clips on, all for instantaneous servicing.

The dependable BC-1F Transmitter is attractively finished in hand-rubbed gloss medium gray trimmed in black and chrome. It may be had in other special colors with only slight delay. It operates from standard power line facilities, which is a 230 volt circuit with a common neutral, single phase. There is no need to provide special three phase service for the BC-1F Transmitter.



Oscillator and first intermediate amplifier with front slip-on cover removed. Entire unit can be removed in 8 seconds for servicing.

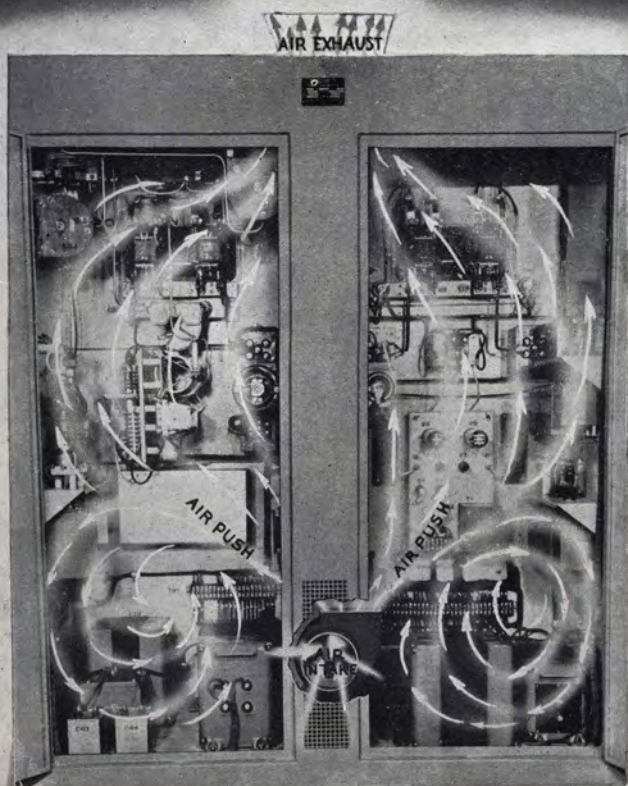
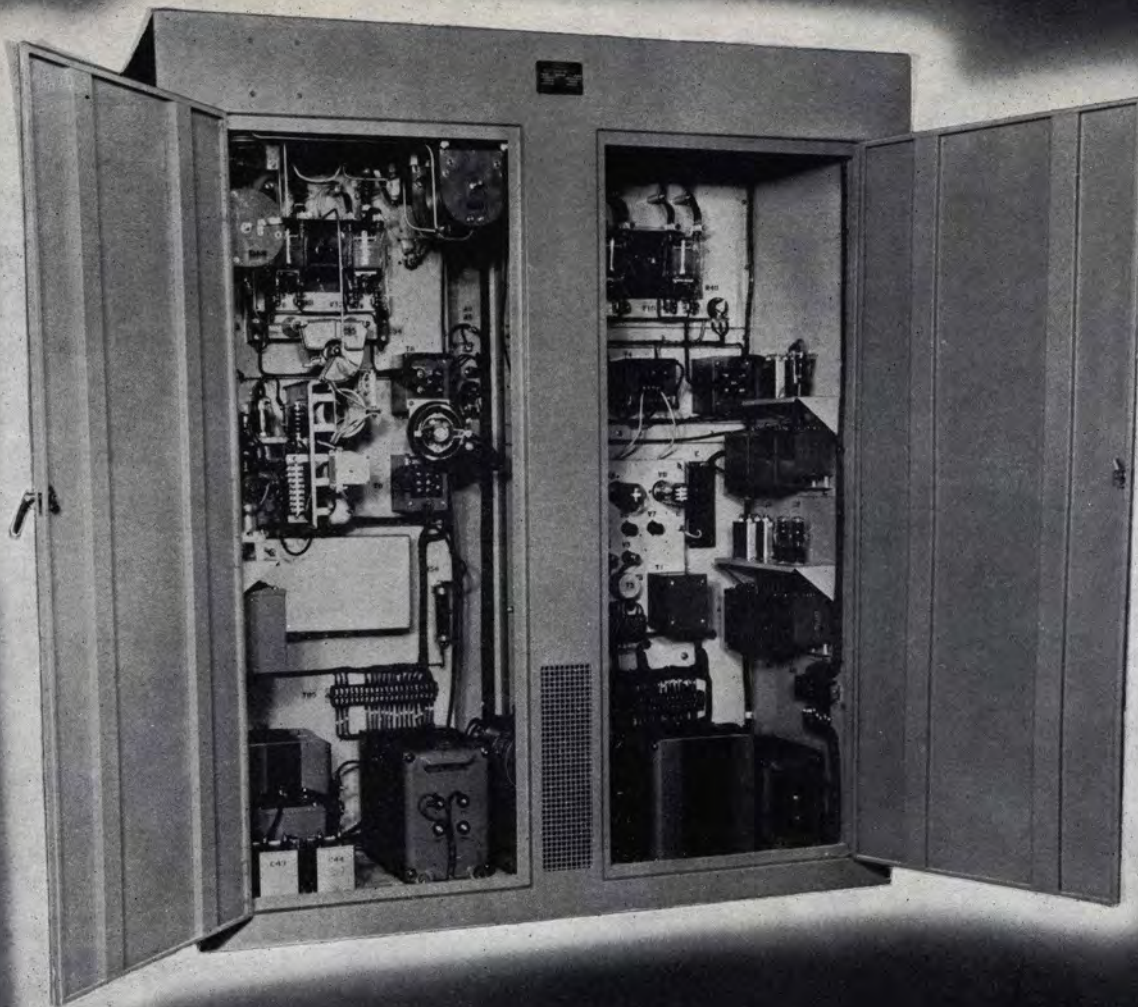

Performance Is Only As Good As the Cooling

BC-1F practical engineering is predominant. Note the top illustration—observe roomy construction and careful thought given to placement of each part.

Observe the left illustration of air circulation. Cool fresh air is drawn in large volume by the quiet high speed blower. The filtered air is forced to all parts of the cabinet—four times as much air each minute as the cabinet will hold.

By close observation you will note the intermediate amplifier and its edgewound coil will permit unobstructed air flow. A glance discloses all transformers located below tubes. Power resistors are at the top where the air exhausts. The attentive eye will see the two rheostats located in the direct air stream.

The dominant principle of engineering is low operating temperature with freedom from dirt or dust. Without these, trouble-free operation would be difficult to expect. The dependable Gates BC-1F transmitter is the first 1000 watt transmitter where cooling has been primary instead of an afterthought. It can be logically said the BC-1F transmitter is engineered for lifetime performance.

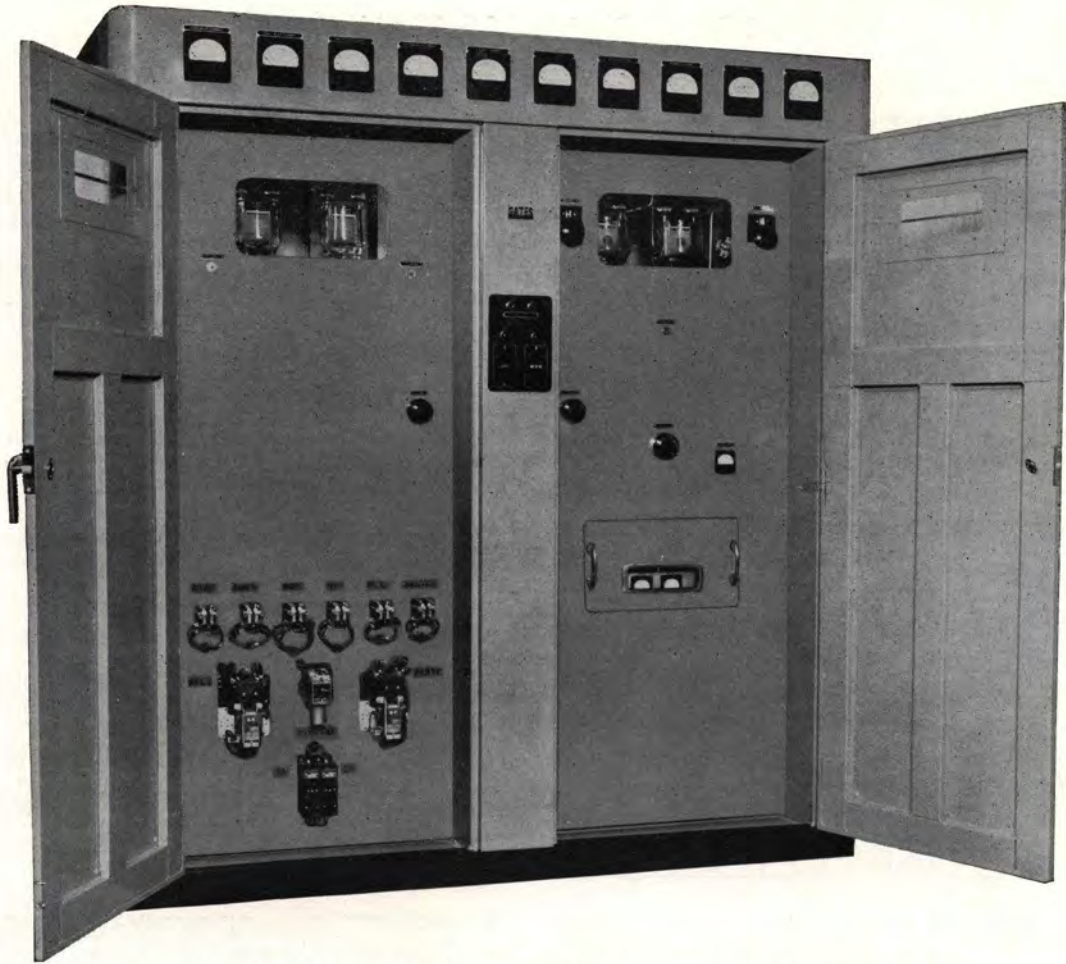

The front of the Gates BC-1F Transmitter has all controls behind a pair of firm free handling doors. As the "dead front" principle is apparent, no door interlocks are required. Note all relays and circuit breakers are at the finger tips.

The BC-1F Transmitter Is Better

The final decision can only be made by comparison. Consider, however, these features which will not likely be found in competitive equipments:

- (a) Full metering complement—thirteen in all.
- (b) Scientific air cooling—the first transmitter in the 1000 watt class ever manufactured where cooling was as much of engineering as the circuit itself.
- (c) Ten relays in all, plus two circuit breakers. Four relays are individual overload relays to assist the operator in locating the point of the overload.
- (d) Complete elimination of variable air condensers in the final tank circuit and antenna coupling circuit, using in its place continuously variable edgewise wound inductors, eliminating possibility of arc-overs.
- (e) Complete serviceability—ten-second accessibility to the most minute part in the equipment.
- (f) Low power line consumption through efficient design. This means dollars saved.
- (g) Low tube cost—remembering the air cooling system greatly increases the life of tubes.
- (h) All controls behind front doors and all tuning controls accessible on the front, including modulator balance controls, crystal air gap and every other important or semi-important control. The most important feature of all, nine months of engineering and planning before the pilot model was accepted for production.

In offering the BC-1F transmitter to the broadcast industry, we at Gates do so with the simple statement that it is a transmitter already distinguishing itself in broadcast stations everywhere—made by craftsmen—designed by skilled engineers—proved with a host of satisfied users—The dependable Gates BC-1F 1000 watt broadcast transmitter.

SPECIFICATIONS BC-1F TRANSMITTER

CARRIER FREQUENCY RANGE—540 to 1600 kc. as ordered.

CARRIER FREQUENCY STABILITY—Plus or minus 10 cycles.

CARRIER POWER OUTPUT—1000 watts or 500 watts as ordered and as rated by FCC.

R. F. HARMONICS—Below .05%.

A. C. POWER INPUT—230 volts (115/115 volts) single phase. Plate transformer tapped for 210, 220, 230 volts. Filament and plate voltage controlled by rheostats on front of cabinet.

POWER CONSUMPTION—1000 watts output; average program level, 4400 watts; 100% modulation, 4900 watts; 500 watts output; average program level, 3550 watts; 100% modulation, 4400 watts. Note: for good regulation provide at least 6 kw. service.

TUBES USED—One each 6V6, 807, 813, two each 6J7, 6J5, 845, 575A, 866/866A.
Three each 5U4G. Four each 833A.

FEED-BACK—Six decibels.

OUTPUT CIRCUIT—Pi-network tank and T-network output coupling provide low harmonic radiation. Continuously variable coil tuning eliminates variable air condensers and possibility of arc over.

OUTPUT IMPEDANCE—40 to 300 ohms as ordered (unbalanced).

FREQUENCY RESPONSE—Plus or minus 1 db. 30-10,000 cycles.

DISTORTION—3% or less 50 to 7500 cycles at 90% modulation.

NOISE—60 db. or better below 100% modulation.

AUDIO INPUT—500/600 ohms at 0 dbm.

CARRIER SHIFT—3% or less from 0 to 100% modulation.

SIZE AND COLOR—78" high, 72" wide, 33" deep. Supplied medium gray trimmed in black and chrome.

WEIGHT—Domestic packed, 3100 lbs. Export packed, 3450 lbs. Cubage with tubes, 255.

DOOR SWING—Front, 25". Rear, 28".

METERING—Ten 4" meters across top including dual modulator meters and "Hours Consumed" meter. Three smaller meters for oscillator, intermediate amplifier and 813 grid drive.

COOLING—Forced air.

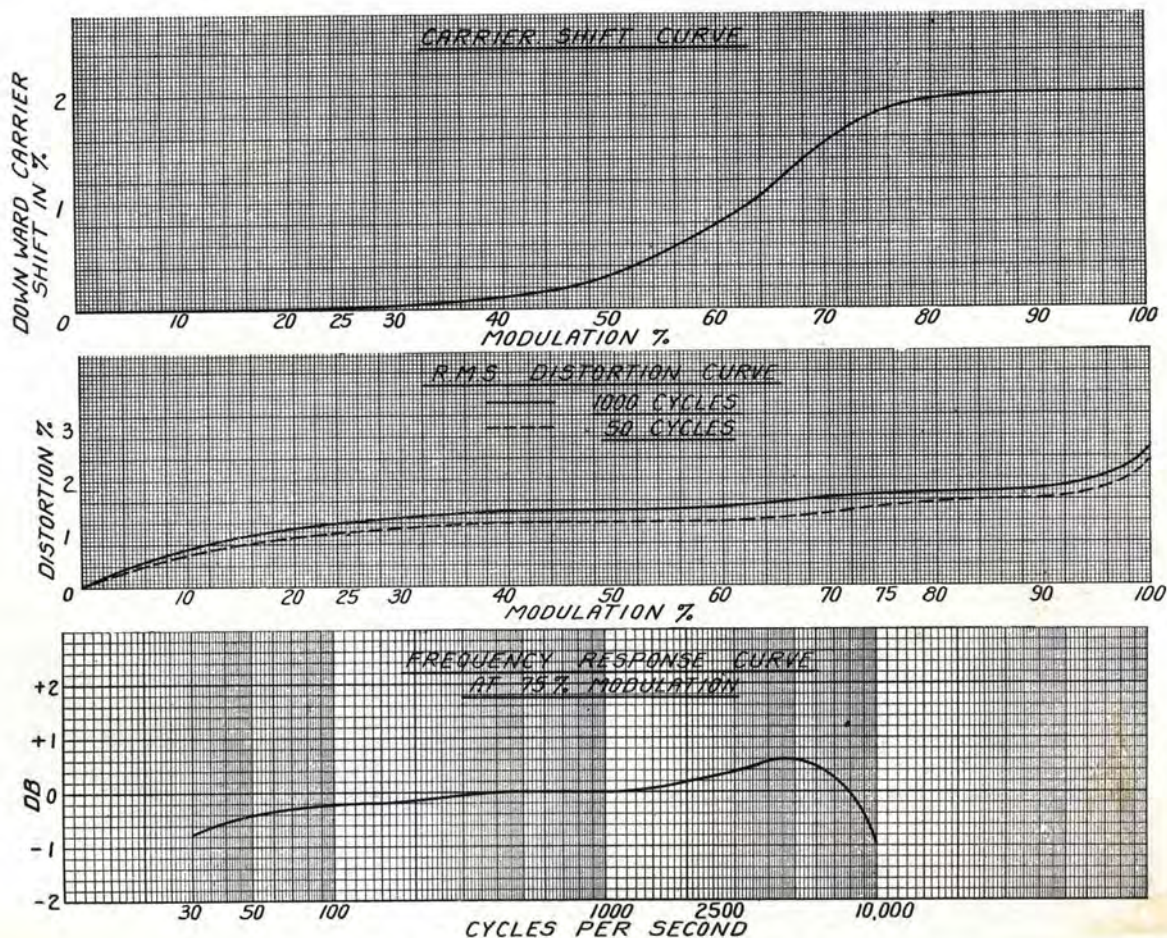

Typical BC-1F Transmitter Characteristics

SPECIFICATIONS BC-1F TRANSMITTER (continued)

RELAYS—Filament start relay, plate start relay, time delay relay, bias voltage relay and four overload relays, one each for R. F. driver amplifier, R. F. power amplifier, audio driver amplifier and modulators. Also master relay. All front of cabinet access.

MONITOR PROVISIONS—Direct terminal connections. Gates MO-2890 Frequency Monitor connects to output of first intermediate amplifier. Gates MO-2639 Modulation Monitor connects inductively to tank coil. Pick up loop is part of equipment. Other makes of monitors may be used, of course.

AUDIO MONITORING—Direct loudspeaker connection (500 ohms) to filament return of R. F. power amplifier gives off the air monitoring.

FCC APPROVAL—Full FCC approved, specify Gates Radio Company Model BC-1F Transmitter. All else is on file.

Ordering Information

1000 Watt Broadcast Transmitter complete with one set of tubes, one crystal and oven. State carrier frequency and output impedance when ordering. **Cat. BC-1F-M3250**

1000/500 Watt Broadcast Transmitter complete with one set of tubes, one crystal and oven. State carrier frequency and output impedance when ordering. **Cat. BC-1F-M3410**

Spare crystal and oven. **Cat. JK-57M**

Complete 100% set of tubes for BC-1F transmitter. **Cat. M-3379**

Desk illustrated page 11, less equipment. **Cat. CB-62**

Remote starting panel shown in desk, page 11. **Cat. M-3409**

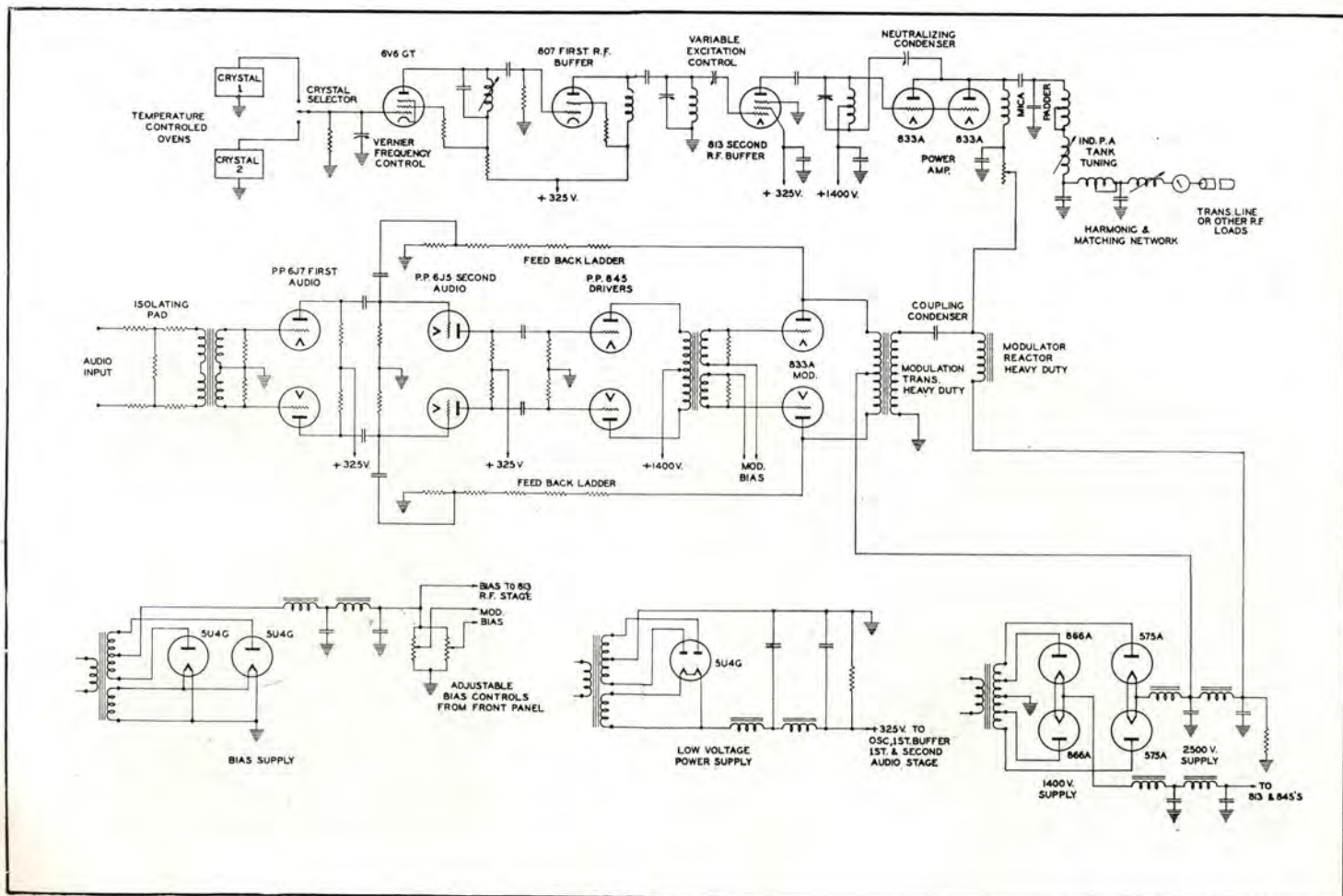

Simplified Schematic BC-1F Transmitter

GATES BC-1F 1000-WATT INSTALLATIONS

Listed below are many radio broadcast stations equipped with the Gates BC-1F air conditioned 1000 watt transmitter. Transmitters sold after January 2, 1953, are not shown nor are numerous government installations. Errors in listing, such as subsequent trade-in for higher power equipment, are unintentional.

WGEM, Quincy, Ill.
 WKRS, Waukegan, Ill.
 WKXY, Sarasota, Fla.
 WTVB, Coldwater, Mich.
 WDKD, Kingstree, S. C.
 WCBA, Corning, N. Y.
 WYVE, Wytheville, Va.
 KERG, Eugene, Oregon.
 WDZ, Decatur, Ill.
 WPEP, Taunton, Mass.
 WKVA, Lewistown, Pa.
 WCOJ, Coatesville, Pa.
 KTRM, Beaumont, Texas.
 CKVL, Verdun, Quebec, Canada
 KGWA, Enid, Okla.
 WNAH, Nashville, Tenn.
 WJAT, Swainsboro, Ga.
 KNED, McAlester, Okla.
 KCRV, Caruthersville, Mo.
 KMAN, Manhattan, Kansas.
 CJSO, Sorel, Quebec, Canada.
 KTOE, Mankato, Minn.
 WFVG, Fuquay Springs, N. C.
 KPBM, Carlsbad, N. M.
 WMPM, Smithfield, N. C.
 WATC, Gaylord, Mich.
 WOPT, Oswego, N. Y.
 WLIL, Lenoir City, Tenn.
 KBKH, Pullman, Wash.
 KTYL, Mesa, Ariz.
 WKCT, Bowling Green, Ky.
 WTOB, Winston-Salem, N. C.
 WIAM, Williamston, N. C.
 KIUP, Durango, Colo.
 KPOC, Pochontas, Ark.
 WTI, Mayaguez, Puerto Rico.
 WGCB, Red Lion, Pa.
 WWSW, Pittsburgh, Pa.
 KOKX, Keokuk, Iowa.
 WKAP, Allentown, Pa.
 KGAL, Lebanon, Oregon.
 WRIC, Richlands, Va.
 WRAY, Princeton, Ind.
 KILO, Grand Forks, N. D.

WFHG, Bristol, Va.
 KBOP, Pleasanton, Texas.
 WCTT, Corbin, Ky.
 KSMN, Mason City, Iowa.
 WGSN, Huntington, Long Island, N. Y.
 WCEN, Mt. Pleasant, Mich.
 WLYC, Williamsport, Pa.
 WORD, Spartanburg, S. C.
 WJPR, Greenville, Miss.
 WPAZ, Pottstown, Pa.
 WFUL, Fulton, Ky.
 WLEA, Hornell, N. Y.
 WRAG, Carrollton, Ala.
 WAIN, Columbia, Ky.
 WHJC, Matewan, W. Va.
 CKPB, Victoriaville, Quebec, Canada.
 KOSY, Texarkana, Ark.
 KCNO, Alturas, Calif.
 KWCB, Searcy, Ark.
 KDLM, Detroit Lakes, Minn.
 WTRW, Two Rivers, Wis.
 WCPA, Clearfield, Pa.
 KDAS, Malvern, Ark.
 WOKE, Oak Ridge, Tenn.
 WBUD, Trenton, N. J.
 CFCL, Timmins, Ontario, Canada.
 XEAS, Nuevo Laredo, Mexico.
 WTIM, Taylorville, Ill.
 KGMC, Englewood, Denver, Colo.
 KMMO, Marshall, Mo.
 WBOK, New Orleans, La.
 WAKN, Aiken, S. C.
 WCMY, Ottawa, Ill.
 WALK, Patchogue, Long Island, N. Y.
 WEYE, Sanford, N. C.
 CFRA, Ottawa, Ontario, Canada.
 KWOC, Poplar Bluff, Mo.
 WPAW, Pawtucket, R. I.
 WARL, Arlington, Va.
 WROS, Scottsboro, Ala.

WELC, Welch, W. Va.
 WDEV, Waterbury, Vt.
 WLCS, Baton Rouge, La.
 WKSR, Pulaski, Tenn.
 KPLN, Camden, Ark.
 WCEH, Hawkinsville, Ga.
 KGKO, Dallas, Texas.
 WIMO, Winder, Ga.
 WTCW, Whitesburg, Ky.
 KWHP, Cushing, Okla.
 KWCO, Chickasha, Okla.
 WTRP, LaGrange, Ga.
 KBLO, Hot Springs, Ark.
 KRCH, Hot Springs, Ark.
 WBRN, Big Rapids, Mich.
 KSVP, Artesia, N. M.
 Police Dept., City of Los Angeles.
 KBHS, Hot Springs, Ark.
 WRMA, Montgomery, Ala.
 WPEL, Montrose, Pa.
 KGRN, Grand Island, Neb.
 KVSA, Dermott, Ark.
 KVSP, Lubbock, Texas.
 WMSC, Columbia, S. C.
 WJVB, Jacksonville Beach, Fla.
 WFRA, Franklin, Tenn.
 WBLE, Batesville, Miss.
 WBBO, Forest City, N. C.
 WLSM, Louisville, Miss.
 KDUZ, Hutchinson, Minn.
 Putnam, Conn.
 WCRT, Birmingham, Ala.
 Radio Occidente, Pinar del Rio, Cuba.
 XEKL, Jalapa Ver., Mex.
 YNBH, Managua, Nicaragua.
 Tiburcio Ponce, Morelia, Mich., Mexico.
 Radio Televisora de Tampico, Tampico, Tamps., Mexico.



Indicating the rugged construction of the BC-1F transmitter is this mobile installation of the Armed Forces Korea network mounted in a six ton semi trailer van. Note the transmitter is firmly secured to floor with no snubbing connection to ceiling.

BC-1F TRANSMITTERS ON THE AIR

Radio Station WGEM and WQDI, the AM and FM radio stations in Quincy, Ill.

To the left the BC-1F 1000 watt transmitter, and to the right Gates 3 kw. FM equipment.

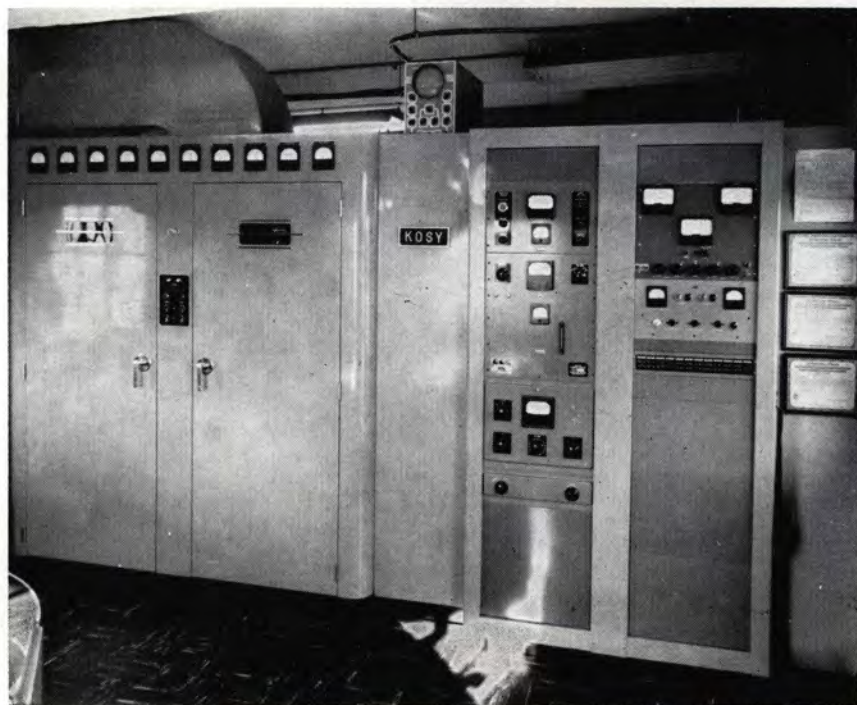
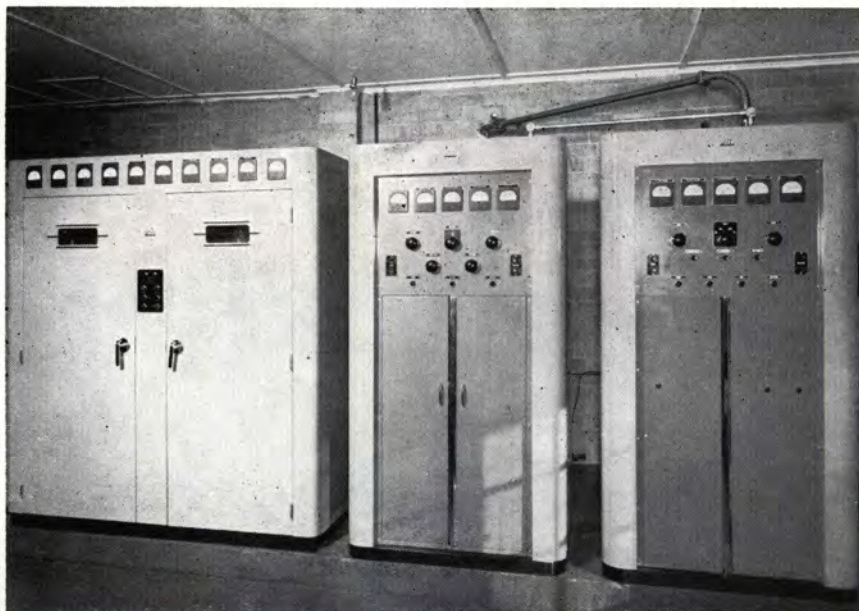

Texarkana, Ark., Texas is represented by this fine installation at KOSY.

Gates BC-1F and MO-3066 accessory rack are shown. Four tower Gates phasor is also part of complete KOSY equipment.

Radio Station WKCT, Bowling Green, Ky., showing BC-1F 1000 watt transmitter, Gates 3 tower phasing equipment and accessory rack with Gates MO-2890 and MO-2639 frequency-modulation monitors.

NOTE: The use of call letters on various completed equipments throughout this catalog is for illustrative purposes only. Where they are identical to assigned call letters it is merely coincidental.



The GY-1000 Packaged Radio Station

(1000 Watts A. M.)

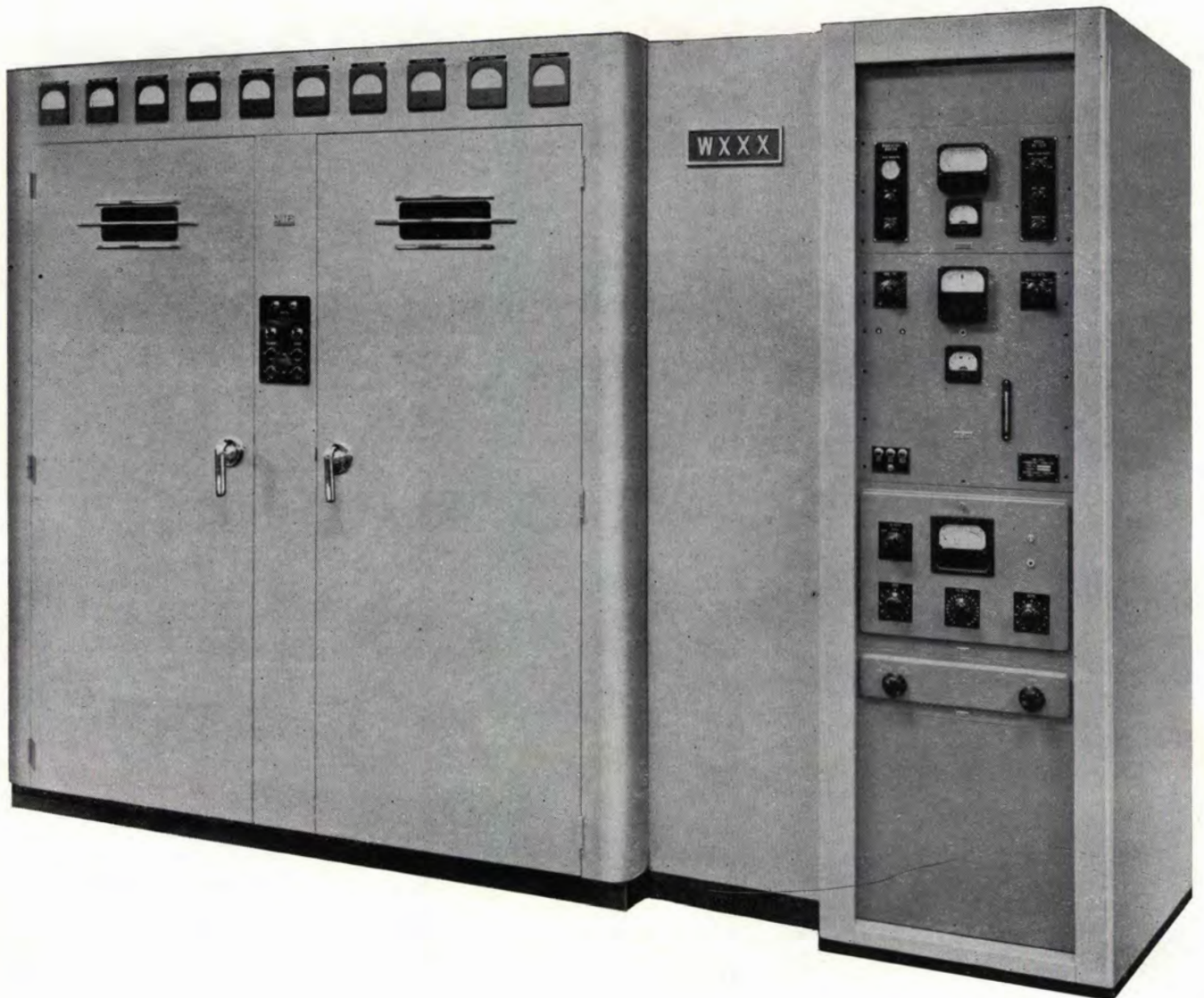

Ready to attach to studio and transmission line, this complete 1000 watt transmitting plant includes all necessary equipment for the transmitter building. It is complete, even to monitoring loud speaker, connecting coaxial cables between monitors and transmitter, call letter plate and styling center panel.

Description GY-1000 Radio Station

There is pride of ownership in a finely styled installation.—Many engineers will be quick to tell you that fine appearance and fine operation go hand in hand. Equally important is that fine appearance is usually only possible in broadcasting through symmetrical location of accessories for best efficiency, both performance and operational-wise.

The GY-1000 radio station is a complete 1000 watt package ready to install quickly and easily. Consisting of the BC-1F 1000 watt transmitter, listed on earlier pages in this catalog, plus the Gates MO-3066 accessory cabinet which contains the Gates MO-2890 frequency monitor, Gates MO-2639 Modulation Monitor, Gates Limiting amplifier of your choice plus input switching and control panel. This, along with complete accessory cabinet wiring, including connecting coaxial cables from monitors to transmitter, assures complete radio station performance and eliminates otherwise often complicated installation problems.

Provided as bonus equipment with the GY-1000 radio station is a 12" monitoring loud speaker which operates directly from the high level output stage in the Gates modulation monitor, thus supplying direct off-the-air monitoring. Call letter plate with your call letters is also provided attached to a styling joiner panel to complete a truly massive and attractive transmitting plant that is second to none.



Ordering Detail

Complete 1000 Watt Radio Station, including BC-1F transmitter, MO-3066 accessory cabinet, joiner panel, call letter plate, monitor speaker, MO-2890 frequency monitor, MO-2639 modulation monitor, SA-38 limiting amplifier, switch panel, blank panels, complete wiring of accessory cabinet, one set of tubes, one crystal and oven. **Cat. GY-1000**

Complete 1000 Watt Radio Station, same as above but including an SA-39 limiting amplifier in place of model SA-38. **Cat. GY-1000A**

For spare transmitter tubes and crystals see page 17. For full detail on monitors and amplifier referred to above, kindly refer to other pages in this catalog (see index). When ordering, state carrier frequency and line impedance. For FCC filing, please file under transmitter, frequency monitor and modulation monitor type numbers which are on file—do not use the package number herein shown.

BC-500GY Broadcast Transmitter

(500 Watts A. M.)

For the exclusive 500 watt broadcaster Gates offers a modern high quality transmitter with roomy, easy to service design and the last word in every engineering detail.

Utilizing a single 833A power amplifier tube high level modulated by 810 tubes, the Gates BC-500GY transmitting plant provides a low cost long life tube complement.

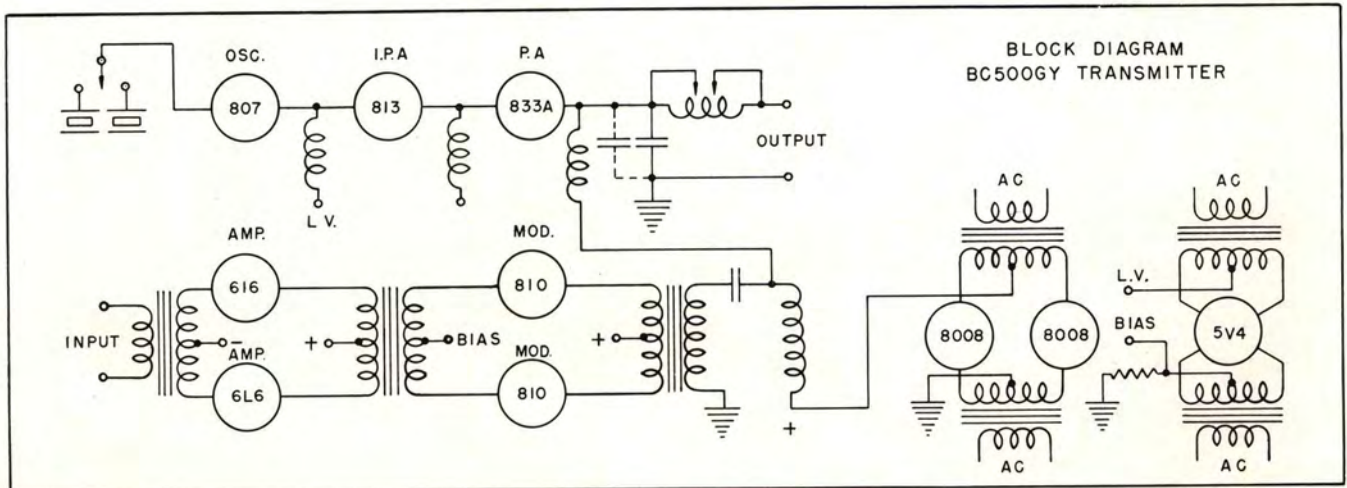

BC-500GY BROADCAST TRANSMITTER

(continued from preceding page)

Many broadcast stations, because of frequency allocations, are granted a maximum power of 500 watts. To make it unnecessary for these grantees to purchase larger equipment at, of course, a greater cost, Gates offers the BC-500GY equipment. Radio frequency section consists of three stages with 807 oscillator, 813 intermediate amplifier and 833A final power amplifier. Output coupling is supplied to match all standard transmission line impedances or may be had for direct coupling to the antenna. Coupling arrangement provides excellent harmonic reduction to meet rigid FCC standards.

Audio system incorporates two push pull stages with a moderate amount of feed-back. It is emphasized

that in this transmitter, as well as all Gates broadcast transmitters, feed-back is an adjunct to improve operation but not necessary to its operation in meeting FCC standards. This assures the purchaser of full sized transformer components not relying on corrective measures as part of the transformer design. Input stage is P.P. 6L6G tubes which feed the class B 810 modulators. Three power supplies provide high voltage to the power stages, low voltage to intermediate stages and bias to the modulators. Relay complement is complete in every detail, as are metering, fusing, balancing controls and all other refinements, that have long been characteristic of Gates equipment in providing plus features for the convenience of the engineer in operation and servicing.

SPECIFICATIONS

TUBES USED—one each 807, 813, 833A and 5V4.. Two each 6L6/6L6G, 810 and 8008.

FCC RATED CARRIER POWER—500 watts.

SYSTEM OF MODULATION—High level class B.

FREQUENCY RANGE—535-1800 Kc. (as specified when ordering).

POWER—230 volts two-wire single phase average consumption 3500 watts.

CARRIER FREQUENCY STABILITY: ± 10 cycles.

R. F. HARMONIC OUTPUT—Below 0.5% when properly adjusted and loaded.

AUDIO INPUT—600 ohms balanced +17 VU. for 100% modulation.

FREQUENCY RESPONSE—Plus or minus 1½ Db. from 30 to 10,000 cycles.

DISTORTION—Less than 3% all frequencies at 95% modulation.

NOISE—60 Db. or better below 90% modulation.

SIZE—78" high, 40" wide, 33" deep.

WEIGHT PACKED—Domestic 1045 lbs. Export 1300 lbs.

OUTPUT IMPEDANCE—40-300 ohms as specified.

METERING—Oscillator plate, I. P. A. plate, P. A. grid, P. A. plate, Filament volts, P. A. volts, Modulator plate, R. F. line output. (Line meter will be 0-3 amperes unless otherwise stated when ordering.)

FCC APPROVAL—On file approved as Model BC-500D.

FINISH—Satin gray hand rubbed with trimmings in chrome and black.

FLOOR WEIGHT—100 lbs. to square foot.

Gates 500 Watt Broadcast Transmitter, complete with one set of tubes, one crystal and oven for coupling to transmission line 40 to 300 ohms. **Cat. BC-500GY**

Gates 500 Watt Broadcast Transmitter, complete with one set of tubes, one crystal and oven for direct coupling to antenna. **Cat. BC-500AGY**

Extra crystal and oven (order to frequency). **Cat. JK57M**

Complete 100% set of tubes for BC-500GY or BC-500AGY transmitter. **Cat. TK-132**

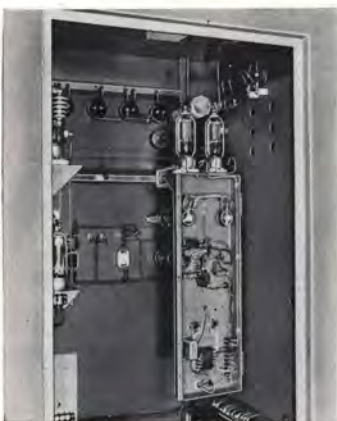

Swing out audio deck shows portion of 100% accessibility of all parts. Every part in the BC-500GY transmitter can be reached in a matter of seconds.



Oscillator unit holds two crystals and ovens and may be removed almost instantly for under chassis servicing.



Rear view illustrates roomy design important in both servicing and low operating temperature. This is Gates walk-in design—average man can stand inside.

GY-50 Packaged Broadcast Station

(For 500 Watts)



Gates pioneered the complete radio station with nothing else to buy. Illustrated above is the complete 500 watt transmitting plant ready to connect to studio and transmission line. Is complete in every detail even to monitoring loud speaker, joiner panel and call letter plate.

Accessory cabinet consists of Gates MO-2639 modulation monitor, MO-2890 frequency monitor, choice of SA-38 or SA-39 limiting amplifier, input switching and audio terminating panel, blank panel, complete wiring of cabinet including coaxial connecting cables from monitors to transmitter. Supplied is a 12" loud speaker which connects to the high level output amplifier in the MO-2639 modulation monitor providing direct off-air monitoring.

SIZE—80¼" wide, 33" deep, 78" high. For FCC filing data use transmitter type number shown on opposite page and monitor type numbers shown above. For additional data on monitors and limiting amplifiers see other pages in this catalog.

Complete GY-50 Radio Station including one set of tubes, one crystal and oven, 12" loud speaker, joiner panel, call letter plate—ready to operate, and with SA-38 Limiting Amplifier. **Cat. GY-50**

Complete Radio Station same as above but with SA-39 Limiting Amplifier instead of Model SA-38. **Cat. GY-50A**



GATES SOUTHWESTERN OFFICE Houston, Texas

This modern stock carrying branch is conveniently located at 2700 Polk Avenue, Houston, Texas, and is ready to serve every need of customers in the great southwest. Staffed by competent executive and engineering personnel, the Houston district office and sales warehouse carries a large stock of not only Gates manufactured equipment, but all necessary items for the broadcast station, whether AM, FM, or TV. Service parts are also available in adequate quantities for all Gates equipment users.

The Houston division is wholly owned by Gates and is part of the nationwide distribution and sales organization provided for broadcasters and other customers to assure fast service on both Gates manufactured products and leading products of other manufacturers which the broadcasting and electronics industry might need.

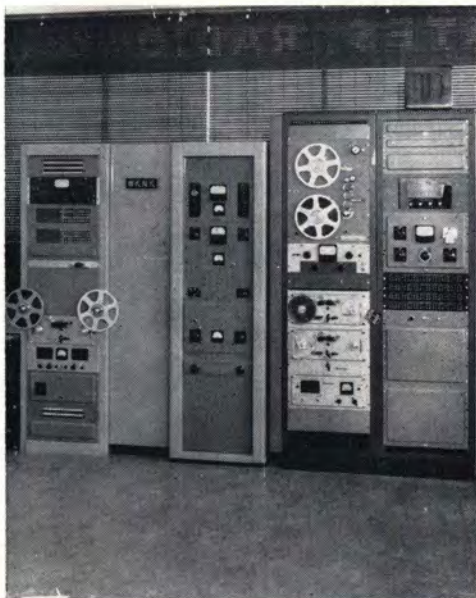

BC-250GY Broadcast Transmitter

(250 Watts A. M.)



Acceptance of the Gates BC-250GY Broadcast Transmitter by more broadcasters than that of any other make, is perhaps the easiest way to say in a few words that this 250 watt transmitting plant is the quality plus work horse of the broadcast industry. Nearly 200 stations around the world are Gates BC-250GY equipped.

BC-250GY BROADCAST TRANSMITTER

We, at Gates, like to feel that the prestige held by the BC-250GY transmitter is because of its unusual quality in workmanship, quality in materials, and most important of all, its unblemished record in being a trouble free day in and day out performer.

BC-250GY is a large massive transmitting plant. By no means has it been designed to fit in the smallest possible space. Instead, its large attractive cabinet contains an assemblage of husky parts properly located for cool easy-to-service operation. Any part, the smallest resistor or largest transformer may be reached in a few seconds. If need be, the engineer can walk inside the cabinet to attend any servicing requirement. In 250 watt transmitting equipment there has never been anything quite so fine. This is endorsed by a large discriminating clientele.

For those who are proud of appearance as well as performance, BC-250GY has multi-kilowatt trans-

mitter styling. Standing 78" high, 40" wide and 33" deep, it is finished in medium satin gray and hand rubbed to a mirror finish. It will clean easily and always retain the new look so important to engineers who take pride in their equipment. A full size back door not only assures quick and easy accessibility but initial ease in installation. Convex cooling is a natural in the roomy design and the absence of a blower or fan means silent operation and use in the same locality as a live microphone.

Electrically, BC-250GY is straightforward design. Though moderate feed back is employed the transmitter will meet full FCC requirements with feed back removed. This means that audio components are full size and feed back is never employed as a cost saver but instead to still further improve the air quality. There are 3 radio frequency stages which are modulated high level by two push pull audio stages. Two power supplies provide high and intermediate voltages. Metering is complete with

. . . . continued on page 28



This Gates 250 watt transmitting plant is definitely big transmitter design. The alert eye will note edgewise tank coil construction, fully cased transformers and remarkable accessibility.

BC-250GY BROADCAST TRANSMITTER

(continued from preceding page)

seven 3" square case meters on the front plus a 2" meter located directly on the oscillator unit for easy tune up.

The audio section is hinged only for the purpose of quick servicing and reaching any part, no matter how dependable, in seconds (see illustration at bottom of page). The oscillator unit (illustrated at bottom of page) is quickly removable if need be. Provision is made for two accurate temperature controlled ovens, each of which accommodates the crystal ground to the purchaser's exact operating frequency. Changing ovens is by means of a toggle switch located on the oscillator. Crystal ovens are of the non-thermometer type eliminating an otherwise time consuming logging operation and yet meeting full FCC requirements.

Relay and protective equipment includes overload relays for both the radio frequency and modulator sections, complete primary and sub primary fusing and vacuum type time delay relay. The output coupling network is an L network with both variable capacitor and tapped coil design so that coupling to any load between 30 and 300 ohms is possible. For other coupling arrangements, such as direct to a low resistance antenna or shunt fed antenna, the BC-250GY transmitter can be supplied at only slight added cost. Radio frequency line meter is standard equipment. All major power resistors are of the ferrule type, instantly replaceable without the use of a soldering iron. Power resistors are all substantially larger than the demands from them to assure conservative trouble free operation.

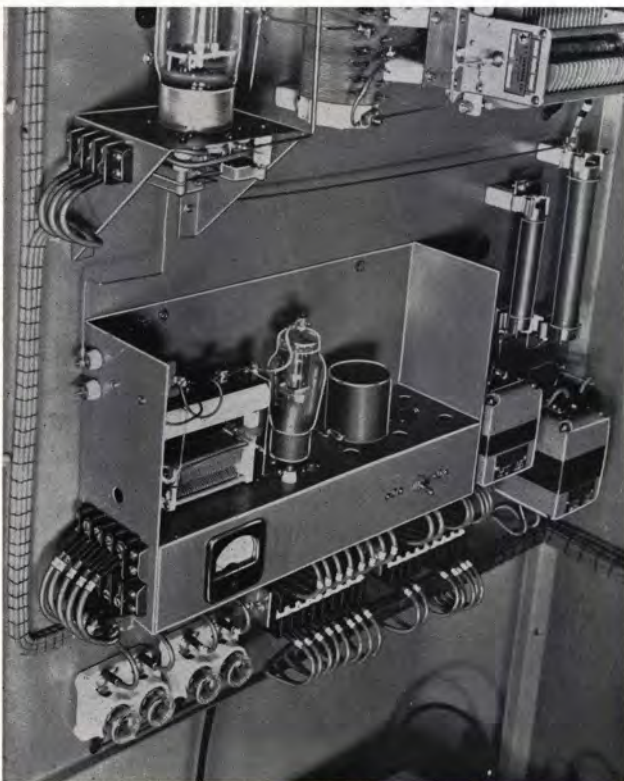

Oscillator unit allows for use of two non-thermometer type plug in crystal ovens and may be removed in a few seconds for servicing if required.

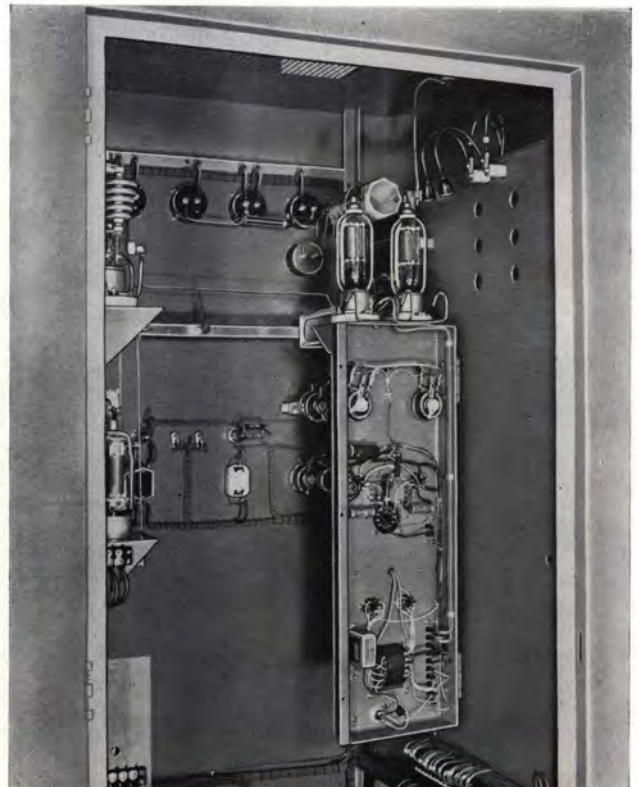

Above illustrates hinged audio deck to complete the almost instant availability of the most minute part, no matter where it is located in the transmitter.

Technical Data BC-250GY Transmitter

TUBES USED—807 oscillator, 813 intermediate amplifier, two 810 power amplifiers, two 810 modulators, two 6L6 (1622) audio drivers, two 8008 rectifiers, one 5V46 bias rectifier.

FCC RATED CARRIER POWER—250 watts.

SYSTEM OF MODULATION—High level class B.

FREQUENCY RANGE—550-1800 Kc. (as specified when ordering).

POWER (Line)—230 volts 50/60 cycles single phase.

POWER (Consumption)—1.6 Kw.

FREQUENCY STABILITY—Plus or minus 10 cycles.

RADIO FREQUENCY HARMONICS—Below .05% (when properly loaded).

AUDIO INPUT—600 ohms, plus 14 V. U. for 100% modulation.

FREQUENCY RESPONSE—Plus or minus 1½ Db., 30-10,000 cycles.

DISTORTION—Not exceeding 2.9% from 50-7500 cycles.

NOISE—60 Db. or better below 95% modulation.

SIZE (Transmitter only)—78 inches high, 40 inches wide, 33 inches deep.

WEIGHT PACKED—Approximately 900 lbs.

ANTENNA LOADING—As supplied 30 to 300 ohms (others where specified).

Note—Unless otherwise stated, line meter will be supplied for 0-3 amperes.

Ordering Detail

Complete 250 Watt Transmitter with one set of tubes, one crystal and oven, for any output from 30 to 300 ohms. Specify operating frequency and line impedance when ordering.
Cat. BC-250GY

Complete 250 Watt Transmitter, same as above but for direct coupling to shunt or series fed antenna. Give full antenna data when ordering.
Cat. BC-250GYA

100% extra set of tubes for BC-250GY Transmitter. **Cat. M-3074**

Extra crystal and oven for above **Cat. JK57M**

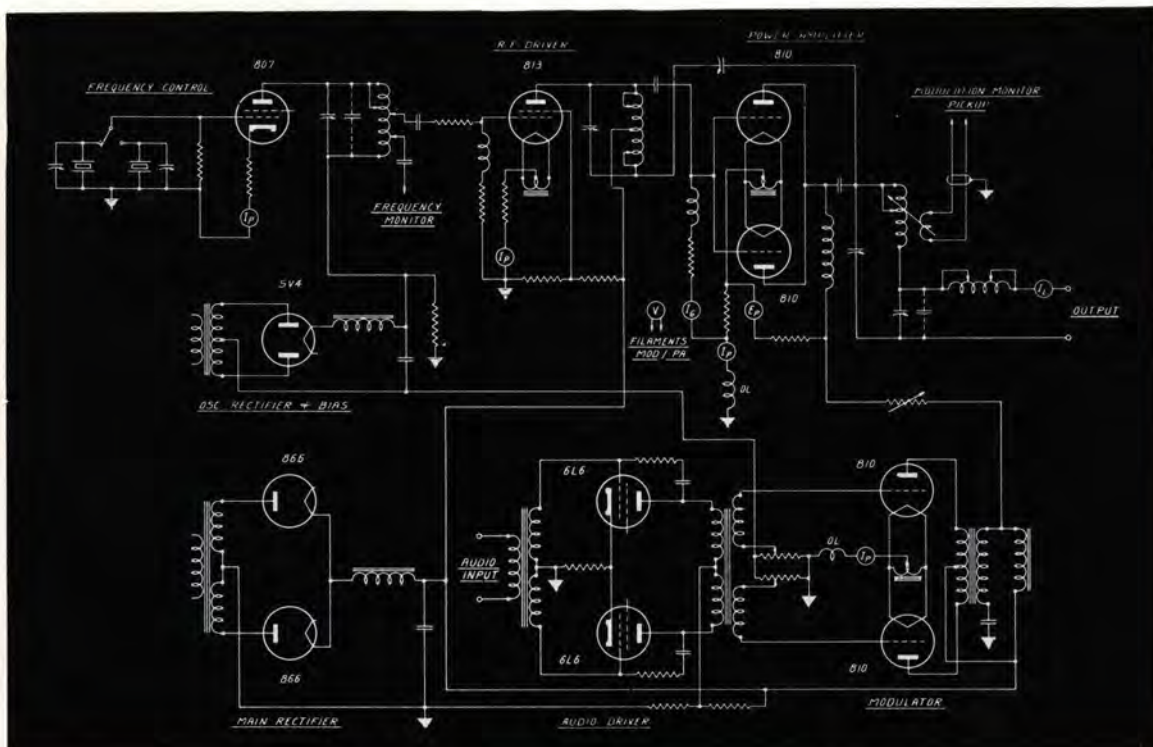

Simplified Schematic BC-250GY Transmitter

USERS OF BC-250GY TRANSMITTERS OR GY-48 RADIO STATIONS

WFAX, Falls Church, Va.
 WGYV, Greenville, Ala.
 WBBQ, Augusta, Ga.
 WMRA, Myrtle Beach, S. C.
 WBBZ, Ponca City, Okla.
 WMDN, Midland, Mich.
 WSPT, Stevens Point, Wis.
 WJMW, Athens, Ala.
 KRTN, Raton, N. M.
 WKID, Urbana, Ill.
 WIDE, Biddeford, Maine.
 KMUR, Murray, Utah.
 WKBS, Oyster Bay, N. Y.
 KTRF, Thief River Falls, Minn.
 WCVB, Culpeper, Va.
 KNEX, McPherson, Kansas.
 KCOW, Alliance, Neb.
 WHAR, Clarksburg, W. Va.
 WNOR, Norfolk, Va.
 KLMX, Clayton, N. M.
 WEAB, Greer, S. C.
 WNNT, Warsaw, Va.
 KICK, Springfield, Mo.
 WSDR, Sterling, Ill.
 KNEM, Nevada, Mo.
 KOFO, Ottawa, Kansas.
 KCNI, Broken Bow, Neb.
 KIFN, Phoenix, Ariz.
 KTKT, Tuscon, Ariz.
 WBLT, Bedford, Va.
 KLMO, Longmont, Colo.
 WCDL, Carbondale, Pa.
 KAFP, Petaluma, Calif.
 KDIA, Auburn, Calif.

WIRY, Plattsburg, N. Y.
 KENM, Portales, N. M.
 WPKY, Princeton, Ky.
 WTTN, Watertown, Wis.
 KLIZ, Brainerd, Minn.
 KCHI, Chillicothe, Mo.
 WJEH, Gallipolis, Ohio.
 KOLS, Pryor, Okla.
 WCLI, Corning, N. Y.
 WPNF, Brevard, N. C.
 WATW, Ashland, Wis.
 WKBI, St. Marys, Pa.
 KALG, Alamogordo, N. M.
 WACR, Columbus, Miss.
 WVSC, Somerset, Pa.
 KJAN, Atlantic, Iowa.
 WBIP, Booneville, Miss.
 WJQS, Jackson, Miss.
 KRXL, Roseburg, Oregon.
 KRMO, Monett, Mo.
 WBNL, Boonville, Ind.
 WSOY, Decatur, Ill.
 WAKE, Greenville, S. C.
 KSEY, Seymour, Texas.
 KSAM, Huntsville, Texas.
 KTER, Terrell, Texas.
 WLCK, Campbellsville, Ky.
 WNLC, New London, Conn.
 KRXX, Rexburg, Idaho.
 KFIR, North Bend, Oregon.
 KPAT, Pampa, Texas.
 KFLD, Floydada, Texas.
 WOKW, Sturgeon Bay, Wis.
 KFST, Ft. Stockton, Texas.

WMTE, Manistee, Mich.
 KGMO, Cape Girardeau, Mo.
 WAVA, Ava, Ill.
 WJET, Erie, Pa.
 KPUY, Puyallup, Wash.
 WABA, Aquadilla, Puerto Rico.
 KWTN, Crystal City, Texas.
 WMPA, Aberdeen, Miss.
 KDMA, Montevideo, Minn.
 WCMC, Wildwood, N. J.
 WIRO, Ironton, Ohio.
 WPAC, Patchogue, N. Y.
 KRAI, Craig, Colo.
 WMLT, Dublin, Ga.
 WABJ, Adrian, Mich.
 WINL, Hammond, La.
 WEVA, Emporia, Va.
 KWLC, Decorah, Iowa.
 WJFR, Caguas, Puerto Rico.
 WEPM, Martinsburg, W. Va.
 WIKE, Newport, Vt.
 WDHL, Bradentown, Fla.
 KBWL, Blackwell, Okla.
 WMAW, Menominee, Mich.
 KNIM, Maryville, Mo.
 KVOM, Morrilton, Ark.
 WWSC, Glen Falls, N. Y.
 WNOR, Petersburg, Va.
 KREH, Oakdale, La.
 CMCI, Havana, Cuba.
 Alejandro Diaz, Guadalajara,
 Mexico.

NOTE—Above listing through December 31, 1952. Omissions are unintentional. For obvious reasons military installations cannot be shown but are substantial around the world. Also foreign installations not shown due to difficulty in obtaining call letters.



Complete GY-48 Radio Station with Gates Speech Equipment at Radio State KPAT, Pampa, Texas. Note massive appearance and excellent combination type installation.

The GY-48 Packaged Radio Station

(250 Watts A. M.)



For the new radio station or the long established broadcaster purchasing all new equipment, the co-ordinated design of the entire transmitting plant assures positive results, lower installation cost, much better appearance and that every part and accessory fits electrically. The Gates GY-48 Radio Station has all necessary equipment for the 250 watt transmitting plant, ready to attach to studio and transmission line. GY-48 is your assurance you have forgotten nothing and that you have ordered the correct material.

... continued next page

DESCRIPTION GY-48 RADIO STATION

Gates was first to provide broadcasters with a packaged radio broadcast plant.—Since the original announcement, scores of the GY-48 radio stations have been sold and are daily satisfying discriminating engineers everywhere. — The BC-250GY transmitter is fully described starting on page 26. To this is added the MO-3066 accessory cabinet which is entirely wired and contains Gates MO-2890 Frequency Monitor, Gates MO-2639 Modulation Monitor, Gates Limiting amplifier and Switching panel to handle two input circuits from the studios and to switch the Limiter in and out of the circuit in case of tube replacement. — Connecting coaxial cables between transmitter and both monitors are supplied with plugs attached. As bonus equipment a styling joiner panel with your call letters on a cast aluminum plate along with 12" monitor loud speaker is supplied. Overall size 80 $\frac{1}{4}$ " wide, 78" high and 33" deep.

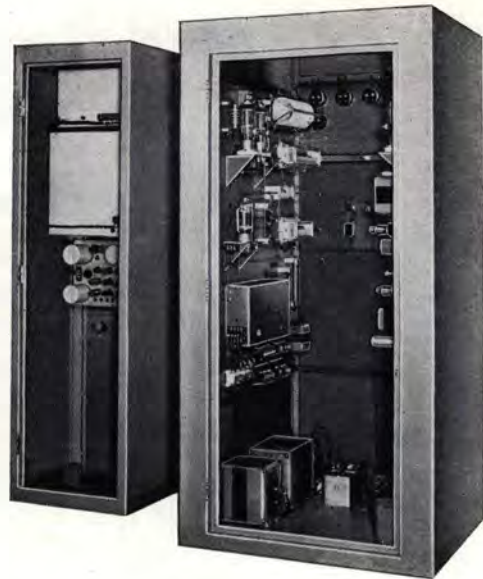

Ordering Detail

Complete 250 Watt Radio Station includes BC-250GY transmitter, MO-3066 accessory cabinet with MO-2890 Frequency Monitor, MO-2639 Modulation Monitor, SA-38 Limiting amplifier, switching panel, complete wiring, joiner panel, call letter plate, loud speaker and connecting coaxial cables from transmitter to monitors, with one set of tubes, one crystal and oven.

Cat. GY-48

Complete 250 Watt Radio Station same as above only Model SA-39 Limiter supplied in place of Model SA-38.

Cat. GY-48A

For complete description of accessory items such as monitors and amplifiers, see other pages in this catalog (refer to index). For spare transmitter tubes and crystal see Page 29. Loud speaker and call letter plate with joiner panel are bonus items and not supplied when GY-48 ordered other than complete. For FCC filing, use transmitter and monitor type numbers and not package number shown herein.

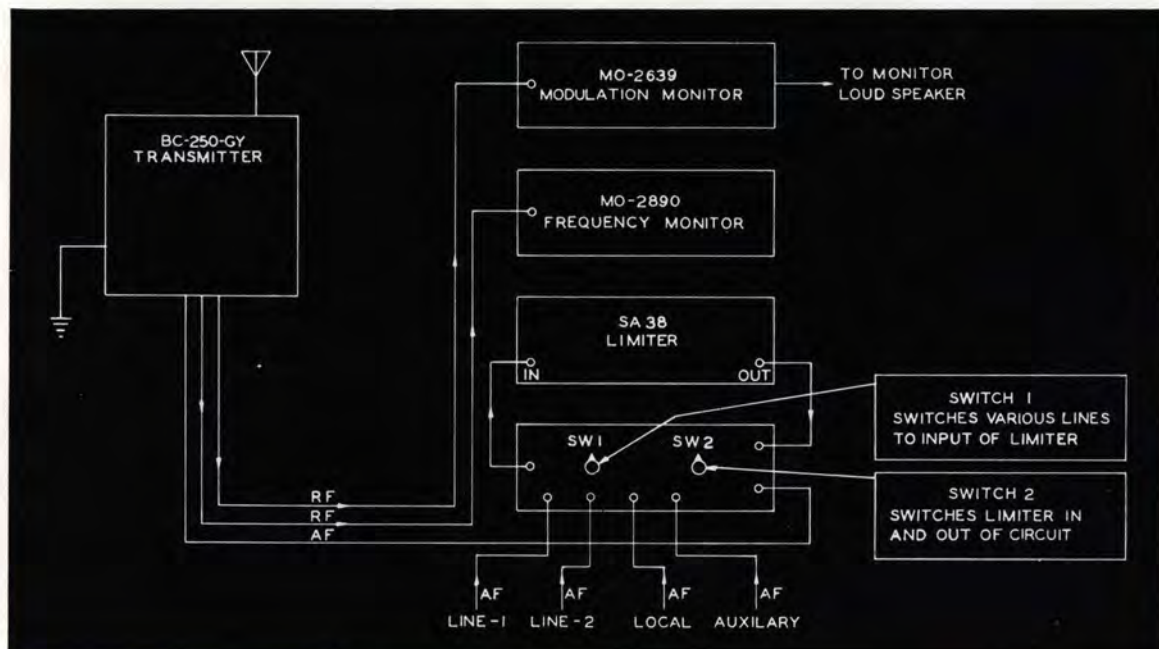

Block Diagram GY-48 Radio Station

BCA-250 Auxiliary Transmitter



Gates engineers were asked to design, along economical lines, an excellently performing 250 watt transmitter that could be used for standby or auxiliary purposes. In the BCA-250 transmitter the broadcaster may purchase not only an excellent transmitter but peace of mind, as well. No longer need the failure of the main transmitter mean time lost. The modest selling price, much lower than you might think, will, in very many instances, be recouped in advertising revenues otherwise lost during only one main transmitter outage.

Standby transmitters need not meet the same FCC specifications as the main transmitting plant. This results in a substantial saving; and yet, excellent transmission quality and complete reliability are maintained. It is our belief that every broadcasting station, regardless of power, will, because of this new low cost standby equipment, want to seriously consider the Gates BCA-250 transmitting equipment.

BCA-250 AUXILIARY TRANSMITTER

If the meters drop to zero on your No. 1 transmitter, make Gates BCA-250 your No. 2 standby. Switch the audio input and line output and you are back on the air with only seconds lost. You can then make repairs on No. 1, taking your time, keeping advertisers and listeners happy. Power failure protection means expensive standby generators for higher powered installations, while a small and inexpensive power plant will operate the BCA-250 transmitter and give you double standby protection.

Radio frequency portion has three stages with parallel 812A tubes in the output feeding into a pi-network to match standard transmission line impedances. Broadcast tolerances for frequency drift are maintained with a temperature controlled oven. Frequency and modulation monitor connections are provided. Audio system accommodates either 600 ohm line or low level high impedance microphone, the latter desirable in case of failure of both main transmitter and studio telephone line or studio power. Modulators are P.P. 811A Class B.

SPECIFICATIONS

- FREQUENCY RANGE**—530 to 2000 kc.
- POWER REQUIREMENTS**—115 volts, 60 cycles, 1100 watts.
- FREQUENCY STABILITY**— ± 10 cycles.
- A. F. INPUTS**—600 ohms at +10 db and Hi-Z for low level microphone.
- RESPONSE**— ± 2 db, 100-5000 cycles.
- DISTORTION**—5% or less, 100-5000 cycles.
- NOISE**—50 db below 95% modulation.
- OUTPUT IMPEDANCE**—For 50, 70 or 250 ohms (as ordered).
- SIZE**—50" high, 23" wide, 26" deep. Full size back door, finish gray.
- WEIGHT**—Approximately 600 lbs.
- TUBES**—6AG7 osc., 6146 int. amp., (2) 812A power amps., 6SJ7 mic. amp., 6L6/6L6G amp., (2) 811A modulators, (2) 866/866A rectifiers, (2) 5U4G rectifiers. Also selenium rectifier and vacuum type time delay tube supplied.

The BCA-250 transmitter is offered for auxiliary service only and will be licensed only as such by the Federal Communications Commission. For foreign usage, regulations applicable in the country of usage will apply.

Auxiliary Transmitter with one set of tubes.
Crystal and oven for above (order to frequency).

Cat. BCA-250
Cat. JK-57

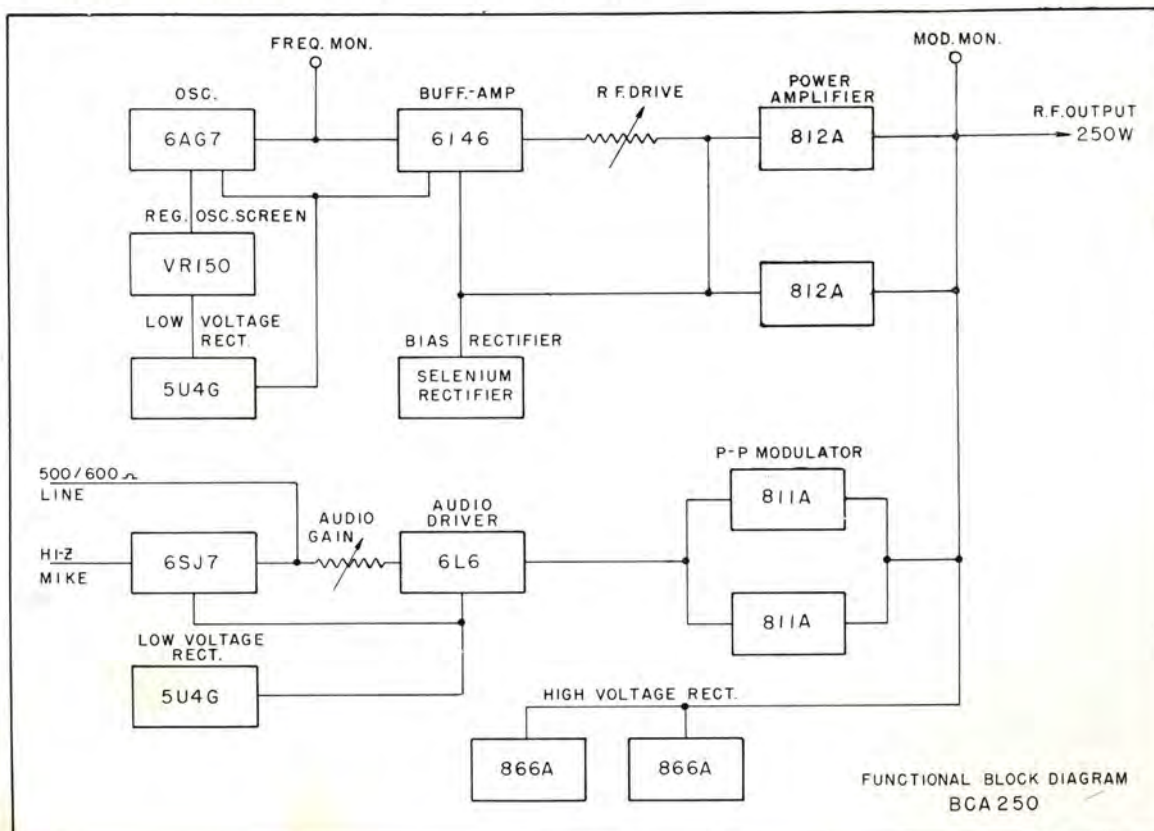

FM BROADCAST OR COMMUNICATIONS TRANSMITTER

(250 Watts)

A new Gates 40-216 mc transmitter for use in either broadcast or communications and at powers up to 250 watts. Ideal for:

- FM BROADCASTING
- POINT TO POINT
- RELAY SERVICE
- GROUND-AIR COMMUNICATIONS

or

any service where top FM performance between 40 and 216 mc is required.

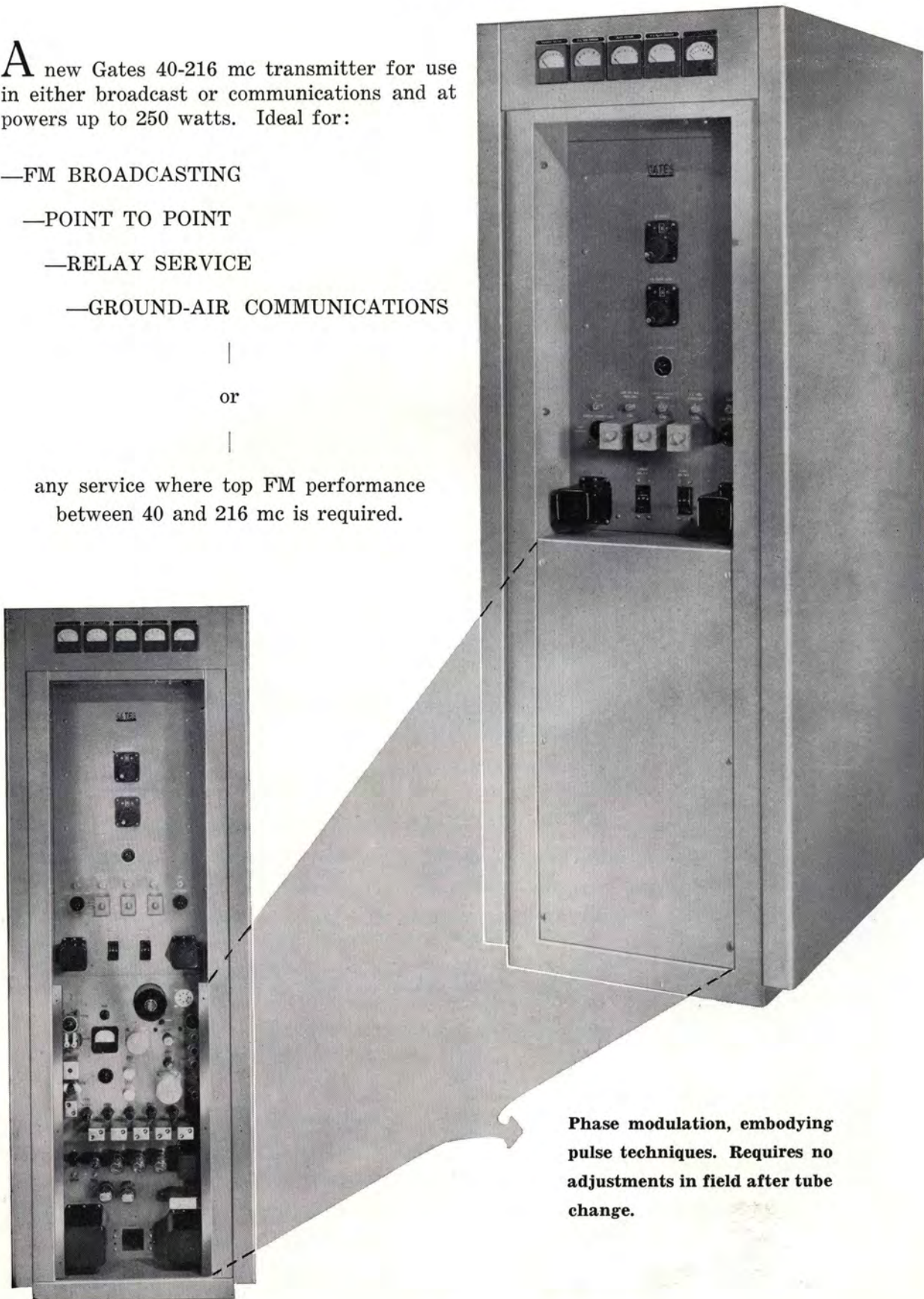

Phase modulation, embodying pulse techniques. Requires no adjustments in field after tube change.

FM BROADCAST OR COMMUNICATIONS TRANSMITTER

(250 Watts)

The FMR-250 transmitter is designed for rugged service as expected either in continuous communications or broadcasting service, yet its price remains reasonable by reason of advanced and simplified design which greatly reduces tube cost as well as complicated circuit components. This results in a transmitter easy to keep on the air and at top quality performance every minute of air time.

Transmitter may be operated at varying powers from 100 to 250 watts, as desired. Low voltage power supply is of regulated type to assure consistency in stability. Line voltage correcting switch on front panel allows quick correction for sagging or excessive primary voltage. Complete blower air circulation with filtered intake allows for abusive tropical operation. Automatic overload protection is elaborate in every detail. Such refinements as built-in cabinet service light and service outlet, plus almost instant accessibility of all parts, will please the discriminating engineer.

SPECIFICATIONS

POWER OUTPUT—100-250 watts (full 250 watts on all frequencies available).

FREQUENCY COVERAGE—40 - 216 mc (as specified).

MODULATION—FM with ± 75 kc swing maximum.

DISTORTION—1.5% maximum at ± 75 kc swing for any frequency between 50 and 15,000 cycles.

NOISE (FM)—60 db below ± 75 kc swing.

NOISE (AM)—55 db below 100%.

FREQUENCY RESPONSE— ± 1 db between 50 and 15,000 cycles (can cut off as desired for communications service).

AUDIO INPUT IMPEDANCE—600 ohms nominal (available with 150 ohm input impedance).

AUDIO INPUT LEVEL— +10 dbm.

PRE-EMPHASIS—(Separate plug-in 75 microsecond pad when requested).

OUTPUT IMPEDANCE—51 ohms, with type N fitting.

IMPEDANCE MONITOR—(Power output meter reading directly in watts and standing wave ratio built-in as an integral part of the transmitter.)

POWER INPUT—105 to 125 volts, 50/60 cycles, single phase, two-wire. Other voltages and frequency on special order.

METHOD OF MODULATION — Phase, employing pulse techniques which do not require adjustment in the field or when tubes are changed.

TUBES — 5	6SJ7	1	6SH7
1	6AG7	2	5U4G
1	6SN7	2	866A
1	6V6	2	4X150A
1	815	2	12AY7
1	829B	1	12AX7
3	6AS7	1	6BA6
1	VR105		

FREQUENCY STABILITY— $\pm .001\%$.

WEIGHT—715 pounds net. 1005 pounds packed.

CABINET SIZE—27½" wide, 36" deep, 78" high. Finish—gray.

250 Watt FM Transmitter with tubes, crystal and oven.

Cat. FMR-250

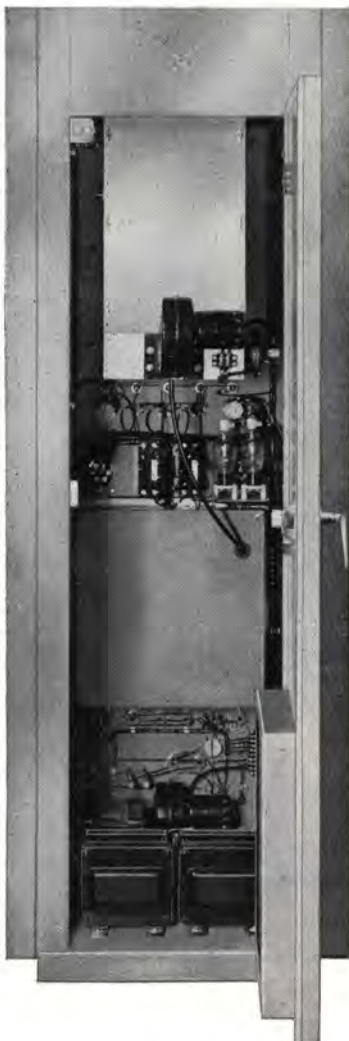

REAR—FMR-250
Transmitter

Low Power FM Transmitter

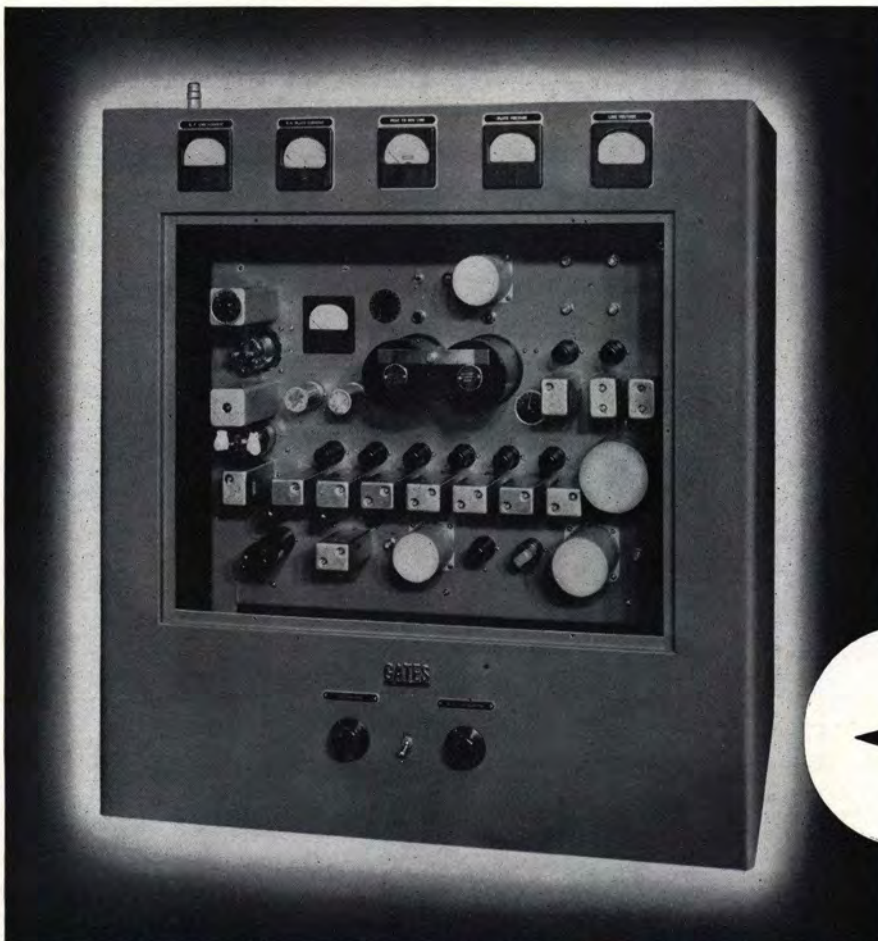

For educational FM broadcasting plus a model in the 150 mc band.

EDUCATIONAL BROADCASTING in the FM broadcast band is permitted at a power of ten watts for any educational institution that is non-commercial in scope, i. e., does not operate commercially for profit. This qualifies nearly all public schools, colleges and universities for this type of service. The Gates BF-E-10 transmitter has been designed with this service in mind. Nothing else is required to complete the transmitting portion of the installation other than antenna. Gates engineers will gladly assist any educational institution in planning an FM broadcasting station.

REMOTE AND RELAY service in the 150 mc band, utilizing directional or non-directional antennas, is excellently handled by the BF-R-10 transmitter. Design in this case is for 115-170 mc. Having full audio range up to 15,000 cycles, it may be used for very high quality transmission and under continuous duty conditions. The size also lends itself to station wagon or small truck installation for mobile remote pickup service.

LOW POWER FM TRANSMITTER

Available in two types. The BF-E-10 for 88-108 mc service, which is the FM broadcast band and used in part for educational broadcasting, and the BF-R-10 for any frequency (as ordered) between 115 and 170 mc. Both types are the same other than tank coil design.

The transmitter is constructed in a steel cabinet, finished in gray, 36" high, 34" wide and 24" deep. The standard FM exciter unit employed in scores of Gates FM transmitters of all powers, with the output tube an 829B, provides as much as 15 watts at 108 mc and a full 10 watts at 170 mc. Output is 51 ohms to match standard RG type coaxial cable. Metering is complete, six meters in all, reading: plate current, plate voltage, line voltage, relative power output and modulation indicator. A sixth meter, located directly on the exciter, is a multi-meter switchable into all pertinent metering circuits for tuning and adjustment. Controls are to a minimum, consisting of a power line voltage control, off-on switch and power output control. Modulation is phase shift, permitting direct crystal control of the oscillator. Provision is made for two crystals and ovens. One is supplied.

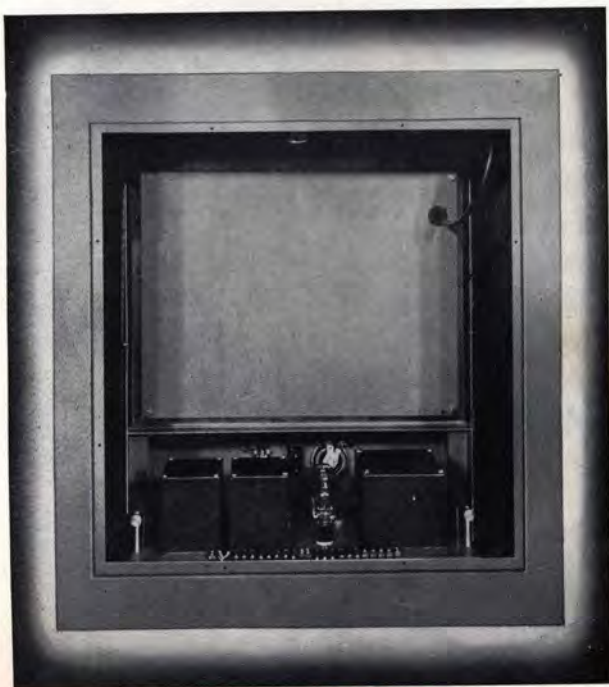

Rear view of the BF-E-10 transmitter shows the power supply in the bottom and the transmitter portion just above. The inside cover over the transmitter chassis is easily taken off by removing the four thumb screws in the corners and disconnecting the coaxial output feed line at the fitting on top of the transmitter.

SPECIFICATIONS

POWER OUTPUT—10 watts nominal rating.
FREQUENCY RANGE—88 to 108 megacycles.
R. F. OUTPUT IMPEDANCE—40-80 ohms.
TYPE OF OSCILLATOR—Direct crystal control.
FREQUENCY STABILITY—Plus or minus 500 cycles.
TYPE OF MODULATION—Phase shift.
MODULATION CAPABILITY—100 kilocycles.
AUDIO INPUT IMPEDANCE—600 ohms.
AUDIO INPUT LEVEL—Approximately +10 decibels.
FREQUENCY RESPONSE—Within 1½ db of standard 75 microsecond pre-emphasis curve.
DISTORTION—Less than 1½% 50-100 cycles; less than 1% 100 cycles to 15,000 cycles.
TUBE COMPLEMENT—Two type 5Z3, nine type 6SJ7, one type 6SN7, one type 6V6 (metal), one type 815, one type 829B, one type 5593 G. E.
POWER INPUT—165 watts, approximately.
POWER SOURCE—115 volts, 60 cycle, single phase.
DIMENSIONS—36" high, 34" wide, 24" deep.
Approximately 31 cu. ft. boxed for export shipment.
WEIGHT—Net approximately 225 lbs.
Gross packed for export, approximately 300 lbs.

FM transmitter, one set of tubes, one crystal and oven, for 88-108 mc. **Cat. BF-E-10**

FM transmitter, one set of tubes, one crystal and oven, for 115-170 mc. **Cat. BF-R-10**

FM-11 ANTENNA

A single bay, broad band antenna, designed to operate at any frequency between 88-95 mc or in the educational FM broadcast band. Designed to match to a 2½" steel pipe. Power gain 0.8. An excellent low cost antenna, easy to install. RG-11U coaxial cable is suggested to connect between BF-E-10 transmitter and the FM-11 antenna.

Broad band FM antenna.

Cat. FM-11



FM-11 broad band antenna, above, requires no tuning. Mast illustrates method of mounting but is not supplied.

MO-2890 AM Frequency Monitor

(FCC Approval No. 1469)

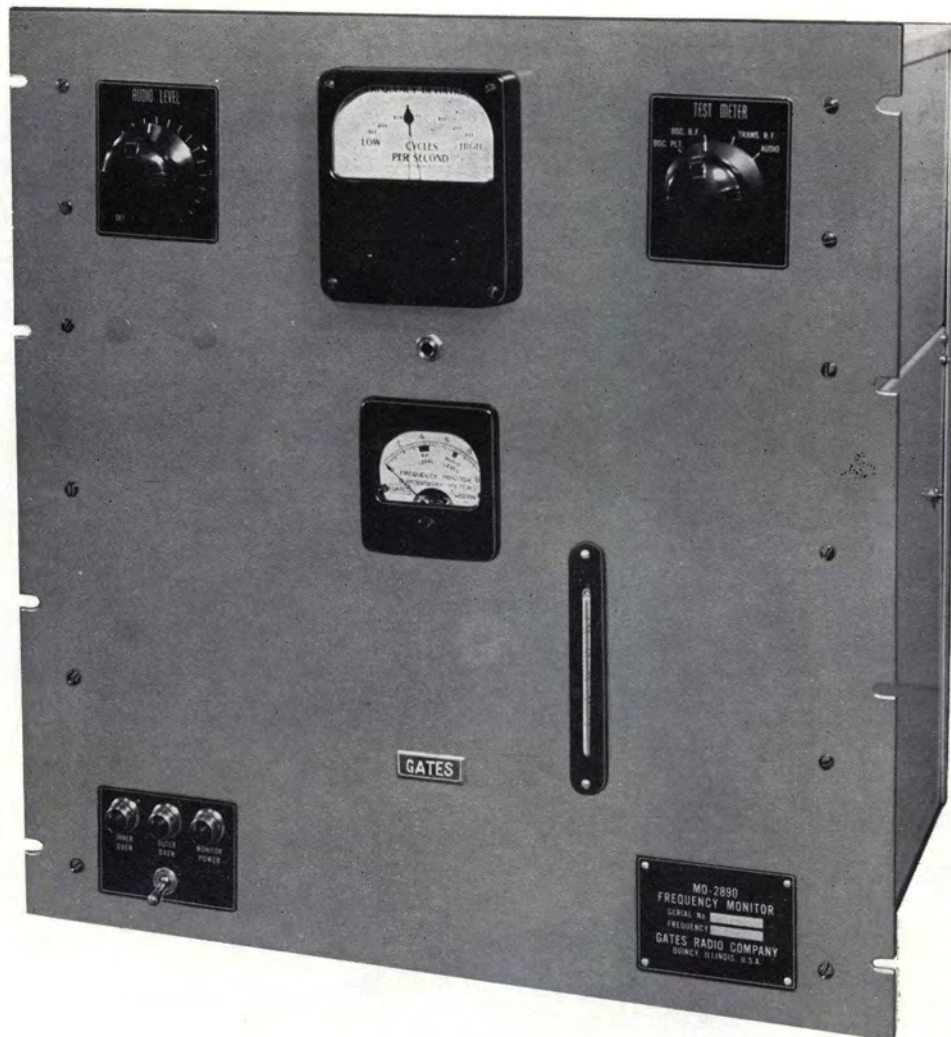

This modern Frequency Monitor, with a proven service record, is used by hundreds of broadcast stations. Ruggedly constructed and carefully tested to assure accuracy of better than five parts in a million. Fully FCC approved.

MO-2890 FREQUENCY MONITOR

For positive measurement of the frequency drift of your broadcast transmitter, the Gates MO-2890 Frequency Monitor has proven itself in daily operation in America's finest radio stations. Straight-forward circuitry combined with an unusual dual oven design relieves the operator of worries both in performance and servicing requirements.

A precision crystal oscillator, operating 500 cycles below the transmitter frequency, has the output amplified by one stage and then mixed into a detector stage with a small amount of the radio frequency signal from the transmitter. The resulting beat note of 500 cycles when the transmitter is on frequency is further amplified and then applied to the frequency meter. This meter is calibrated from -30 to +30 cycles with zero point at center scale, which corresponds to 500 cycles. Meter is calibrated in one cycle steps. A phone jack is also provided for aural monitoring.

The smaller meter just below the frequency meter indicates the amount of R. F. signal fed into the monitor. This same meter also indicates oscillator current, oscillator signal voltage and signal voltage from transmitter.

Two ovens, one located inside the other, carefully guard the accuracy. The inside oven is controlled by a mercury column thermostat operating at temperature variations of 0.2°, with the crystal located in this oven. The outer oven operates at slightly lower temperature—operates also at close temperature tolerance and accommodates the tube and oscillator components.

Front panel equipment includes the two meters previously referred to, oven indicating pilot lamps, off-on switch with pilot lamp, input signal adjusting control and meter selector switch. All connections and adjustments are easy to make. Openings in the dust cover allows access to variable capacitor adjustment, fuses and terminal block.

SPECIFICATIONS

OSCILLATOR ACCURACY—Better than 5 parts per million.

FREQUENCY METER CALIBRATION—Minus 30 to plus 30 with zero at center scale. Calibration marks are at one cycle intervals allowing deviation of less than one cycle to be observed.

TUBE COMPLEMENT—Oscillator 6AC7, RF Amplifier, 6SJ7, Current Detector 6H6, Mixer 6C5, Audio Amplifier 6SJ7, Audio Output 6V6, Rectifier 5U4G, Voltage Regulator VR150-30.

RF DRIVING POWER—5 watts maximum.

DIMENSIONS—19¼" panel space on 19" standard rack cabinet. Depth 12".
Packed for export 15½ cu. ft.

WEIGHT—85 lbs. net, 125 lbs. gross.

POWER REQUIREMENTS—85 watts.

POWER SOURCE—115 volts 50/60 cycles.

FCC APPROVAL NUMBER—1469.

Complete Frequency Monitor, with one set of tubes.

Cat. MO-2890



The rear view of the MO-2890 Frequency Monitor with the dust cover in place. It is held in place by patented fasteners which allow removal by a quarter turn of a screwdriver or coin.

With dust cover off, as shown above, all components in the MO-2890 are easy to reach. The inner and outer ovens (lower left above) are shown with their covers removed and in the center illustration as they look when in place.

MO-2639 AM Modulation Monitor

(FCC Approval No. 1556)

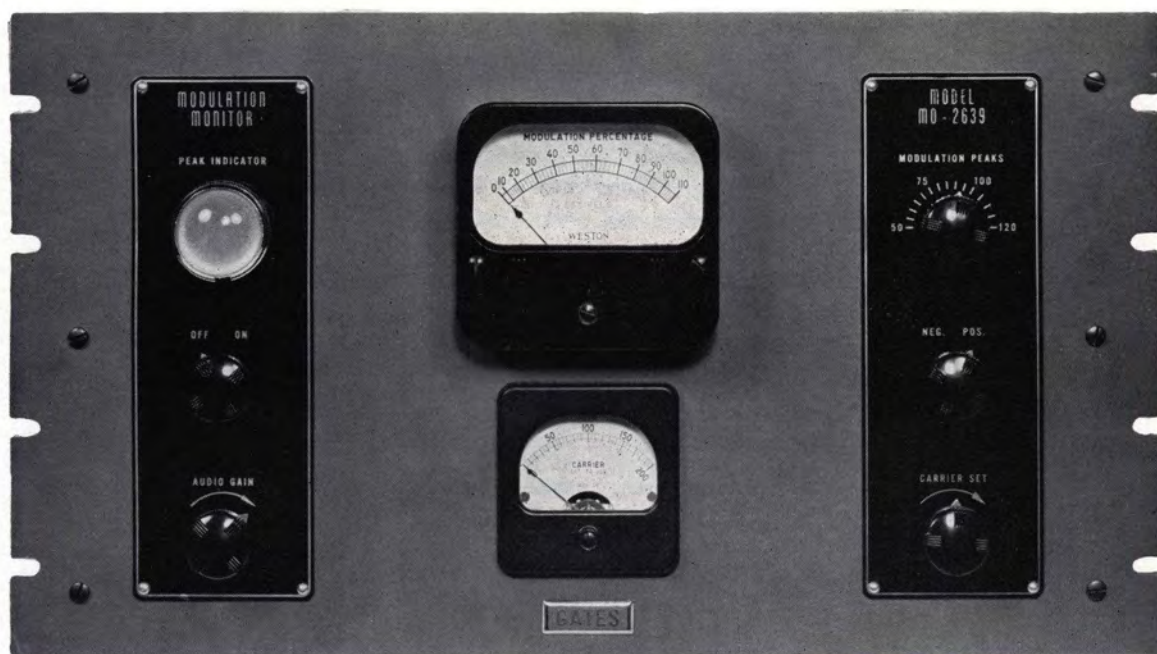

The MO-2639 is an accurately performing modulation monitor that meets all present day broadcast requirements, and will operate on both standard and high frequency service up to 24 megacycles. Exclusive is the self-contained high level amplifier which, when connected to any good loud speaker, allows direct off-the-air monitoring along with accurate visual indication. The conservative styling and finish in medium gray with black escutcheons assures excellent matching to any make of equipment.

MO-2639 MODULATION MONITOR

Designed to meet exacting FCC requirements, the MO-2639 modulation monitor indicates exact percentage of modulation. As a bonus exclusive there is also provided a self-contained high level amplifier, which may be connected to any excellent quality speaker for high fidelity off-the-air monitoring. In many cases this eliminates the need of a separate monitoring amplifier.

A 4" meter is calibrated from —15 db to 0 db and 0-110% modulation. A neon lamp, located behind a large "bull's-eye" on the front panel, may be adjusted to flash at the maximum percentage of modulation desired. A carrier meter allows direct center scale reading for proper radio frequency input. Front panel controls include carrier set adjustment, positive-negative peak control, peak indicator adjustment, audio amplifier gain control, and off-on switch. Each monitor is carefully manufactured and tested in accordance with specifications set forth by FCC Standards of Good Engineering Practice, and has been approved by the FCC for use in all standard broadcast stations.

SPECIFICATIONS

FREQUENCY RANGE—100-20,000 kilocycles.
INPUT—High impedance requiring about ½ watt excitation.
LOUD SPEAKER IMPEDANCE—4 to 8 ohms.
TUBES—Three 6X5, three 6C5, one each 6F6, 885 and VR150, plus one neon flasher light and two 6 volt meter lights.
MODULATION PERCENTAGE RANGE—0-110%.
CARRIER LEVEL METER RANGE—0-200%.
DECIBEL SCALE RANGE—Calibrated to 15 db below 100% modulation.
AUDIO AMPLIFIER—Range exceeds best quality speaker capabilities.
POWER CONSUMPTION—65 VA. at 115 volts 50/60 cycles.
FCC APPROVAL NUMBER—1556.
WEIGHT—Net, 27 lbs. Gross, 40 lbs.
DIMENSIONS—10½" high, 19" wide, 13½" deep.
Packed for shipment, 3.7 cu. ft.

Modulation Monitor, complete with one set of tubes.

Cat. MO-2639

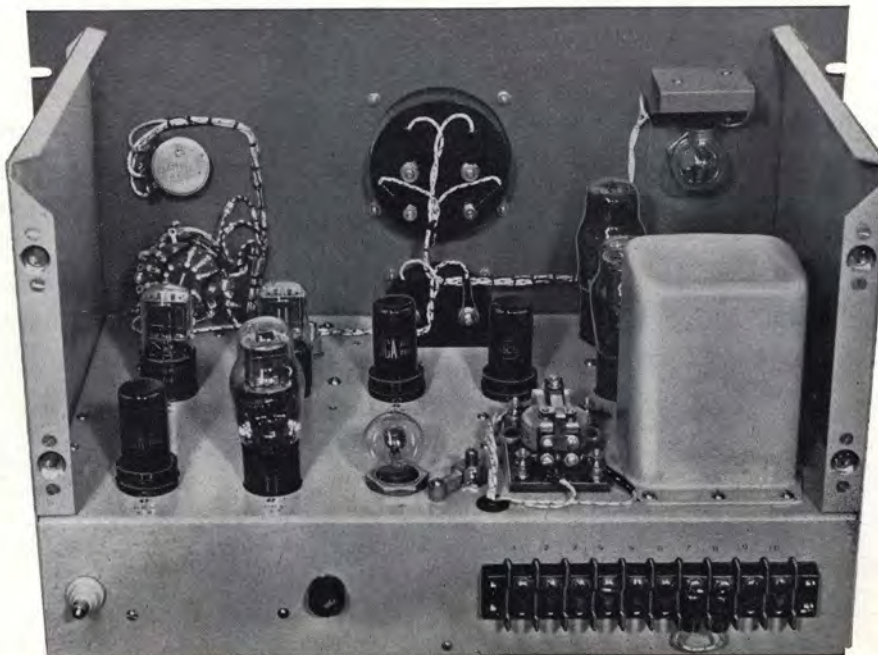

Rear dust cover removed—MO-2639 Modulation Monitor

MO-3066 Accessory Cabinet



SPECIFICATIONS

For use with all amplitude modulated broadcast installations, the MO-3066 accessory cabinet provides complete monitoring, audio, and switching facilities. A complete rack cabinet equipment, it offers several desirable advantages over the purchase of the individual units, including complete factory wiring, unified appearance both symmetrically and colorwise, and the supply of coaxial cables for connection of both monitors to the transmitter.

Standard equipment supplied is the Gates MO-2639 modulation monitor, MO-2890 frequency monitor, choice of type SA-38 or SA-39 limiting amplifier, input switching panel, blank panels, and complete wiring. The cabinet is the Gates DM-1X, which matches all Gates equipment. The medium tone of gray also assures excellent match to most commercial colors. The input switching panel accommodates three 600 ohm input circuits, selected by a switch on the front panel. These are generally used for two telephone lines and a third input, such as a transcription turntable, microphone preamplifier, or tape recorder. A second switch is provided so that the limiting amplifier may be cut in or out of the circuit, such as for emergency tube replacement.

Size—78" high, 23 $\frac{1}{4}$ " wide, 20 $\frac{1}{2}$ " deep. For detail on individual equipment in the MO-3066 accessory cabinet, refer to other pages in this catalog (see Index). For FCC filing data, state type number of frequency and modulation monitor, and not that of the accessory cabinet.

Ordering Detail

Complete Accessory Cabinet, including one set of tubes, crystal to customer's operating frequency, and with SA-38 limiting amplifier.
Cat. MO-3066

Complete Accessory Cabinet, same as above but with SA-39 limiting amplifier.
Cat. MO-3066A

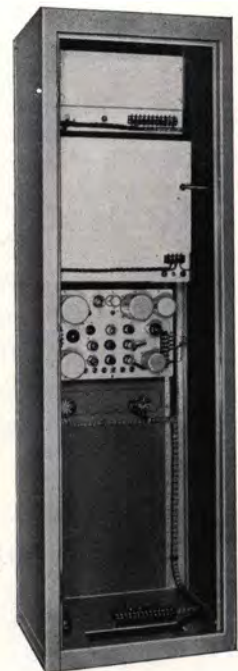

VFO and Crystal Oscillator/Amplifier

(Model MO-4230)



Control of operating frequencies between 540 and 1600 kc is possible without the use of crystals through use of this very accurate variable frequency oscillator. Provision is also made for a crystal with temperature controlled oven. Though primarily used where rapid frequency change is desired, the MO-4230 unit has many other interesting applications.

MO-4230 VFO/CRYSTAL OSCILLATOR/AMPLIFIER

Recent requirements for rapid change of operating frequency in the standard broadcast band, such as in mobile broadcasting where the operating frequency varies in different areas, or in military requirements, has brought forth the Gates MO-4230 combination variable frequency oscillator and crystal controlled unit.

Designed specifically to replace the oscillator unit in several types of Gates transmitters, it may, because of the conservative size, be used either internally or externally with other types of equipment operating between 540 and 1600 kc. The variable frequency oscillator, or VFO, is reactively controlled, employing a 6V6 oscillator and VR75 regular tube. Negative coefficient capacitors pad the reactive circuit to reduce effect from temperature change. Fundamental output is provided from 500 to 1100 kc, and operation above 1000 kc is provided by doubling. This allows appreciable capacity to be maintained in the reactive circuit for optimum stability.

For the VFO three stages are employed—a 6V6 oscillator, 6V6 untuned intermediate amplifier, and 807 output amplifier, producing about two watts, or enough to excite one or two 813 tubes as succeeding amplifiers. When the crystal is used in-

stead of the VFO, the untuned intermediate amplifier becomes the crystal oscillator stage with ten cycle accuracy realized from a temperature controlled crystal. Output impedance is either 70 ohms for link coupling, or high impedance for capacity coupling. An output control is provided in the high impedance portion to prevent overdriving a succeeding stage.

The VFO tuning dial with vernier provided allows a reading accuracy of 1 part in 5000. Calibration is in 10 kc steps, and a chart is provided with each unit. Provision is made for a Gates type JK-57 plug-in crystal and oven, which operates at the ordered crystal frequency simply by switching into the circuit. Front panel equipment includes micrometer dial for VFO, vernier directly below, VFO/Crystal switch in center, crystal trimmer capacitor left of meter, 807 tuning condenser above meter, output excitation control, and output band switch. The meter indicates 807 plate current. Power requirements for both filament and plate allow for easy adaptation to the existing transmitter power source or one of several Gates power supplies listed elsewhere in this catalog (see Index). Where desired, the two 6.3 volt filament circuits may be paralleled, which would then necessitate operating the tube filaments at all times.

SPECIFICATIONS

OUTPUT FREQUENCY—540-1600 kc.

POWER OUTPUT—Approximately 2 watts.

OUTPUT IMPEDANCE—70 ohms and high impedance.

POWER REQUIREMENTS—6.3 volts at 1.45 amps., 6.3 volts at 1.35 amps., 350 volts DC at 60 ma. (6.3 volt windings may be paralleled if desired.)

CALIBRATION—10 kc steps.

DIAL CALIBRATION—1:5000.

DIAL DIVISION—200 cycles/division.

DIAL CURVE—Straight line.

TEMPERATURE COEFFICIENT—0.0005% degree F.

STABILIZING TIME VFO—120 minutes*.

VFO ACCURACY—After 120 minutes, ± 200 cycles**.

CRYSTAL ACCURACY— ± 10 cycles.

TUBES—Two each 6V6, one each 807, VR75.

SIZE—19" wide, 10½" high (less shock mounts if used), 6½" deep.

WEIGHT—Net 24 lbs., gross packed 50 lbs.

* Stabilizing time will vary with air stream conditions, but the above is considered maximum in most cases.

** Tolerance specified may be exceeded under extreme variable conditions of temperature. Under normal conditions, tolerances stated are conservative.

VFO/Crystal Oscillator and Amplifier, with one set tubes.
Crystal and Oven (state frequency when ordering).

Cat. MO-4230
Cat. JK-57

Transmitter Control Console

(For Use With All Powers)



This new control console is designed for use with any Gates transmitter of either standard or high frequency design. It provides several input circuits, extension audio indicating meters, remote start/stop functions and associated indicator lamps. The functional diagram MO-4055 on opposite page provides excellent explanation of circuit functions. Gates rack mount plug-in amplifiers, Gates limiting amplifiers or Gates SA amplifiers may be used in association with this console as required. Other equally satisfactory audio equipment may, of course, be employed.

Transmitter Control Console Technical Detail

A new and modern transmitter control console for use with any broadcast transmitter of standard design. Available with or without desk, and with or without extension modulation monitor meter.

SPECIFICATIONS

INPUTS—Three provided with isolation transformer at input side. 50/150/600 ohms provided by transformer taps. Controls 20 step 2 db per step ladder.

MASTER—A balanced 30 step 1.5 db per step control so wired to be connected in circuit as desired by purchaser. Input and output 600 ohms.

OUTPUT—From the 3 input circuits 50/250/600 ohms. From the master gain control 600 ohms.

VU METER—Standard 4" scale B with range control +4 to +40 VU in 2 VU steps. Input 7500 ohms. Meter is illuminated.

MODULATION METER—Gates A-1363-2 for use with Gates MO-2639 FCC approved modulation monitor. Meter is illuminated.

PUSH-BUTTONS—Standard start/stop (black, start—red, off). Four sets provided to cover all possible combinations including automatic reset as on Gates 5 kw and 10 kw transmitters.

PILOT LAMPS—Two provided to indicate filament on and plate on.

SIZE—24" wide, 21½" deep, 10" high. Cabinet swings up from base for all servicing and connections. See illustration opposite page.

DESK—Where desired, purchase Gates CB-63, listed Page 34 Gates speech input catalog.

Transmitter Control Console with extension modulation meter. Cat. CCD-2

Transmitter Control Console, same as CCD-2 but modulation meter omitted and blank plate placed over meter hole. Cat. CCD-2A

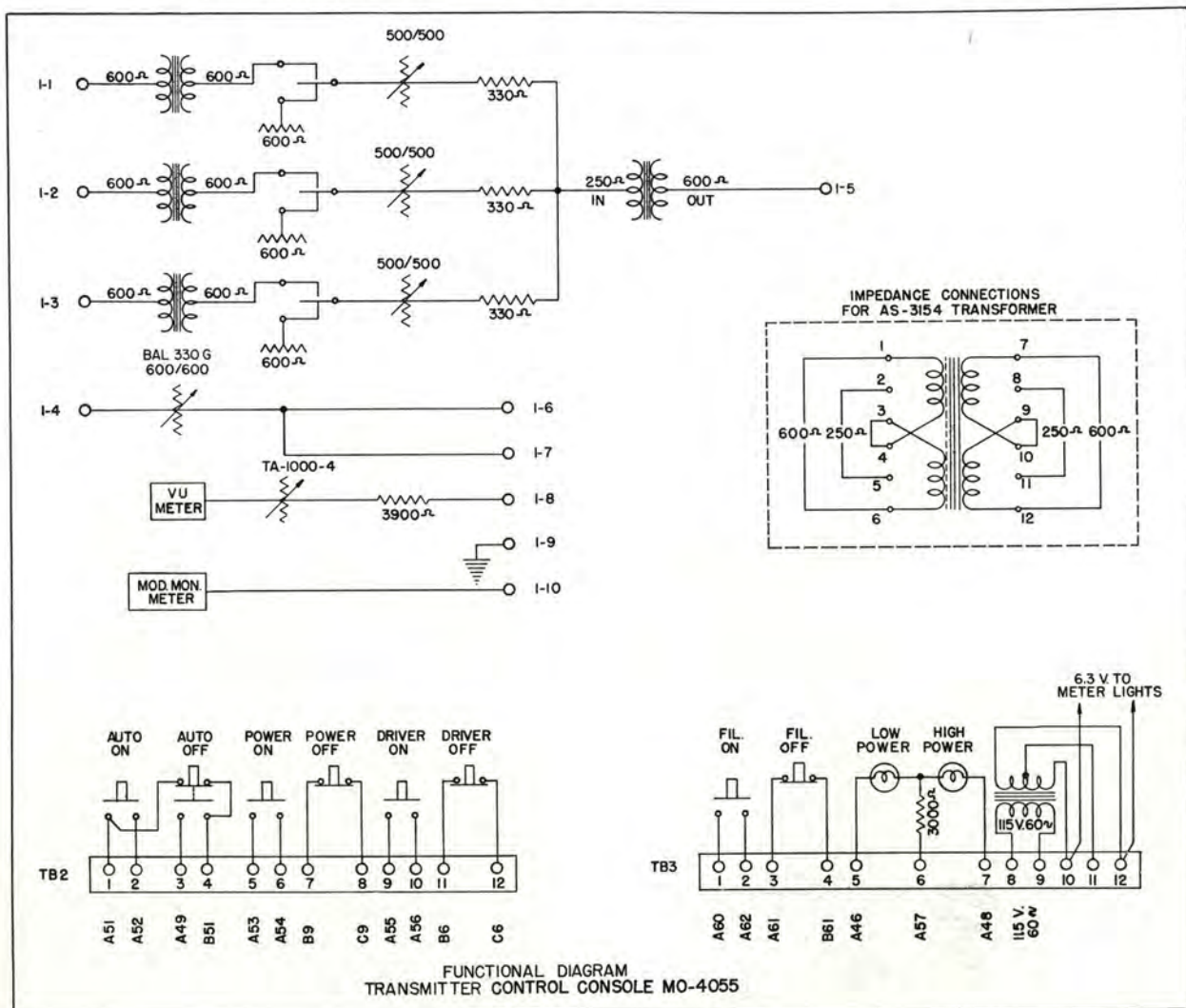

Transmitter Audio Panel



For the transmitter installation this unique equipment supplies, in compact form, all audio input requirements. Six input circuits are accommodated by push-button switches. One circuit includes a two stage preamplifier so that any standard low level microphone may be used. Two inputs are provided for turntables or tape recorders, and three inputs for incoming lines. Basic construction is on an SA-800 rack panel housing. This holds the preamplifier, four stage program amplifier, and power supply as illustrated below. Front panel equipment includes a 4" VU meter with push-button range switch to permit readings of +8, +12, or +16 VU, two ladder type input controls, master gain control, and headset jack. Nothing has been overlooked in making this unit complete. Muting relay for silencing monitor speaker when microphone is in use, repeater transformer for incoming telephone lines, and drop-down front panel servicing are all part of

the design. For the station broadcasting part time from the transmitter site, or requiring an excellent facility elsewhere for audio input control, the SA-89 equipment is ideal.

SPECIFICATIONS

- TUBE COMPLEMENT**—SA-70 Preamplifier: one 6J7, one 6C5. MO-3094 Line Amplifier: one 6J7, one 6C5, one 6SJ7, one 6SN7. Power Supply: one 6X5GT.
- OVERALL GAIN**—Microphone channel, 110 db; Turntable channels, 70 db; Remote channels, 64 db.
- FREQUENCY RESPONSE**—Plus or minus 1½ db from 30 to 15,000 cycles.
- DISTORTION**—Less than 1% at plus 16 dbm from 50 to 15,000 cycles.
- NOISE**—60 db or better below plus 16 db through microphone channel (noise measurement is made 60 dbm input to microphone channel and plus 16 dbm output from line amplifier).
- POWER REQUIREMENTS**—Approximately 30 watts from 115 volt 60 cycle AC line.
- DIMENSIONS**—19" wide, 14" high, 8¾" deep behind front panel.
- WEIGHT**—Packed for shipment, 90 lbs.

Transmitter Audio Panel, with one set of tubes. Cat. SA-89

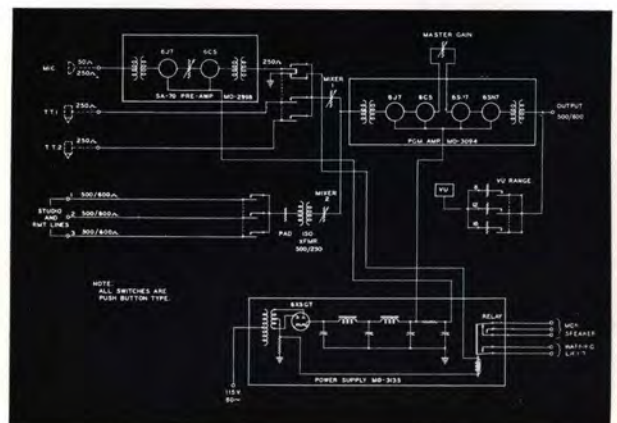
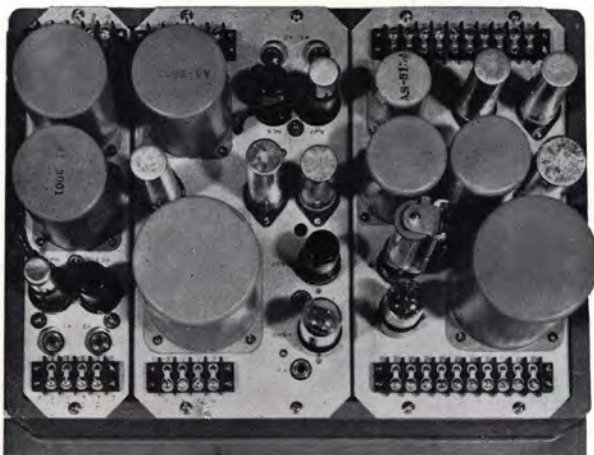

Complete "Proof of Performance" Package

(For all AM and FM measurements)

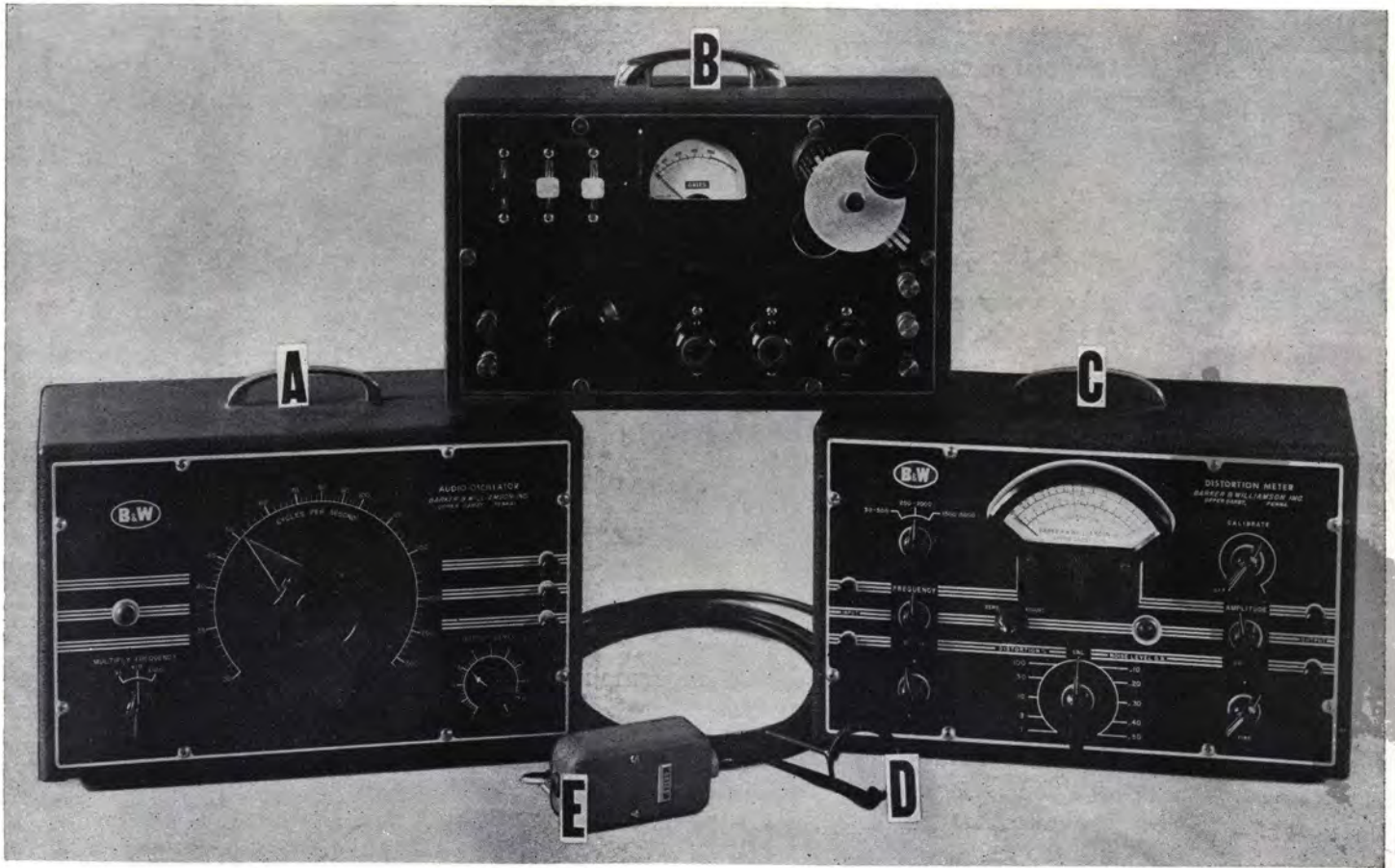

Now, a complete proof of performance package is available to broadcasting stations in a form that assures accurate results and complete facilities to check audio and radio frequency performance without the need of any additional apparatus. There are five basic units, all described in detail on the opposite page and alphabetically illustrated above as (A) the type 200 audio oscillator, (B) the MO-3625 gain set, (C) the type 400 noise and distortion meter, (D) the RF pickup coil for transmitter measurements, and (E) the MO-3626 diode rectifier unit for transmitter measurements in conjunction with the noise and distortion equipment.

The complete SA-131 proof of performance package has been worked out after weeks of study of broadcast station measurement problems. This package

will accurately measure either from low level microphone circuits or high level transmitter input circuits. The diagram below illustrates a typical overall test arrangement. Many other combinations are possible as the experienced radio engineer will quickly recognize. The package is so arranged that it may be used for testing a single amplifier as conveniently as it can be used for testing a complete studio-transmitter installation. Complete instructions for use are supplied with each equipment.

Modesty in the complete package price makes the Gates SA-131 proof of performance kit a necessity even where license renewal is not of immediate consideration. Continued assurance of quality transmission by periodic checking is a vital necessity in present day competitive broadcasting.

Complete Proof of Performance Package, with tubes. Cat. SA-131.

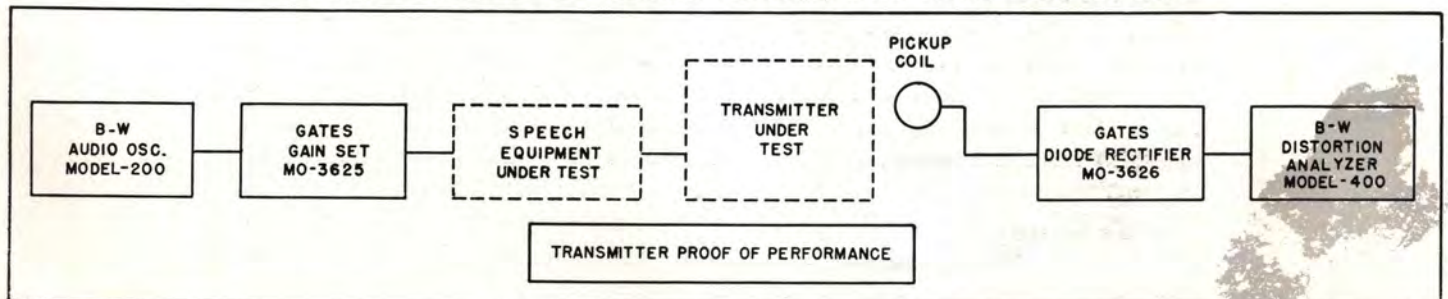

SUMMARY OF FCC REGULATIONS ON PROVING PERFORMANCE

FCC regulations sometimes become confusing, due to the necessary way that regulations of all kinds must be prepared. As a result, our engineering department has read over these regulations and discovered the following points to be of particular interest.

1. The original rule regarding proof of performance was to be established and made effective in the year 1949, but was suspended for one year due to the cost to broadcasters, and other factors.
2. Since the year 1950 all standard AM stations, as well as FM broadcast stations, have been required to make a complete proof of performance as to frequency response, noise and distortion at least once annually, and preferably the last four months of each calendar year, or coincidental with the time that any license renewal is requested.
3. This information is not posted with the FCC unless specifically requested, but the renewal forms carry a direct question asking if these measurements have been made, and if they prove that the equipment is operated in accordance with the Standards of Good Engineering Practice as set forth by the Federal Communications Commission.
4. The measurements must be recorded as a written report, and kept at the radio transmitter building for examination by the FCC field inspectors at any time requested.
5. The FCC does not specifically approve nor disapprove any particular equipment for making the series of tests, as long as there is every evidence that the equipment being used is satisfactory and is functioning properly.
6. The FCC does not demand that broadcast stations own the equipment. This means that others who own equipment may be engaged to do the work. It is specifically pointed out, however, that the intent of the proof of performance rule is to keep all broadcast stations operating from the standpoint of top quality transmission. It is the opinion of Gates that top quality transmission cannot be maintained by an annual check. We feel that checks should be made at least once every month. Therefore, for the conscientious broadcaster, owning the equipment is desirable.

Is Proof of Performance Important?

Although the Federal Communications Commission requires proof of performance, the importance of taking regular measurements should not be judged on the basis that it is a mandatory regulation. Much more important is the resultant rich transmission quality. This means more listeners and greater respect from your advertising clientele. It totals to more income. Like the regular check of the airliner or streamliner at the end of the run, proof of performance is intangible. Few will continue to patronize the airline that neglects proving its performance. Broadcast listeners have a habit of neglecting mediocre sounding radio stations in favor of those pleasing to the ear. Keeping equipment in good repair is very important, but keeping this same equipment in a top listenable condition by regular "proof of performance" measurements is an obligation to listener, advertiser, and broadcaster alike.



Below—Functional diagram of MO-3625 gain set illustrated and described at top of page.

MO-3625 Gain Set. Designed basically for use in audio input circuits so that extremely low input levels may be employed and input meter reference provided. It may be successfully used as output meter also. Cabinet, size 12 $\frac{3}{4}$ "x8 $\frac{3}{4}$ "x4", matches the audio oscillator and distortion meter listed below. Has etched aluminum front panel. Consists of a VU meter provided with associated switches to accommodate all usable ranges for measuring purposes. The attenuation circuit includes a 10 step, 2 db per step variable attenuator of the balanced ladder type and fixed plug-in pads which may be used in any number from 1 to 3. These pads are used for both attenuation and impedance matching. Two are supplied, providing 40 db attenuation 600/600 ohms and 20 db attenuation 600/250 ohms, both balanced H. Additional pads of any desired loss or impedance are obtainable, but are not considered necessary for standard proof of performance. Equipment is completely shielded and may be used in the field of a radio transmitter.

SPECIFICATIONS—INPUT IMPEDANCE: 600 ohms, balanced. OUTPUT IMPEDANCE: Variable 30 to 600 ohms, balanced. OUTPUT LEVEL: Variable from plus 21 dbm to minus 136 dbm. RESPONSE: Plus or minus 0.5 db, 30-15,000 cycles. DISTORTION AND NOISE: Negligible.

Gain Set complete. Cat. M-3625.

Type 200 Oscillator. Direct reading at stability of better than 1%, this oscillator is ideal for all distortion and frequency response measurements. No zero reset or line calibration required. Power supply self-contained. Completely shielded in steel cabinet 13 $\frac{3}{4}$ "x7 $\frac{1}{4}$ "x9 $\frac{1}{2}$ ". Voltage output, 11 volts into 500 ohm load. R. M. S. harmonics at 5 volts output into 500 ohm load less than 1%, or into open circuit less than 0.5% at all frequencies between 50 and 15,000 cycles. Response plus or minus 1 db, 30-30,000 cycles. Calibration, plus or minus 2.5%.

Oscillator with tubes. Cat. JI-200.

Type 400 Noise and Distortion Meter. An excellent quality noise and distortion measuring equipment with variable frequency selector filter providing a single frequency suppression circuit between 50 and 15,000 cycles. Size matches Type 200 oscillator listed above. Frequency range (a) distortion meter; for fundamentals from 50-15,000 cycles measuring harmonics to 45,000 cycles; (b) has voltmeter and db meter 30-30,000 cycles. Sensitivity (a) noise and distortion measurements; minimum input 0.3 volts; (b) voltmeter full scale readings of 0.3, 0.1, 0.03, 0.01 and 0.003 volts. Calibration for distortion measurements, plus or minus 10%; for noise measurements, plus or minus 1 db; for voltage measurements, plus or minus 5%.

Noise and Distortion Meter with tubes. Cat. JI-400.

MO-3626 Rectifier and Pickup Coil. Used in conjunction with the type 400 distortion meter when measuring AM transmitters. Supplied with pickup coil ready to attach to tank circuit of transmitter with 15 ft. section of coaxial cable. Designed around a germanium diode. Complete R. F. filtering guarantees a pure audio output free from R. F. disturbances.

FREQUENCY RANGE: 550-20,000 kc. **RESPONSE:** Plus or minus 1 db, 30-15,000 cycles. **OUTPUT IMPEDANCE:** 600 ohms, unbalanced. **OUTPUT LEVEL:** Plus 12 dbm. **NOISE AND DISTORTION:** Negligible. **SIZE** 4" long, 2" wide, 1 $\frac{1}{4}$ " high.

Rectifier and Pickup Coil. Cat. M-3626.

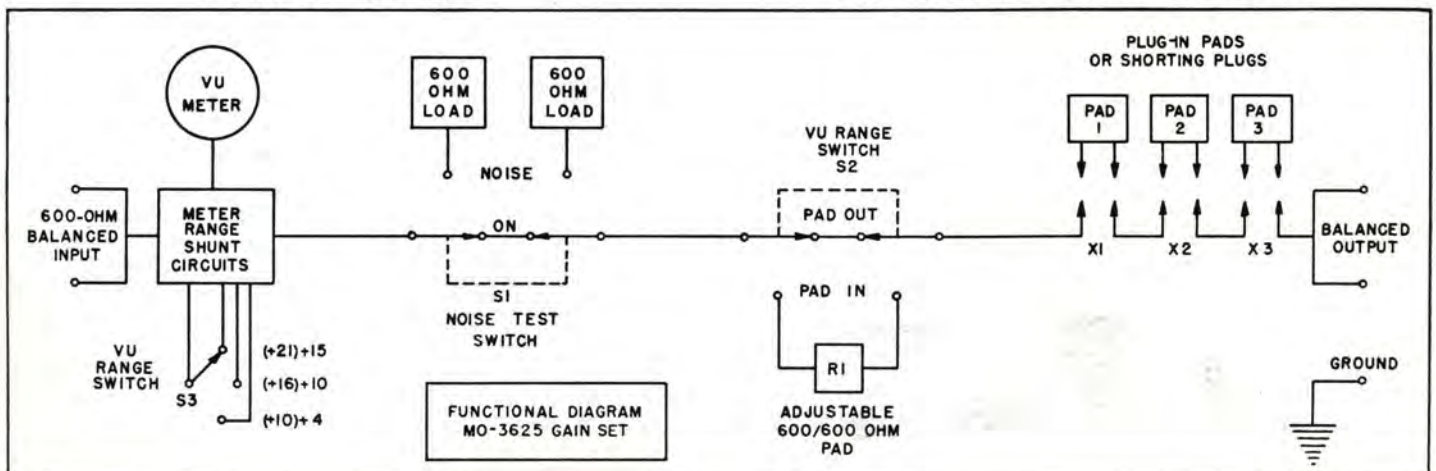

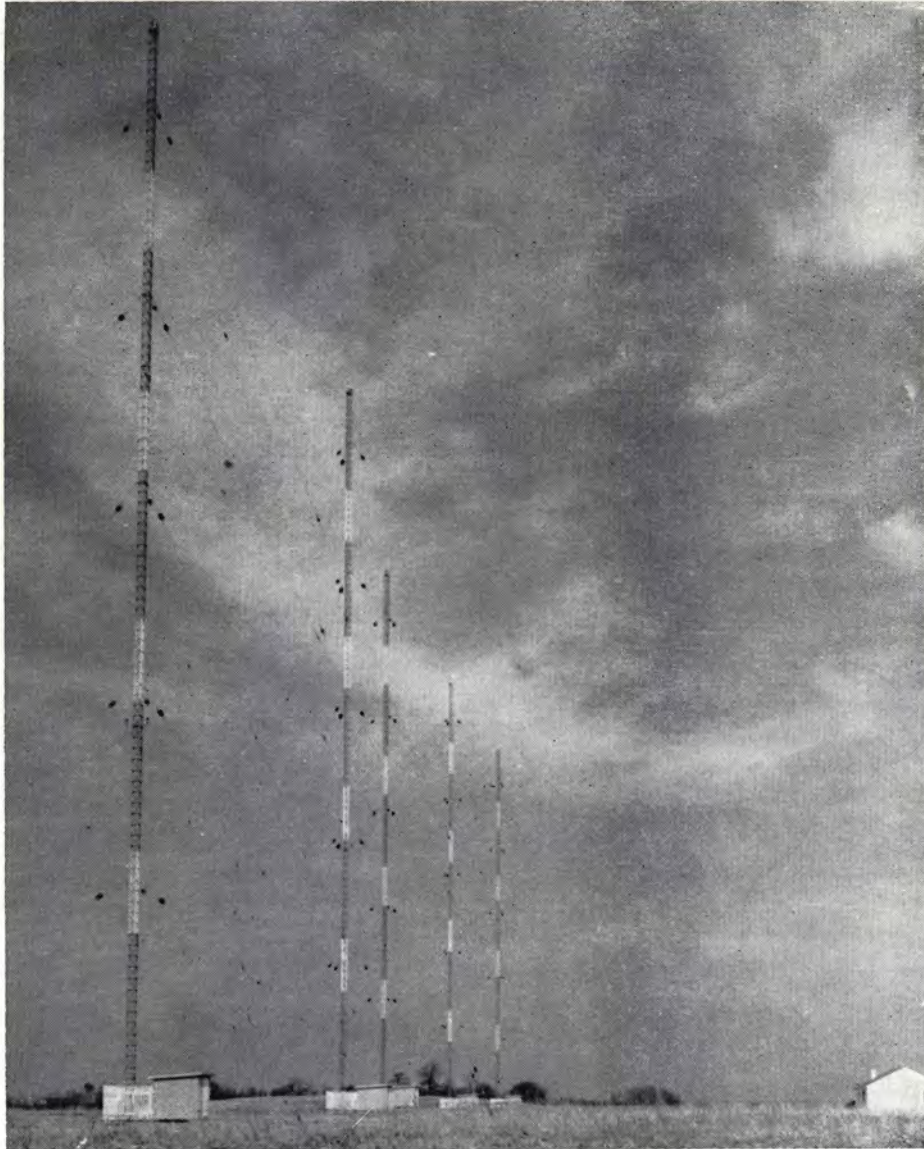

Antenna Coupling and Directional Phasors

Gates engineers have always taken particular pride in the fact that Gates phasing and antenna coupling equipment is endorsed by leading engineers in the electronics field. We feel that this is, in a large part, due to the stressing of rugged mechanical design, as well as excellent electrical design and performance. Perhaps the fact that many Gates men have also been broadcast men of good repute is the reason that coils, for example, are often oversize because of the realization that smaller sizes may break down under the added heat of a mid-summer sun beating down on a totally enclosed tuning house.

Gates engineers know that the omission of a meter shorting switch could, under certain conditions, mean the ultimate loss of the entire equipment from lightning damage. Phasing and coupling equipment similar to that listed on the following pages will be found in hundreds of broadcast stations all over the globe. We feel certain that, whether requirements involve low power or 100 kilowatts, Gates phasors and coupling equipment will be appreciated by the most discriminating engineer.

Antenna Termination Equipment

(For Directional Installations)

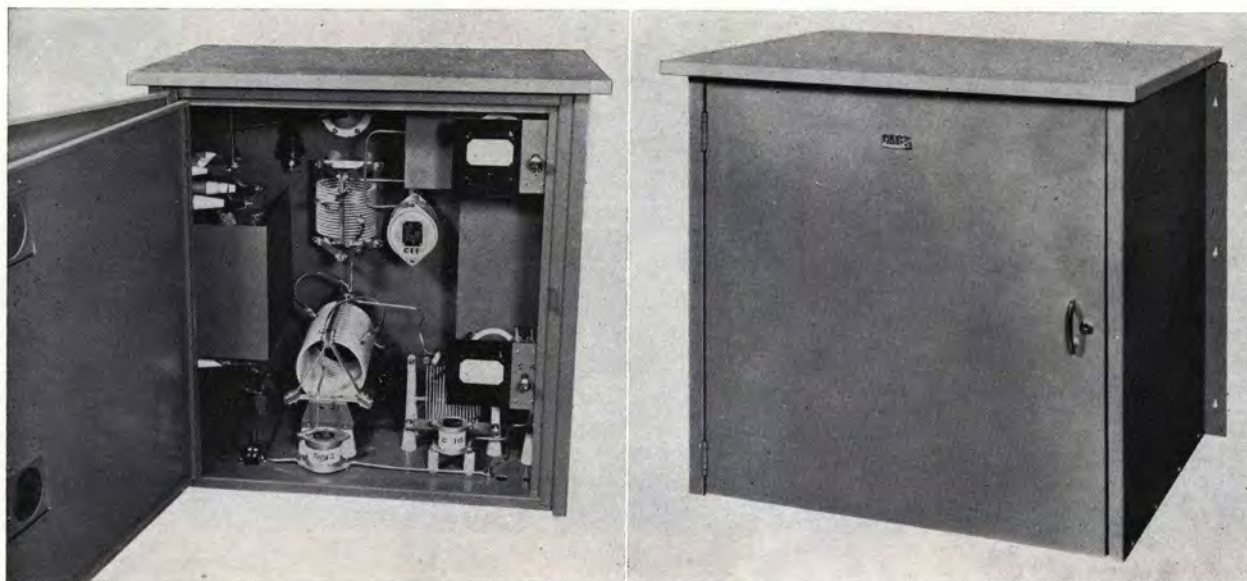

Typical Weatherproof Antenna Coupling Unit

Phasing equipments, as illustrated on the following pages, are usually quoted and supplied with antenna termination equipment as listed on this page. As in the case of centralized phasing equipment, the antenna termination equipment is designed to the particular specification set forth by the consultant. In converting the consulting engineer's electrical specifications to the actual product, the finest of conservatively rated materials are always used.

Mechanically, two types are available. If the broadcaster provides his own tuning house, the indoor shelf type is more economical and performs the same electrical function. The weatherproof design is used if no other protection is offered. Cabinet construction, in part, depends on such factors as power, operating frequency, and consultant's desires. Cabinets may be of welded aluminum or copper plated steel. In some cases, where practical engineering does not warrant the added expense, only a portion of the cabinet is plated or fabricated of non-ferrous metal. In most cases tower light isolation choke coils are part of, and mounted in, the termination housing. Solenoid relays and meter shorting switches are also supplied for termination equipment used in day-night pattern switching.

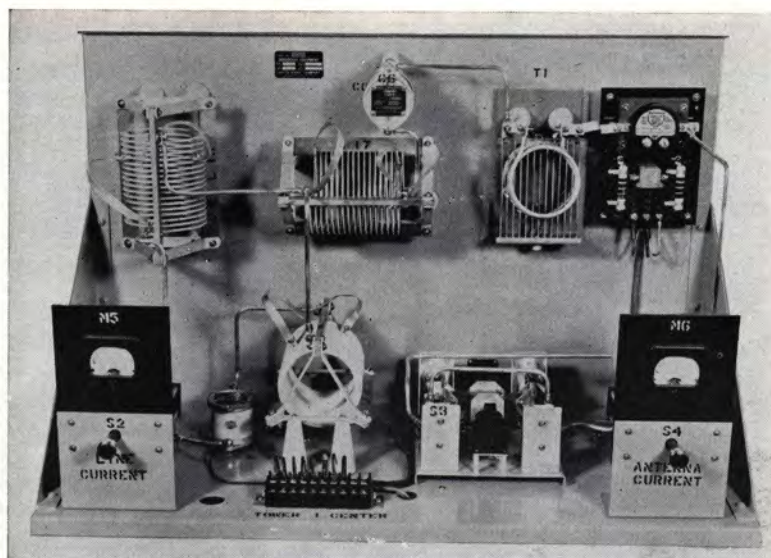

Indoor Shelf Type Coupler

If You Didn't Get This From My Site,
Then It Was Stolen From...

Directional Phasing Equipment

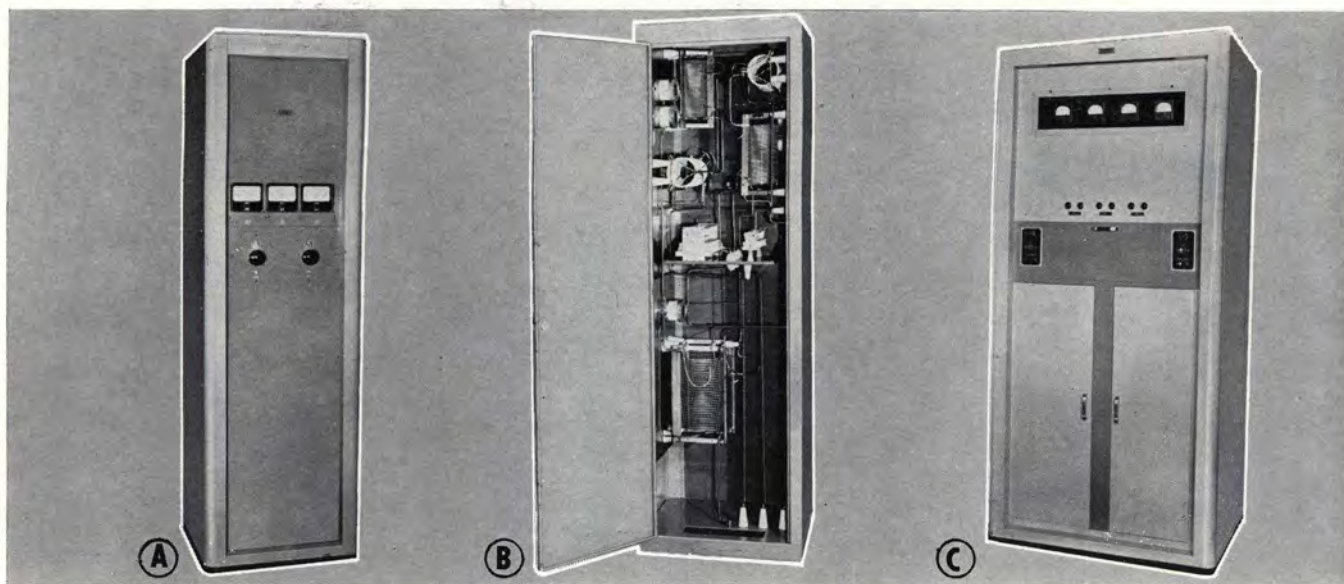

For multi-tower operation of radio broadcast stations, Gates manufactures to order every type of phasing equipment called for by the consulting engineer. As phasing equipment is manufactured to the engineering specifications of the individual station, the illustrations on these pages must speak for themselves.

Gates phasors are well known for rugged design, involving conservatively rated components, ease of tune-up, and stability. Coils are generally of edgewise ribbon design, silver plated and Micalox insulated. Variable coils have heavy cast end-bells to provide strength. A rotating wheel grips both sides of the edgewise ribbon for an electrical contact which exceeds the rating of the coil. Mica or vacuum capacitors are employed, as specified by the consultant.

For pattern change, impulse type relays are used exclusively so that the relay coil is energized only during the moment of pattern change. Meters vary, both in size and standard or expanded scale, in accordance with consultant requirements. Antenna termination equipment is listed on the following pages. Phase monitors, sampling loops and other material pertinent to the phasing installation will also be found in this catalog. (See Index).

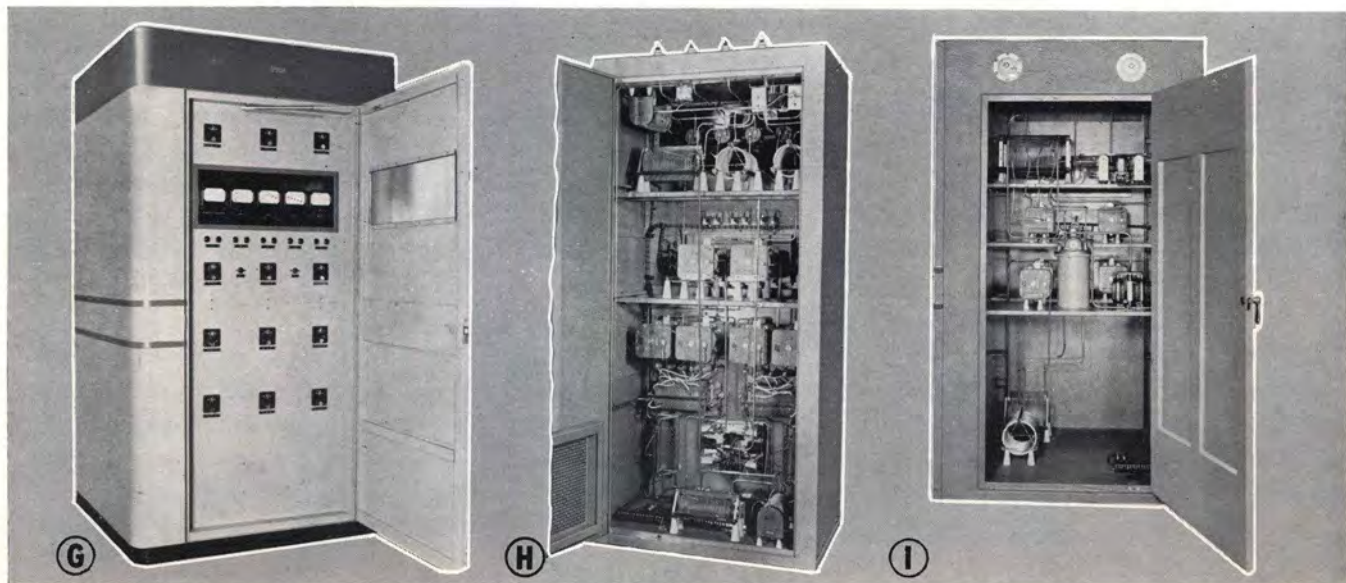

Directional Phasing Equipment

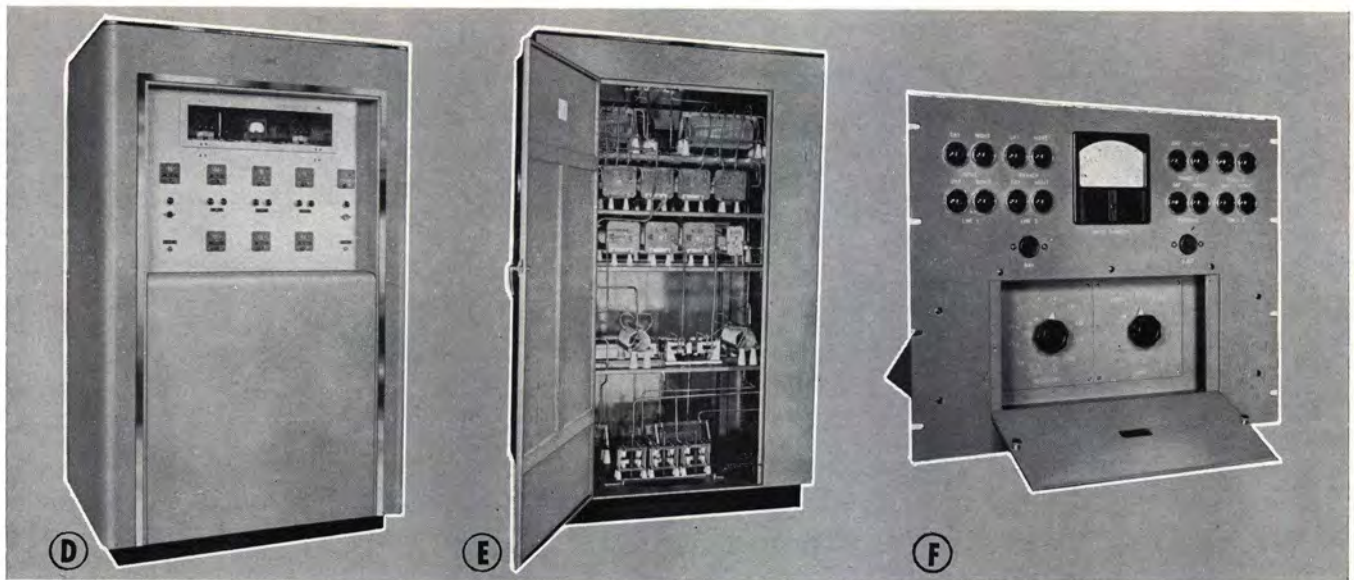

Though Gates will manufacture phasing equipment to match the styling of any transmitting equipment, the several designs of Gates manufactured cabinets effect a substantial saving, and are suggested as preferable. Phasors will be supplied in any color combination desired.

ILLUSTRATIONS: A—three tower phasor in custom cabinet. B—rear view of A. C—three tower phasor in Gates medium size cabinet. D—two tower phasor no pattern change. E—rear view of D. F—remote panel for motor tuning of antenna coupling units in phasors. G—front view of Gates three tower phasor to match competitive equipment. H—rear view of G. I—two tower 10KW phasor in large Gates cabinet. J—four tower 10KW phasor in large size cabinet. K—rear view of C. L—two tower 10KW phasor.

ENGINEERING: All Gates phasing equipment is manufactured to customer and consulting engineer specifications. Gates does not do field work in proving the performance of directional equipments, and suggests the employment of a consulting engineer for this task.

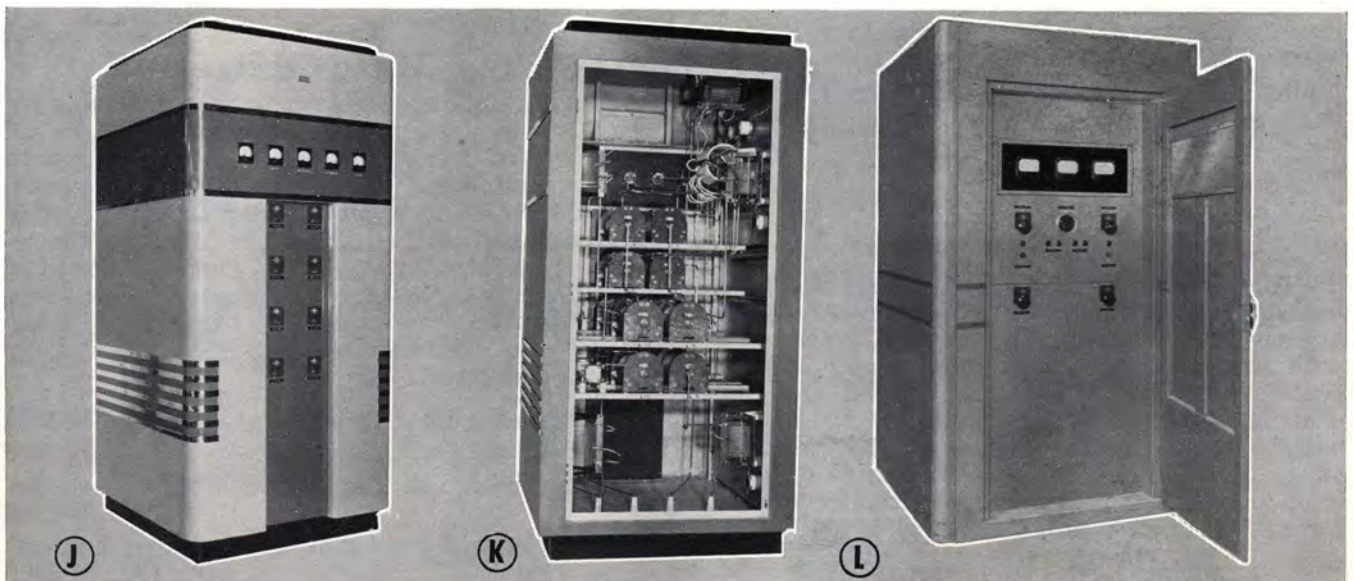

Antenna Termination Accessories



Sampling Loops

Offered herein are three different types of phase sampling loops, both variable and fixed. Heavily designed so that they will neither twist nor detune under icing or wind conditions.

SAMPLING LOOP M-3283, for phase and amplitude sampling of currents in towers comprising a directional array. Especially applicable where high current ratios are to be sampled, since the loop may be rotated so that phase monitor amplitude values are nearly equal. Electrostatically shielded and insulated from tower. May be used with or without isolation coil at base of tower. Coil is single loop of $\frac{7}{8}$ " coaxial cable, insulated from the main frame with large ceramic insulators. Will match either 50 or 70 ohm line. Size 60" high, 45" wide. Illustrated above.

Sampling Loop. Cat. M-3283

SAMPLING LOOP M-3389 is similar to that illustrated above, but consists of a loop of RG/8U coaxial cable within a $\frac{7}{8}$ " copper tubing. Provides unusually fine shielding, and eliminates external coupling by preventing the flow of undesirable currents in the outer conductor of the sampling line selected. Is adjustable and heavily insulated from the tower. May be used with or without isolation coil at base of tower. Size 63" high, 40" wide. Will match 51 ohm sampling line.

Sampling Loop. Cat. M-3389

SAMPLING LOOP M-3723 is a rather simple, heavily constructed loop that is non-adjustable and not insulated from the tower. Usually used with simple directional systems where the currents in the towers are nearly equal and high enough to cover up stray effects. Should be used with isolation coil at base of tower, and will match either 51 or 70 ohm lines. Constructed of aluminum angle and provided with Amphenol connector for RG/8U line. Size 60" high, 24" wide.

Sampling Loop. Cat. M-3723



Isolation Coil

For use at base of the antenna tower to isolate the sampling loop across the base insulator. Is a parallel resonant circuit with coil of $\frac{3}{8}$ " coaxial cable and insulated with Micalax. Inductance 85 uh with 150 mmfd tuning capacitor. A fixed capacitor parallels the variable, with size determined by antenna characteristics. Unit is fully waterproof, and housing has removable front door. Size 20" wide, 32 $\frac{1}{2}$ " high, 18 $\frac{1}{2}$ " deep.

Isolation Coil in housing, complete. Cat. M-3073

Isolation Coil, but less weatherproof housing.

Cat. M-4561

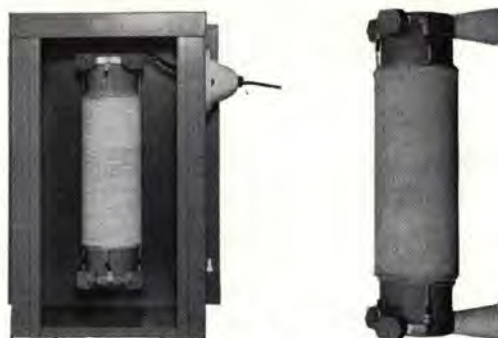

Tower Chokes

A heavily built solenoid type choke, available for either 2 or 3 circuit operation. Wound on XX bakelite and provided with mica bypass capacitors at each end of coil. Inductance 350 uh. Coil provided with 3" stand-off Alsimag insulator. May be purchased with or without weatherproof housing. Size, choke only, 18 $\frac{1}{2}$ " long, 5" diameter, and 7 $\frac{1}{2}$ " from bottom of insulator. Size, complete weatherproof unit, 24" high, 17 $\frac{3}{4}$ " wide, 10 $\frac{1}{4}$ " deep. Front cover has been removed for photographing.

Tower Choke Only, 2 section. Cat. M-3935

Tower Choke Only, 3 section. Cat. M-3936

Tower Choke, 2 section in weatherproof housing.

Cat. M-3937

Tower Choke, 3 section in weatherproof housing.

Cat. M-3938

Phase Meter for Directional Systems

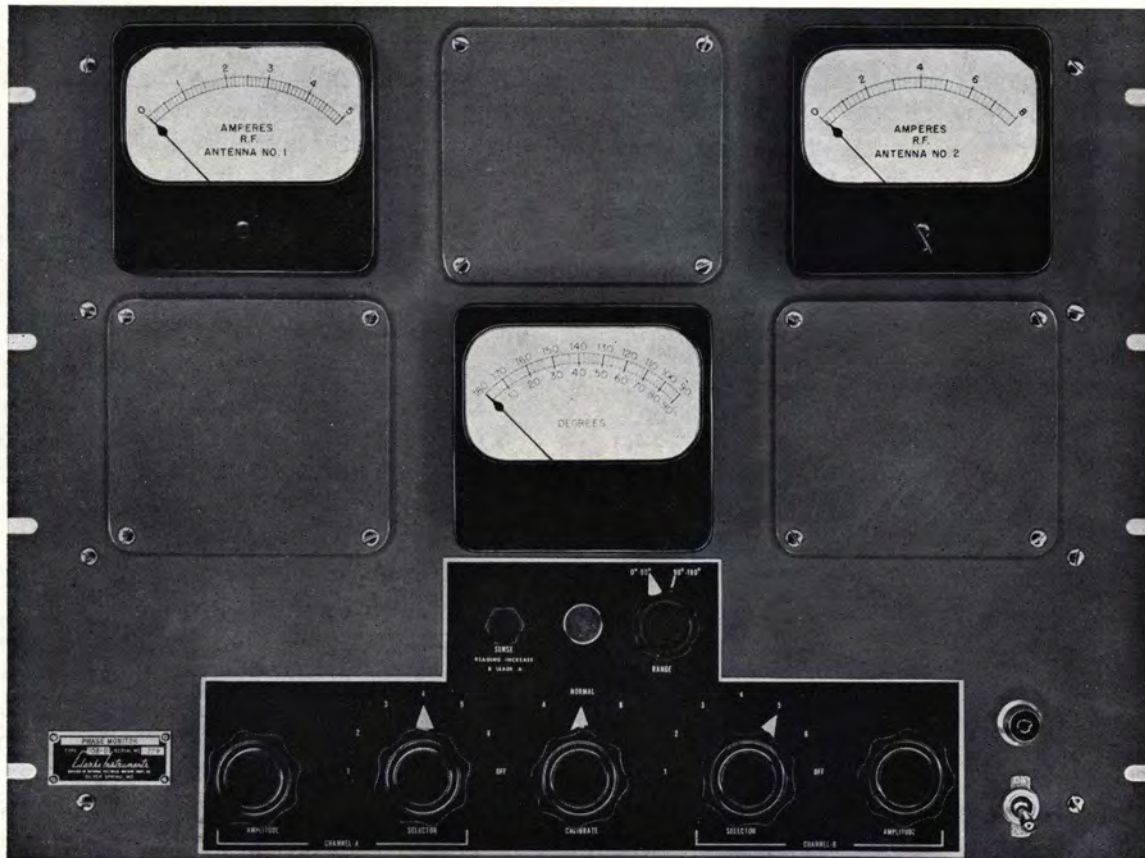

This excellent phase meter has been selected by Gates engineers and highly recommended to provide an accurate indication of phase relations in directional antenna systems. Each instrument is tailored for a particular installation, and incorporates provisions for indicating the relative amplitudes and phase relation of the currents in the several antennas. — Though the primary use is in directional antenna systems, the wide frequency range makes it adaptable to other applications.

... Supplied with remote meters

... Unaffected by modulation

... Available in standard model up to 4 towers

*... Similar models available for 5 or more towers
on special order.*

Phase Meter for Directional Systems

Phase meter reliability has been foremost in the minds of the designers of the Clarke 108 phase meter. With remote antenna meters supplied as standard equipment, it adds to the compactness, accuracy and ease of operation.

Terminals are provided on the rear of the instrument for connection to the transmission lines from the sampling loops. These terminations are substantially resistive, having a nominal value of 70 ohms or 50 ohms, as specified by the customer. The voltage appearing across the termination is rectified by the associated diode, and the direct current resulting from this rectification is metered by the remote antenna meter on the panel of the instrument. The constants of the circuit are so chosen that proportional relationship exists between the current in the regular antenna ammeter and the current flowing in the DC instrument on the phasemeter panel. Linear rectifiers are employed, and the indication does not vary with modulation as is the case when thermo-ammeters are used.

By means of SELECTOR switches associated with the input to two amplifier channels, the voltage across the termination of any of the transmission lines can be fed to a potentiometer in the grid circuit of either channel's amplifier tube. These potentiometers are used to adjust the amplitudes of the amplifier inputs to provide for equal voltages across the amplifier outputs. The two

amplifier channels feed into a common voltmeter circuit which adds the voltages and gives an indication of the vector sum. Since the outputs of the amplifiers have been individually adjusted to the same value, the channel meter gives an indication directly in degrees. A switching circuit permits the equal outputs of the two amplifiers to be combined in either of two ways. With the RANGE switch set in the 0-90 degree position the outputs of the amplifiers are combined in series, and the voltmeter reads the vector sum under this condition. With the switch in the 90-180 degree position the outputs of the two amplifiers are in parallel, and the meter reads the vector sum under this condition. Provision is made for indicating which one of the two elements being compared has a leading phase angle with respect to the other.

The operation of the instrument is simple. The two SELECTOR switches are set to the two elements to be compared. The outputs of the amplifiers are adjusted to a red mark on the meter. The switch is thrown, and the phase difference is immediately indicated. This indication is not affected by modulation provided 100% modulation is not exceeded.

The simplicity of the instrument, its freedom from modulation "jitter", its direct indication, and its easy operation have combined to make it a favorite with station engineers and consultants.

SPECIFICATIONS

- FREQUENCY RANGE—100 kc to 2 mc.
- PHASE ANGLE RANGE—0 to 360 degrees.
- MONITORING ACCURACY—1 degree.
- RESOLUTION— $\frac{1}{2}$ degree.
- R-F INPUT IMPEDANCE—50 or 70 ohms nominal.
- R-F VOLTAGE RANGE—1 to 7 volts.
- TUBE COMPLEMENT—2 6AU6, 2 OB3, 1 5Y3, 3 6AL5.
- POWER SUPPLY—105 to 125 volts.
- POWER CONSUMPTION—80 watts.
- DIMENSIONS—14" x 19" x 7".
- WEIGHT—20 lbs.

- | | |
|---|-------------------|
| Phase Meter complete for two tower directional. | Cat. JI-108 |
| Phase Meter complete for three tower directional. | Cat. JI-108A |
| Phase Meter complete for four tower directional. | Cat. JI-108B |
| Phase Meter for more than four towers. | to specifications |

When ordering, state operating frequency, remote meter ranges, type of sampling coaxial line and operating power. As all Phase Meters are tailored to exact needs, a slight delay in shipment is necessary.

Antenna Coupling Equipment

(Up to 1250 Watts Single Radiator)

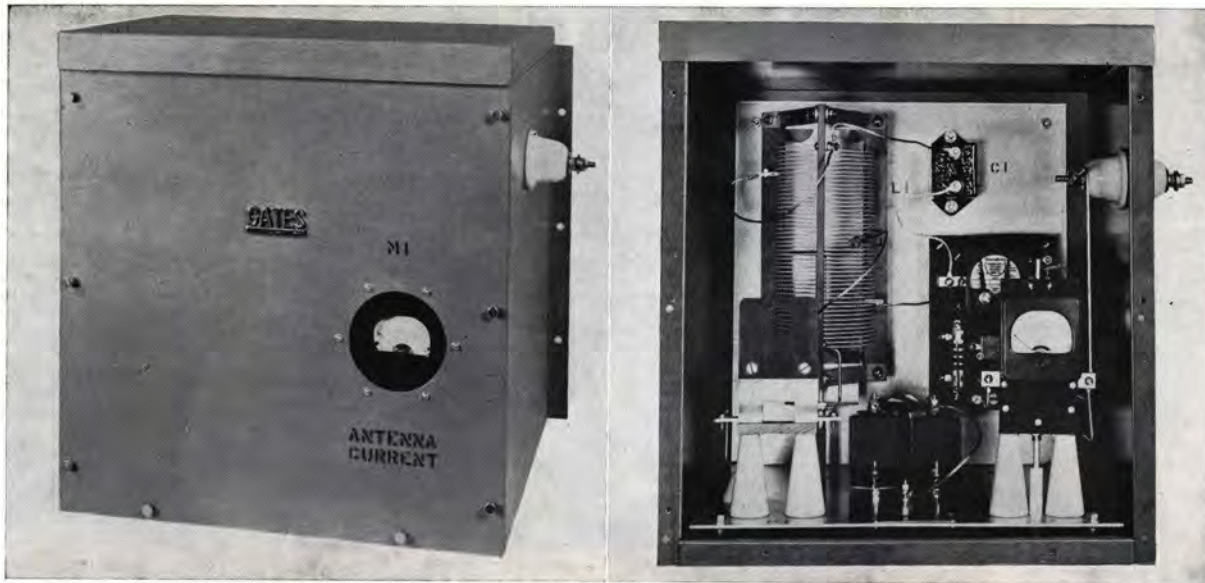

This antenna coupler is designed to couple all broadcast transmitters producing RF power up to 1000 watts (fully modulated) from any transmission line to a single vertical radiator. It is also available on special order for coupling to other types of antennas such as L or T wire antennas.

Constructed in a weatherproof housing with sealed front panel (removable), the coupler is 19 $\frac{3}{4}$ " high, 20 $\frac{1}{4}$ " wide and 18 $\frac{3}{4}$ " deep. Construction is of 16 gg. cold rolled steel, protected with a prime coat and a heavy finish coat in deep gray. Provision is made for the addition of either thermocouple or diode type remote metering equipment as desired. Remote metering equipment will be found listed on other pages of this catalog (see Index). A plug-in meter is supplied, normally connected in the antenna circuit but available for insertion in the line circuit for tune-up. A meter shorting switch is provided to replace the antenna meter circuit for lightning protection, and a shorting bar is supplied for the line when the meter is not in the circuit. A Tee network insures maximum harmonic attenuation. The coil is constructed of heavy edgewise ribbon, and mica capacitors are conservatively rated.

SPECIFICATIONS

- CARRIER POWER—1250 watts or less.
- INPUT IMPEDANCE—50 to 360 ohms, concentric or open line.
- ANTENNA RESISTANCE—10 to 1000 ohms.
- ANTENNA REACTANCE—Plus J 600 to minus J 300 ohms from 540 to 1000 kc.
Plus J 600 to minus J 500 ohms above 1000 kc.
- CIRCUIT—Tee network.
- LIGHTNING PROTECTION—Meter shorting switch.
- METERING—Plug-in 3" meter normally located as antenna meter but may be used as line meter for tune-up. Plug-in shorting bar provided for unused meter jack.
- REMOTE METERING—Provision for either thermocouple or diode type as ordered.
- SHIPPING WEIGHT—98 lbs.
- ORDERING INFORMATION—State transmission line impedance, operating frequency, tower height and height of base insulator above ground.

Antenna Coupler with meter, ready to install. Cat. No. 44

Antenna Coupling Equipment

(For 5 and 10 kw Single Radiator)



TWO excellent antenna coupling equipments are offered herein for use with 5 kw and 10 kw broadcast transmitters. Both are identical, except for power rating. The heavy waterproof cabinet with hinged front access door is made of 16 gg. cold rolled resistance welded steel, prime coated and finished with a gray protective coat for full weather protection. For certain frequencies, construction may be of aluminum or copper plated steel.

A Tee network, utilizing Micalox insulated edgewise silver plated coils associated with conservatively rated mica or vacuum type capacitors, as required, assures low harmonic radiation and best efficiency. If continuously variable tuning is required, variable coils are generally used in preference to variable air condensers. If size prevents the use of variable coils, coil clips are provided to allow tapping each turn of the coil. Metering is provided for both line and output circuits. Meter shorting switches are standard equipment. The illustration at the bottom of the page is that of a typical coupling unit, though it is emphasized that coupling units vary in design as to frequency and exact loading requirements. When ordering, the purchaser should provide all information possible, including full data on the tower or radiator, and line impedance. This equipment is for a single tower. For couplers used in multi-tower installations, see directional phasors listed elsewhere (see Index).

SPECIFICATIONS

CARRIER POWER—Model ACU-11 6 kw, Model ACU-12 12 kw (fully modulated).

INPUT IMPEDANCE—50-360 ohms as ordered.

ANTENNA RESISTANCE—10 to 1000 ohms as ordered.

ANTENNA REACTANCE—Plus J 600 to minus J 300 ohms from 540 to 1000 kc. Plus J 600 to minus J 500 ohms above 1000 kc.

CIRCUIT—Tee network.

METERING—Option of 3" or 4" meters according to design. If expanded scales are desired, so state when ordering. Slight extra cost for expanded scale meters.

REMOTE METERING—Provision made for either thermocouple or diode type as listed on other pages of this catalog (see Index).

SHIPPING WEIGHT—Varies slightly with frequency. ACU-11 approximately 300 lbs., ACU-12, 375 lbs.

ORDERING INFORMATION—Give line impedance, tower measurement data, if known, tower height, and frequency of operation.

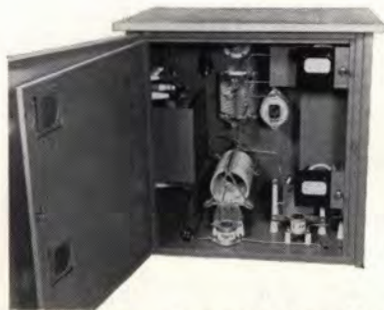

Antenna Coupling Units for 5 kw broadcast transmitter. Cat. ACU-11
Antenna Coupling Units for 10 kw broadcast transmitter. Cat. ACU-12

Complete Tower Termination Equipment

(Model 47A — up to 1250 Watts)

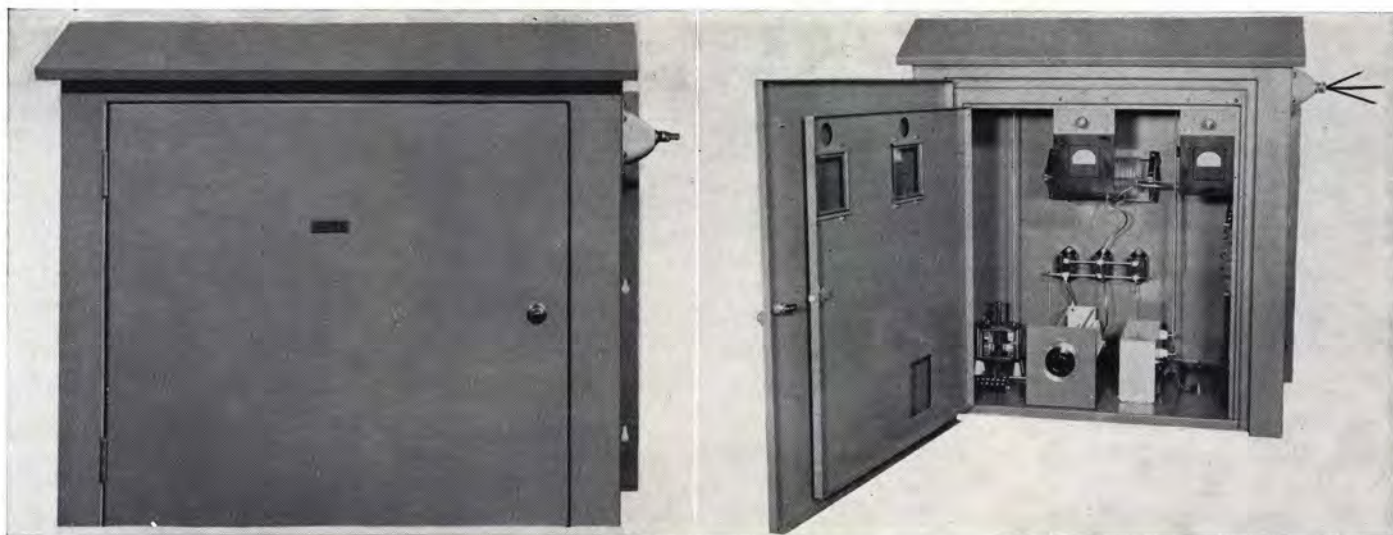

FOR broadcast stations up to 1000 watts, the Gates 47A tower termination equipment incorporates everything necessary at the base of the tower. This includes all antenna coupling equipment plus tower lighting choke coils and diode type remote metering equipment, including remote meter for use at the transmitter.

The cabinet is constructed of heavy cold rolled 16 gg. steel, resistance welded, and prime and finish coated. Fitted therein is a Tee network coupling system which will (as ordered) match any transmission line from 50 to 360 ohms, and any antenna impedance from 25 to 1000 ohms. Two meters are supplied, each with associated meter shorting switch for line current and antenna current. A third meter is supplied to be used at the transmitter for remote antenna current indication. The remote meter operates from a diode type rectifier which is part of the 47A equipment. Coupling of the diode unit to the antenna is inductive for full lightning protection.

Additionally provided is a 3-section solenoid design tower light isolation choke coil with appropriate capacitors. This is the Gates MO-3936 choke listed elsewhere in this catalog (see Index). All parts are conservatively rated, and this equipment may be used with any transmitter up to 1000 watts (fully modulated). Size 39" high, 36" wide and 30" deep.

SPECIFICATIONS

FREQUENCY—540 to 1700 kc.

CARRIER POWER—1250 watts or less.

INPUT IMPEDANCE—50 to 360 ohms.

CIRCUIT—Tee network.

ANTENNA RESISTANCE—25 to 1000 ohms.

ANTENNA REACTANCE—Plus J 600 ohms to minus J 300 ohms from 540 to 1000 kc. Plus J 600 ohms to minus J 500 ohms above 1000 kc.

LIGHTNING PROTECTION—Meter shorting switches for both line and antenna meters plus inductively coupled diode type remote meter.

SHIPPING WEIGHT—250 lbs.

ORDERING INFORMATION—State line impedance, frequency of operation, height of tower, height of tower insulator above ground, and operating power.

Tower Termination Equipment, complete. Cat. No. 47A

Remote Antenna Meters

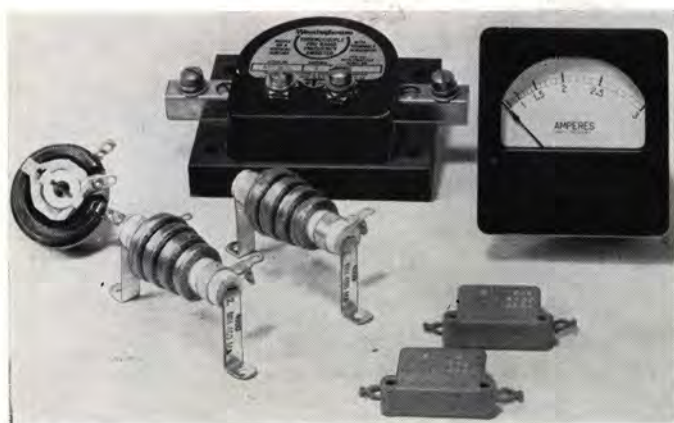

THERMOCOUPLE TYPE

A complete kit, including adjusting rheostat, isolating choke coils, mica capacitors, thermocouple, and either 3" or 4" square case meter. Electrical design is such that a rheostat adjusts the reading to duplicate that of the tower meter, although the remote meter may be supplied by a line up to several thousand feet in length. The meter contains a 100 micro-ampere movement. Diagram illustrates method of installations.

- With 3" meter 0-3 R. F. Amps. **Cat. M-3383**
- With 3" meter 0-5 R. F. Amps. **Cat. M-3133**
- With 3" meter 0-10 R. F. Amps. **Cat. M-3386**
- With 3" meter and blank scale. **Cat. M-3931**
- With 4" meter 0-3 R. F. Amps. **Cat. M-3384**
- With 4" meter 0-5 R. F. Amps. **Cat. M-3385**
- With 4" meter 0-10 R. F. Amps. **Cat. M-3387**
- With 4" meter and blank scale. **Cat. M-3932**
- Rack panel 5 1/4"x19" for 3" meter. **Cat. M-3955**
- Rack panel 5 1/4"x19" for 4" meter. **Cat. M-3956**

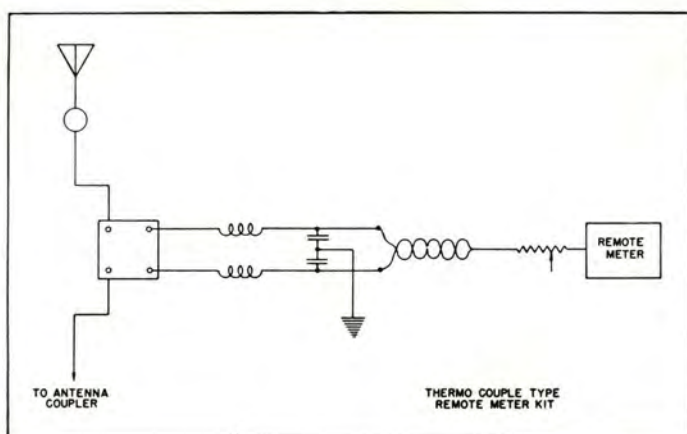

DIODE TYPE

In the diode or rectifier type of remote antenna meter the remote meter is inductively coupled to the antenna lead, and is, thus, excellently protected against lightning or static discharges by elimination of a direct path to the meter. This unit operates from 115 volts, 60 cycles. Variable adjustment is provided so that up to several thousand feet of remote line may be used.

Size, less meter, 8" long, 4 1/8" wide, and 5 3/4" high.

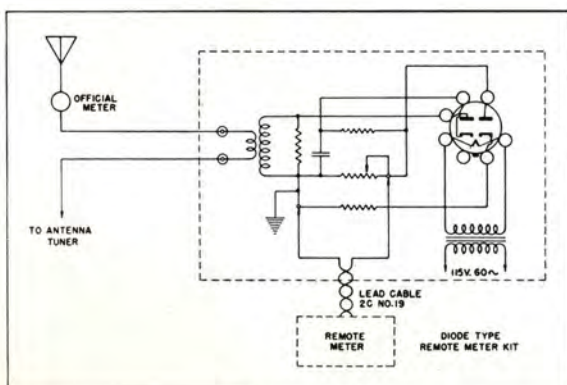

- With 3" meter 0-3 R. F. Amps. **Cat. M-3294**
- With 3" meter 0-5 R. F. Amps. **Cat. M-3294B**
- With 3" meter 0-10 R. F. Amps. **Cat. M-3294D**
- With 4" meter 0-3 R. F. Amps. **Cat. M-3294A**
- With 4" meter 0-5 R. F. Amps. **Cat. M-3294C**
- With 4" meter 0-10 R. F. Amps. **Cat. M-3294E**

NOTE—If panels desired, use those listed under thermocouple type. Diode meter may also be purchased with blank scale, if desired.

If You Didn't Get This From My Site,
Then It Was Stolen From...

Rack Cabinets



OPEN SIDE RACK CABINETS

This cabinet is widely used and will mechanically and symmetrically match several competitive makes. Designed around an open frame as the basic unit, the sides, shields, door and trims are supplied separately and purchased as requirements dictate. Basic frame includes 2 panel mounting angles, 2 terminal board mounting angles, rear door and hardware. Other accessories are listed below. Size: 84" high, 22" wide, 18" deep. Panel mounting space 77"x19". Depth including rear door (closed) 21 $\frac{1}{8}$ ". Door swung 23". Width with two SP1 side panels 28". Single trim is for each front corner. Double trim is for joining one cabinet to another at the front. Shields are to electrically separate cabinets fastened together. Two SH1 and one SH2 required for complete top to bottom electrical shield.

- RAK1** Basic Rack. Code ZIEVS.
- SH1** Large Side Shield. Code ZIEWT.
- SH2** Small Side Shield. Code ZIFAB.
- SP1** Side Panel. Code ZIFBA.
- TRM1** Single Corner Trim. Code ZIFCE.
- TRM2** Double Trim. Code ZIFEC.
- BRK1** Terminal Board Mtg. Bracket. Code ZIFFD.



SOLID SIDE RACK CABINETS

A heavily built deluxe cabinet for all applications. Matches all Gates transmitters in symmetry and color. Made of heavy cold rolled furniture steel, resistance welded and finished in glossy gray. (Special colors on request.) Size: 78" high, 23 $\frac{1}{2}$ " wide, 20 $\frac{1}{2}$ " deep. Panel space 71 $\frac{3}{4}$ " x 19". Full size rear door. Tapped for 12/24 machine screws. TRM3 double trim strip is for joining two cabinets as illustrated to the right.

- Model DM1X Rack Cabinet.** Code ZIEGD.
- Model TRM3 Double Trim.** Code ZIELJ.



Audio Terminal Block

Provides 80 terminals for connection of inter-rack wiring to base of cabinet. A standard PBX item.

- Model 46 Terminal Block.** Code ZIEMK

Power Terminal Block

A heavy barrier type terminal board designed to accommodate AC wiring termination. Has 12 terminals. Has provision for indicator strip.



- Model CDM12 Terminal Block.** Code ZIERP.

Waist High Rack Cabinets

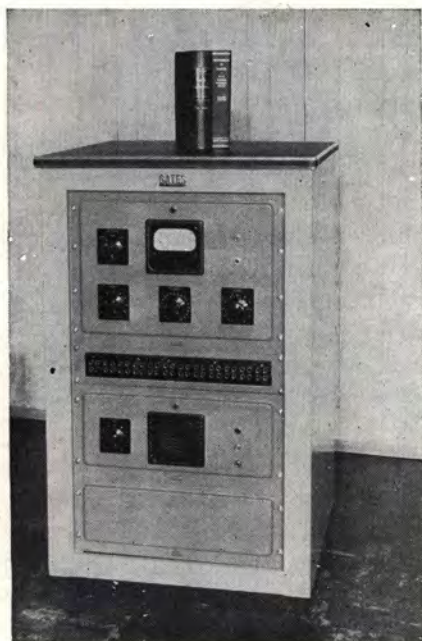

Above, single unit waist high cabinet with linoleum top.



Double unit waist high cabinet shown above with double linoleum work top.

Studio control room audio installations are often surrounded by glass windows which allow the operator eye level vision into adjoining studios. The waist high rack cabinet was designed by Gates to make full use of wall space under such windows. Likewise, windows in transmitter buildings occupy a generous amount of space and waist high cabinets may be used to similar advantage.

Waist high cabinets are manufactured in single units and may be bolted together in any desired

quantity. They are available with or without linoleum worktops, the former so that the cabinets may also serve as a table, which is always desirable in control rooms for sorting transcriptions, processing tape, etc. Cabinet is of heavy cold rolled furniture steel, resistance welded and finished in medium gray. Overall size is $37\frac{3}{4}$ " high, $23\frac{7}{8}$ " wide, and 23" deep. Rack panel space is $19" \times 33\frac{1}{4}"$. Usable depth is 21". A removable back plate is provided. A recessed foot base that fits under the cabinet is available as an accessory. Size $23\frac{1}{4}"$ wide, 19" deep, $21\frac{1}{2}"$ high.

Below, two single waist high units with triple linoleum top allowing foot room in center.



Linoleum tops are an added accessory. Made of 5-ply seasoned plywood and covered with heavy black dull finish linoleum, trimmed on all edges with chrome molding.

Ordering Data

- Waist high rack cabinet, less base or linoleum top. **Cat. CR-70**
- Base for CR-70 cabinet (optional equipment). **Cat. CR-71**
- Single linoleum top on 5-ply base, for one CR-70 cabinet. **Cat. TR-80**
- Double linoleum top on 5-ply base, for two CR-70 cabinets. **Cat. TR-81**
- Triple linoleum top on 5-ply base, for three CR-70 cabinets. **Cat. TR-82**
- Quad linoleum top on 5-ply base, for four CR-70 cabinets. **Cat. TR-83**

NOTE—Tops required only where top of cabinet is used for work space. Cabinets have metal tops. CR-71 base usually purchased for one cabinet only. If two or more cabinets are installed side by side, we suggest a common wood base (or no base at all).



**Communications
Equipment**



5000/10,000 Watt 2-22 MC Transmitters

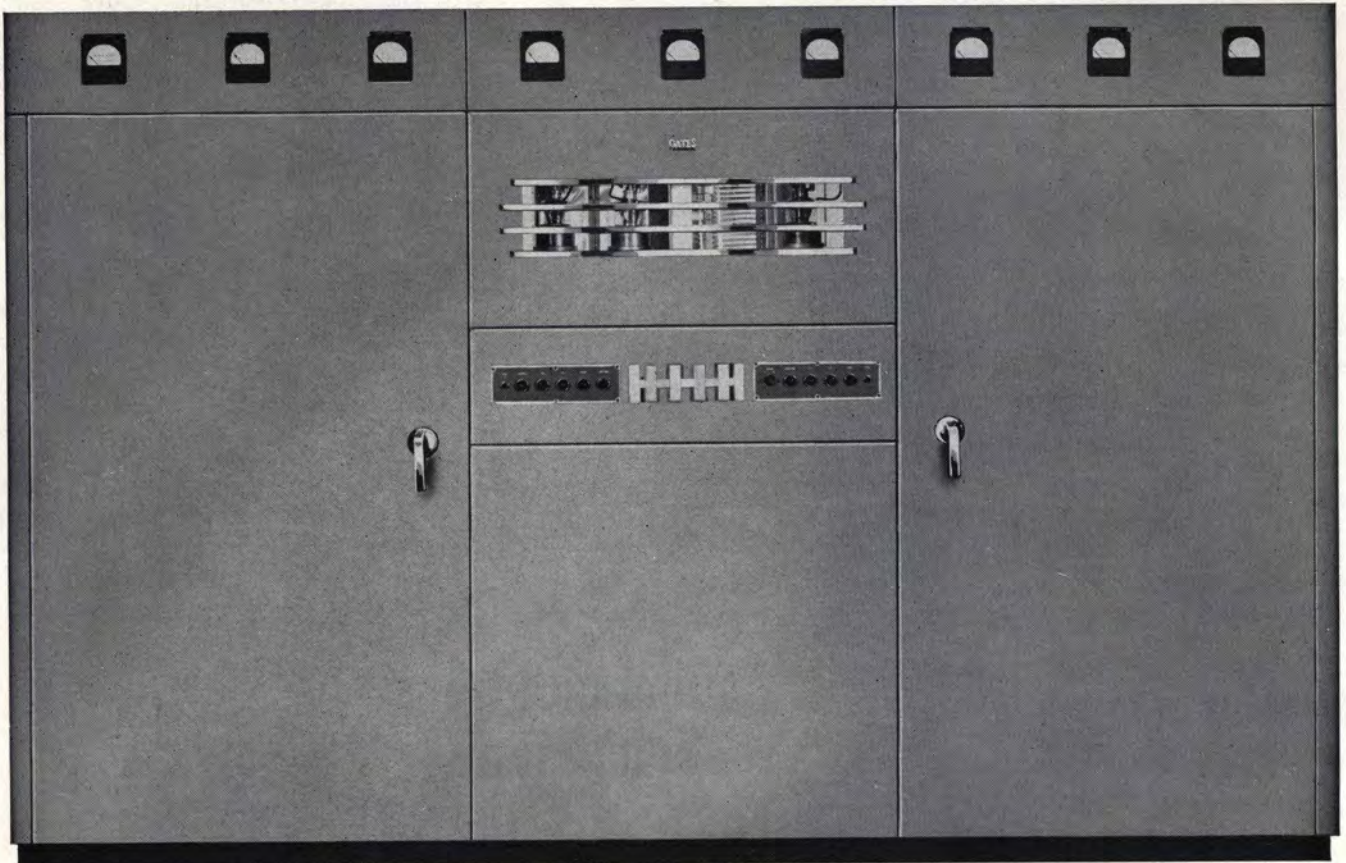

**New and Modern High Frequency Transmitters for 5 kw and 10 kw,
available in several models for telephone, telegraph
and broadcast service.**

These excellent Gates transmitters have already established an enviable reputation in both private and government communications throughout the world. — Designed to operate in world-wide climates and for the rigorous demands of continuous duty. — Available in ten models to fit all requirements of voice or broadcast quality, telegraph only, or combinations of modulated and high speed CW service.

Carrier frequency change may be made in a matter of seconds by a combination of continuously variable tuning plus “latch on” tank coil assemblies. — New tube complement means lower tube cost and longer tube life.

Every modern innovation known has been applied to the design of these fine Gates transmitting power plants. Though up to the minute in design, Gates engineers have omitted any mechanical arrangements that are difficult to service, repair or maintain. Gates HF-5 and HF-10 series high frequency transmitters are rugged, heavily built, straightforward designed equipments that will please a world-wide engineering clientele.

5 AND 10 KW SHORT WAVE TRANSMITTERS

MODELS AVAILABLE for 5 and 10 kw service are listed on Page 70. Whether the need is for voice quality modulation, broadcast quality, telegraph or combinations of telegraph and telephone, you will find a model exactly as required. Telegraph models will key with perfect square top wave form up to 400 WPM, and excellently up to 600 WPM. Frequency shift keying is adaptable to all models.

TUBE COMPLEMENT is shown on Page 71 and in the block diagram on Page 72. Particular note should be made of the 3X2500F3 tubes used in all models in the radio frequency and modulator stages. These low cost, long life tubes mean much in high operating efficiency and low hourly operating cost.

BAND CHANGING is quick and effective. All circuits are continuously variable and tuned from the front panel—with exception of the final tank coil. The Gates "latch on" system allows fast changing of this coil and completely eliminates complicated and costly tuning mechanisms. Four final tank coils are provided (see Page 70) to cover the range from 2 to 22 megacycles. Pi-network tuning is also continuously variable.

AUDIO has four stages, with abundance of drive and modulation capacity. Broadcast models employ both modulation transformer and reactor, while voice models are equipped with the new and exclusive Gates designed Hi-cap modulation transformer. This eliminates the modulation reactor—and yet, adds to modulator efficiency at voice frequencies.

POWER SUPPLIES are generous in both size and number. Main supply is full wave, three phase,

utilizing either six 8008 or 673 tubes, depending on model selected. Separate supplies are incorporated for low voltage and bias circuits. No combination filament transformers will be found in these transmitters, i. e., no more than one secondary winding to a transformer.

PROTECTIVE DESIGN is very complete. It includes primary circuit breakers in all major circuits and individual supervisory relays in all overload circuits such as RF driver, audio driver, final amplifier, modulator, air failure and exciter failure. Time delay, door interlock and pressure type blower air interlock protective equipment are all standard equipment.

RECYCLING is part of the HF-5 and HF-10 transmitter design. If, for any reason, the carrier should go off the air, the transmitter will automatically turn itself back on four times. Thus, in case of a static discharge, such as across the base of a tower, the transmitter will automatically turn back on.

COOLING is provided by one large squirrel cage blower which sends a torrent of air to the four 3X2500F3 tubes—with excess air blowing into the transmitter proper. A diaphragm air pressure switch protects the tubes against air failure, and even a clogged air filter will activate the diaphragm pressure switch. An additional small blower feeds a small stream of air on the base of each high voltage mercury vapor rectifier tube.

LOADING from the push-pull power amplifier is balanced and will match from 300 to 800 ohm lines. Veeder counter dials on the variable pi-network coils allow accurate logging for frequency change.

Below illustrates the RF power amplifier. Note slides extending from sockets to accommodate "latch on" tank coil assembly. Variable vacuum condensers handle final tank tuning.

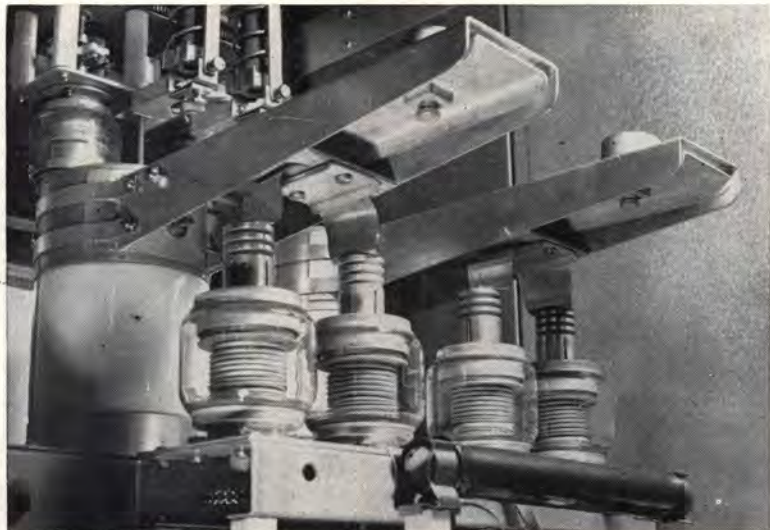

GATES 5 AND 10 WATT 2-22 MC TRANSMITTERS

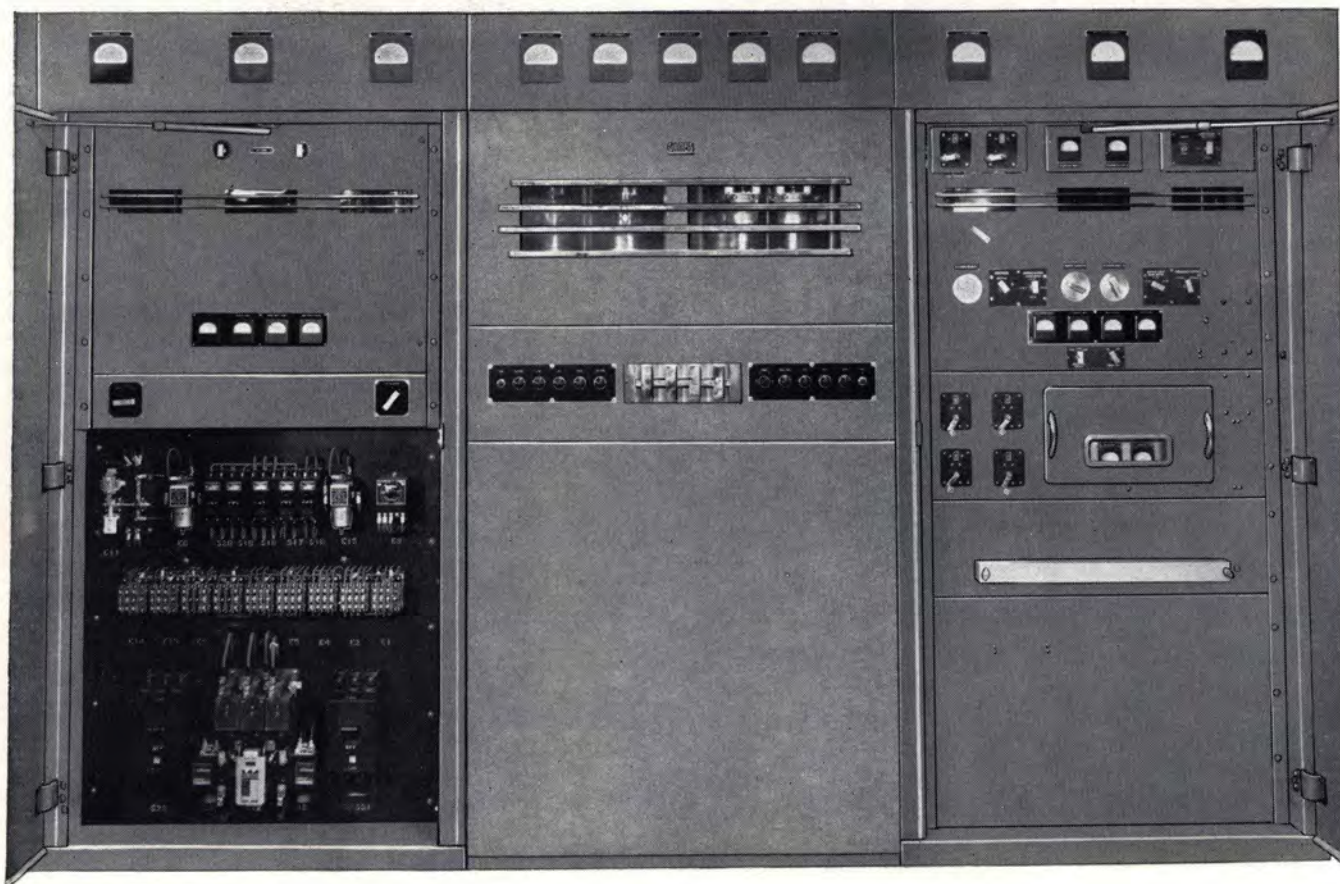

Front of Gates HF-5 and HF-10 transmitters with doors removed. Note massive relay protection to left. Transmitter is in three cubicles which bolt together. Wiring between cubicles is by jumpers between terminal boards, and time consuming "on location" cabling is eliminated.

Below: two rear views of the left radio frequency driver cubicle, illustrating clean and roomy design. Right illustration is rear of audio/rectifier cubicle. Note predominance of ferrule resistors, and that transformers are fully cased for humidity protection. Center cubicle is illustrated on opposite page.

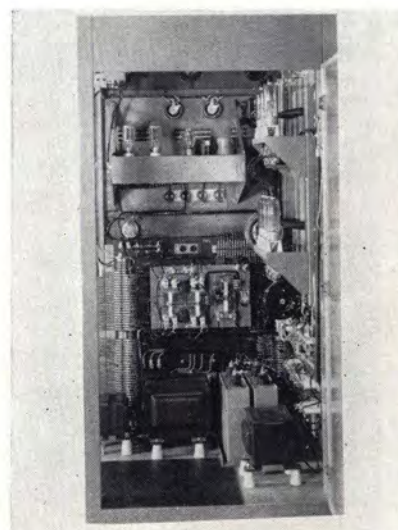
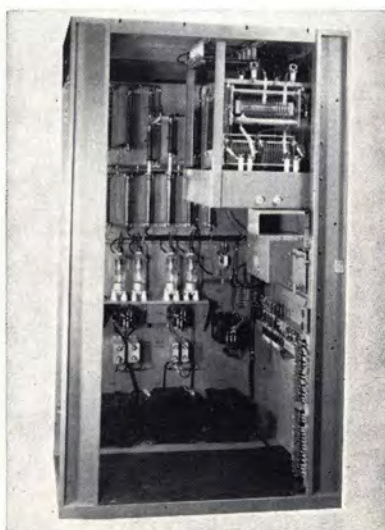
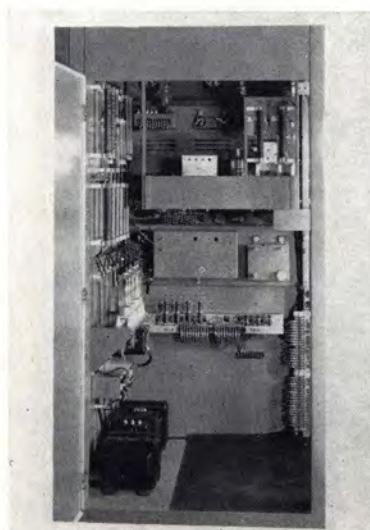

5000 AND 10,000 WATT TELEPHONE/TELEGRAPH TRANSMITTERS

Construction

All models consist of three cubicles or cabinets which bolt together easily after unpacking. At the bottom of each cubicle are large barrier terminal strips which transfer the wiring from cubicle to cubicle, eliminating any cabling after receiving. Full size front and back doors are provided for the two outside cubicles. Layout design is such that the attendant may walk inside the back—rubber mats are provided. Such refinements as automatic internal lights that turn on when the back door is opened, and utility receptacles for drop cords or soldering iron are standard equipment.

Floor space for the three cubicles or entire transmitter is 125" wide and 49" deep, exclusive of door swing. The floor plan at bottom of page gives additional detail. Broadcast and voice models have external modulation transformer, reactor and power transformer as shown at bottom of Page 71. Telegraph models have the power transformer self-contained in the left cubicle. The rugged construction is best emphasized in the numerous illustrations from Pages 66 through 71. Heavy cold rolled furniture steel, both resistance and seam welded, with more than ample re-enforcing, is fabricated into the elaborate cabinet section of these Gates transmitting plants. Cabinet is prime coated, then hot sprayed, after which it is hand rubbed. Standard color is gray. All hardware is in chrome, nickel or natural brushed aluminum. Design meets regulations of all countries under the heading of "good engineering practice."

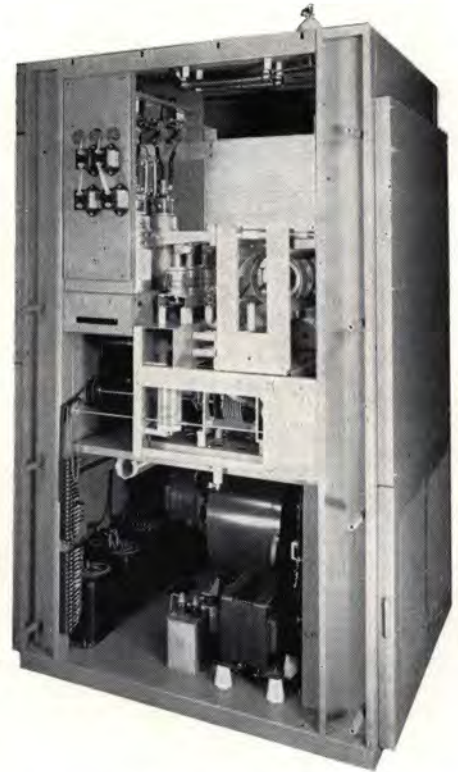

This unusual illustration of the center cubicle shows RF power amplifier with "latch on" tank coil in place, and variable pi-network coils underneath. Note large blower at bottom with double air intake filters.

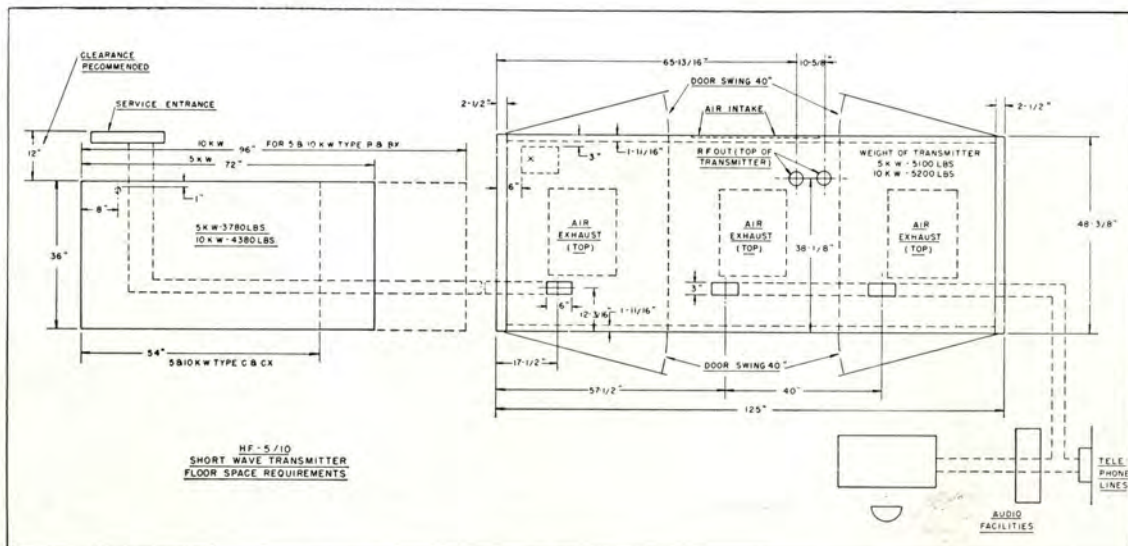

Floor plan shows location and size of transmitter and external modulator/power components, where used in voice models. External components may also be mounted in basement or in out-building if desired.

HIGH FREQUENCY TRANSMITTERS, 5 AND 10 KW

Ten Models To Select From —

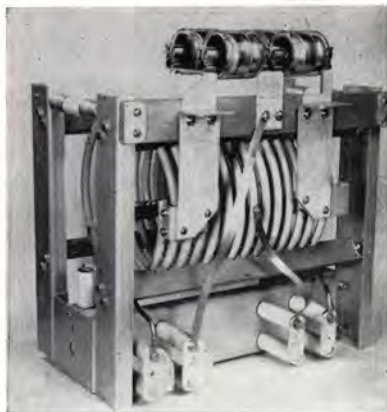

HF-5B, a 5000 watt high frequency broadcast transmitter employing high level modulation, operating from 2-22 mc with uniform audio frequency response within 2 db from 30 to 10,000 cycles. Employs 3X2500F3 tubes as power amplifiers and Class B modulators, providing both better performance and economy in tube cost.

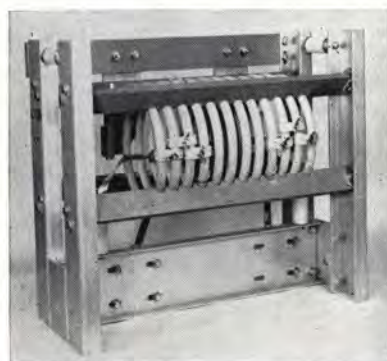

HF-10B, identical in all respects to the HF-5B but providing 10,000 watts output from 2-22 mc with high level modulation and uniform audio frequency response within 2 db between 30 and 10,000 cycles. For international radio broadcasting at high frequencies, no finer 10,000 watt equipment has ever been constructed. Uses the famous 3X2500F3 tubes with thoriated tungsten filaments in both power amplifier and modulator sockets.



HF-5BX, the same transmitter as the HF-5B, for high frequency international broadcasting but has high speed keyer added so transmitter may be utilized for both high quality telephone and high speed telegraph service.

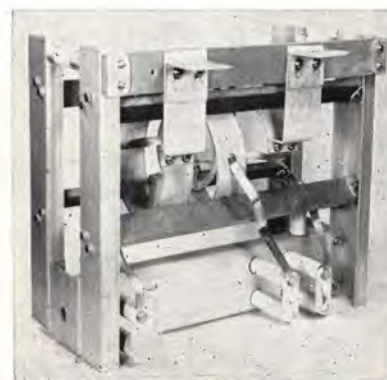

HF-10BX, a 10,000 watt radio transmitter identical to the HF-10B but having added a high speed electronic keyer, providing a high quality 10,000 watt telephone and telegraph transmitter for use between 2-22 mc.

HF-5C, a telephone type communications transmitter similar in all respects to the HF-5B but with the audio frequency portion designed for communications service only. This allows elimination of the modulation reactor and other alterations in audio frequency components, providing economies where only voice communications will be employed and the wide frequency response and extremely low distortion content of the HF-5B is not necessary.

HF-10C, a 10,000 watt communications type telephone transmitter with its audio components designed for voice quality transmission only, and in other respects identical to the HF-10B transmitter. For international telephone communications no finer 10,000 watt radio transmitter has ever been constructed.

HF-5CX, an identical transmitter to the HF-5C but with high speed electronic keyer added, providing telephone and telegraph transmission.

HF-10CX, an identical transmitter to the HF-10C but with high speed electronic keyer added and providing a 10 kw telephone and telegraph transmitter.

HF-5TX, a 5000 watt telegraph transmitter only with high speed electronic keying up to 600 WPM.

HF-10TX, a telegraph transmitter producing 10 kw power over a wide band of frequencies between 2-22 mc. The high speed electronic keyer is part of the equipment.

To left is the set of four "latch on" tank coils which cover the entire range from 2 to 22 megacycles. These coils slip into place almost instantly, and latch down with two large knurled screws, completely eliminating complicated and costly tuning mechanisms.

5 AND 10 KW TELEPHONE, TELEGRAPH AND BROADCAST (2-22 mc Transmitters)

SPECIFICATIONS

TUBES (all models)—One 812; Two each 6L6, 4-125A, 6J7. Three each 807. Four each 845; 3X2500F3; Ten each 8008.

Note—In 10 kw model, six type 673 replace six type 8008 in main rectifier. In telegraph model, delete two each 6J7, 807, 3X2500F3, and four 845. Where keyer not employed, delete 812.

METERING—Individual meters provided for: Oscillator plate, First Int. Amp. Plate, Second Int. Amp. Grid, Second Int. Amp. Plate, Third Int. Amp. Grid, Third Int. Amp. Plates (2 meters), Power Amp. Grid, Power Amp. Plates (2 meters), First Audio Plates, Second Audio Plates, Third Audio Plates (2 meters), Modulator Plates (2 meters), Filament Volts, Plate Volts. (Telegraph models have audio meters omitted.)

FREQUENCY RANGE—2-22 mc.

POWER OUTPUT—Model HF-5 (all models), 5000 watts carrier.

Model HF-10 (all models), 10,000 watts carrier.

Note—Under certain circumstances power output above 18 mc will be slightly lower.

OUTPUT IMPEDANCE—300-800 ohms balanced.

FREQUENCY STABILITY—0.005%.

CRYSTAL POSITIONS—4 (additional crystal provisions available on special order).

AUDIO INPUT—600 ohms; plus 14 dbm for 5 kw; plus 17 dbm for 10 kw.

FREQUENCY RESPONSE—Plus or minus 1.5 db, 30-10,000 cycles broadcast model; Plus or minus 3 db, 150-4000 cycles communications model.

DISTORTION—3% or less all frequencies between 50 and 7500 cycles for broadcast model; 10% or less between frequencies of 150 and 4000 cycles for communications model.

NOISE—60 db or better below 100% modulation, broadcast model; 45 db or better below 100% modulation, communications model.

POWER CONSUMPTION AT 100% MODULATION—HF-5B, HF-5BX, HF-5C, HF-5CX, approximately 19.5 kw. HF-10B, HF-10BX, HF-10C, HF-10CX, approximately 31 kw. HF-5TX, approximately 10 kw. HF-10TX, approximately 20 kw.

KEYING SPEED—400 WPM with pure square top wave form. Higher practical keying speeds up to 600 WPM easily possible.

SIZE—125" long, 78" high, 49" deep, with door swing front and back doors 40". Size of largest cubicle 51" wide, 56" deep, 80" high. Space required for external transformers, where used, 36" wide, 72" long, 36" high.

NET WEIGHT—5 kw telephone models, 9,600 lbs.

10 kw telephone models, 12,000 lbs.

GROSS WEIGHT—5 kw telephone models, 13,900 lbs.

10 kw telephone models, 15,100 lbs.

CUBAGE—5 kw models, 317 cu. ft.; 10 kw models, 342 cu. ft.

ORDERING NOMENCLATURE

By Catalog Number

MODEL HF-5B complete 5 kw broadcast model, high frequency transmitter with complete coil set 2-22 mc, one set of tubes, less crystals and ovens.

MODEL HF-10B complete 10 kw broadcast model with all coils 2-22 mc, one set of tubes, less crystals and ovens.

MODEL HF-5BX complete 5 kw broadcast model, same as above but with electronic keyer added, with tubes, complete coil set 2-22 mc, less crystals and ovens.

MODEL HF-10BX complete 10 kw broadcast model with electronic keyer added, with tubes, complete coil set 2-22 mc, one set of tubes but less crystals and ovens.

MODEL HF-5C communications telephone transmitter, 5000 watts, with coil set 2-22 mc, complete set of tubes but less crystals and ovens.

MODEL HF-10C communications type telephone transmitter, 10,000 watts, with complete coil set 2-22 mc, complete set of tubes but less crystals and ovens.

MODEL HF-5CX communications telephone and telegraph transmitter, 5000 watts power, with electronic keyer, complete coil set 2-22 mc, complete set of tubes but less crystals and ovens.

MODEL HF-10CX communications telephone and telegraph transmitter, 10,000 watts power, with electronic keyer, complete coil set 2-22 mc, complete set of tubes but less crystals and ovens.

MODEL HF-5TX telegraph transmitter only, 5000 watts, with complete coil set 2-22 mc, high speed electronic keyer, complete set of tubes but less crystals and ovens.

MODEL HF-10TX telegraph transmitter only, 10,000 watts, with complete coil set 2-22 mc, complete set of tubes but less crystals and ovens.

MODEL HFXT-1 crystal and oven ready to use with any of above transmitters. Specify carrier frequency desired when ordering.

MODEL HFTSB-5 complete 100% tube set for 5 kw telephone models.

MODEL HFTSB-10 complete 100% tube set for 10 kw telephone models.

MODEL HFTSX-5 complete 100% tube set for 5 kw telegraph models.

MODEL HFTSX-10 complete 100% tube set for 10 kw telegraph models.

MODEL HFK tube set for electronic keyer.

ORDERING INFORMATION

When ordering please give every detail possible, such as operating frequency or frequencies, line impedance, power line frequency and altitude of installation. Transmitters are normally carried in stock. When ordering do not overlook spare tubes and crystals, if these are desired. Both equipment and base spare parts lists will be supplied for your selection on request.

SPECIAL MODELS

Gates engineers have endeavored to incorporate in these transmitters every engineering achievement you might desire. It is recognized that various primary voltages and frequencies exist in different parts of the world. Also, slight modifications to the standard specifications may be required in certain instances. If this is necessary, the modifications will be included for a modest increase in price.

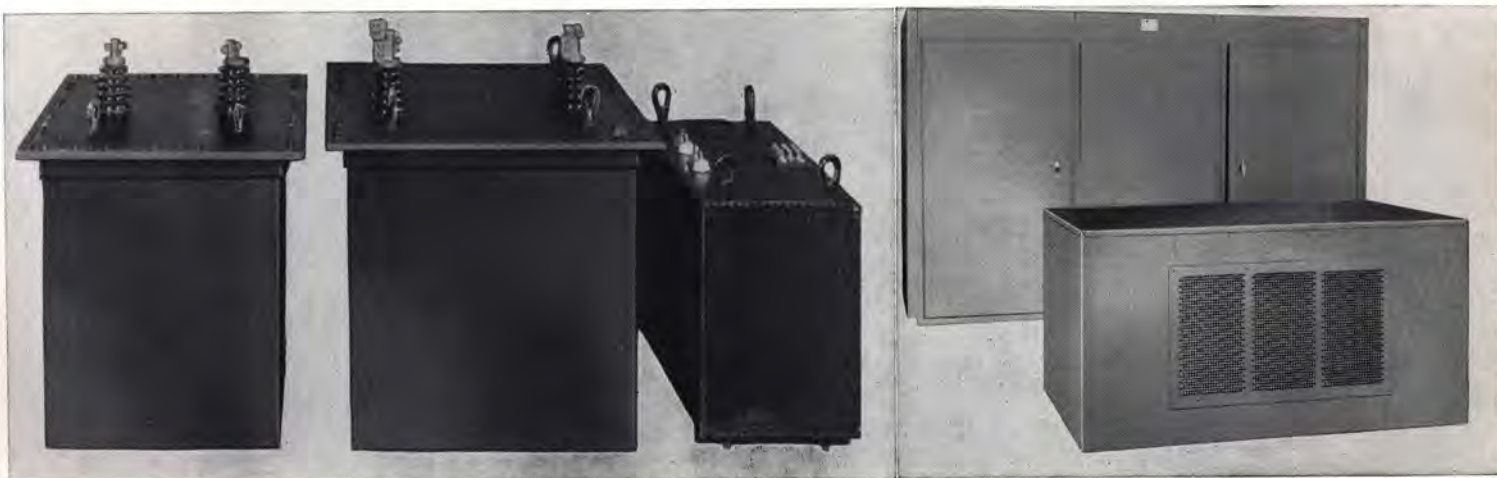

Above is a typical set of external components for the HF-5B or HF-5BX transmitter. Where desired, an enclosure may be obtained to cover these components, as illustrated at the right.

GATES HF-5 AND HF-10 SHORT WAVE TRANSMITTERS

(See preceding 5 pages for detail)

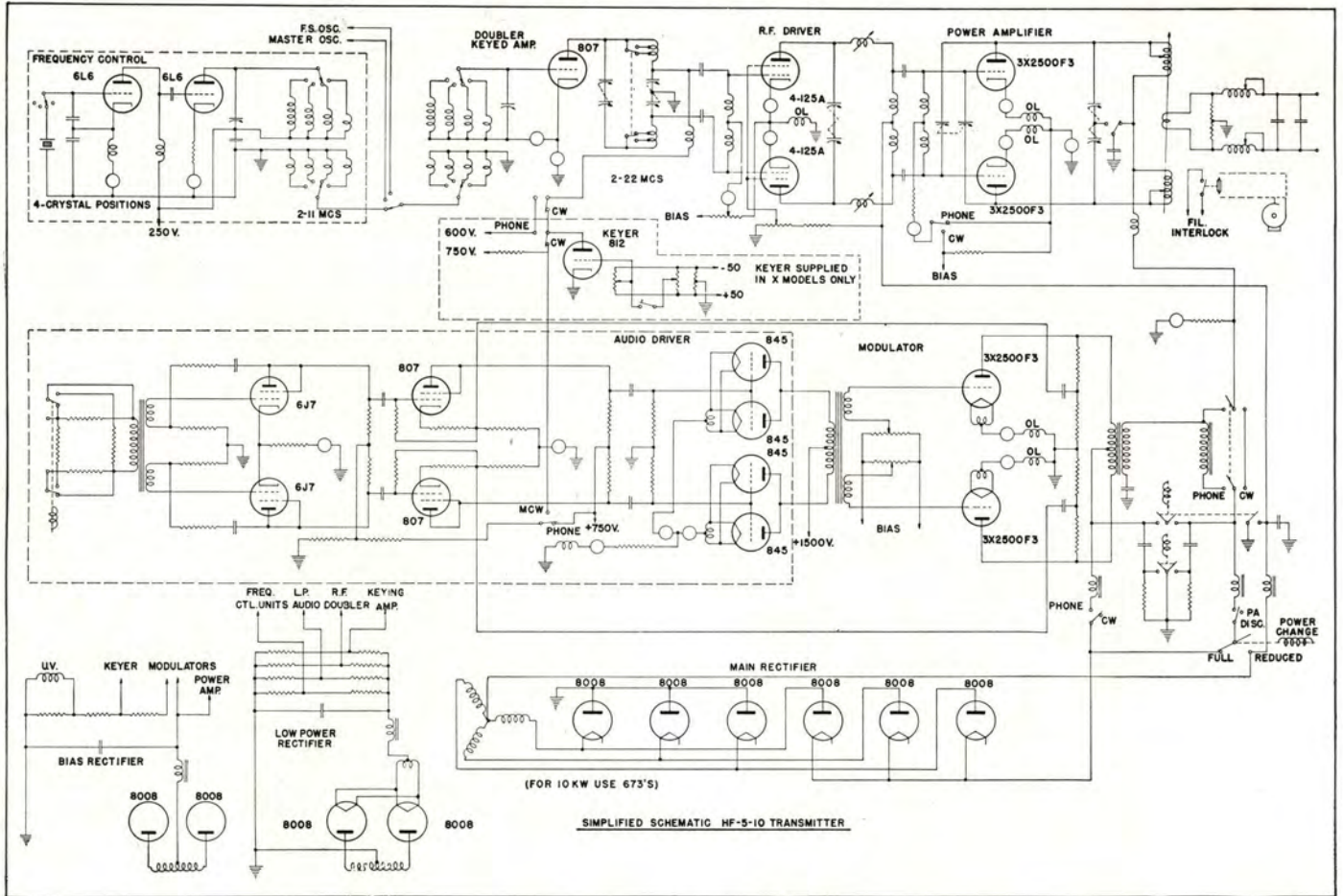

Below, duplicate HF-10TX 10,000 watt telegraph transmitters installed at Press Wireless, Inc., Hicksville, L. I., New York.

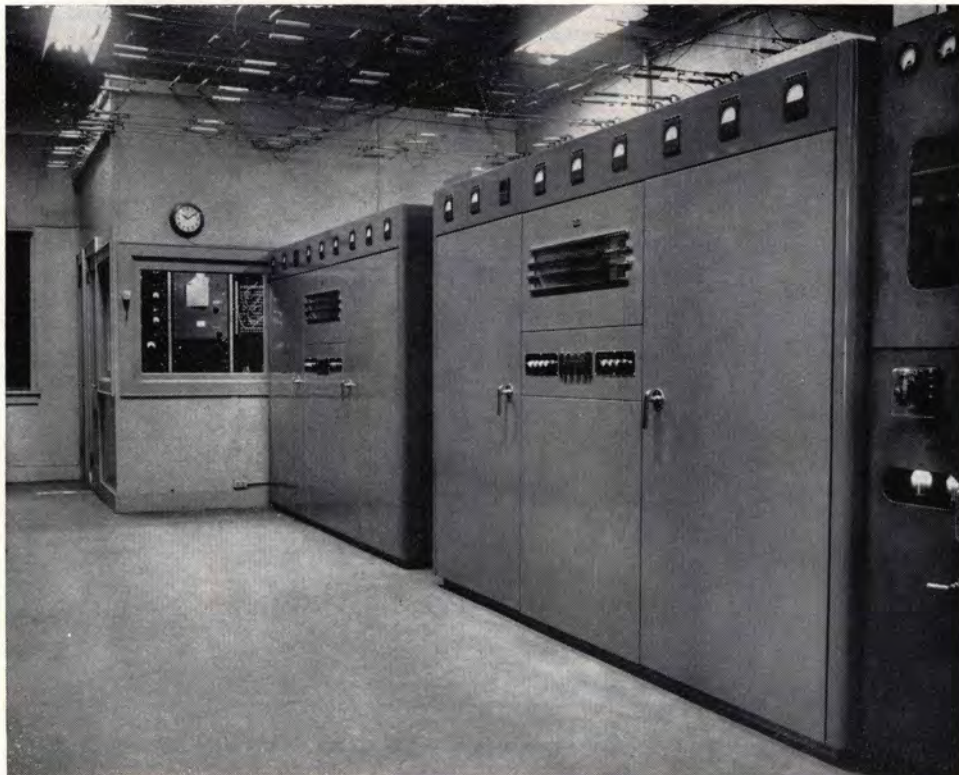

If You Didn't Get This From My Site,
Then It Was Stolen From...

GATES

1000 WATT TELEPHONE, TELEGRAPH AND BROADCAST TRANSMITTERS

FOR 2-22 MC OPERATION

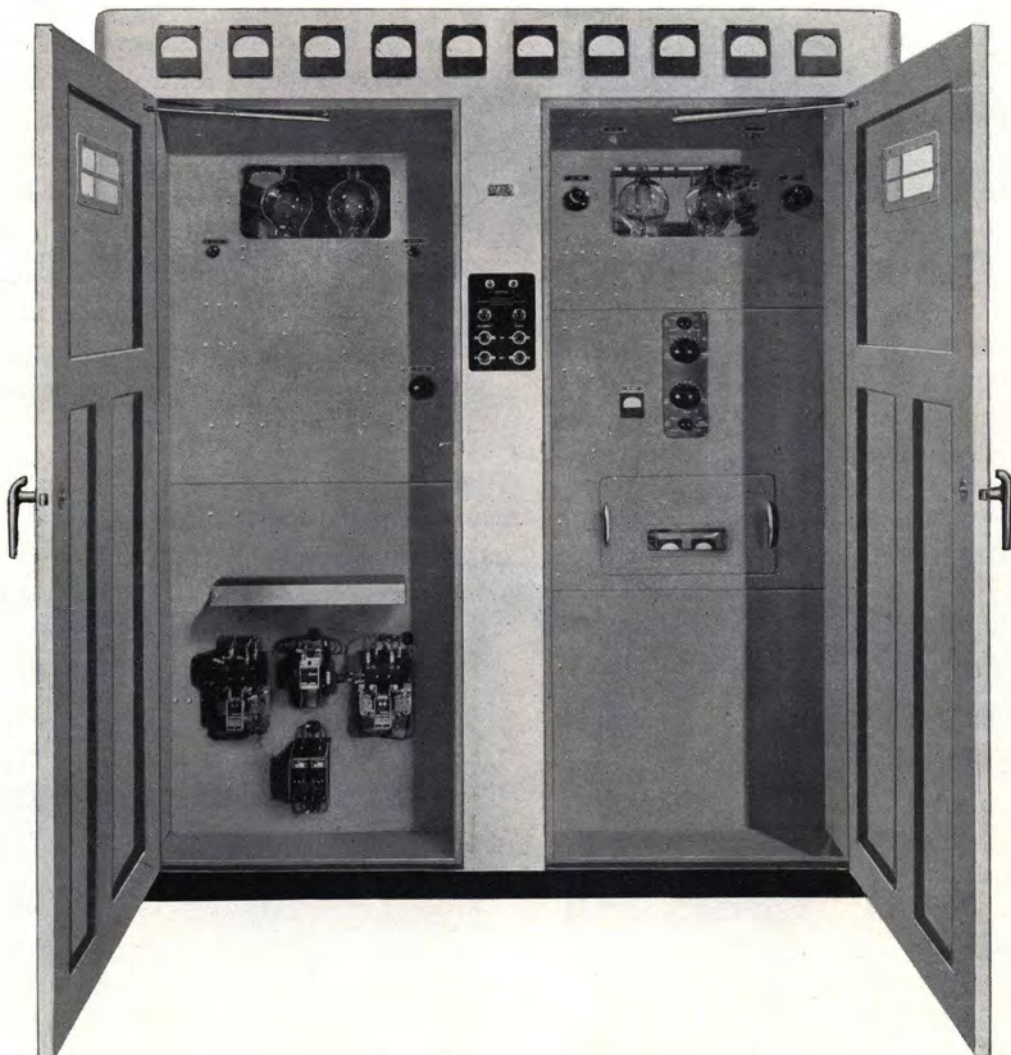

Three models of 1000 watt (carrier) transmitters are offered to those who desire the very finest in short wave equipment. A model for short wave broadcasting, a second model for voice and telegraph communications and a third model for telegraph only. The several following pages fully describe these quality filled radio transmitters.

1000 Watt Telephone and Telegraph Transmitters

In the field of heavily built, continuous service, commercially built 1000 watt high frequency transmitters, there is nothing that will equal the new line of Gates HF1 transmitters. — Large in size to hold large components that will operate 24 hours daily, year-in and year-out. — Complete in equipment complement to assure nothing left wanting in handling tough schedules—and modern right up to the last minute with advanced engineering.

Operation is continuously variable from the front panel, other than the final tank circuit which employs plug-in coils. Frequency change may be made within seconds. Four radio frequency stages, four audio stages and four power supplies, along with rugged

circuit protection in the most complete relay system ever used in a 1000 watt equipment, add to the reliability expected in commercial equipment.

There are 13 meters in all, ten of which are 4 inches. Full size front doors prevent brushing against exposed controls. Ventilation is by means of a large squirrel cage blower with filtered air intake. Entirely new, clean, fresh air is sent to every part of the transmitter each 15 seconds. — Engineers who follow a plan of carefully selecting transmitting equipment on the basis of reliable performance and more operating features will, indeed, want to seriously consider the Gates HF1 series.

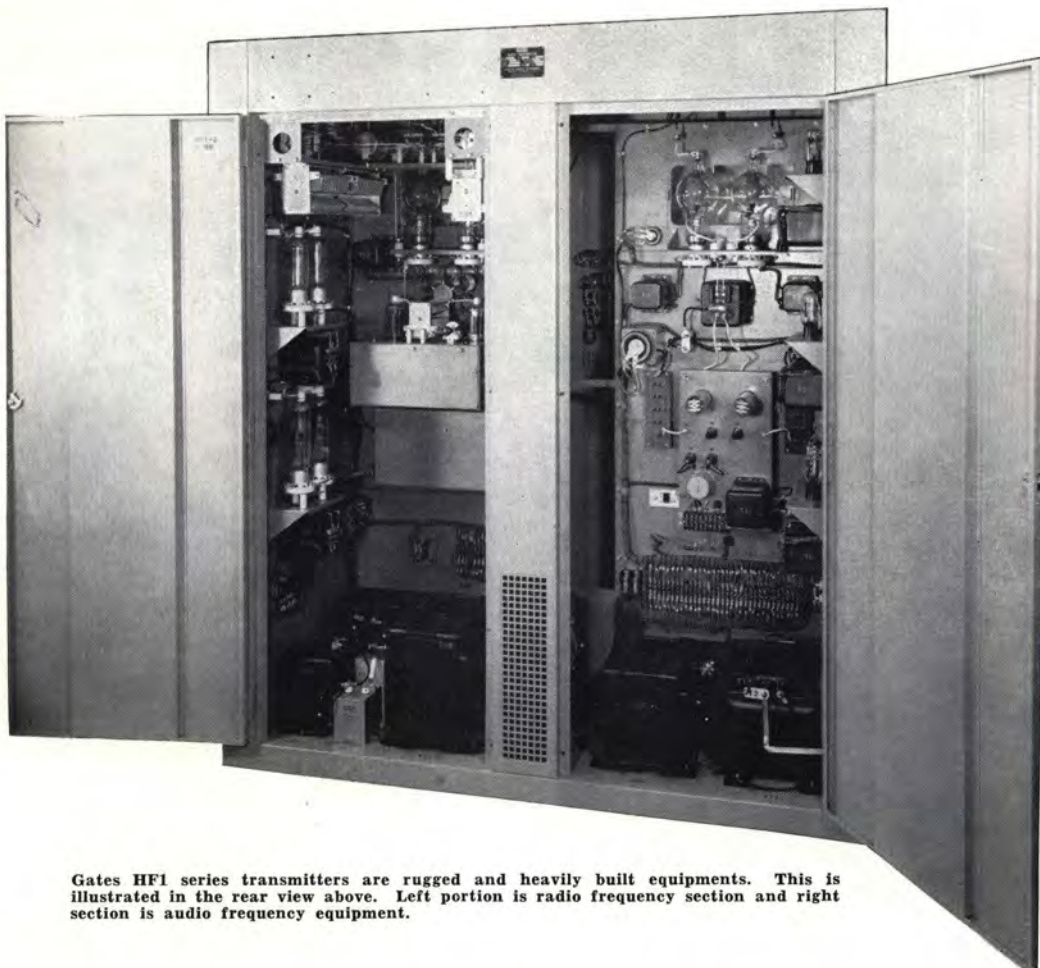

Gates HF1 series transmitters are rugged and heavily built equipments. This is illustrated in the rear view above. Left portion is radio frequency section and right section is audio frequency equipment.

— For Communications or Broadcast Service

There is no substitute for rugged and heavy design where around-the-clock press copy or important voice and telegraph communications are concerned. This is certainly true, also, in eighteen to twenty-hour daily short wave broadcasting.—The Gates HF1 series 1000 watt transmitters will fill these requirements anywhere in the world.

CONSTRUCTION — HF1 transmitters are built into a large and roomy enclosure, having double front and back doors. Directly in the center of this cabinet, or enclosure, is a large squirrel cage blower that changes the air four times each minute. This air blast not only maintains low inner-cabinet temperature, but prevents dust from settling. The air intake is filtered. Cabinet is of 16 gg. and 11 gg. cold rolled steel, resistance and seam welded. It is then zinc chromate primed, after which it is hot sprayed in medium gray and hand rubbed. All hardware is in chrome, nickel and brushed aluminum. Size 72" wide, 33" deep and 78" high, exclusive of door swing.

METERING — Thirteen in all. Ten large 4" meters along the top of the cabinet read not only all necessary voltages and currents, but the additional circuits that make tuning and maintenance easy. Three smaller meters are in the oscillator driver circuit.

PROTECTIVE RELAYS — It is believed that the HF1 transmitters have a more complete relay system than any similar equipment in the 1 kw power range. This complement of relays includes primary circuit breakers, filament and plate contactors, dash pot time delay relay and individual overload relays for RF driver, power amplifier, modulator and audio driver. These relays also activate when rear doors open to expose high voltage.

continued next page

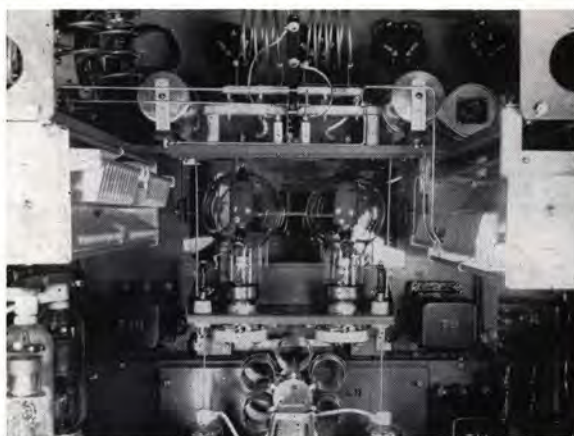

Above, the RF power amplifier showing turret input coils, plug-in tank coils and the pi-network output system.



Front view of the oscillator-buffer section removed from transmitter. One of four crystals may be selected, and may be either temperature or non-temperature controlled.

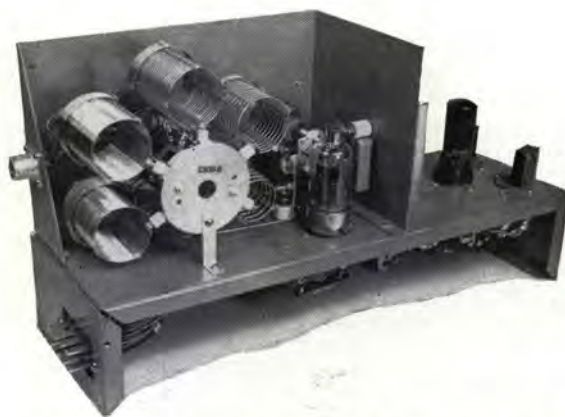

Rear view of oscillator-buffer unit illustrates turret coils for quick band change. Note plug-in oscillator which may be removed quickly for servicing.

HF1 Series 1000 Watt Transmitters

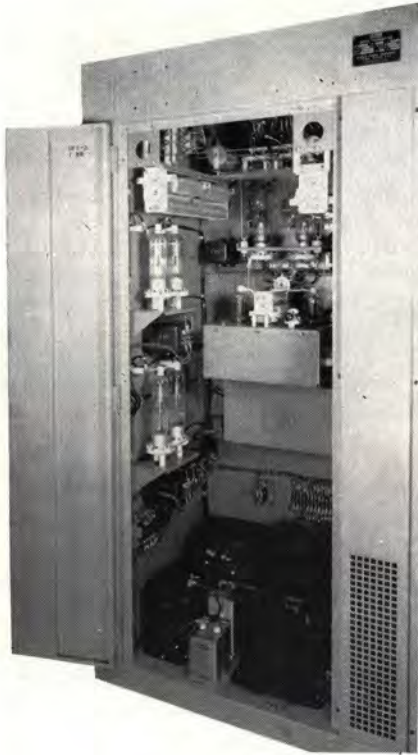

These two rear views of the HF1 transmitter picture the left section of radio frequency portion. The engineer will note the symmetrical design which assures perfect circuit balance, necessary for high efficiency and stability.

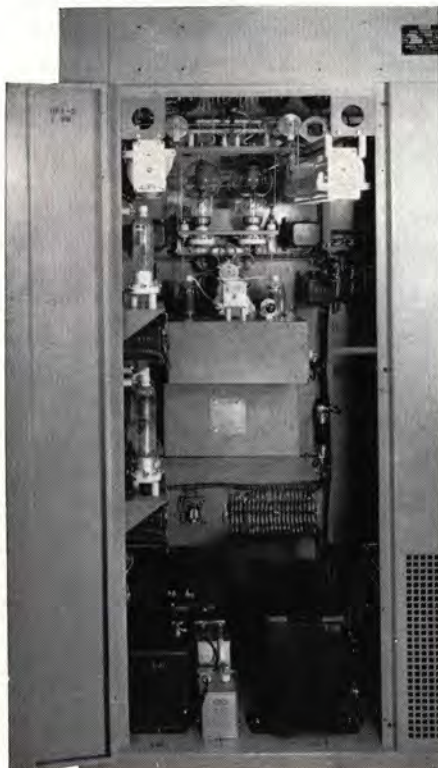

RADIO FREQUENCY DESIGN — The RF portion of the HF1 transmitter has, as the input source, four crystals of either the temperature or non-temperature controlled type. These may be selected from the front panel into the 6AG7 oscillator which excites a 2E26 first amplifier. — The output of the 2E26 tube feeds to push-pull 4-65 tubes, which do not require neutralizing, and supplies an abundance of drive at all frequencies for the push-pull 450TH final power amplifier tubes. Neutralizing of the power amplifier is fixed at all frequencies. RF output is balanced through a pi-network, matching a 300/800 ohm line. Modulation monitor pickup coil is provided.

AUDIO DESIGN — Four push-pull audio stages provide an excess of modulator power for both voice and broadcast models. Voice model uses Hi-cap modulation transformer, emphasizing voice frequencies, while the broadcast model uses linear standard modulation transformer and reactor combined for wide frequency response. Tube complement, all push-pull, is 6J7 first audio, 6J5 second audio, 845 third audio and 450th modulators.

BAND CHANGE — Operation is continuously variable at all frequencies, and in all radio frequency stages except the final power amplifier, for which five sets of plug-in coils are provided—which may be changed instantly. Turret coils, selectable from the front panel, are generously used throughout.

KEYING — The standard transmitter as supplied is for 60 WPM keying; however, it can be supplied for keying up to 400 WPM and for frequency shift keying, as well. Keying is clean and free from chirps or thumps.

POWER SUPPLIES — Five power supplies divide the work load requirements and deliver added reliability. These are: high voltage, intermediate high voltage, low voltage RF, low voltage AF and bias (telephone models only). Primary is 230 volts, 3 wire, single phase, 50 or 60 cycles.

— For Voice, Telegraph or Broadcast

Three Models To Choose From —

HF1-2Y high fidelity broadcast transmitter with full audio frequency response from 30 to 12,000 cycles. Low distortion and noise level make this one of the finest in medium power short wave equipments. Operates from zero level input and is complete, ready to attach to transmission line and studio equipment. Where modulation monitor is desired, see Page 42.

HF-3Y voice quality telephone and telegraph transmitter. This model is identical to the HF1-2Y, other than the audio section. It is designed for best operation between 150 and 3500 cycles—other frequencies have been attenuated. This model may be purchased with frequency shift keyer, listed elsewhere in this catalog, or with 400 WPM keyer. Supplied standard, it keys at 60 WPM. It may be used with the Gates tubeless modulation monitor, listed elsewhere in this catalog.

HF1-XY telegraph transmitter only. This model is also the same as the above models HF1-2Y and HF1-3Y, but has the audio portion removed. It is so built that the audio portion may be added at any later date to complete a telephone or broadcast model. May be purchased with frequency shift keyer, or 400 WPM keyer, if desired. Standard model keys to 60 WPM. When used with properly designed Rhombic antenna, remarkable areas may be covered.

WHAT IS SUPPLIED — Each transmitter is supplied with one complete set of tubes, duplicate instruction books and all necessary materials to make it operative—except the crystals, which are listed separately on the following page (two different types are offered). Speech input equipment to go with the broadcast and voice models will be found listed elsewhere in this catalog; as will antennas, microphones, telegraph keys, frequency shift keyers and anything required for the complete radio station. Transmitters are boxed in solid wood boxes, carefully prepared for either domestic or overseas shipment, as ordered.



The right section of Gates HF1 series transmitter accommodates the entire audio system and intermediate power supplies. In telegraph models the audio system, of course, is not supplied.

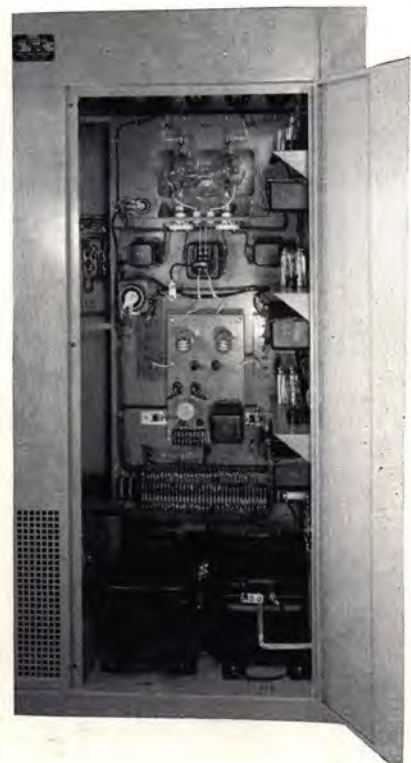

HF1 SERIES 1000 WATT TRANSMITTERS

SPECIFICATIONS

FREQUENCY RANGE—2-22 mc.

CARRIER STABILITY—0.02% with JI-H17 crystal or 0.005% with JKO-2 oven.

NUMBER OF CRYSTALS—4, with two each socket or two per oven as ordered.

POWER OUTPUT—All models 1000 watts CCS (slightly greater for intermittent duty).

POWER INPUT—At 230 volts, 3 wire, single phase, for HF1-2Y or HF1-3Y at average modulation, 4400 watts. HF1-XY telegraph model, 3550 watts.

OUTPUT IMPEDANCE—300 to 800 ohms balanced.

MODULATION MONITOR COIL IMPEDANCE—70 ohms.

FREQUENCY RESPONSE—HF1-2Y 30-12,000 cycles $\pm 1\frac{1}{2}$ db.

HF1-3Y 100-3500 cycles ± 2 db.

DISTORTION—3% or less 100-7500 cycles for HF1-2Y.

10% or less 100-3500 cycles for HF1-3Y.

NOISE—60 db below 100% modulation—Model HF1-2Y.

48 db below 100% modulation—Model HF1-3Y.

AUDIO INPUT—0 db at 600 ohms.

KEYING—60 WPM as standard. Electronic keyer available for 400 WPM at slightly added cost. Also adaption for FSK at no additional cost where stated.

SIZE—78" high, 72" wide, 33" deep. Door swing, front and back, 26".

SHIPPING WEIGHT—3100 lbs. domestic or export. Cubage 255.

TUBES—One each 6AG7, 2E26, two each 4-65A, 575A, 872A, 6J7, 6J5, four each 450TH and five 5U4G.

Ordering Data

Complete broadcast transmitter, high fidelity type, for operation from 2 to 22 mc with one set of tubes, less crystals. **Cat. HF1-2Y**

Complete voice and telegraph transmitter, for communications service, for operation from 2 to 22 mc with one set of tubes, less crystals. **Cat. HF1-3Y**

Complete telegraph transmitter only, for operation from 2 to 22 mc with one set of tubes, less crystals. **Cat. HF1-XY**

Crystal in holder, for 0.02% accuracy. **Cat. JI-H17**

Oven to accommodate one or two JI-H17 crystals and holders, to provide 0.005% accuracy. **Cat. JKO-2**

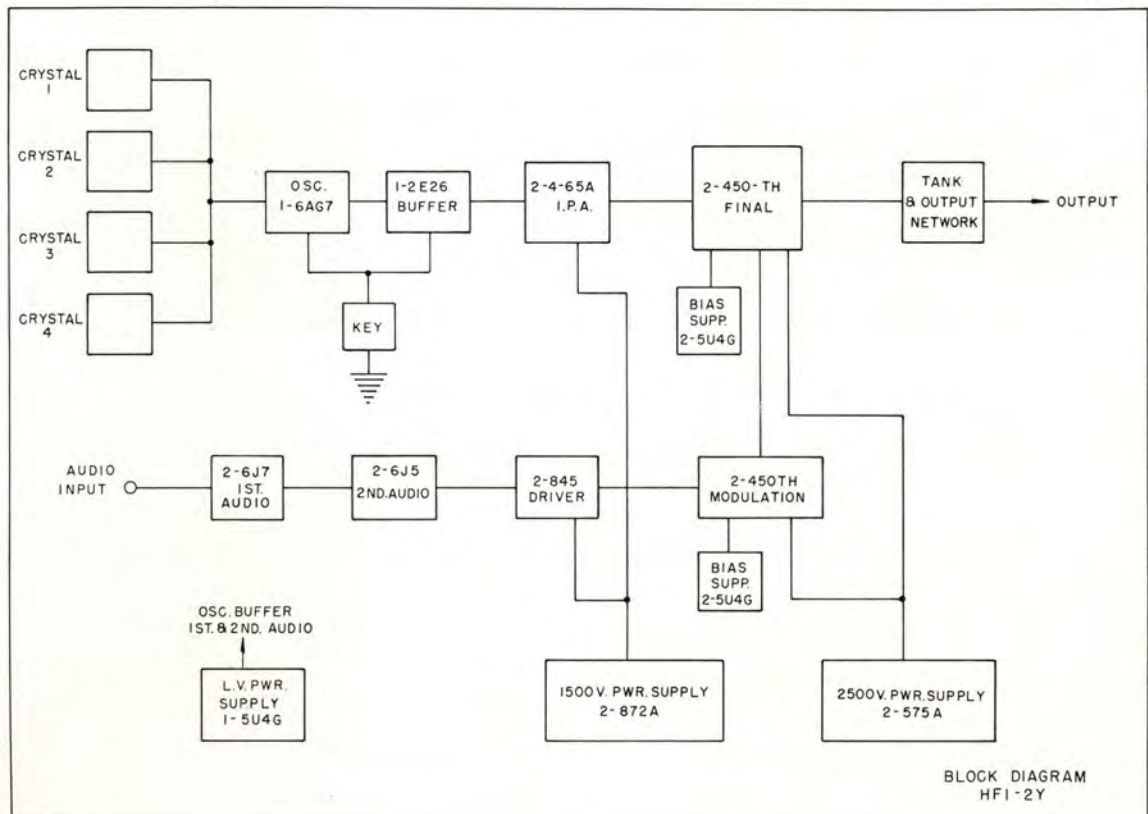

Single or Multi-Channel Communications Transmitters

(250 Watt Carrier)

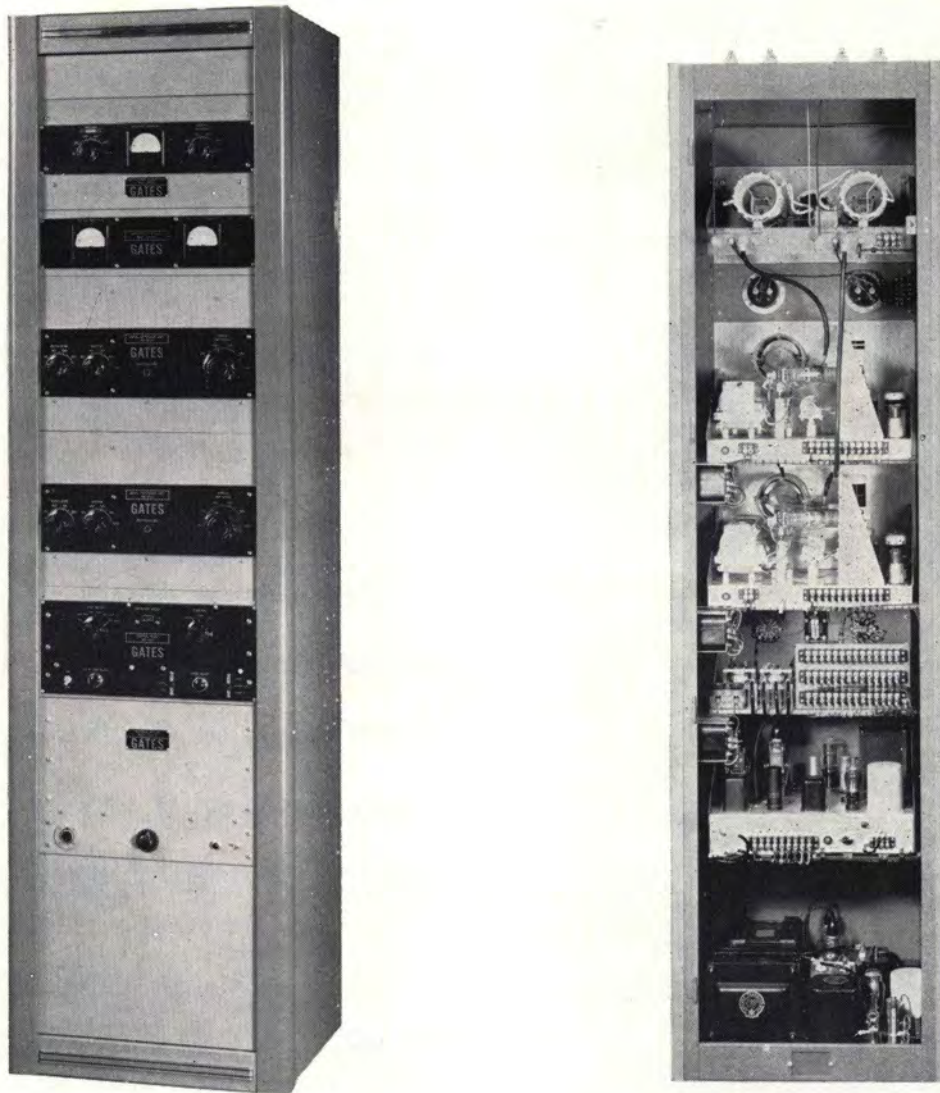

On this and several following pages are listed the popular Gates unit design 250 watt telephone and telegraph transmitters. The design is such that the purchaser may select any transmitter combination he desires, such as a large multi-channel voice and CW transmitter, or the simplest single channel telegraph transmitter. These transmitters are of professional construction and will perform in the finest manner, yet are very modest in price and will fit minimum budgets. The alert engineer will recognize the possibility of standardization. Where several transmitters are employed in a group installation, even though varied in arrangement, the identical design of the individual units assures minimum maintenance standby equipment.

COMMUNICATIONS TRANSMITTERS — 250 WATT

(Unit Construction)

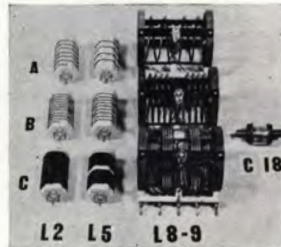

Above, radio frequency unit with plug-in coils. Below, modulator unit for use where above radio frequency unit is to be voice modulated.



RADIO FREQUENCY UNIT

A complete self-contained RF chassis, ready to attach to power supply and output load. Any number may be used for quick change of frequency by means of switching the entire RF chassis instead of retuning or coil changing. — Each RF unit will operate from 2-22 mc by means of 5 sets of plug-in coils with band width of each set listed below. Crystal is temperature controlled (Type H17 with JKO-2 oven, see crystals—index) providing 0.005% accuracy. Keying is in cathode of all stages. A 6V6GT oscillator, 807 intermediate amplifier and P. P. 812A power amplifier stage feeds into a semi-variable output link which will match transmission lines from 50 to 300 ohms. It may be used with antenna tuners listed on Page 81, where coupling is direct to an antenna. Crystal heater transformer is supplied. Size 19" x 12 1/4" panel space and 16" deep overall. Supplied with one set of coils, as ordered from list below. It should be used with M-3460Y meter panel and M-3461Y control panel.

Radio frequency unit with one set of coils, less tubes and crystal. **Cat. M-3452Y**

Complete plug-in set of coils for 2-3 mc operation. **Cat. M-3461**

Complete plug-in set of coils for 3-4.2 mc operation. **Cat. M-3642**

Complete plug-in set of coils for 4-7.2 mc operation. **Cat. M-3643**

Complete plug-in set of coils for 7-13 mc operation. **Cat. M-3644**

Complete plug-in set of coils for 12-22 mc operation. **Cat. M-3645**

Complete set of tubes for radio frequency unit. **Cat. M-3675**

MODULATOR UNIT

This is essentially the complete audio system for use with unit design 250 watt transmitters, and needs only the main power supply listed on Page 82 to complete. A high impedance microphone and 600 ohm line input source are provided. The M-4327 microphone on Page 83 should be used. It includes 3000 cycle cut-off filter and peak limiter to prevent over-modulation. Response between 200 and 3000 cycles is essentially flat and cuts off sharply beyond these extremes, assuring excellent penetrating voice quality. Tubes: 6SJ7 first microphone stage, 6L7 second stage and line input, 6C5 third stage, 6L6 driver, P.P. 811A Class B modulators, 5U4G low voltage power supply rectifier and 6H6 limiter. Push-to-talk relay is self-contained, and obtains its operation voltage from the L. V. power supply self-contained. Panel 19" x 12 1/4" and 14 1/2" deep.

Modulator, less tubes and less microphones. **Cat. M-3453Y**

Complete set of tubes for M-3453Y modulator. **Cat. M-3676Y**

UNIT SYSTEM 250 WATT TRANSMITTERS

UNIT SYSTEM — HOW TO ORDER

Standard units listed on Pages 80, 81 and 82 may be selected for any transmitter combination desired, up to 2 channels. For more channels, special antenna coupler and control panel, built to customer needs, are supplied and quoted on request. Rack cabinets are listed on Pages 63 and 64. RF and modulator units are designed to operate around the meter panel, control panel and power supplies listed herein; but, as all circuits are straightforward, other similar units may be used or constructed by the purchaser. Where factory completion is desired, i. e., mounting in cabinet and interwiring, this will gladly be supplied. A charge of 10% of the total material cost is made for this service.

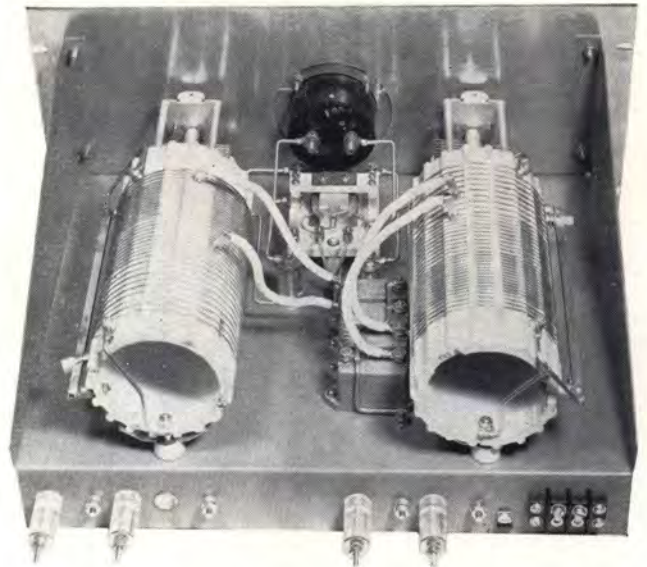

DUAL CHANNEL ANTENNA COUPLER

Couples the output of two radio frequency units into a single or duplicate antennas. It will accommodate antennas having wide range of impedance and as low as 10 ohms. Clip-on coil taps and associate fixed and variable capacitors allow use as an L or T network. Antenna meter 0-3 RF amperes is supplied. Changeover is by means of ceramic insulated heavy contact relays, which switch input and output circuits and the meter. Panel size 19"x8 $\frac{3}{4}$ " and 12" deep.

Dual channel antenna coupler.

Cat. M-3461Y

Shown above is the dual channel antenna coupler. Below, the single channel unit. A wide variety of antenna conditions can be handled.

SINGLE CHANNEL ANTENNA COUPLER

Very similar to the dual channel unit listed above. Where only a single radio frequency unit is used, this single channel coupler is all that is necessary. It has the same electrical circuit and component design as the M-3461Y above; except, for one channel only. Panel size 19"x8 $\frac{3}{4}$ " and 6" deep. It includes 0-3 RF ammeter.

Single channel antenna coupler.

Cat. M-4239

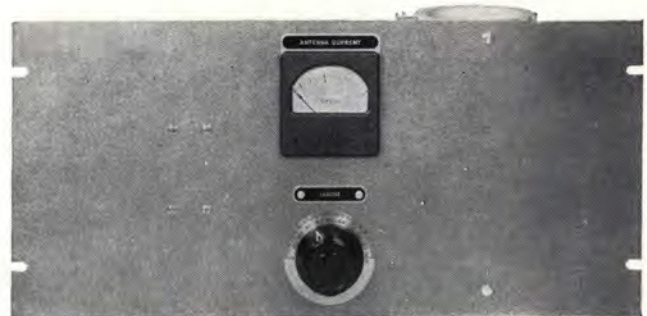

MULTI-CHANNEL ANTENNA COUPLERS

Where more than two channels of radio frequency units are desired, Gates will provide a multi-channel coupler, up to 5 channels, on a standard 19" x 8 $\frac{3}{4}$ " rack panel. If more than 5 channels are required, then multi-channel couplers may be operated in pairs, or any number desired. The multi-channel coupler always operates in conjunction with the multi-channel control panel, which has a like number of channels. The control panel is listed separately on the following page. Gates will gladly quote on the coupler of your choice. Give details as to the number of channels, whether antennas will be separate or one common antenna, and type of antenna or antennas.

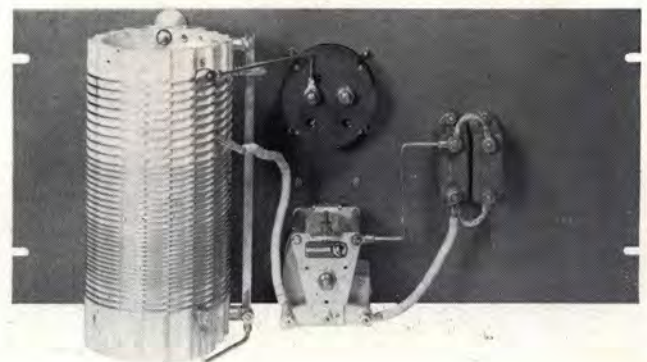

UNIT COMMUNICATIONS TRANSMITTERS

(Continued from preceding page)



MAIN POWER SUPPLY

Usually located in the bottom of the transmitter cabinet, this power supply provides both high and intermediate voltages and bias voltages. It is fully fused. Overload relay is part of the M-3461Y control panel listed below. This power supply will handle two radio frequency decks operating simultaneously, or one RF unit and one modulator. This means that for multi-channel service, no matter how many channels, only one power supply is required. High voltage is provided through two 866/866A rectifier tubes and is 1250 volts DC. Intermediate voltage of 600 volts at 200 ma is provided for intermediate stages in the RF unit. Bias supply, with adjustable output, offers fixed bias to the radio frequency stages for excellent keying, push-to-talk, and low standby current. Input is 115 volts, 50/60 cycles. Tubes: two 866/866A, one each 6X5 and 5R4GY.

Main power supply, less tubes.

Cat. M-3454Y

Set of tubes for M-3454Y power supply.

Cat. M-3677Y

CONTROL PANEL FOR SINGLE AND DUAL CHANNEL OPERATION

The control panel is the focal point of the unit system. From this panel nearly all functions of the complete transmitter are handled, except tuning. Functions include: filament start switch, plate on switch, phone-CW switch, channel selector switch, filament and plate indicator lights, meter range switch, plate on contactor relay, overload relay, keying relay and the channel changing relays. Overload reset is from the front panel. Meter switch allows reading of oscillator plate, 1st IPA grid, 1st IPA plate and PA grid. This unit is used either for single or dual channel operation. Panel size: 19" x 8 $\frac{3}{4}$ " and 10" deep.

Control panel complete.

Cat. M-3461Y

CONTROL PANEL FOR MULTI-CHANNEL

Like the multi-channel antenna couplers, discussed on Page 81, Gates also provides a multi-channel control panel to handle any number of channels desired. Up to five channels may be handled on a 19" x 8 $\frac{3}{4}$ " panel. For more than five channels, a second identical panel is purchased. Give details as to number of channels desired, and we will gladly quote. In every case, the number of channels stated for the control panel should be the same for the antenna coupler.

METER PANEL

Two meters supplied on a 19" x 3 $\frac{1}{2}$ " panel. The left, or test meter, operates in conjunction with the range switch on the control panel, allowing meter readings of oscillator plate, IPA grid, IPA plate and PA grid. The second meter reads directly in the power amplifier plate current circuit. Meters are 3" square case.

Meter panel.

Cat. M-3460Y

FILAMENT TRANSFORMER

For the RF unit or modulator unit a 6.3 volt, 10 ampere transformer is required for the filaments of either the 811A or 812A tubes. This transformer, fully cased, provides this voltage from a 115 volt, 50/60 cycle input source. One is required for each unit, i. e., two would be needed for two RF units, etc.

Filament transformer.

Cat. AF-1994K

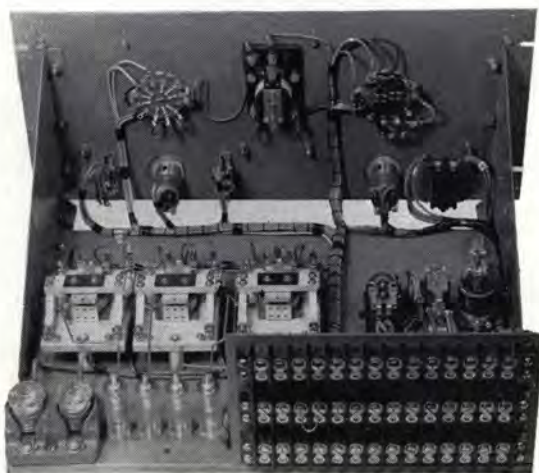

COMPLETE 250 WATT TRANSMITTERS

For those desiring to select completed transmitters in the 250 watt unit system category, several combinations are listed below and may be ordered as such. These will be supplied factory wired and tested. When ordering, please supply operating frequency or frequencies and, where possible, antenna type or contemplated design.

TWO CHANNEL TELEPHONE AND TELEGRAPH

Illustrated in Figure 1 below. Consists of, from top to bottom: dual channel antenna coupler, meter panel, two radio frequency units, control panel, modulator and main power supply. This is all mounted and wired complete in an 84" rack cabinet, ready to use. One set of tubes is supplied—crystals are not supplied and should be ordered separately, to your frequency. This transmitter provides instant band change for any of two operating frequencies between 2-22 mc, and any other set of frequencies by either retuning or coil changing. Both telephone and telegraph operation are possible by the flip of the switch.

Complete two channel telephone and telegraph transmitter.

Cat. M-3449Y



Above, Gates M-4237 and M-4576 microphone with push-to-talk desk stand, cable and plug. The difference in the above referenced type numbers is a difference in plug only. Built for rugged service and provides excellent voice quality.

SINGLE CHANNEL TELEPHONE AND TELEGRAPH

Illustrated in Figure 2 below. Consists of, from top to bottom: single channel antenna coupler, meter panel, one radio frequency unit, control panel, modulator and main power supply. This is all mounted and factory wired in a rack cabinet 68" high, ready to use. One set of tubes is supplied—but crystals must be ordered separately, to your frequency. This transmitter provides single channel operation for both telephone and telegraph at any frequency between 2-22 mc as selected by coil set.

Single channel telephone and telegraph transmitter.

Cat. M-3491Y

SINGLE CHANNEL TELEPHONE AND TELEGRAPH

Illustrated in Figure 3 below. Identical to M-3491Y, listed above, but antenna coupler is not supplied. This allows output to be fed directly to a standard transmission line, or simple antenna where tuning is not required. Supplied with tubes, but less crystal.

Single channel telephone and telegraph transmitter. Cat. M-3680Y

SINGLE CHANNEL TELEGRAPH TRANSMITTER

Illustrated in Figure 4 below. Identical to M-3680Y, listed above, except modulator is not supplied. For a straightforward, good performing, modestly priced 250 watt telegraph transmitter, this model cannot be excelled. Supplied with tubes, but less crystal.

Single channel telegraph transmitter.

Cat. M-3629Y

CRYSTALS

Order type H17 mounted in JKO-2 temperature controlled oven. Full description on other pages of this catalog (see index on Crystals). Note that two H17 crystals with holders will fit into each JKO-2 oven, though only one may be used where needed.

MICROPHONE

Type M-4237, listed and illustrated above. This is a high quality dynamic microphone with push-to-talk desk stand, cable and plug.

Cat. M-4237

HOW TO ORDER

If the model above does not fit your requirements, ordering the model of your choice is simple. Select the rack cabinet desired, on Page 63 or 64. Check the usable rack mounting space in the rack cabinet. Rack panel space for each 250 watt unit is shown on preceding pages. Allow 20" of rack space for the main power supply, even though this fits in the bottom of the cabinet. This will assure proper ventilation. If you desire to wire the various units together in the cabinet, then the foregoing is the total equipment needed, plus any additional coil sets, tube sets or crystals you may desire. If you desire Gates to wire the various units together, and factory test, then multiply the total cost of all items, including cabinet, by 10% to arrive at the total factory wired cost.

CRYSTALS

For 0.02% accuracy, order type H17. For 0.005% accuracy, order H17 mounted in JKO-2 oven. See index for page listing crystals and ovens.



1



2



3



4

Continuously Variable 250 Watt Transmitter

(2-26 mc Voice and CW)



Here is a modernly designed 250 watt telephone and telegraph transmitter that is an innovation in compact commercial equipment. — Complete in every detail. Designed for production line techniques, assuring modest price. Multi-channeling is accomplished by ganging any number of complete transmitters side by side. Other features are:

- ... Continuously variable from front panel, 2-26 mc.*
- ... Four crystal inputs in temperature controlled ovens.*
- ... High gain audio system for microphone or line input.*
- ... 3000 cycle cutoff audio filter.*
- ... Peak limiter self-contained.*
- ... Very modest cost.*

DESCRIPTION 250 WATT TRANSMITTER

(continued from preceding page)

In the CMG-1 communications transmitter, Gates engineers have developed what we believe is a unique 250 watt voice or telegraph transmitting plant. By following a mode of construction allowing production line methods, a transmitter with wide facilities and unusual features has resulted at a price much lower than would be expected. — This allows the use, where multi-channeling is required, of several complete transmitters ganged together. Instant switching of channels is reduced to switching the RF output and AF input, eliminating complicated tuning mechanisms or relays for band change.

Each transmitter, whether used singly or in multiples, is continuously variable between 2 and 26 mc by front panel tuning. There are no plug-in coils or relays to effect frequency change. — The radio frequency section selects from any of four crystal positions into a 6AG7 Colprits oscillator, which has a VR-150 screen regulator tube to assure excellent oscillator stability. A 6146 IPA drives two 812A tubes in the final amplifier. Output is a pi-network, matching a wide variety of impedances from 40 to 300 ohms. On special order, the CMG-1 transmitter can be supplied to match antennas down to 10 ohms.

Modulator is complete, to meet modern requirements for communications, including 3000 cycle cutoff filter and peak limiter to prevent over-modulation. Has ample gain to operate from a low level, high im-

pedance microphone. Provision is also made for 600 ohm line input. Modulators are 811A in Class B.

Two power supplies are standard equipment. Dual 866/866A tubes provide the 1250 volt main plate supply, while a 5V4 intermediate supply rectifier develops plate and bias voltage for intermediate stages. Input is 115 volts, 50/60 cycles.

Metering consists of four meters: PA current, PS volts, RF output and a multi-meter for oscillator plate, IPA grid, IPA plate, PA grid and modulator.—Tuning circuits are oscillator plate, IPA plate, PA plate and antenna loading covering the entire 2-26 mc band. Other front panel equipment consists of: filament start switch, plate start switch, pilot lights, overload reset switches and audio gain control.

Both push-to-talk and keying circuits are relay controlled. Contacts on push-to-talk relay are provided for receiver muting. A vacuum type time delay relay, duplicate overload relays in the PA, and modulator cathode circuits are standard equipment. Cabinet is of heavy cold rolled steel with ample louvers for ventilation in top and the full size back door. Finish is in medium gray. Microphone with push-to-talk desk stand, 7' cable and Cannon plug are recommended. This is identical to M-4237, illustrated Page 83, other than variance in plug type.

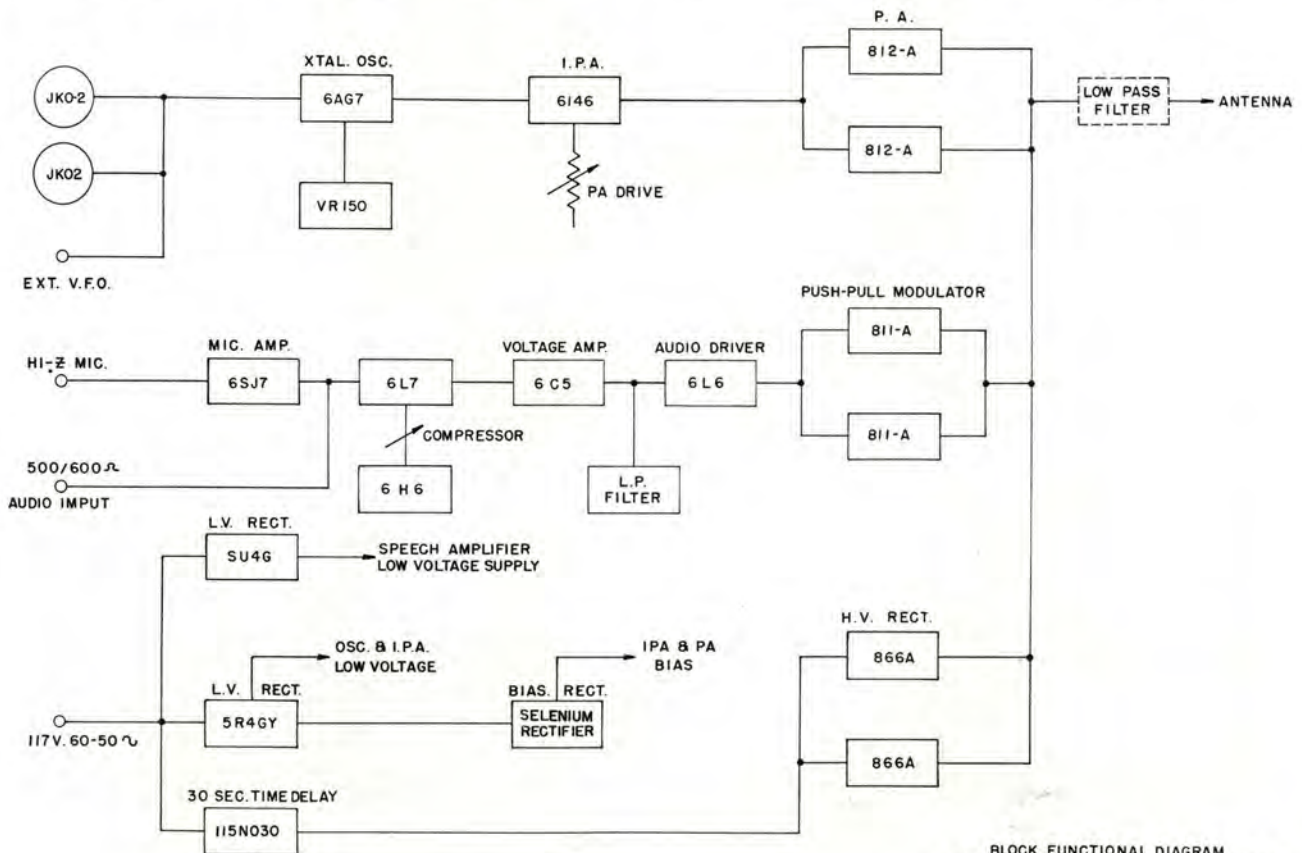

BLOCK FUNCTIONAL DIAGRAM
250 W. COMMUNICATIONS TRANSMITTER
CMG1-M4575

SPECIFICATIONS CMG-1 TRANSMITTER

(continued from Page 85)

Specifications

FREQUENCY RANGE—2-26 mc continuously variable.
POWER OUTPUT—250 watts.
OUTPUT IMPEDANCE—40-300 ohms unbalanced. Lower or higher output impedances available at slightly extra cost.
AUDIO INPUT—Hi-Z for microphone at -55 db input or higher. 600 ohms at 0 dbm input level.
FREQUENCY RESPONSE — ± 2 db 200-3000 cycles with sharp cutoff above 3000 cycles.
DISTORTION—Less than 8% at all frequencies 200-3000 cycles, 95% modulation.
MODULATION—High level Class B.
POWER INPUT—1000 watts at 115 volts, 50/60 cycles, at average modulation.
KEYING SPEED—60 WPM.
NUMBER OF CRYSTALS—Maximum of four (type H17 in JKO-2 oven), two H17 crystals mounting in one JKO-2 oven.
VFO INPUT—Provided on receptacle rear terminal board of transmitter.
TUBES—6AG7 oscillator; 6146 IPA; two 812A PA; two 866/866A rectifiers; 5V4 LV rectifier; 6SJ7 mic. amplifier, 6L7 second amplifier and line input; 6C5 third stage; 6L6 driver; PP 811A modulators; 6H6 limiter tube and 5U4G modulator rectifier.
SIZE—50" high, 23" wide, 26" deep. Door swing 20".
ESTIMATED WEIGHT—550 lbs. packed.
CUBAGE—36.

Filters

Where extreme second harmonic attenuation is desired, Gates offers several filters, listed below, which operate in series with the transmission line to reduce harmonic output to better than 60 db. Mount externally to the transmitter, and are in small shielded containers. Filters vary only as to line impedance.

Ordering Data

Complete 250 watt continuously variable 2-26 mc voice and CW transmitters, less tubes and crystals.

Cat. CMG-1

100% set of tubes for CMG-1 transmitter. Cat. TK-136

Microphone, push-to-talk stand, cable and plug (as illustrated on Page 83).

Cat. M-4576

Filter as described above for 51.5 ohm output.

Cat. LPF-52

Filter for 72 ohm output.

Cat. LPF-72

Filter for 250 ohm output.

Cat. LPF-250

Filter for any other value to specifications.

Cat. LPF-spec.

For crystals and ovens, see catalog page on crystals. (See Page 112.)



Illustration above demonstrates how four or any number of CMG-1 transmitters may be ganged together for multi-channel operation. In this manner, only input and output is switched for instant changeover of frequency. This method eliminates complicated band change relays or tuning mechanisms, and also provides complete independent operation. Failure of one transmitter leaves all other frequencies in operation, as each frequency is a complete transmitter.

500 Watt Phone and Telegraph Transmitter

(2-22 mc 500 Watts Carrier)

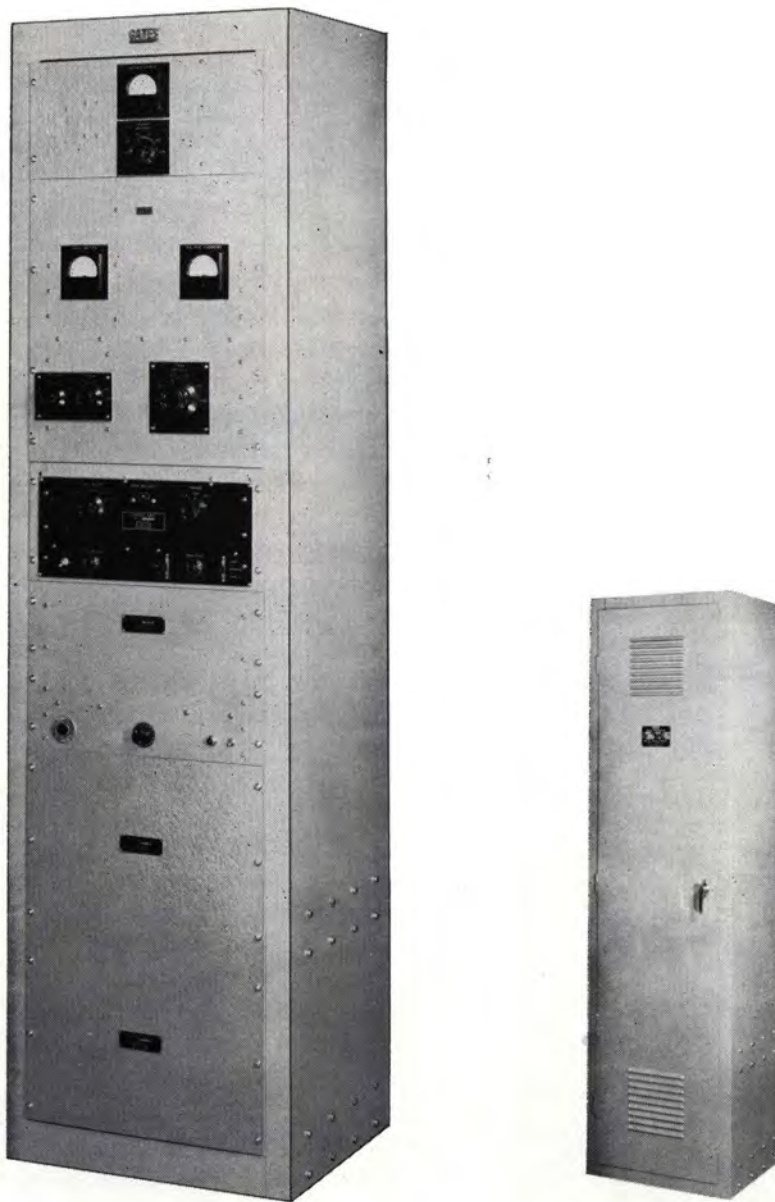

Here is a new Gates product, designed to fit the many communications needs for a 500 watt voice and CW transmitter. It is modest in price, yet has built-in quality found only in the very finest commercial transmitting equipment.

Ready to attach to antenna and receiver, the Gates CMW-1 transmitter includes peak limiting of modulation, push-to-talk voice control, 3000 cycle cutoff filter, regulated low voltage power supplies, an abundance of safety factors, both in RF output and modulator power, plus quality in materials and workmanship. — This, plus straightforward, easy to service design, assures a reliable transmitting plant that may be used for the most exacting communications service.

CMW-1 500 WATT COMMUNICATIONS TRANSMITTER

(telephone and telegraph)

Basic equipment in the Gates CMW-1 transmitter includes antenna matching and coupling equipment, the complete radio frequency unit, control panel, speech amplifier and modulator unit, low voltage and bias power supplies, high voltage power supply and the cabinet housing. Transmitter is completely wired, factory tested, and ready to use when unpacked. The few heavier components, which have been removed for shipping purposes, are inserted. — This transmitter is attractively finished in medium gray with etched black escutcheons. A full size back door, along with unit design, assures quick access to the most minute part in the transmitter.

ANTENNA COUPLER — Consists of a space wound coil on ceramic form, with associate variable and fixed capacitors. From this, it is possible to arrange a “T”, “L” or “Pi” network. Matching output impedances from 30 to 600 ohms are possible. A 3” square case antenna or line ammeter is standard equipment. Scale 0-5 amperes.

RADIO FREQUENCY SECTION—This unit is completely self-contained, and comprises the entire radio frequency portion of the transmitter—except power supplies, which are described elsewhere on these pages. The JKO-2 temperature controlled crystal holder assures 0.005% accuracy and accommodates type H17 crystals and holders. These are selectable from the front panel for quick frequency change within the band width of each set of coils, or for a second frequency operating with another set of plug-in coils. A Colprits oscillator provides excellent keying and push-to-talk operation. The screen of the 6AG7 oscillator tube is regulated at 150 volts. — The intermediate power amplifier is a 4-65A tube, supplying an abundance of drive and no neutralization requirement. The final power amplifier is a pair of 100-TH tubes in push-pull. This develops long tube life through conservative tube rating. Coils for band change are plug-in. One set is supplied with each transmitter. Complete coil sets are listed on Page 90, with band widths stated. Two meters are part of the radio frequency unit. One is a multi-meter—which reads through a selector switch on the control panel—for oscillator plate, IPA grid, IPA plate and PA grid currents. The other meter reads PA plate current. Frequency range is 2-22 mc and full power output is possible at all frequencies.

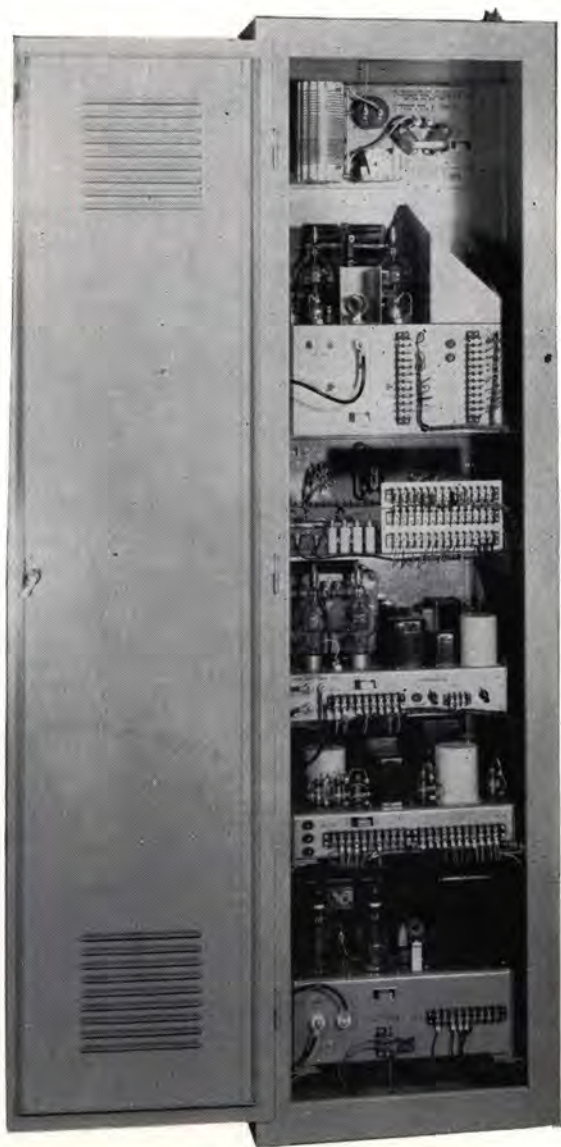

CONTROL PANEL — This panel handles the necessary functions of control for the entire transmitter. It includes: filament on switch with pilot light, plate on with pilot light, CW-Phone switch (relay controlled), meter selector switch (for RF unit), tune-up switch (for tuning low power stages with power amplifier off), overload relay, time delay relay, plate contactor relay and keying relay. This panel is located in the center of the cabinet.

SINGLE CHANNEL 2-22 MC 500 WATTS

(continued from preceding page)

MODULATOR—The speech amplifier-modulator, like the radio frequency unit, is self-contained. Two inputs, high impedance low level microphone, and 600 ohm line are selectable by a switch on the back of the chassis. Push-to-talk relay, which operates from the microphone assembly, is part of the equipment and obtains its voltage from the self-contained power supply that also provides voltage for all AF stages except the modulator. Peak limiting amplifier, part of the equipment, is adjustable to 100% or less modulation. A 3000 cycle cutoff filter sharply attenuates all frequencies above 3000 cycles. Response below 200 cycles is also sharply attenuated. This assures penetrating voice quality at high modulation and with minimum side band modulation. There are 5 audio stages in all (4 for line input). The Class B 100-TH modulators develop more modulator power than is required; thus, long tube life.

LOW VOLTAGE POWER SUPPLIES — Located below the modulator is a deck of two low voltage power supplies. This deck supplies all filament voltages, oscillator plate and screen voltage, buffer bias and plate voltage, power amplifier bias voltage and bias voltage to the Class B modulators. Oscillator screen voltage is regulated by a 0D3/VR150 tube and modulator bias is regulated by a 0R3/VR75 regulator tube. There are two separate DC supplies for

the above functions, utilizing 5R4GY and 5U4G tubes.

HIGH VOLTAGE POWER SUPPLY — To develop the approximately 2300 volts applied to the power amplifier and modulator tubes, a full wave, well filtered supply is incorporated into the CMW-1 transmitter. Rectifiers are two 8008 tubes. Filter includes both swinging and smoothing choke coils, along with 4 mfd and 2 mfd capacitors. Balance of power supply includes appropriate fusing, rectifier filament transformers and terminations. Protective relays and interlock control are part of the control panel listed on Page 88.

CABINET — A heavy steel cabinet of 16 gg. cold rolled furniture steel, resistance welded and prime coated, over which is hot sprayed a medium gray finish, is supplied to house the complete assembly of units outlined above. A full size back door with interlock switch swings 20", and this clearance should be provided to the back wall. Size: 84" high, 23" wide and 18" deep, exclusive of back door swing. Antenna or line terminations are by feed through insulators, located at the top of the cabinet. Balance of terminations are through the base of the cabinet.

MICROPHONE — The complete push-to-talk microphone, desk stand and cable with plug are illustrated on Page 83, type M-4576. Ordering data is on Page 86.

Left, below, is complete radio frequency chassis of CMW-1 transmitter.
Right, below, is the speech amplifier-modulator unit with self-contained limiter and 3000 cycle cutoff filter.

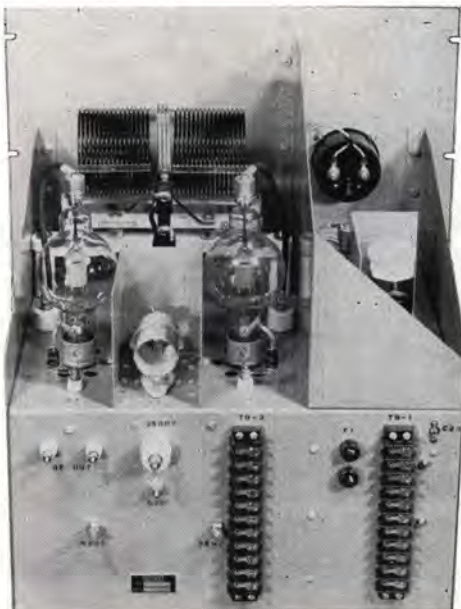

CMW-1 SPECIFICATIONS AND ORDERING DATA

(500 watts Phone and CW)

FREQUENCY RANGE—2-22 mc by plug-in coil sets as listed below (one set provided with transmitter as ordered).

FREQUENCY STABILITY—0.005%.

POWER OUTPUT—500 watts telephone or telegraph.

OUTPUT IMPEDANCE—30-600 ohms unbalanced.

May be provided for antennas less than 30 ohms, where specified, at slight additional cost.

AUDIO INPUT IMPEDANCES—Hi-Z for dynamic microphone similar to, or as listed below. 600 ohms for line input.

FREQUENCY RESPONSE— ± 2 db 200 to 3000 cycles with sharp attenuation above and below these frequencies.

DISTORTION—Less than 8% 200-3000 cycles, at 95% modulation.

MODULATION—High level Class B.

POWER INPUT—At 108/115 volts, 50/60 cycles; standby (key up), 5 amperes. At full power 100% modulated, 15 amperes.

KEYING SPEED—60 WPM.

NUMBER OF CRYSTALS—Two type H17 in one JKO-2 temperature controlled holder. Should be ordered separately to frequency—not supplied as standard equipment.

TUBES—6AG7 oscillator, 4-65A IPA, two 100-TH RF amplifiers, two 100-TH modulators, 6SJ7 microphone amplifier, 6L7 limiter and audio, 6C5 audio, 6SN7 inverter, two 6L6 driver amplifiers, 6H6 compressor rectifier, two 5U4G rectifiers, 5R4GY rectifier, 0D3/VR150, 0D3/VR75 regulators and two 8008 mercury rectifiers.

SIZE—84" high, 23" wide, 18" deep. Door swing 20".

WEIGHT—900 lbs. packed.

CUBAGE—32.

FILTERS—If additional harmonic filtering of the RF output is desired, see filters listed on Page 86, which are applicable to this model also.

Ordering Data

Complete 500 watt Phone and CW transmitter with one set of coils for band width as specified when ordering (see below), less tubes, crystals and microphone. **Cat. CMW-1**

100% set of tubes for CMW-1 transmitter. **Cat. TK-137**

Dynamic microphone with push-to-talk desk stand, cable and plug. **Cat. M-4576**

Complete coil set for CMW-1 transmitter for 2-2.5 mc. **Cat. FDK-2A**

Complete coil set for 2.5-3.5 mc. **Cat. FDK-2B**

Complete coil set for 3.5-4.2 mc. **Cat. FDK-2C**

Complete coil set for 4.2-7.0 mc. **Cat. FDK-2D**

Complete coil set for 7.0-11.0 mc. **Cat. FDK-2E**

Complete coil set for 11.0-18.0 mc. **Cat. FDK-2F**

Complete coil set for 18.0-26.0 mc. **Cat. FDK-2G**

NOTE—Coil sets FDK-2A through FDK-2C include padding capacitors as part of kit.

CRYSTALS—Order H-17 in JKO-2 holder—see Page 112 for crystals. When ordering crystals, note that all operation above 13 mc is doubled from crystal frequency. Example: for 18 mc operation, crystal would be ordered at 9 mc.

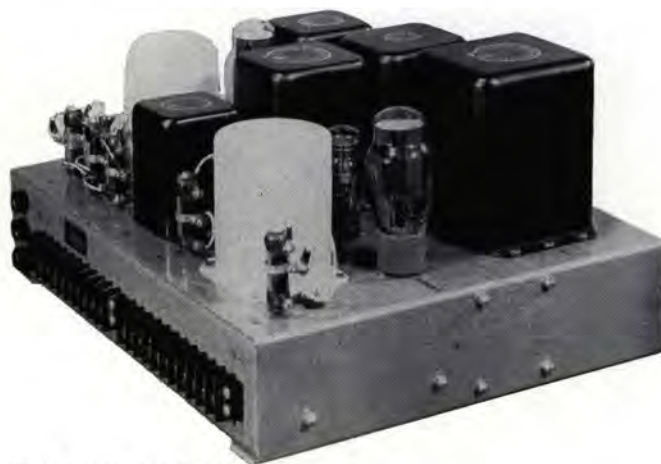

Above, left, the low voltage power supply deck.
Right, the main high voltage supply delivering 2300 volts to power amplifiers and modulators.

1000 Watt Telegraph Transmitter

(for high speed police communications)

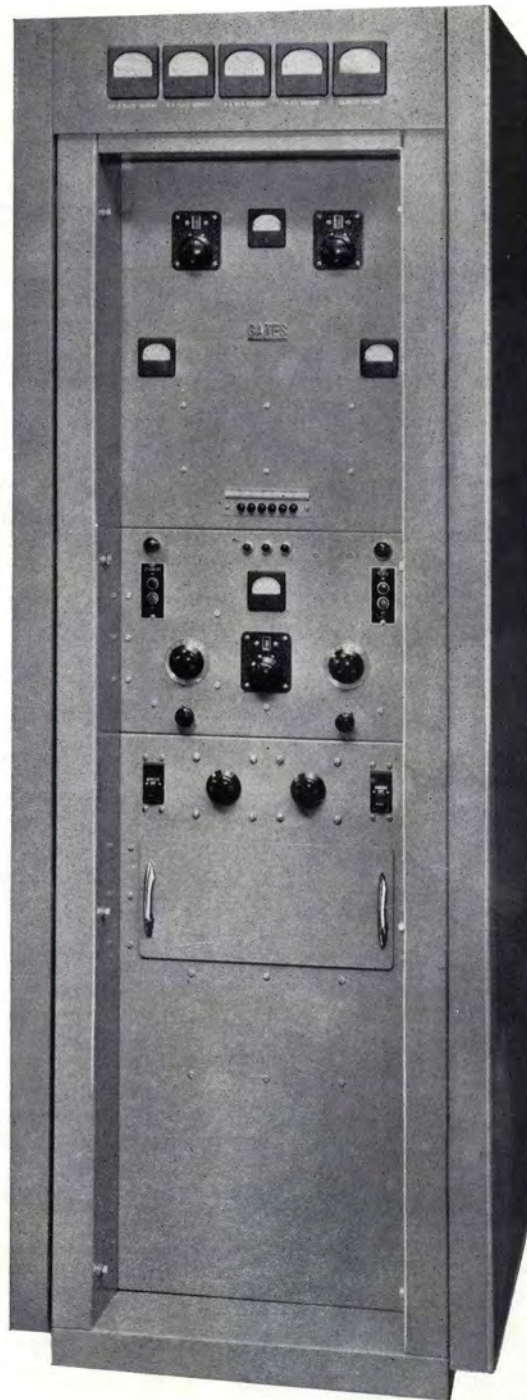

A new Gates commercial transmitting plant—designed specifically for police service between 2808 and 7935 kc, but with many other universal applications—models adaptable up to 22 mc. Features electronic keying and multi-plug-in oscillators for quick frequency change plus remote control operation.

GATES CMP-1 TELEGRAPH TRANSMITTER

(1000 watts carrier)

Though particularly designed for the heavy demands of continuous operation in intrastate and interstate police communications, the Gates CMP-1 transmitter has many uses. In fact, wherever a truly fine 1000 watt output telegraph transmitter is desired, this transmitter will merit consideration.

In police service, operating frequencies are grouped closely together; such as, 2804 kc, 2808 kc and 2812 kc. Others are 5135, 5140 and 5195 kc and 7480, 7805 and 7935 kc. These may vary for different areas. This close grouping allows, in most instances, the switching of the oscillator-crystal circuit only. It will, thus, be noted that a feature of the design is provision for three plug-in oscillator assemblies which may be operated either from the front of the transmitter or from a remote control panel situated on the operator's desk. — For applications other than police service, any frequency or group of three closely associated frequencies may be used between 2 and 22 mc as ordered. Where two groups of widely different frequencies are employed, such as 2804 to 2812 mc and 5135 to 5195 kc, then two transmitters would be used. The same would be true for three groups of widely varied frequencies — three transmitters would be employed.

Nothing has been spared to make the Gates CMP-1 equipment the finest money can buy, realizing that dependability is of paramount importance. Though most police service is limited to 1000 watts input, this transmitter will operate up to 1200 watts output, continuous telegraph duty. This adds to reliability. The following detail will assist in determining the CMP-1 transmitter quality and completeness in design:

OSCILLATOR UNITS — The oscillator units are illustrated in the two photographs below. Each

transmitter will accommodate three oscillators, which are of the plug-in type and slide into the front of the transmitter, as illustrated. The oscillator is completely self-contained, other than power supply, and is provided with temperature controlled crystal holder for 0.005% accuracy. Switching of oscillators is by means of three relays which operate from push-buttons on the transmitter front, as well as from a remote panel. The latter may be ordered if desired.

RADIO FREQUENCY — The output of the oscillators mentioned above feed into a 6AG7 doubler stage, self-neutralized. The doubler and oscillator are electronically keyed (see keyer below). The second intermediate power amplifier is a 4-65A, self-neutralized; and the power amplifier is two 4-400A tubes, self-neutralized and in parallel. Output coupling provides unusually good harmonic attenuation. This is a parallel resonant tank circuit into an L section, which develops a pi-network. Because of this type of circuit, the purchaser should stipulate the output impedance when ordering. Most common impedances are 51.5 and 72 ohms, but other impedances from 30 to 300 ohms may be provided as ordered. Maximum carrier output is 1200 watts, which may be reduced as desired for lower carrier power.

KEYING — The electronic keyer is a type 811A tube which keys in the plate circuit of the oscillator and first IPA-doubler stage. Principle of keying is biasing the 811A tube so with the key closed no current is drawn by the tube. Keying is clean. Though keying up to 100 WPM is recommended, higher speeds are not unusual. The CMP-1 transmitter may also be adapted to frequency shift keying, and will be so supplied when stated on the order. Frequency shift keyers are listed elsewhere in this catalog (see index).

Below, left, illustrates three plug-in oscillator units in transmitter, ready to use.
Right, individual oscillator removed for servicing, or exchange for another operating frequency.



MODERN DESIGN FOR 24 HOUR SERVICE

(Gates CMP-1 1000 watt CW)

VOLTAGE CONTROL — Filament and plate rheostats, adjustable from the front panel, provide all normal voltage control for varying line conditions.

METERING — Nine meters are standard equipment, reading: filament voltage, plate voltage, final screen voltage, final screen current, final plate current, final grid current, second IPA plate current, second IPA grid current, and a multi-meter for oscillator plate and first IPA plate current.

POWER SUPPLIES—Four are supplied. Main high voltage supply, full wave with 8008 mercury rectifiers, delivers approximately 2500 volts to the PA amplifiers. Two additional low voltage supplies provide bias to the power amplifier and plate and screen voltages to low power stages. A selenium low voltage supply gives DC to the oscillator switching relays for remote operation.

PROTECTION — Relays are incorporated for final plate overload, bias under voltage, and air pressure control, plus time delay. Transmitter has primary circuit breakers and fusing. Rear door interlock operates with plate contactor. The transmitter is of "dead front" design. — The air pressure control is of the diaphragm type, operating on the amount of air being sent to the power amplifier tubes. Thus, any air failure such as from a clogged air filter, punctured canvas blower boot, or blower failure will immediately disconnect the plate voltage to the tubes.

REMOTE CONTROL—Illustrated at the bottom of Page 92 is the remote control panel. This is a standard 19" x 5 $\frac{1}{4}$ " rack panel which includes the necessary facilities for operating the CMP-1 transmitter remotely from a control desk. This panel includes: plate on-off switch, keying facility, pilot lights indicating filament and plate "On" and push-buttons for selection of operating frequencies. Remote control up to 1000 feet is possible.



Remote unit provides complete control of the CMP-1 transmitter from operator's desk. The remote panel is an accessory item.

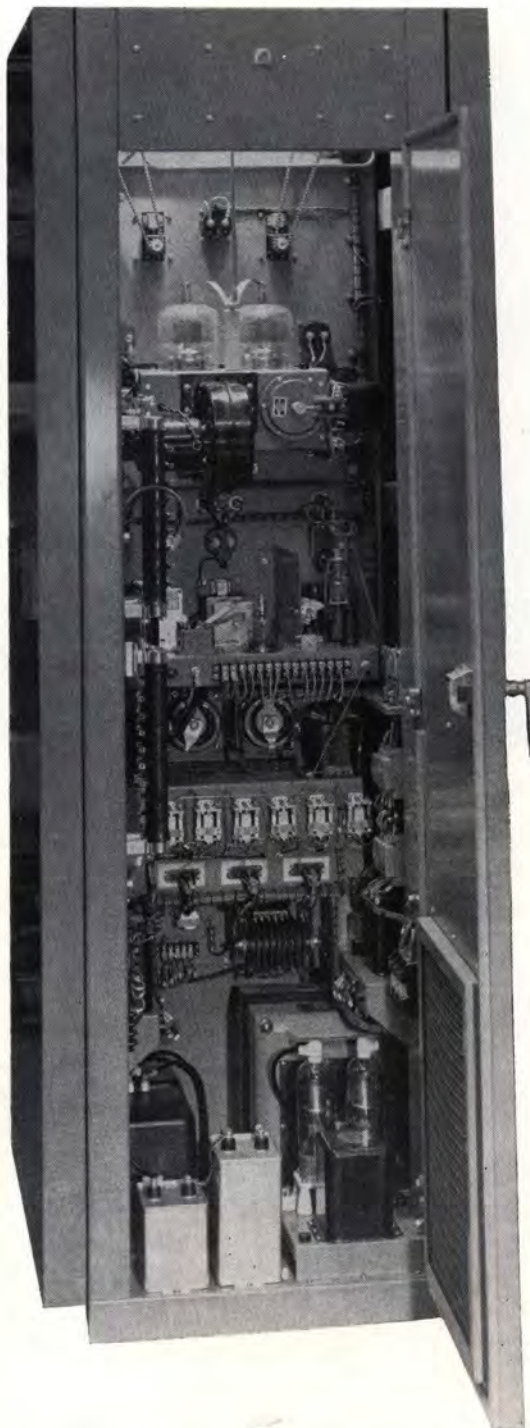

A glance inside the CMP-1 transmitter instills confidence of dependability. You will note the husky components, neat workmanship and symmetrical arrangement of components for proper electrical design.

SPECIFICATIONS AND ORDERING DATA MODEL CMP-1 TRANSMITTER

(1000 watt telegraph transmitter)

FREQUENCY RANGE—Designed specifically for 2-8 mc police frequencies, but may be provided for other frequencies up to 22 mc, as ordered.

OSCILLATORS—Three supplied to frequency as ordered.

MAXIMUM POWER OUTPUT—1200 watts CW.

POWER INPUT—Approximately 1900 watts at 1000 watts output.

INPUT VOLTAGE—230 volts, 3 wire, single phase, 50/60 cycles.

KEYING—Electronic, recommended 100 WPM or less.

FREQUENCY SHIFT KEYING—Adaption for FSK available where ordered, otherwise not supplied.

SIZE—78" high, 28½" wide, 32" deep.

WEIGHT—Approximately 1100 lbs. packed.

CUBAGE—63.

TUBES—Three 6AG7 oscillators (one for each unit), 6AG7 1st IPA doubler, 4-65A 2nd IPA, two 4-400A power amplifiers, 811A keyer, two 8008 rectifiers, 5Y3GT bias rectifier, 5U4G low voltage rectifier.

LOGGING—Veeder counter control on all variable coils to 1/10 turn. Dial control on variable condensers.

Ordering Data

- Complete transmitter** for operation on 2804, 2808 and 2812 kc, less tubes and crystals. **Cat. CMP-1**
- Complete transmitter** for operation on 5135, 5140 and 5195 kc, less tubes and crystals. **Cat. CMP-1A**
- Complete transmitter** for operation on 7480, 7805 and 7935 kc, less tubes and crystals. **Cat. CMP-1B**
- Complete transmitter** for operation on any group of closely associated frequencies not stated above, up to 22 mc, less tubes and crystals. **Cat. CMP-1D**
- Remote control panel.** **Cat. CON-2**
- 100% set of tubes** for CMP-1 transmitter. **Cat. TK-138**

NOTE—For crystals, order type H17 in JKO-2 temperature controlled holder (see index under Crystals). Tube set TK-138 applicable for any of above transmitters. — Type CMP-1D transmitter, state frequency or frequencies when ordering. — The above transmitters are manufactured for operation at specific frequencies, and are not multi-band transmitters. For multi-band transmitters, see type HF1, Page 76.

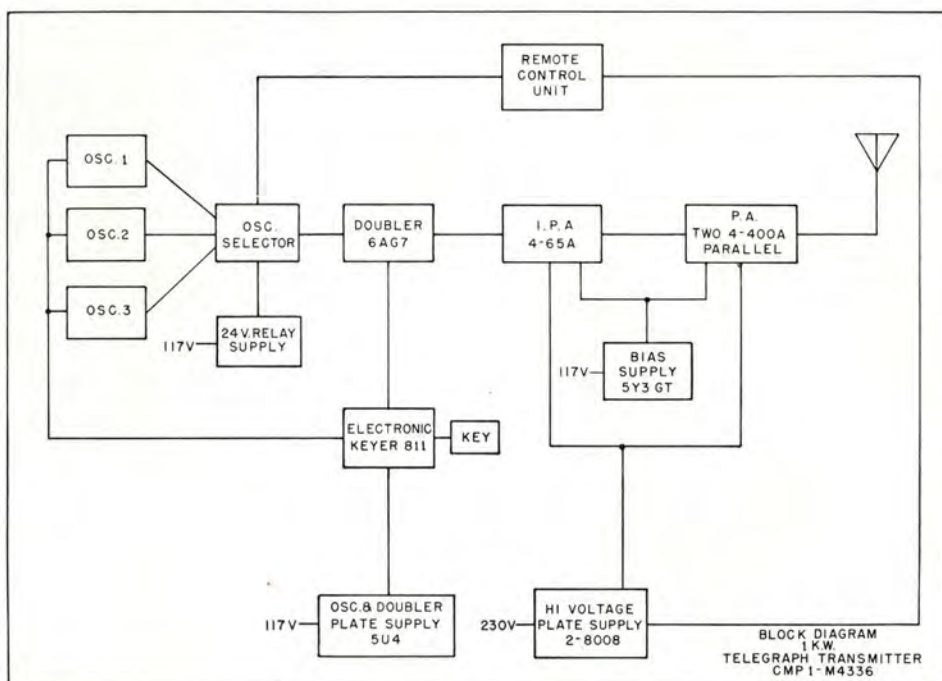



Above, main control room of Radio Station WPHE, Indiana State Police, Indianapolis, Indiana. Control and audio equipment illustrated, manufactured for the Indiana Police System by Gates. The state-wide FM police system of Indiana is equipped with Gates 3 kw FM amplifier units, also.

Gates engineers invite correspondence and conference with Police radio engineers in the planning of state-wide or individual radio systems. — The pages of this catalog will demonstrate the versatility of the Gates engineering department in coping with, not only transmitter problems, but also with audio, antenna, transmission line and all matters related to the complete communications operation. No subject is too small or too large.

There is a Gates sales office or field sales engineer near you, who will gladly confer with you without obligation. A wire, letter, or phone call will bring him to your office.

GATES RADIO COMPANY
Quincy, Illinois.

20 KW Short Wave Transmitter

(4-22 mc Broadcast, Voice and CW)

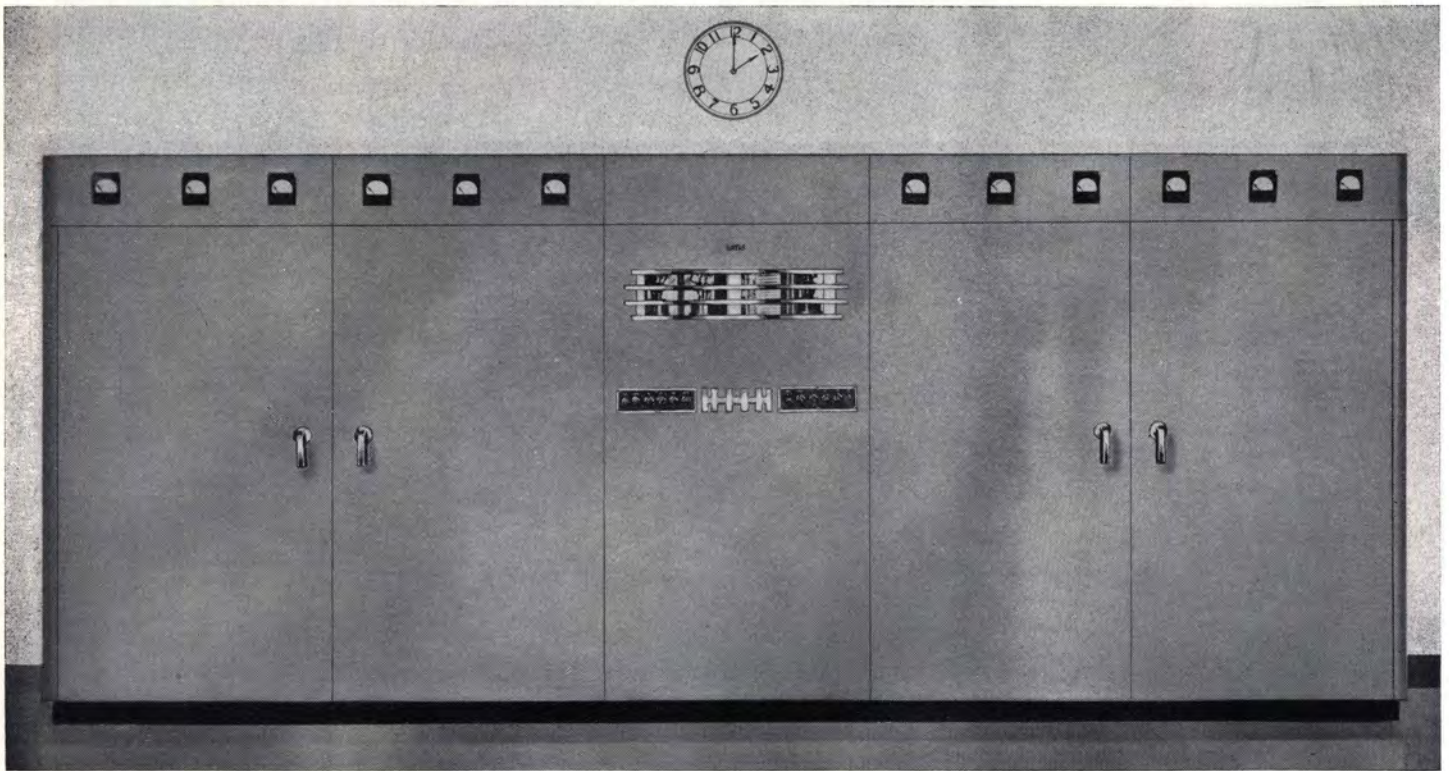

Engineers responsible for international operations, whether communications or short wave broadcast, will be especially interested in the care and attention given to the design of the Gates HF-20, twenty thousand watt transmitter. — Emphasis is on trouble-free operation, top performance in all climates, and complete absence of trick circuits and complicated mechanical tuning mechanisms.

Ease of installation—straightforward circuit design—100% air cooled—continuously variable except final tank—new low cost tubes—duplicate high voltage power supplies—and three models to choose from—are a portion of the HF-20 story. More details are on the following pages.

— FOR ALL MODES OF HIGH FREQUENCY TRANSMISSION

(20 kw, 4-22 mc)

In Gates HF-20 series twenty thousand watt transmitters three types are offered for short wave, and a fourth type for standard broadcast frequencies. These are:

Model HF-20B, a complete 20 kw short wave broadcast transmitter.

Model HF-20BX, the same as the HF-20B but with high speed telegraph, and provision for frequency shift keying adaption.

Model HF-20TX, a 20 kw telegraph transmitter only.

Model BC-20B, a 20 kw broadcast transmitter for 540-1600 kc operation.

All models are very similar other than coil arrangement, and the elimination of the audio section in the case of the HF-20TX telegraph model. The simplified schematic diagram on Page 99, along with the several following paragraphs, will supply proper description.

CONSTRUCTION — Five cubicles join together to house the 20 kw radio frequency, audio frequency, protective and power supply units. The only external components are the two main

power transformers, modulation transformer and reactor. These units are oil filled and may be installed either in the building or on a protected platform outside the building. The transmitter is dead front, and all front doors may be opened without disrupting the carrier. No inter-cubicle cabling is required when installing. Each of the five cubicles is completely assembled and wired. These cubicles bolt together speedily. At the base of each cubicle are barrier terminal boards; and wiring of all cubicles together for an operating transmitter is accomplished by means of short jumpers between these terminal boards. Floor space, exclusive of external units mentioned above, is 210" wide, 78" high and 49" deep. Door swing of 40" should be allowed for both front and back doors. Finish is in hand rubbed medium gray with trimmings in chrome, brushed aluminum and anodized black.

OSCILLATOR — A quickly detachable unit of the transmitter. A Colprits oscillator and a low powered first IPA stage tune the entire 4-22 mc band from the front panel. Four crystal positions, all temperature controlled, assure 0.005% frequency stability. Provision is also made for attaching a frequency shift keyer and an external variable frequency oscillator, where desired.

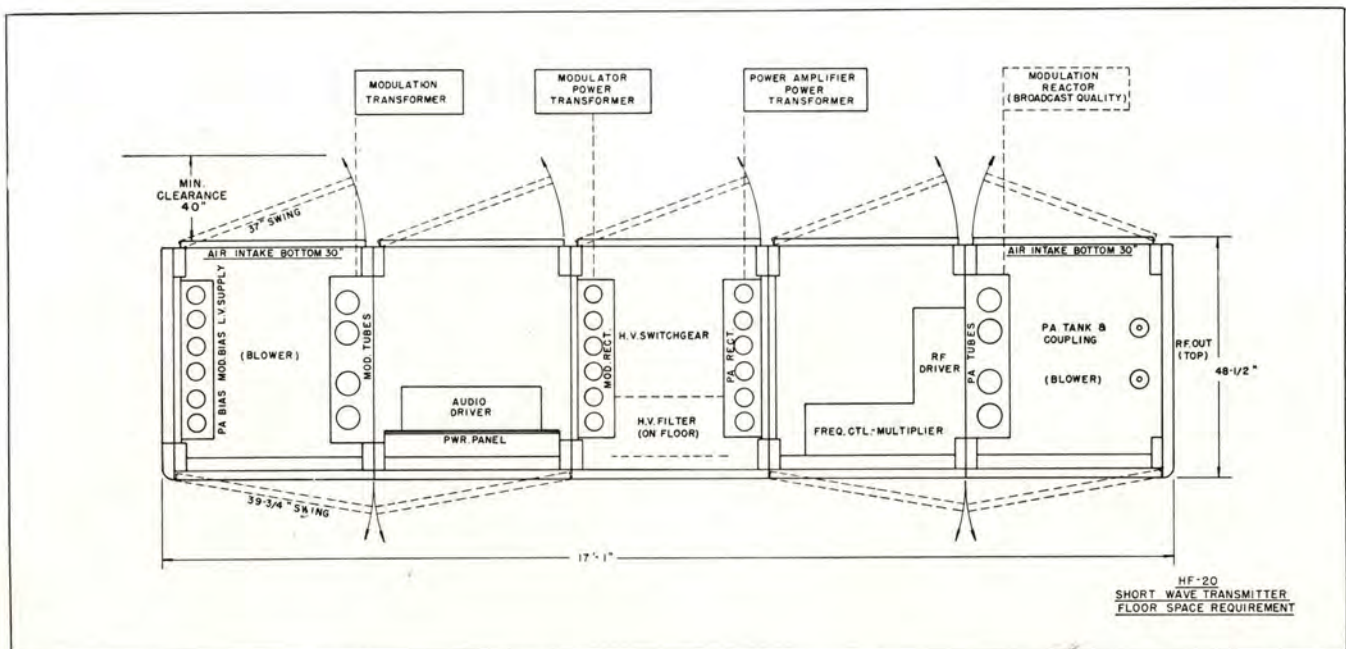

Floor plan of Gates 20 kw short wave broadcast transmitter. Space requirements are considered minimum for a transmitter of this power requirement. External components may be mounted outside of building, where desired.

GATES 20 KW HIGH FREQUENCY TRANSMITTERS

RADIO FREQUENCY — Including the oscillator, there are five stages. The second IPA-doubler is a 6146 tube self-neutralized, the RF driver a pair of 4-250A tubes self-neutralized, and the final power amplifier contains four 3X2500F3 tubes in push-pull parallel. On short wave models, output is balanced into a 300-800 ohm line. On broadcast models, output is from 50 to 270 ohms, as ordered. The entire operation is continuously variable from the front panel on the short wave models, except the power amplifier tank circuit. For this service, Gates has developed the latch-on tank coil system and tank coils may be changed in a matter of seconds, eliminating all complicated tuning and band change mechanisms in the high power stage. Veeder counter type dials are used on all variable coils for split turn logging for frequency change. Of particular importance is the use of the thoriated tungsten filament 3X2500F3 tubes in the power amplifier, assuring long tube life and very low noise.

AUDIO FREQUENCY — Has four stages with push-pull parallel Class B 3X3000A3 tubes as modulators. Feedback is employed as an adjunct for improved noise reduction and less distortion. However, the HF-20 series transmitters will meet all acceptable standards without feedback. This means that feedback is not employed as a substitute for component size but, instead, to further improve the excellent performance possible without feedback.

METERING — No multi-metering is employed, and a full meter complement is supplied to measure all necessary circuits both for tune-up and general operation. Individual plate current meters are provided for each of the power amplifier and modulator tubes.

PROTECTION — Again Gates engineers have provided protection to the point that no power consuming circuit of importance has been overlooked. Primary thermal breakers are inserted in all main primary lines. Individual super-

visory overload relays are incorporated for, not only the transmitter main overload, but also for separate protection; exciter failure, air failure, RF driver, power amplifier, audio driver and modulators. Included are secondary relays for door interlock and air cooling interlock. Automatic condenser discharge relay switch immediately discharges the main filter capacitors when the door interlocks are disengaged.

RECYCLING — Automatic recycling relay controls automatically where the carrier is disrupted, and attempts to reset the carrier four times before remaining off. As many times carrier interruption is caused by static discharges across the transmission line or tower base, this recycling feature is indispensable.

POWER SUPPLIES — Five major power supplies deliver plate and bias voltage to the HF-20 transmitter. Featured are the two complete high voltage supplies. One is used for the radio frequency power amplifier and the other for the modulators. The resulting almost perfect regulation is quickly recognized by the engineer. Likewise, in case of failure of one power supply, the remaining one can be bussed in, operating the transmitter on reduced power until repairs are made. Each of these power supplies are full wave, three phase, six tube supplies. Other individual supplies provide modulator bias voltage, power amplifier bias voltage and intermediate voltage for driver stages. All power supplies are generously protected by circuit breakers, overload relays, etc. (see PROTECTION above).

KEYER — In the HF-20BX and HF-20TX models, electronic keying is through an 812A tube so biased that with key closed no current is drawn. This operates in conjunction with the oscillator and IPA doubler stage. Keying speeds up to 400 WPM are possible, with excellent square top wave form.

Specifications on Page 100

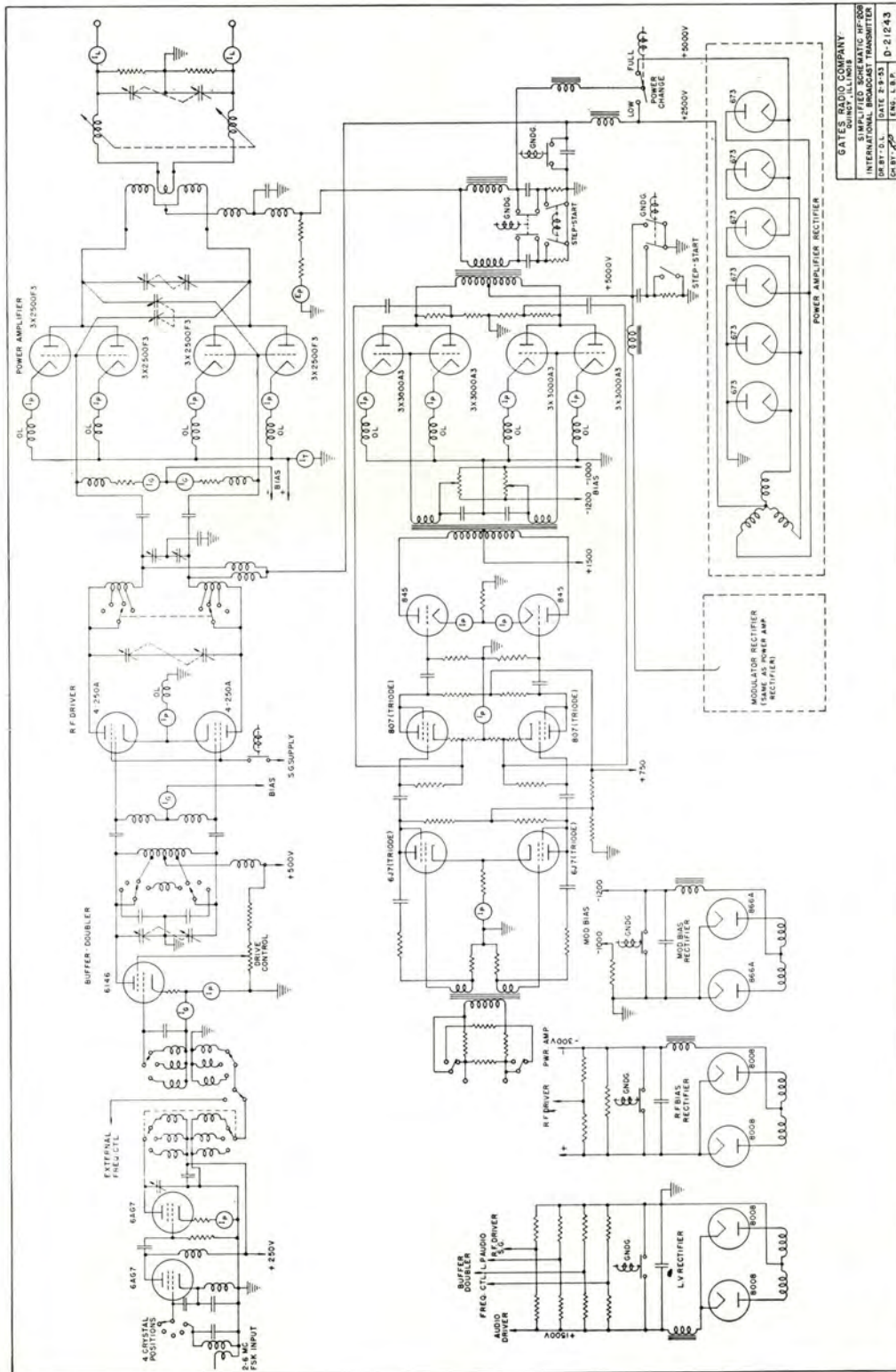

This is the simplified schematic diagram of the HF-20B high frequency transmitter. The extensive control and protective circuits are omitted to provide clarity. The engineer will note straightforward circuit design. Audio feedback is an adjunct to better performance and not mandatory for excellent operation. For telegraph models the audio frequency portion is eliminated.

MODEL HF-20 AND BC-20 TRANSMITTERS

(20,000 watts)

SPECIFICATIONS

- FREQUENCY RANGE**—4-22 mc standard HF-20 models. May be provided to 2 mc on special order. Model BC-20B range, 550-1600 kc.
- POWER OUTPUT**—20 kw at 100% modulation 2-18 mc and 550-1600 kc. From 18-22 mc, 16 kw. Telegraph models may be operated at slight excess to above ratings, depending on mode of keying.
- POWER INPUT**—Key down, no modulation, approximately 37 kw. Average program modulation, approximately 43 kw. At 100% modulation, approximately 55 kw.
- INPUT VOLTAGE**—230 volt, 3 phase, 50 cycles (60 cycles available where stated). Other primary voltages on special order.
- INPUT IMPEDANCE**—600 ohms at +14 dbm.
- OUTPUT IMPEDANCE**—300-800 ohms into balanced line for high frequency models. 51.5, 72 or 250 ohms, as ordered, for BC-20B.
- CRYSTALS**—Provision for four in two ovens, selectable from front panel. 0.005% accuracy.
- TUBES**—6AG7 oscillator, 6AG7 first IPA, 6146 buffer doubler, two 4-250A RF drivers, four 3X2500F3 power amplifiers, two 6SJ7 audio amplifiers, two 807 amplifiers, two 845 driver amplifiers, four 3X3000A3 modulators, twelve 673 rectifiers, two 866/866A modulator bias rectifiers, two 8008 PA bias rectifiers and two 8008 low voltage rectifiers.
- RESPONSE**— $\pm 1\frac{1}{2}$ db 50-10,000 cycles.
- NOISE**—55 db or better below 100% modulation.
- DISTORTION**—3% or better 100-5000 cycles. 4% or better 50-7500 cycles.
- KEYING**—400 WPM or less, as required. Also provision for frequency shift keying (see FSK units elsewhere in this catalog—see index).
- SIZE**—210" wide, 78" high, 49" deep. Door swing 40".
- WEIGHT**—Approximately 23,000 lbs. packed.
- CUBAGE**—720.



Ordering Data

Complete 20 kw high frequency broadcast transmitter, 4-22 mc, less tubes and crystals. Cat. HF-20B

Complete 20 kw high frequency broadcast, voice and telegraph transmitter, less tubes and crystals. Cat. HF-20BX

Complete 20 kw medium frequency broadcast transmitter for any frequency between 550 and 1600 kc, less tubes and crystals. Cat. BC-20B

Complete 20 kw telegraph transmitter (modulator and modulator power supply removed), 4-22 mc, less tubes and crystals. Cat. HF-20TX

100% set of tubes for HF-20B, HF-20BX or BC-20B. Cat. TK-139

100% set of tubes for HF-20TX transmitter. Cat. TK-140

CRYSTALS—Order H17 in JKO-2 temperature controlled oven (see index under Crystals) for all high frequency models. Order JK57M to frequency for BC-20B.

Low Frequency Homing Beacon

(25-400 watts 200-800 kc)

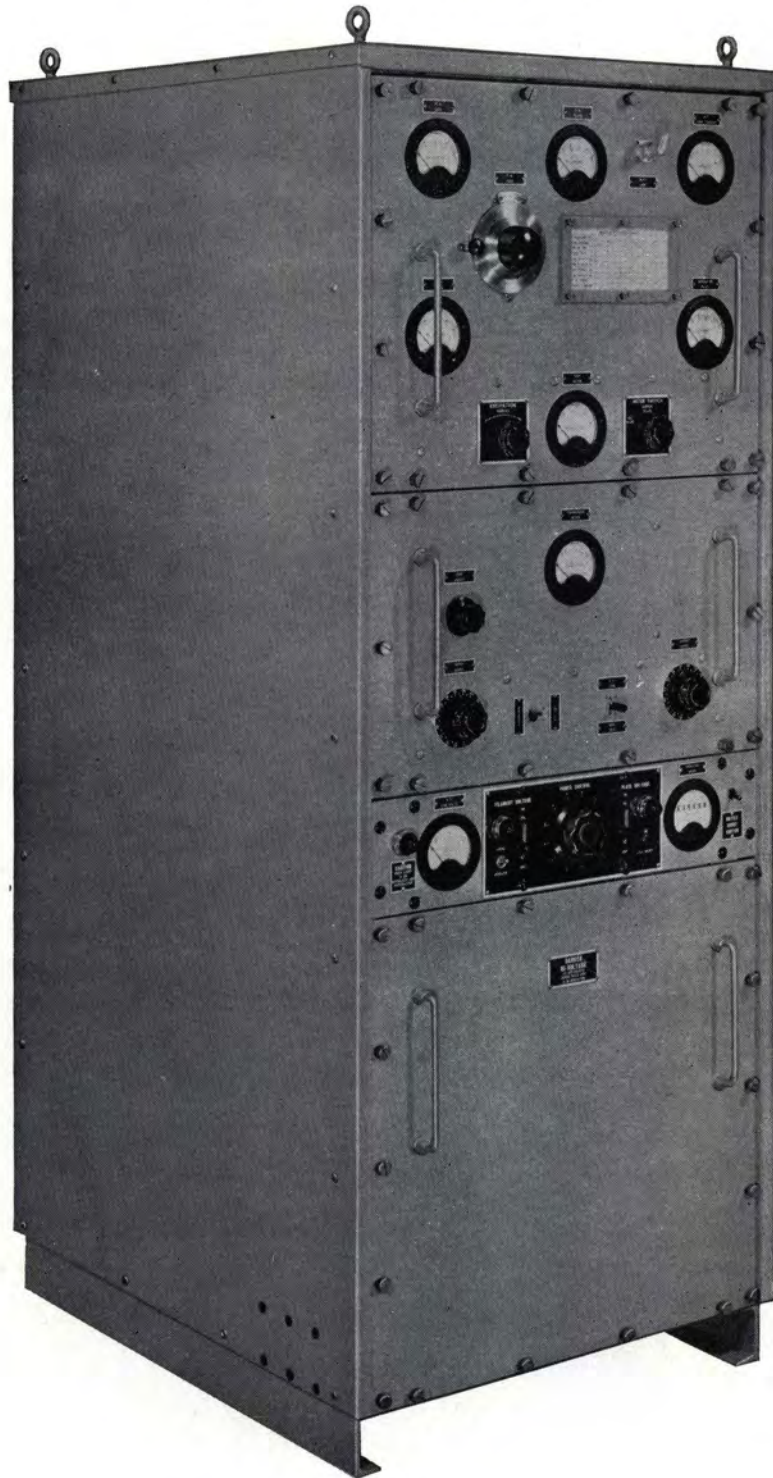

Fig. 1

The newest in low frequency homing beacon equipment is this Gates variable output transmitter with associated antenna coupling equipment, remote control station, and automatic keyer. Because of the variable power selector, standardization for short, medium, or long distance requirements through one design of equipment, lower maintenance costs and greater reliability is accomplished. Designed for around the world climatic conditions.

HOMING BEACON 400 WATT TRANSMITTER

(250-800 kc)

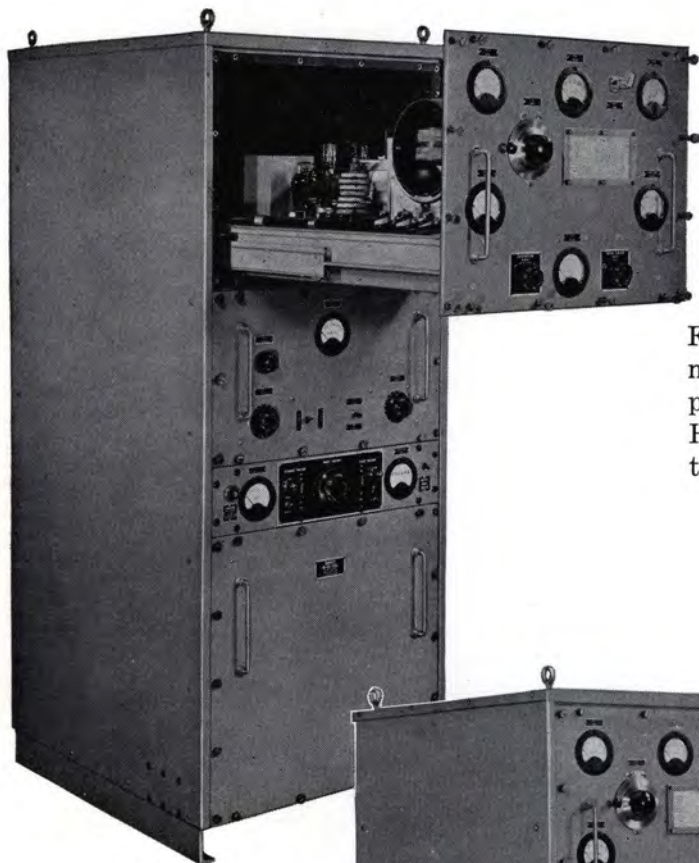

Fig. 2

Fig. 2 — illustrates Gates MO-3975 transmitter with complete radio frequency section pulled out for upper and lower servicing. Heavy roller bearing compound extension type slides are employed.

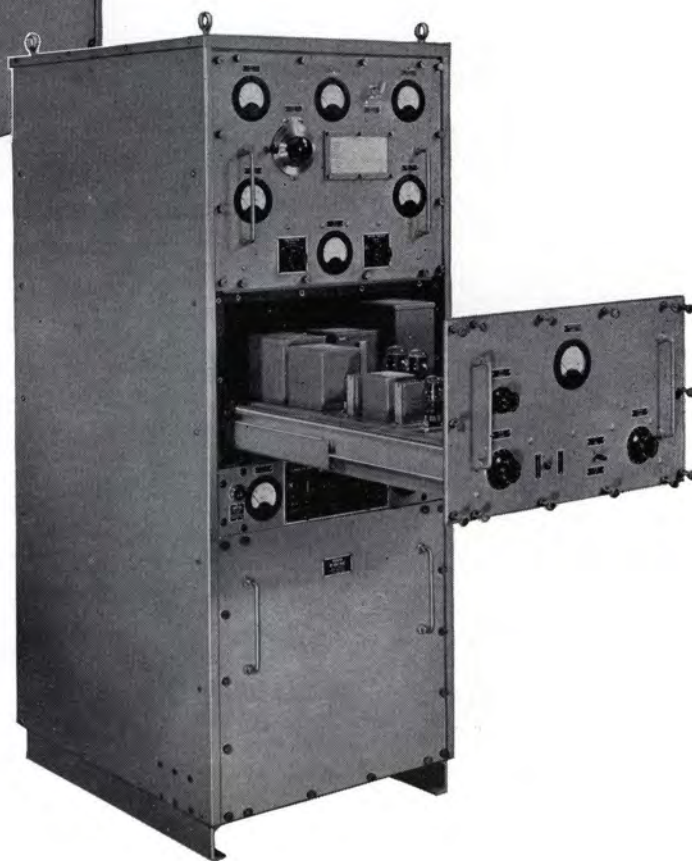

Fig. 3

Fig. 3 — illustrates audio deck pulled out for complete servicing, tube replacement and quick setting of code keyer. Control panel directly below hinges down to service relays.

VARIABLE OUTPUT 25 TO 400 WATTS

(for homing beacon service)

The Gates MO-3975 low frequency homing beacon transmitter is designed for operation at any carrier power up to 400 watts. Carrier power is adjustable down to 25 watts by means of a tapped auto transformer controlled with a heavy tap switch on front of the transmitter. Pressurized forced air cooling is provided.

High level modulation is employed, along with a complete audio system incorporating a peak limiter to prevent over-modulation, and a type 36 code keyer operating from a phase shift type audio oscillator at 1020 cycles.

General construction is to JAN specifications, in heavy steel frame to which each drawer section is secured by captive thumb screws. Design is heavy enough to stand Class "B" shock tests and operate in ambient temperatures between -54° C. and $+65^{\circ}$ C. —Automatic reset of the carrier provides

4 instantaneous recycling periods before turn off. Transmitter may be reset from the switch provided on the remote control unit. (Fig. 4).

Xenon gas type high voltage rectifier tubes are employed to permit operation in extremely low ambient temperatures. — RF output is 51.5 ohms unbalanced, which may feed into coupling unit of purchaser's design or the Gates MO-4116 tuning unit (Fig. 5) which is designed to couple into T type antenna 200' on the horizontal and vertical lead heights from 15 to 50 feet.

The remote unit consists of complete speech amplifier along with transmitter off-on switch. Amplifier is provided with decibel meter, level control and dynamic microphone of 50 ohms impedance attached to push-to-talk desk stand. — Designed either for desk or rack mount. Size: $10\frac{1}{2}'' \times 19'' \times 12''$.

ILLUSTRATION BY FIGURE NUMBER

Fig. 1—Operating view MO-3975 transmitter (Page 101).

Fig. 2—Transmitter with R. F. deck pulled out.

Fig. 3—Transmitter with audio deck pulled out.

Fig. 4—Remote control unit and speech amplifier.

Fig. 5—Antenna coupling unit for T antenna.



Fig. 4

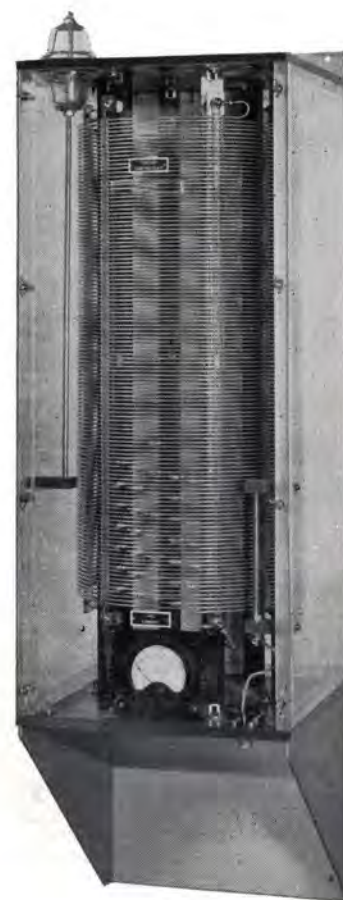

Fig. 5

GATES HOMING BEACON TRANSMITTER SPECIFICATIONS

CARRIER POWER—Maximum, 400 watts; minimum, 25 watts.

MODULATION—Class AB 1 high level—voice, or code wheel keying at 1020 cycles.

KEYER—Type 36 code keyer 8 RPM or equal to 4/6 WPM. Code wheel has 60 segments allowing for any three-letter identification with code signal. Segments are of stainless steel and adjustable with ordinary screw driver.

CARRIER RANGE—200 to 800 kc.

FREQUENCY STABILITY—0.005%.

AUDIO RESPONSE— ± 2 db 400-3000 cycles with sharp cut off at 3000 cycles and gradual roll off below 400 cycles for good voice quality.

NOISE—40 db below 100% modulation at 400 watts.

DISTORTION—6% or less 400-3000 cycles.

IMPEDANCES—Transmitter audio input 600 ohms at -10 db for 100% modulation at 400 watts. RF, 51.5 ohms output.

CONTROL—Local or remote by means of 3-wire cable or 600 ohm 2-wire simplex telephone line.

POWER CONSUMPTION—2200 watts at 115 volts, 60 cycles, single phase at full power output.

TUBES—5670 (2C51) crystal or VF oscillator; 6AC7 first IPA, 807 second IPA, 4-400A power amplifier, P.P. 4-250A modulators, P.P. 6SJ7 audio drivers, pair 4B32 xenon gas rectifiers, pair 5U4G low voltage rectifiers, 6X5GT bias rectifier and 6L6 clamp tube. — Remote unit, three 6SJ7 and one each 5U4G, VR105.

METERING—Individual 3" meters provided for: power line voltage, elapsed time, second IPA plate, PA grid, PA plate, modulator plate and RF output. — Single multimetering for crystal oscillator plate, first IPA plate and second IPA grid.

SIZE AND WEIGHT—Transmitter 72" high, 26" wide and 30" deep, closed. Added 24" from front to back with drawers out. — Weight packed, 1400 lbs., 60 cu. ft. Antenna coupler and speech unit not included.

Weight of remote unit, 80 lbs., 4 cu. ft.

Weight of remote antenna coupler, 120 lbs., 8 cu. ft.

- MO-3975 transmitter with tubes, less crystal. Code ZIDGK
- MO-4116 antenna coupler. Code ZIDIC
- MO-4033 remote control unit. Code ZIDOD
- MO-4124 microphone and desk assembly. Code ZIDUF
- JKO-2 oven with crystal to frequency. Code ZIDYG

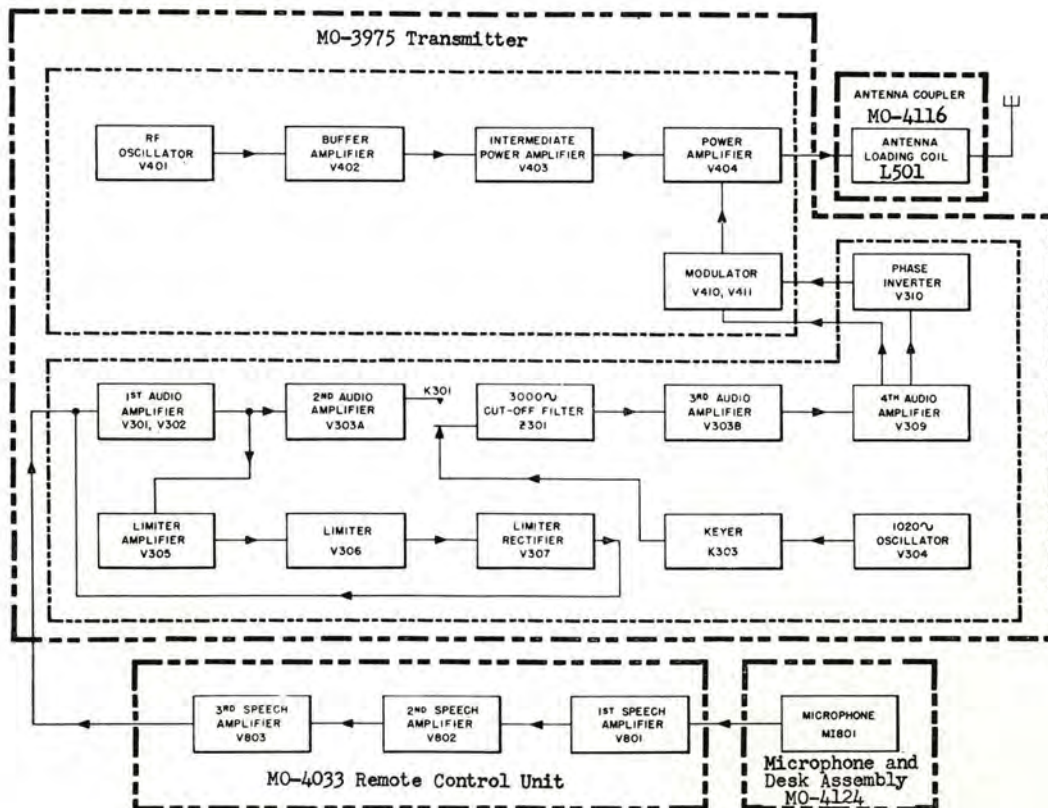

Low Frequency Homing Beacon, system signal block diagram

200 MC 3-5 KW Transmitter

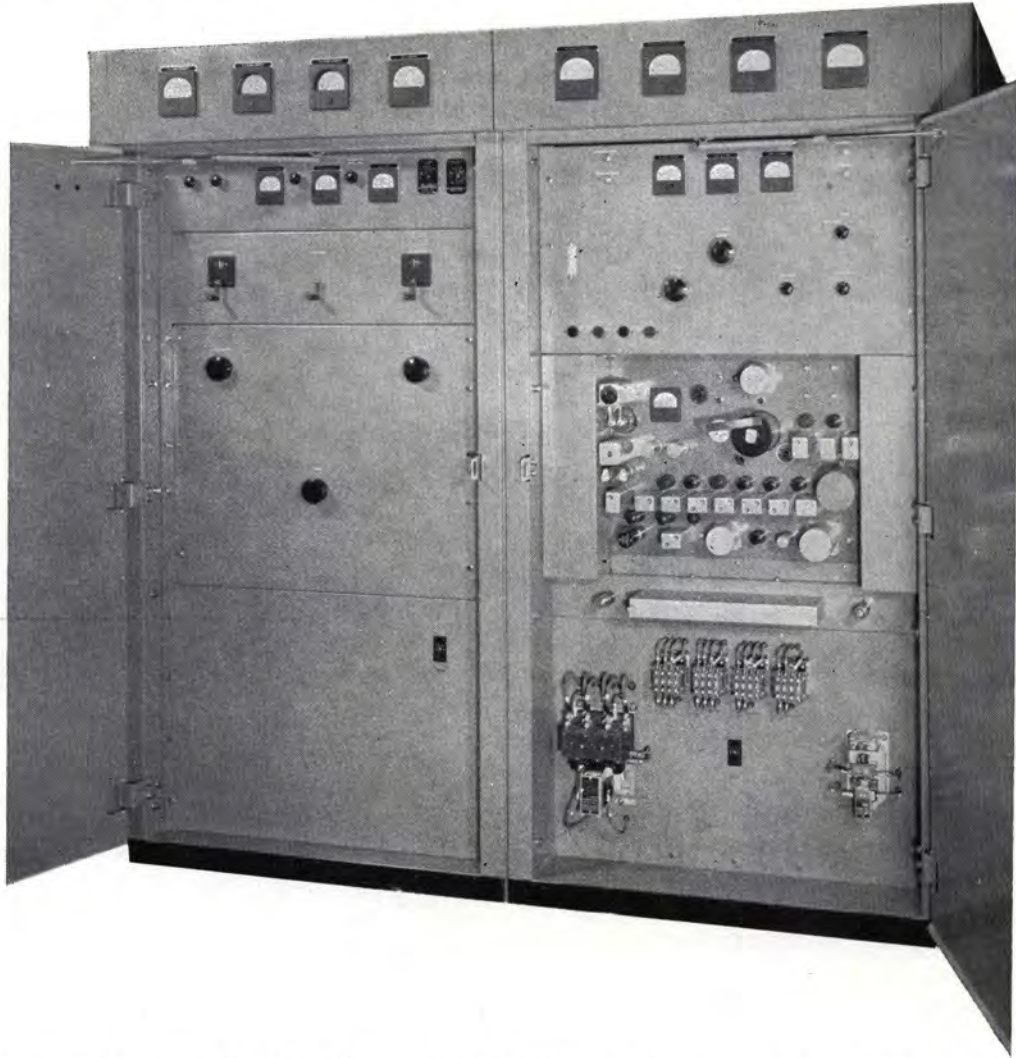

Illustrated on this page is the Gates FMX-3 VHF radio transmitter, FM modulated. This equipment is illustrated primarily to indicate special equipment that is regularly designed by Gates engineers and manufactured to specifications. This transmitter, designed for a research bureau of the United States Government, was used in measuring propagation between 175 and 216 mc and at powers up to 5 kw.

Similar equipment will be found useful where AM modulated, and a suitable modulator system can be provided, with power supply, by adding cubicles to the two shown. — The FBX-3 radio transmitter provides full 100 kc swing for high fidelity FM modulation. It is constructed in two cubicles,

each 42" wide, 78" high and 48" deep, making a total width of 84". Type 3X2500A3 tubes are used in push-pull in the final amplifier which couple to a 51.5 ohm line. Output is variable in power by means of a 3-phase auto transformer, continuously variable and operated from the front panel. Power output is rated 3 kw continuous duty, though power up to 5 kw may be employed either for ICCS or by acceptance of reduced power tube life.

Gates invites inquiries on special built VHF as well as UHF equipment. By reason of many years of association and manufacture of transmitters in the FM, television and communications fields, development charges are often greatly reduced by the application of previously made developments with additions or modifications. Field engineers in the Gates organization, as well as the extensive Gates engineering staff at our main plant in Quincy, Illinois, will be happy to consult with any prospective user of VHF or UHF equipment to determine how a specific problem can be solved at the least expense and with the very finest in equipment.

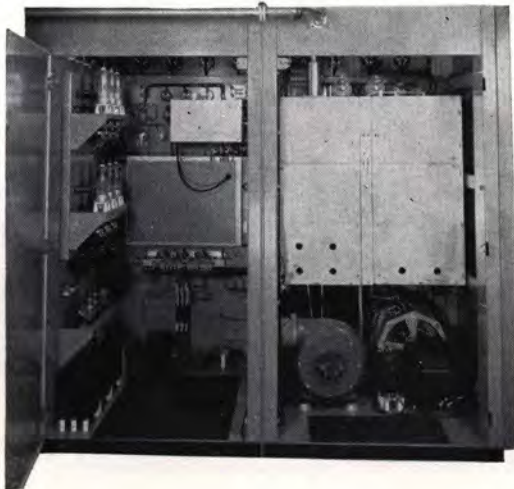

Low Power 2-Way FM Radio Telephone

These unusual equipments have a wide variety of uses, and FCC licensing is easily obtainable. For short point to point service, either indoor or outdoor, up to about three miles, with greater coverage depending on elevations. Manufactured by Hallicrafters.

LITTLEPHONE

This hand carry unit is a complete 2-way battery operated radio telephone equipment including transmitter and receiver, telephone set and antenna. It is available in two frequency ranges, and with either dry or wet batteries. Equipment is rugged and weatherproof. Transmitter uses ten sub-miniature tubes in Armstrong FM circuit. Receiver employs twelve sub-miniature tubes and duplicate crystal diodes in double conversion, crystal-controlled, superheterodyne circuit. Size with dry batteries: 8 $\frac{3}{4}$ " x 8 $\frac{1}{4}$ " x 3 $\frac{1}{2}$ ". With wet batteries: 11" x 8 $\frac{1}{4}$ " x 3 $\frac{1}{2}$ ". Weight: 10 to 14 lbs. Power output varies as to frequency—see below. Supplied complete with tubes, batteries, crystal, handset and detachable antenna. Frequencies are assigned by FCC domestically. Frequency must be known before shipment can be made.

Littlefone, dry battery operation, frequency range 25-50 mc at $\frac{3}{4}$ watt. Cat. HT-21LDS

Littlefone, wet battery operation, frequency range 25-50 mc at $\frac{3}{4}$ watt. Cat. HT-21LWS

Littlefone, wet battery operation, frequency range 25-50 mc at 2 watts. Cat. HT-21-HWS

Littlefone, dry battery operation, frequency range 150-174 mc at $\frac{1}{2}$ watt. Cat. HT-22-LDS

Littlefone, wet battery operation, frequency range 150-174 mc at $\frac{1}{2}$ watt. Cat. HT-22-LWS

Littlefone, wet battery operation, frequency range 150-174 mc at 1 watt. Cat. HT-22-HWS



The Littlefone complete 2-way radio telephone set.

CENTRAL STATION

A complete stationary 2-way station, with built-in power supply, for 115 volts, 50/60 cycles. May be desk or wall mounted and is complete with microphone. Has built-in loud speaker. Size: 9"x11"x7". Weight: 21 lbs.

Central Station, frequency range 25-50 mc, output 2 watts. Cat. HT-23

Central Station, frequency range 150-174 mc, output 1 watt. Cat. HT-24



The Central Station 2-way radio telephone.

COMPANION RECEIVER UNITS

Where receivers only are needed, such as for monitoring, or where talk-back is not required, these receivers are specially designed for this service. They have two IF stages for sensitivity, headphone jack and built-in speaker. Size: 12 $\frac{7}{8}$ "x7"x7 $\frac{1}{4}$ ". For 115 volts, 50/60 cycles.

Receiver complete with tubes for 25-50 mc range. Cat. S-82

Receiver complete with tubes for 150-174 mc range. Cat. S-81



The S-81 and S-82 receivers are used where sending is not required.

Frequency Shift Keying Equipment



The frequency shift keyer described herein, with its associate power supply, is a very high stability radio frequency oscillator which provides a means of shifting a radio frequency carrier in accordance with intelligence. This unit replaces the crystal oscillator in the transmitter, and produces "mark" and "space" carrier shift for transmission of teleprinter or telegraph signals, or a linear carrier shift for the transmission of FM telephone, facsimile or telephoto.

The 105-4 unit consists of five main sections: a keying circuit, reactance tube, shifted oscillator, crystal oscillator, modulator and power amplifier. Particular attention has been given

to stability through an unusually accurate oscillator. Outstanding features include: a frequency shift dial that adjusts mark and space frequencies equally above and below the carrier position; a simplified frequency setting which develops only upper side band indication on the meter over most of the tuning range; direct reading frequency calibration of shift from 0-1000 cycles; direct reading frequency calibration of mixer and output tuning indicators from 2.5 to 6.7 mc; direct reading calibration of output frequency vernier ± 600 cps; no adjacent channel radiation and linear carrier shift up to 1000 cycles through the operating range of 2.5-6.7 mc. Manufactured by Northern Radio.

SPECIFICATIONS

- FREQUENCY RANGE—2.5 to 6.7 mc.
- POWER OUTPUT—3 watts into 50-75 ohm line.
- MONITOR OUTPUT—90-120 millivolts.
- KEYING SIGNAL—0 volts (space) and +15 to +150 volts (mark).
- INPUT IMPEDANCE—120,000 ohms.
- KEYING SPEED—150 dot cycles second.
- STABILITY—10 cps for ambient range 0° C. to +50° C. (mark and space freq.). 25 cycles for line voltage variations up to 10%.
- POWER REQUIREMENTS—115 volts, 50/60 cycles.
- TUBES—One each 2E26, 5U4G, 6X5GT, OC3/VR105, OA3/VR75, two 6SA7, four 6SN7.
- SIZE—Keyer 10½"x19"x11" deep. Power supply 5¼"x19"x9" deep.
- SHIPPING WEIGHT—88 lbs.

Frequency shift keyer with tubes and power supply. Cat. 105-4
Spare set of tubes for above FSK unit. Cat. TK-141

When ordering, state frequency of operation desired. Note that frequencies above 6.7 mc will be double or triple the crystal frequency.

Frequency and Shift Monitor



The frequency and shift monitor provides a secondary standard to measure frequency of radio transmitters and the amount of carrier shift. For measuring frequency shift of mark and space signal, either for set-up or during keying cycle, the 106-4 monitor is very valuable. — It is designed around a highly stable temperature controlled crystal oscillator and buffer stage, with provision to select any of ten crystals or an external oscillator. Wide band amplifiers develop output suitable for driving a harmonic generator. These harmonics are heterodyned with the amplifier RF input signal, and the difference frequency from

the detector is then amplified to the required level.

As many as ten separate transmitters may be monitored for both frequency and frequency shift. Where crystal frequencies are halfway between mark and space frequencies the carrier may be monitored when keying. This is very useful in low speed operation such as teleprinter. For higher speed keying, monitoring is through use of headphones and by adjusting for a steady tone. The frequency shift will then be twice that indicated on the frequency meter. Manufactured by Northern Radio.

SPECIFICATIONS

FREQUENCY RANGE—2.5-30 mc in 3 ranges, 2.5-5.7 mc, 5.7-13 mc and 13-30 mc.

CRYSTAL OVEN—Accommodates ten crystals. Input connection adjacent for external oscillator where desired.

FREQUENCY STABILITY—2 cycles per mc with power line variations between 105-130 volts.

FREQUENCY SHIFT RANGE—10-10,000 cycles.

RF INPUT LEVEL—100 millivolts or less.

RF INPUT IMPEDANCE—50 ohms or 470,000 ohms.

AUDIO OUTPUT LEVEL—10 volts or less at 10,000 ohm impedance.

POWER REQUIREMENTS—115/230 volts, 50/60 cycles.

SIZE—19"x10½"x14" deep.

TUBES—One each 6SN7, 6AL5, OB2, 5Y3GT, two each 6AU6, 6AQ5 and 6AH6.

Frequency shift and monitor system with tubes. Cat. 106-4

Spart set of tubes for above.

Cat. TK-142

When ordering, state frequencies to be monitored.

Frequency Shift Converter



Frequency shift converters are employed in the operation of a single or dual diversity receiver system of teleprinters. Frequency shift receiving systems usually operate from the output of two diversity receivers to convert the mark and space tones into DC pulses capable of operating a teletypewriter, tape recorder or any other device requiring DC pulses. This converter may also be used for reception of make and break CW signals.

In each channel the received audio tones are limited, amplified, discriminated and rectified.

Channels are then diversity combined, and the resultant is fed into push-pull DC amplifiers, with the DC output either polar or neutral, as desired. Though ease of operation is perhaps the dominant feature, other important features are: dual limiter tubes provide 50-60 db limiting of each channel, the 2" oscilloscope pattern permits tuning the receivers and converter for maximum performance, tone amplification after discrimination permits high level discriminator rectifier output, and the high level DC pulse signals are limited so that drift or variations of shift of the incoming signal can be tolerated to a considerable degree.

SPECIFICATIONS

INPUT IMPEDANCE—600 ohms.

INPUT LEVEL— Minus 20 to plus 30 VU.

INPUT FREQUENCY SHIFT LIMITS—100-1000 cps frequency shift.

OUTPUT—(1) polar DC pulses of 60 ma in 1800 ohms, (2) neutral DC pulses of ± 30 ma in 1800 ohms, (3) may be operated into any impedance 100-100,000 ohms.

KEYING SPEED—Up to 600 WPM.

POWER—110/220 volts, 50/60 cycles.

SIZE—19"x7"x15" deep.

TUBES—One each 2AP1-A, 6H6, two each 6SN7, 6SL7GT, 6SL7, 6L6 and four each 6H6GT, 5W4/5Y3GT.

WEIGHT—50 lbs.

Frequency shift converter with tubes.

Cat. 107-2

Complete set spare tubes for above.

Cat. TK-145

Variable Master Oscillator

(2-32 megacycles)



Here is an unusually stable master oscillator for use with high frequency transmitters. Self-contained is a 100 kc crystal for spot calibration of the variable master oscillator. A crystal oscillator is also provided which may be switched in, in place of the master oscillator. Three crystals may be accommodated to supply three crystal frequencies. Range is from 2-32 mc, either master or crystal oscillator mode of operation. Basic operation is from 2-4 mc, with the inclusion of buffers and multipliers to arrive at the entire 2-32 mc range. Output is

2 watts up to 4 mc and $\frac{1}{2}$ watt from 4-32 mc.

The 115-1 variable master oscillator is completely shielded and is built along laboratory standards. The design is such that it may also be used with diversity receivers. Calibration curves are provided for reading within 50 cps/mc. The built-in, high stability 0.1 mc crystal provides many check points for HF0 calibration. Dial calibration is to 1/100 turn, and quick frequency change can be made through simple pre-logging methods.

SPECIFICATIONS

High Frequency Oscillator

OUTPUT RANGE—2-32 mc continuous range.

CRYSTAL FREQUENCIES—Three provided 2-4 mc (as ordered for desired output to 32 mc).

OUTPUT IMPEDANCE—72 ohms.

OUTPUT LEVEL—2 watts to 4 mc and $\frac{1}{2}$ watt above 4 mc.

OUTPUT VOLTAGE—Sinusoidal at all output frequencies.

BF Oscillator

FREQUENCY RANGE—450-475 kc.

OUTPUT LEVEL— $3\frac{1}{2}$ volts across 1000 ohms with adjustable level control.

General Detail

SIZE—19"x10 $\frac{1}{2}$ "x14" deep.

WEIGHT—54 lbs.

TUBES—One each OA2, 5Y3GT, 6BE6, two each 12AU7, three each 6C4 and four 6AQ5.

STABILITY—HF master oscillator, ± 20 cps/mc for ambient change of +25 or -25 (from 0° to 50° C.) for any 8-hour period. 5 cps/mc $\pm 10\%$ line voltage change. Effect of tube change 50 cps/mc average to 150 cps/mc maximum. Will reset to 20 cps/mc to previously logged frequency.

Variable master oscillator with tubes. Cat. 115-1
Spare set of tubes for above. Cat. TK-144

Frequency-Modulation Monitor

(for FM monitoring)



To indicate frequency deviation between 25 and 175 mc, the new FD-12 monitor, manufactured by James Knights, will meet all FCC requirements for some radio broadcasting and all communications. Actually, operation is in four bands and the only change between bands is by means of plug-in antenna coils. These bands are: 25-50 mc, 72-76 mc, 152-162 mc, plus a fourth band as desired by the buyer.

Direct reading of modulation up to 20 kc, along with an adjustable peak flasher, will indicate modulation at both positive and negative peaks. Sensitivity for measuring is 1000 microvolts or less across the antenna terminals. — Standard model is rack mount design, 8 $\frac{3}{4}$ "x19"x14" deep. It is available with desk cabinet, as illustrated, where desired. A 500 ohm output circuit is provided for monitoring, which also may be used for measuring distortion of the FM transmitter in conjunction with a distortion meter. Operates on 115 volts, 50/60 cycles. Power consumption, 80 watts. Shipping weight, 70 lbs. State frequency when ordering.

Frequency and modulation monitor for FM, with tubes.

Cat. JK-FD-12

Desk cabinet for above monitor, as illustrated.

Cat. DL-128

Complete set of spare tubes for above monitor.

Cat. TK-147

If It's Not In This Catalog

If you are one of those folks who starts at Page 1, then you are about halfway through this catalog. — Still to come, on the following pages, is a host of equipment and parts, both large and small. — If you have not found what you are looking for, there is every chance it may be on pages to follow. If, after reading through all these pages, you still do not find what you want, then two sections of the Gates company are ready to go to work for you. One of these is our specialties department. This section will design and manufacture anything within the general scope of products listed herein. The second department of Gates, the purchasing section, will go to work and try to find anything for you, no matter how hard to get or what the price might be, and regardless of whether or not there is profit in the transaction. — Make Gates your one source for everything in the commercial electronic field... even if you do not find it listed on the pages of this catalog.

CRYSTALS AND OVENS



JK STABILIZED H-4

Frequency Range 1800 kc to 20 mc.
Holder Material Black Phenolic.
Pressure Mounting, Stainless Steel Electrodes.
Water and Dust Proof.
Military Type HC1/U Holder.

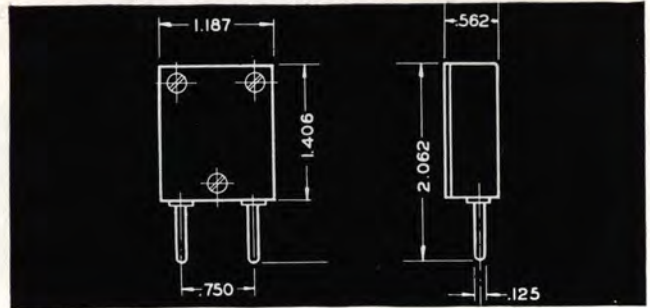

JK STABILIZED H-17, H-17L, H-17W

Frequency Range 200 kc to 100 mc.
Hermetically sealed metal holders.
Wire mounted, silver plated crystals.
Two type H-17 holders fit octal socket, 2 type H-17L holders fit octal socket, H-17W has RMA Standard pigtail leads. H-17 is military type HC6/U, CAATC No. 3R1-3.

H-17L not recommended for new equipment design. We recommend the H-17.

JK STABILIZED H-17T, H17TL

Frequency Range 20 kc to 200 kc.
Hermetically sealed metal holders.
Wire mounted, silver plated crystals.
Two type H-17T holders fit octal socket, two type H-17TL holders fit octal socket. H-17TL not recommended for new equipment design. We recommend the H-17T.



H-17



H-17L

These crystals and holders may be inserted in the JKO-2 and JKO-2T ovens, described on opposite page, with greatly improved stability.

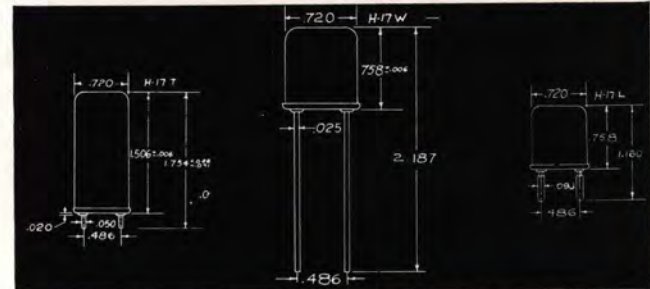
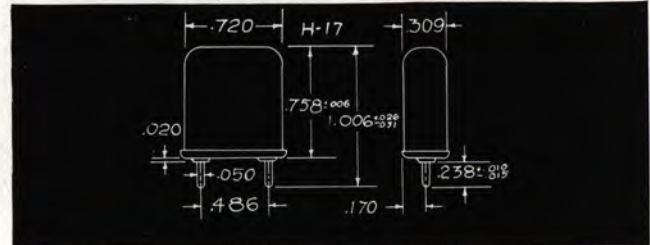

JK STABILIZED H-22

Frequency Range 50 kc to 150 kc.
Hermetically sealed metal holder.
Wire mounted, silver plated crystal.
Largest holder that will go in JK07 oven.
Ideal for frequency standards.

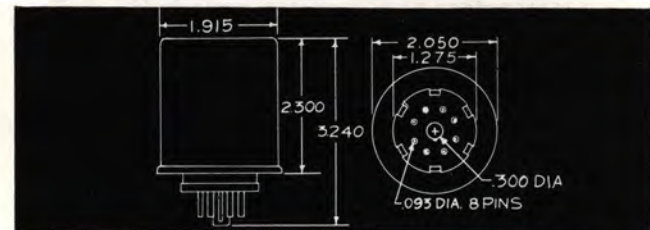

BROADCAST CRYSTALS AND OVENS

Designed for broadcast service, and available with or without thermometer. Frequency range 400-1750 kc. Adjustable to $\pm 0.01\%$. Normal temperature 60°C . Ambient range 60°C operation, -20° to $\pm 58^\circ\text{C}$. Fully FCC approved for broadcast service. Model JK57 for standard 5 pin socket and JK87 for octal socket. State frequency when ordering. Order JK57M or JK87M where no thermometer desired. Order JK57MT or JK87MT with thermometer.

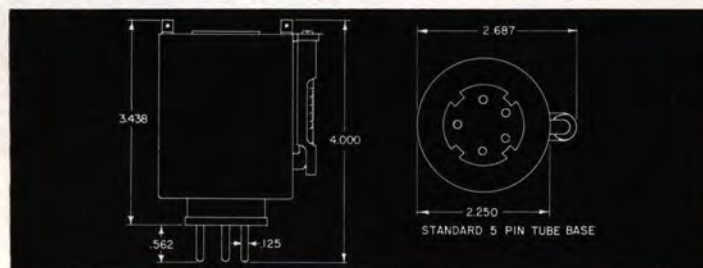

CRYSTALS AND OVENS

JK STABILIZED HEAT JKO-2

Holds two type H-17 units (Military HC6/U).
JKO-2T holds two type H-17T units (MIL HC-13/U).
Normal temperature $75^{\circ} \pm 5^{\circ}$ C.
Ambient range— 55° to 70° C.
Heater 6.3 volts, under 1 amp.
JKO-2T draws 1.4 amp.
Standard octal base.

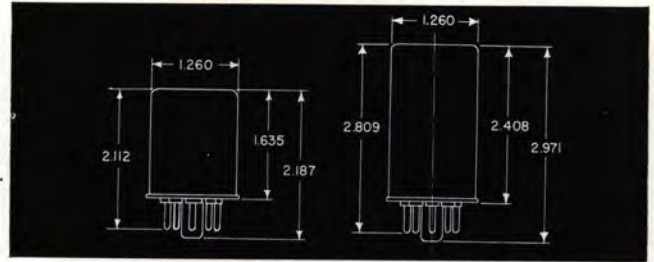

JK STABILIZED HEAT JK07, JK07E

Will hold any JK type crystal except H-6, H-18T and H-19.
Normal operating temperature 50° C. $\pm 2^{\circ}$ C.
Will hold temperature as much as 75° C. above the ambient.
Supplied complete with Johnson No. 237 socket.
JKO-7E has sealed-in glass thermostat for greater precision and longer life.
Available as JKO7 or JK07E with 6.3 volt 10 watt heater or 115 volt 12 watt heater on either model.
Ideal for frequency standards and broadcast (FM & TV) FCC approved.

JK STABILIZED G-9, G-9J

Frequency range 1.20 kc to 300 kc.
Hermetically sealed glass holder.
Wire mounted, gold or silver plated crystals.
6V6GT envelope, octal base.
MIL HC-15/U.



This new unit is available at higher frequencies than listed above. Write us concerning any special application you may have.

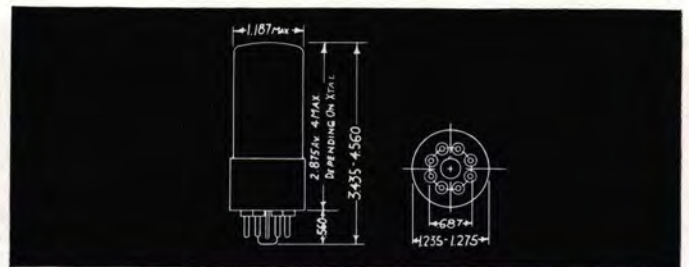
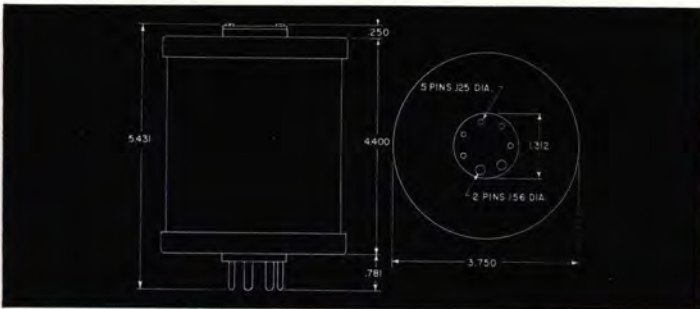

Frequency Standard

This is the famous JK Secondary Frequency Standard which is performing so excellently for Amateurs, Broadcasting Stations, Colleges, Police radio, Marine radio, Industrial Plants, servicemen and many others. Two hermetically sealed "Stabilized" crystals are used for frequency control (1000 kc and a 100 kc) which provide dependable, drift free, fundamental frequencies. Carefully designed circuits and components of the highest quality permit flexibility of operation found in equipment costing several times as much.

The frequency range of 100 kc to 40 mc in 100 and 10 kc steps and in 1000 kc steps from 1 mc to 500 mc (with a minimum of 15 microvolts output) provides a standard signal for almost any purpose.

Calibration

In the 1000 kc, 100 kc and 10 kc positions the complete unit has less than $1\frac{1}{2}$ cycles per megacycle per degree centigrade drift at normal operating temperature. By using care the accuracy of all output frequencies can be controlled to within two parts in 10 million over periods of time sufficiently long to permit measurement of any frequency within the range of the instrument. The unit has a button on the panel which is used to determine whether the signal being measured is above or below the standard frequency.

The JK Frequency Standard is a beautifully designed instrument in durable gray crackle finish. Dimensions: 12"x8"x8". Power Supply: 115 volts AC, 60 cycles. Complete with Tubes and JK "Stabilized" Crystals.

GATES RECOMMENDED RADIO RECEIVERS



Models S40B and S40BO

Here is a fine receiver with superior performance in the medium price field. Has loudspeaker self-contained. Band width from 540 kc to 43 mc with temperature compensated oscillator. Has one RF and two IF stages. Tubes: 6SG7 RF amp., 6SA7 converter, two 6SK7 IF amps., 6H6 ANL and AVC, 6SL7 BFO and Det., 6F6G output and 5Y3GT rectifier. Size: 18½"x8⅞"x9½" deep. Made by Hallicrafters.

Receiver with tubes for 105/125 volts, 50/60 cycles. Cat. S40B

Receiver with tubes for 115/250 volts, 50/60 cycles. Cat. S40BO



Model S76 Receiver

In the Hallicrafters S76 receiver there is featured a double conversion circuit with 50 kc second IF stage and with 4" S meter. Continuous coverage from 538-1580 kc and 1.72 to 32 mc. Tubes: 6SG7 RF amp., 6SA7 converter, two 6SK7 IF amps., 6H6 ANL and AVC, 6SL7 BFO and Det., 6F6G output, 5Y3GT rectifier. Suitable loudspeaker for this receiver will be found in this catalog (see index . . . speakers).

Receiver with tubes for 105/125 volts, 50/60 cycles. Cat. S76



Model SX71 Receiver

Extra sensitivity, selectivity, stability and superior image rejection is provided in the Hallicrafters S71 receiver. A double superheterodyne circuit along with narrow band FM service makes this a fine receiver, ideal for both AM and FM communications. Continuous 539 kc to 35 mc AM coverage and 46-56 mc FM coverage. Image rejection 150-1 at 25 mc. Tubes: 6BA6 RF amp., 6C4 osc., 6AU6 mixer, 6BE6 second converter, three 6SK7 IF amps., 6H6 ANL and delayed AUG., 6SC7 BFO and AF amp., 6AL5 Det., 6K6GT output, VR-150 regulator and 5Y3GT rectifier. Size: 18½"x8⅞"x12" deep. Matching speaker in cabinet available as accessory.

Receiver with tubes for 105/125 volts, 50/60 cycles. Cat. SX71

Matching loudspeaker in cabinet for above. Cat. R46



Deluxe Model SX73 receiver is the finest of the fine, and will meet the most exacting requirements of the communications industry.

When Hallicrafters designed the SX73 they provided the communications industry with a product unequalled in their entire line. For ruggedness, sensitivity, stability, selectivity, restability, image and IF rejection, the SX73 has no peer. Continuous coverage from 540 kc to 54 mc. Dual RF and IF stages plus dual conversion above 7 mc. The 2nd beat oscillator is crystal controlled. Tube complement totals 17 tubes. Antenna input for a range of 50 to 200 ohms. Audio output 50 and 600 ohms. Operates from 115 or 230 volts, 50/60 cycles. This receiver was designed for the Military, and Gates recommends it for the most exacting service in voice, telegraph or teletypewriter service. For loudspeakers, see index of this catalog.

Receiver complete with tubes.

Cat. SX73

GATES RECOMMENDED RADIO RECEIVERS

AM/FM High Fidelity Tuner

Gates offers this high fidelity tuner for AM and FM broadcast reception, due to the demand of our many industrial customers for something better than the average in both quality of construction and quality in performance. The temperature compensation in the Hallicrafters ST-83 tuner is the very finest; and the reactance tube tuning control, which causes distortion due to inherent mistuning, is eliminated. Extreme care has been taken to assure absolute minimum drift. Range 535-1650 kc AM and 88-108 mc FM. Has accessory inputs for tape recorder, phono pickup or TV. Sensitivity for FM, 5 microvolts for 30 db quieting. For AM, 25 microvolts standard RMA dummy. Has 11 tubes. Output about 0 dbm into 10,000 or 600 ohms.

High Fidelity Receiver with tubes, for 115 volts, 50/60 cycles.

Cat. ST-83



A-84 HI-FI Amplifier

Through the A-84 amplifier is specifically designed to go with the ST-83 tuner listed above, it is ideal for any type of high fidelity reproduction, with or without the radio tuner. Frequency response is within 0.1 db from 10 to 40,000 cycles and within ± 2 db from 3 to 200,000 cycles. Power output 10 watts between 7 and 100,000 cycles at a harmonic distortion of less than $\frac{1}{4}\%$. Hum and noise 90 db below 15 watt level. Input impedance 470,000 ohms requiring $1\frac{1}{2}$ volts for full 10 watt output. Output impedance 8 and 16 ohms. Employs two of the British KT-66 output tubes along with two 6SN7GTA and one 5U4G. Protective cover has been removed from picture to the left for illustrative purposes. For quality loud speakers, see index of this catalog.

Ten watt HI-FI Amplifier with tubes, for 115 volts, 50/60 cycles.

Cat. A-84



HAMMARLUND SP600JX SERIES RECEIVERS



The SP600JX is a 20 tube radio communications receiver designed to the exacting requirements of the Military, and having all components, insofar as possible, meeting Military requirements. Though it is recognized that receivers, like other electronic devices, have varied preferences, it can be said that almost universal praise has followed the SP600JX where it has been used. — Continuous tuning in six bands from 540 kc to 54 mc. Power output 2 watts in a split winding and balanced 600 ohm circuit. Power supply operates at a wide variety of input voltages from 95 to 260 volts, 50/60 cycles. Sensitivity 2.3 microvolts over entire range, for an S-N ratio of 10 db at 20 mw output and with RF gain control at maximum. Image rejection 74 db over entire range. IF rejection at 600 kc 2700-1. AVC action constant within 12 db within any input between 2 to 200,000 microvolts.

For rack mount, size is $19'' \times 10\frac{1}{2}'' \times 16\frac{1}{2}''$ deep. Cabinet size, $21\frac{3}{8}'' \times 12\frac{3}{4}'' \times 17\frac{1}{8}''$ deep. Tubes: seven 6BA6 RF, IF and BFO amps., three 6C4 HF, 2nd conversion and BFO oscillators, 6AC7 crystal HF oscillator, two 6BE6 mixers, three 6AL5 Det., C bias rectifier and noise limiter and meter rectifier, 12AU7 AF and IF, 6V6GT output, 5R4GY rectifier and OA2 regulator.

Receiver complete with tubes.

Cat. SP600JX

Cabinet for above receiver for desk use.

Cat. CAB14

DUAL DIVERSITY RECEIVER SYSTEMS



Dual diversity receiving systems, manufactured for Gates by Northern Radio, are available in several different combinations. A basic receiver rack cabinet consists of: two specially designed receivers with self-contained power supplies, a master crystal oscillator unit, an IF monitoring panel, modulation selector panel, and the rack cabinet with interwiring.

Additional units may be added as required in the particular mode of operation desired. These are: a frequency shift converter, a demodulator and a tone keyer. — The high frequency and beat frequency oscillators of each receiver are supplied by the master oscillator so that reliable performance is possible without retuning. This feature is very valuable when conditions demand use of the crystal filters in the receivers, as well as when frequency shift signals are received. Receivers may be operated separately when desired.

A frequency range of 540 kc to 54 mc in six bands, along with excellent power output for speaker service, and an image rejection of 80 db or better, plus many other refinements, make this diversity equipment highly desirable for the better communications system. Because diversity receiving systems vary, Gates invites your specifications, from which a quotation will be prepared promptly.



TUBELESS MODULATION MONITOR

Excellent for all voice operated communications transmitters. Has no tubes and uses germanium crystals. Meters are 3" square case, indicating carrier level and modulation percentage directly. Will read both positive and negative peaks. Size: 3½"x19".

SPECIFICATIONS

MODULATION INDICATION—Reads 0-110% modulation and in decibels.

ACCURACY—2% at 100% modulation and 5% mid-scale.

FREQUENCY RESPONSE—Within 2 db 50-10,000 cycles.

INPUT—Requires about ¼ watt. Input voltage 20V at 1000 kc or less.
Input capacity 15 mmfd.

RF RANGE IN TWO MODELS—2 to 30 mc and 25 to 150 mc.

Modulation monitor complete, 2-30 mc range. Cat. M-3737

Modulation monitor complete, 25-150 mc range. Cat. M-3738

Selective Amplifier or Heterodyne Filter



In receiving of high frequency signals, the heterodyning of two closely associated incoming signals, or two receivers beating at an audio rate, is very much a problem of prime consideration. The Gates M-3922 selective amplifier or heterodyne filter will, as long as the tone remains constant, eliminate single audio frequencies between 20 and 20,000 cycles. Where several tones are present, M-3922 filters may be placed in series and each undesirable tone reduced or changed so that readability is greatly improved.

Principle of operation is that of a selective audio filter. Connection is usually made ahead of the audio system in the receiver, though by insertion of a fixed pad it may be connected to the high level output of a receiver (600 ohms). In this case, an additional amplifier would be required to bring the signal back up to loudspeaker level. Tone rejection coverage between 20-20,000 cycles is by means of a calibrated dial, three position multiplier switch, plus coarse and fine adjusting controls. Level control allows control of audio level. Pilot light, fuse, and starting switch complete front panel facilities.

SPECIFICATIONS

- INPUT IMPEDANCE—600 ohms.
- INPUT LEVEL—Approximately 0 VU.
- FREQUENCY RESPONSE— ± 1 db 20-20,000 cycles.
- DISTORTION—1% or less 30-15,000 cycles at +18 dbm.
1½% or less 20-20,000 cycles at +18 dbm.
- NOISE—70 db or better below +18 dbm.
- REJECTION—At least 40 db up to 220 cycles and 50 db or better from 220-20,000 cycles.
- TUBES—Three 6SJ7, four 6SN7, one each OC3/VR105, OD3/VR150 and 5Y3GT.
- SIZE—5¼" x 19" x 16½" deep.
- POWER—115 volts, 50/60 cycles at approximately 60 watts.
- SHIPPING WEIGHT—35 lbs.

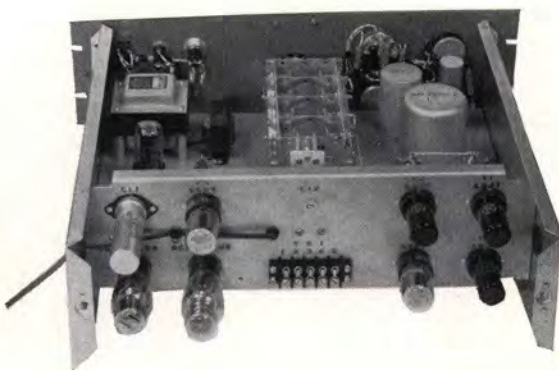

Selective amplifier or heterodyne filter with tubes.

Cat. M-3922



Gates speech input equipment is well known to radio and TV broadcasters everywhere. Over thirty years ago the first piece of Gates audio gear was offered to the industry. Since that day, Gates speech input apparatus has been found wherever fine broadcasting stations operate.

The above photo — WGEM, Quincy, Ill. — illustrates the result of much time and study by our engineering department. The critical eye will note transcription equipment behind the control console. Certain simple remote control functions made this possible, thus utilizing all available floor space and retaining finger tip control. — Gates personnel will gladly assist any TV or AM station in audio planning; in fact, they get a great deal of pleasure in so doing.

SPEECH INPUT EQUIPMENT

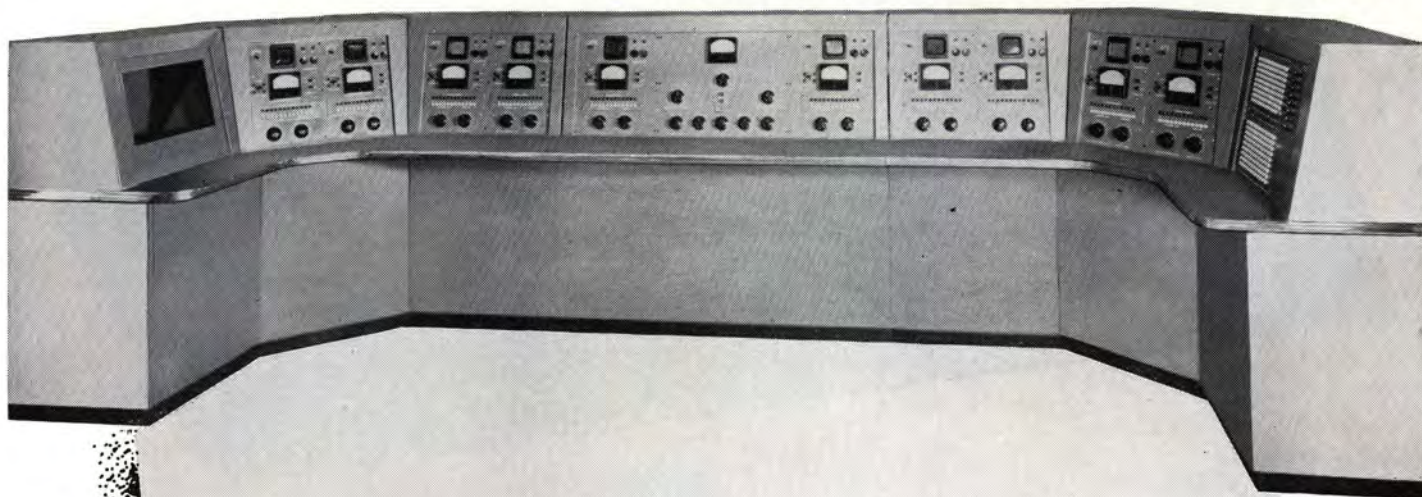
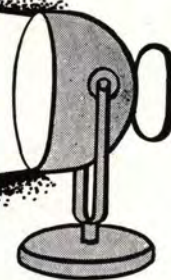

Since 1922 Gates speech input equipment has been known for quality in workmanship and performance. — Gates engineers have developed many of the circuit and control ideas that are now considered standard practice in radio, television, and wherever audio equipment is used.

The following pages describe modern, up-to-the-minute designs. We feel, no matter what price range you may require, there is a complete speech input system or individual accessory that will meet the technical requirements of the most exacting engineer.

Gates also manufactures many custom built speech systems, such as the elaborate master control desk pictured above. Whatever your speech input needs might be — Gates is ready to serve you.

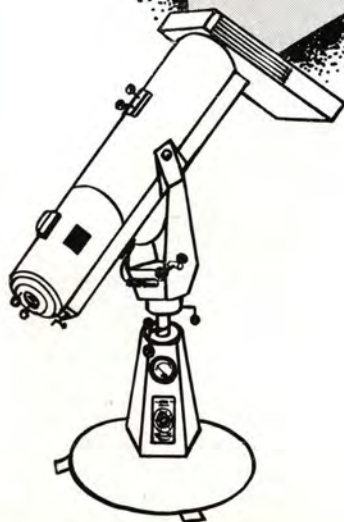

GATES

Model CC1 Speech Input Console



After lengthy study of TV production techniques and technical requirements suggested by leading TV engineers, Gates designers have provided what we believe to be a speech input console that will meet all requirements. The low, functional design allows finger tip control without operator fatigue. Circuit functions are more extensive; yet, simplicity of control has been retained.

This distinctive audio equipment will handle the technical and production requirements of the larger TV operation; yet, by reason of plug-in design, the purchaser need only procure the number of amplifiers needed—thus, making the cost within any budget. Later expansion means adding amplifiers—and with everything plug-in, it is just that simple. — After reading the several following pages, we believe you, too, will agree that the Gates CC1 console is the finest.

— 100% Plug-In and All New for TV

(features)

- Ten mixing channels, knobs color coded.
- 100% plug-in, amplifiers and power supplies.
- Accommodates 10 plug-in preamplifiers, but purchase only the number needed.
- Dual VU meters, illuminated.
- Cue position all 10 mixing positions.
- Three muting relays with provision for 3 more, if needed.
- Single or dual operation, as desired.
- Dual sub-master gain controls plus master gain.
- Patch panel termination facilities all major circuits.
- Channel markers for each mixing position.
- Hinged front panel.
- Complete remote, cueing and override facilities.
- A new high in performance standards and workmanship.

Complete description of plug-in amplifiers will be found on Pages 127 to 133.

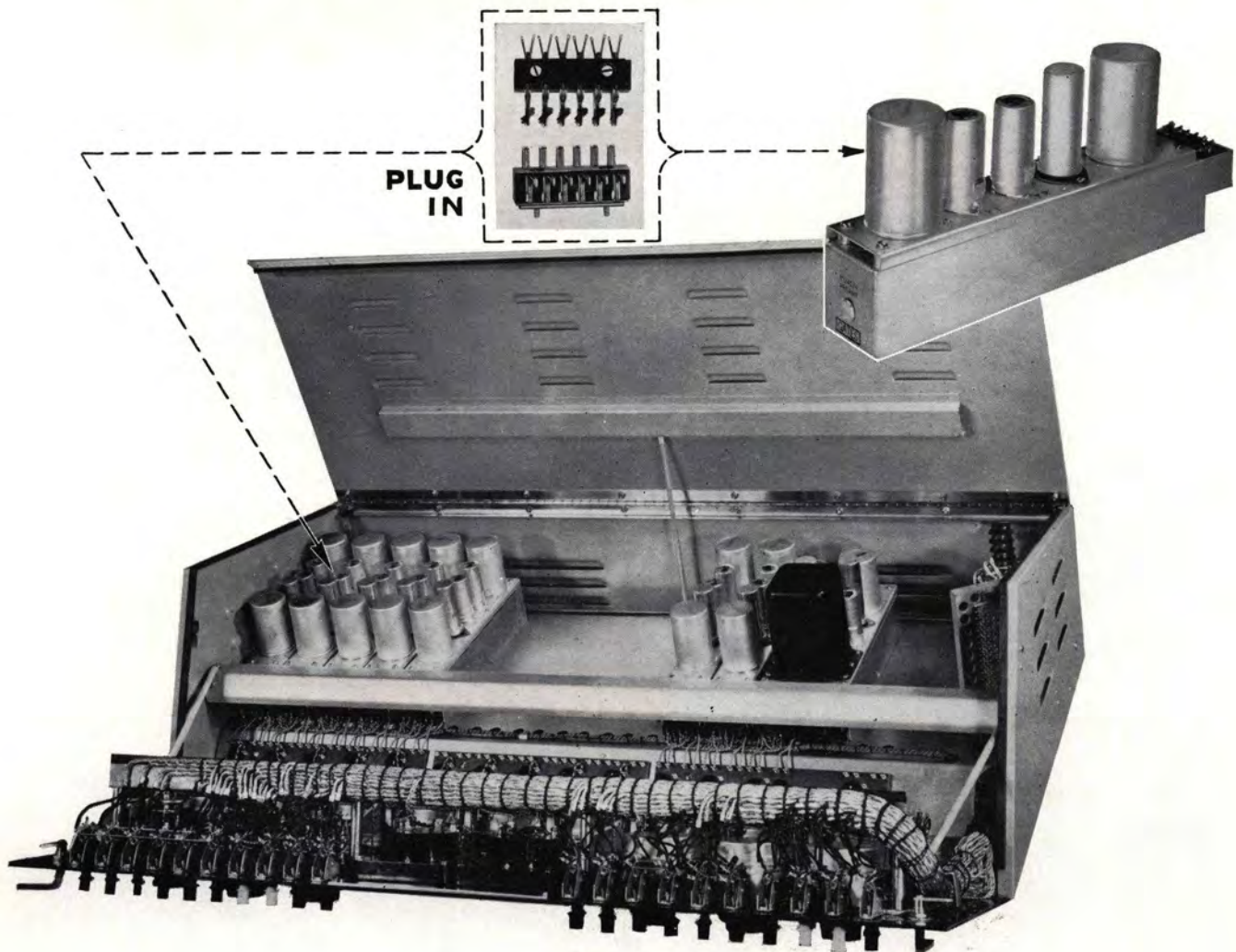

Gates CCI console equipped with 5 preamplifiers, duplicate booster amplifiers and single line amplifier. — Power supplies, monitor amplifier and relay panel mount separately on one panel and shelf assembly, requiring only 7"x19" of panel space.

FOR TV UP TO TEN CHANNELS---Excellent for AM also

(Model CC1 Console)

In over three decades that Gates has been making audio equipment, leadership—not only in performance but in the incorporation of new ideas—has continually made Gates the first choice. — The new CC1 console is bigger, circuitwise and facilitywise. It is smart and businesslike in appearance. Servicing ease is so pronounced that no more could be accomplished in this phase of the design. Hinged front panel, all terminations top side, no underwiring, and plug-in amplifiers throughout, magnify the minute time needed to reach any part.

In the CC1 console proper are accommodations for 10 plug-in preamplifiers and 2 plug-in program amplifiers. You buy only the required number of preamplifiers. Add more later when required. One program amplifier is standard equipment. Add the second if you wish dual channel operation. No wires to change—just plug them in.

The two power supplies, monitoring amplifier, and relay unit plug into the PAS1 panel and shelf assembly, which may be rack or otherwise mounted. A plug-in bias supply, which is part of one of the power supplies, provides fixed bias for the low distortion monitoring amplifier.

Two VU meters are standard. One of these indicates program amplifier No. 1 output. The second may be selected to: (a) program amplifier No. 2, (b) monitor amplifier, and (c) program amplifier No. 1. The latter is in conjunction with a six-position range switch from +4 to +30 VU. Muting relays may be energized in any combination at the infinity position, the output of which may be connected to a Gates SA-22 cueing amplifier or similar (see index for SA-22). Keys above each attenuator are of PBX type, and select each mixing channel into choice of two program circuits (see functional diagram, Page 124).

SPECIFICATIONS

MIXING CHANNELS—Ten.

NUMBER OF PREAMPLIFIERS—Up to ten.

GAIN—From preamplifier input to program line output, 106 db.

From line input to program line output, 65 db.

Monitor gain, 100 db. (properly padded where used for bridging).

RESPONSE— ± 1.5 db, 30-15,000 cycles.

DISTORTION—0.5% from 30-15,000 cycles at +18 dbm.

NOISE—70 db below -18 dbm output with controls set for gain of 68 db.

CROSS-TALK—Lower than noise level at all frequencies.

MONITOR OUTPUT—8 watts 3% or less distortion. 4/8/16/150 and 600 ohms.

PROGRAM OUTPUT—150 and 600 ohms.

INPUT IMPEDANCES—Preamplifiers 150 and 600 ohms. Remote channel 150 and 600 ohms. All others 600 ohms.

REMOTE LINES—Provision for six, with facilities for cueing, monitor listening and phones listening.

SIZE— $39\frac{1}{4} \times 21\frac{1}{2} \times 11\frac{1}{8}$ " at highest point. Panel slope 30°.

TUBES—See tube complement of individual amplifiers and power supplies, Pages 128 to 132.

POWER—115 volts, 50/60 cycles.

SHIPPING WEIGHT—Approximately 175 lbs. (less preamplifiers).

For further informative data please refer to functional diagram, Page 124.

Below, plug-in preamplifier, program amplifier, monitoring amplifier and power supply. These are described in detail on Pages 127 to 132.



— DUAL VU METERS, PATCH PANEL TAKE-OFF (Model CCI Console)

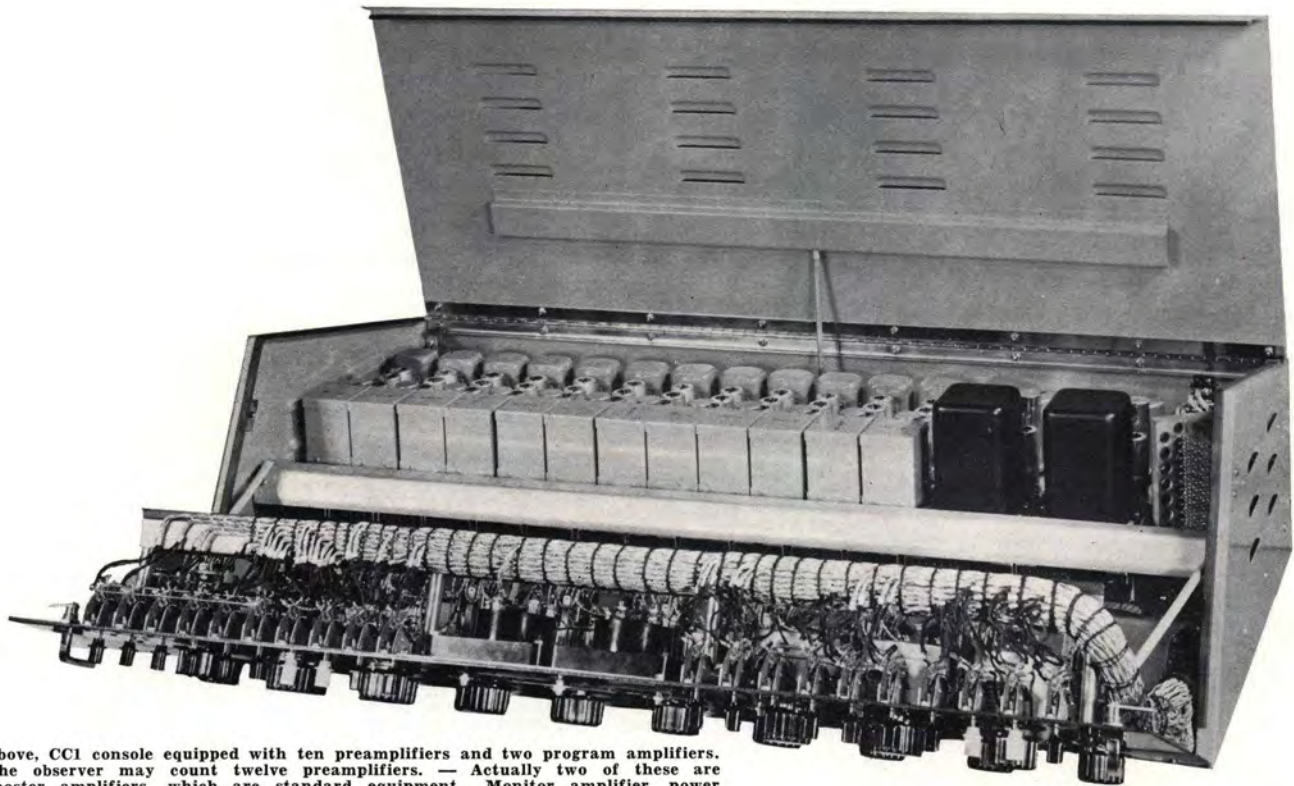

Above, CCI console equipped with ten preamplifiers and two program amplifiers. The observer may count twelve preamplifiers. — Actually two of these are booster amplifiers, which are standard equipment. Monitor amplifier, power supplies and relay panel mount on PASI panel and shelf assembly shown below.



Model PASI panel and shelf assembly holds power supplies, monitor amplifier and relay unit. Requires only 7" of rack panel space.



This front view, with panel dropped down, illustrates inner terminal arrangement for attaching external patch panel, where desired. The patch panel is not by any means a necessity in the console operation.



The CB-6300 desk has been designed for the CCI console. Has maroon micarta top molded to 5-ply base. All wiring to console is invisible through vertical trough on back of desk. Beautifully styled for modern surroundings, and finished in gray to match console cabinet. — Transcription turntables will fit properly to each side, if desired.

GATES CC1 SPEECH INPUT CONSOLE

(ordering information)

Model CC1 console is supplied with the following equipment as standard: two type PRE4 booster preamplifiers, one type PGM4 program amplifier, one type PAS1 panel and shelf assembly which accommodates the following units also supplied as standard: one type MON4 eight watt monitoring amplifier, two type PWR3 power supplies, one type PWR10 bias supply, one PRD1 relay assembly with three relays, one set of tubes for above, and instruction book. **Cat. CC1**

Preamplifiers with tubes, see Page 128 for full description. Order the number required for the above CC1 console. **Cat. PRE4**

Program amplifier, one supplied with above console. Provision is made for second program amplifier if dual operation desired. Full detail on Page 130. **Cat. PGM4**

Desk, as illustrated Page 123, ready to use. **Cat. CB6300**

Note: As standard, the CC1 console is provided with the MON4 eight watt monitoring amplifier. The Gates MON1 sixteen watt monitoring amplifier may be used as an alternate where greater power output is desired. See Page 131 for full detail. For pricing, deduct cost of MON4 amplifier and add cost of MON1 amplifier.

Important: When ordering, please note that the CC1 console is complete with exception of preamplifiers. To obtain the complete console, order type CC1 plus the number of preamplifiers needed. The booster preamplifiers supplied as standard are not microphone preamplifiers, but part of the subsequent circuitry of the CC1 console.

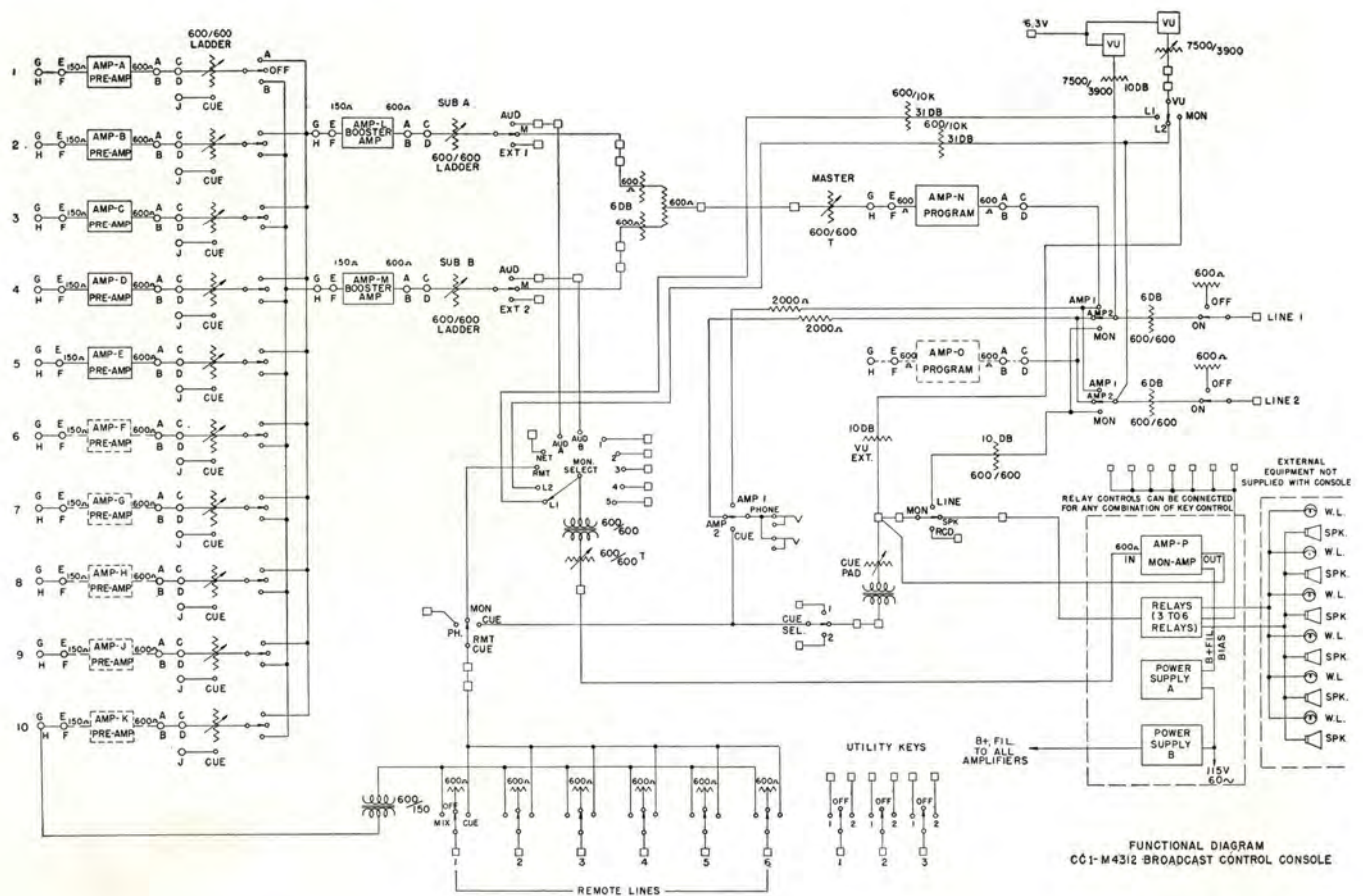

ACCESSORY UNITS FOR CC1 CONSOLE

4-CHANNEL MIXER

This unit has been designed to increase the number of mixing channels of the CC1 console from 10 to 14. Provision for four preamplifiers, either PRE1 or PRE4, listed on Page 128, may be procured as needed. Output impedance: 150 ohms. Input impedance to each of 4 channels: 600 ohms. Controls: 20 steps ladder with cue position at infinity, and identical to those on CC1 console. Mixing loss: 15 db. Size: 10 $\frac{7}{8}$ " wide, 11 $\frac{1}{16}$ " high and 21 $\frac{5}{8}$ " deep overall. Matches CC1 console in size and finish.

Four-channel mixing cabinet, less preamplifiers.
Cat. MX-1

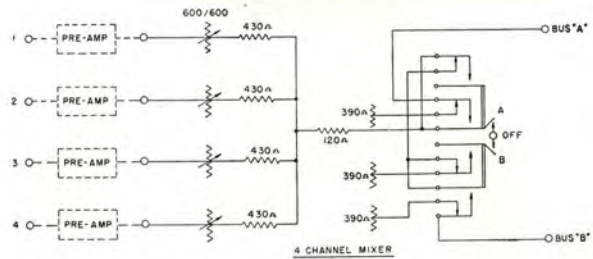

MONITOR SELECTOR

Single switching unit, as illustrated. Designed to accommodate 13 input circuits for general distribution of monitoring circuits. Has twelve push buttons, ten of which are for paralleling the output of each of the ten preamplifiers in the CC1 console. Two remaining P. B. switches parallel each program buss of the CC1. Lever key allows selection from program line to 12 push buttons. It is suggested that this unit be used with the monitoring amplifiers listed on Page 131. The input impedances are bridging at 10,000 ohms. Output: 600 ohms. Size: same as MX1 mixer listed above. Level control included.

Double switching unit. This is identical to the single unit except that it has double facilities, including dual level controls, 20 inputs plus 4 for program circuits off the main CC1 mixer buss, and dual selector keys between program circuit and push buttons.

Single switching unit.
Double switching unit.

Cat. SSW-1
Cat. DSW-1

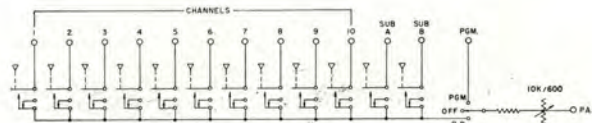

NOTE: 12 GANGED PUSHBUTTONS

MONITOR SELECTOR

ACCESSORY UNITS FOR CC1 CONSOLE



SOUND EFFECTS UNIT

Another excellent accessory to the CC1 console is this unique sound effects filtering equipment. Consists of one each FSE1 and FSE2 filters, fully described on Page 175. By means of the 12 push buttons and lever key, these filters may be inserted in any of the ten input channels of the CC1 console, either of the two main program busses or in the program line. Push button provides noiseless insertion. Size: 10 $\frac{7}{8}$ " wide, 11 $\frac{1}{16}$ " high and 21 $\frac{5}{8}$ " deep. Matches CC1 console in design and finish.

Sound effects unit.

Cat. CSE-2

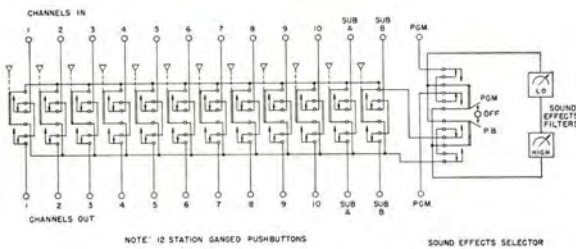

Above is the CB-6300 desk, designed to accommodate the CC1 console listed on Page 120. Beautifully styled, with top in rich maroon micarta, and will not stain. Sides and back are of steel, with wiring duct down the back. Finish: gray. Size: 39 $\frac{3}{4}$ " wide, 29 $\frac{1}{4}$ " high and 32" front to back.

Desk for CC1 console.

Cat. CB-6300



This illustration shows the CC1 console with a single accessory unit to the right. Any number of accessory units may be placed on each side. Louvers are inset and matching, providing through ventilation regardless of the number of accessory units added.



This is the PRD23 relay unit, which is standard equipment in the CC1 console for muting of loudspeakers and warning light control. Mounts as part of unit listed below. Note that relay power supply is part of the unit, and that relays do not depend on console power supplies; thus, eliminating complicated interlocking circuits.



The above PAS1 panel and shelf assembly with dual power supplies, monitoring amplifier, and relay unit mounted therein is supplied as standard with the CC1 console. Requires only 7"x19" of rack panel space. Design is such that it may be cabinet or wall mounted if rack cabinet is not part of control room facility.

Plug-In Amplifiers and Power Supplies

Audio equipment in modern radio and TV increasingly demands lower noise, lower distortion, better shielding and greater flexibility. In all of these the new Gates line of plug-in amplifiers, we confidently feel, is the finest audio equipment ever manufactured.

After a year of research, Gates engineers have developed not only electrically superb units of audio amplification but what we believe to be mechanically in advance of the times.

Plugs are self-aligning with their receptacles (see below) which means 100% interchangeability. — A panel and shelf assembly consumes only 7" of rack panel space, yet will hold eight preamplifiers or four of any other amplifier or power supply. Exactly 88 preamplifiers may be placed in a single 84" rack cabinet with complete ventilation and ease of rack wiring.

A new low in noise and distortion has been obtained. All specifications stated are typical and not laboratory models. — Selected tubes are definitely not a mandatory requisite for good performance. — Those designing new studios for radio or TV will want the finest and, indeed, the finest is offered on the following pages.

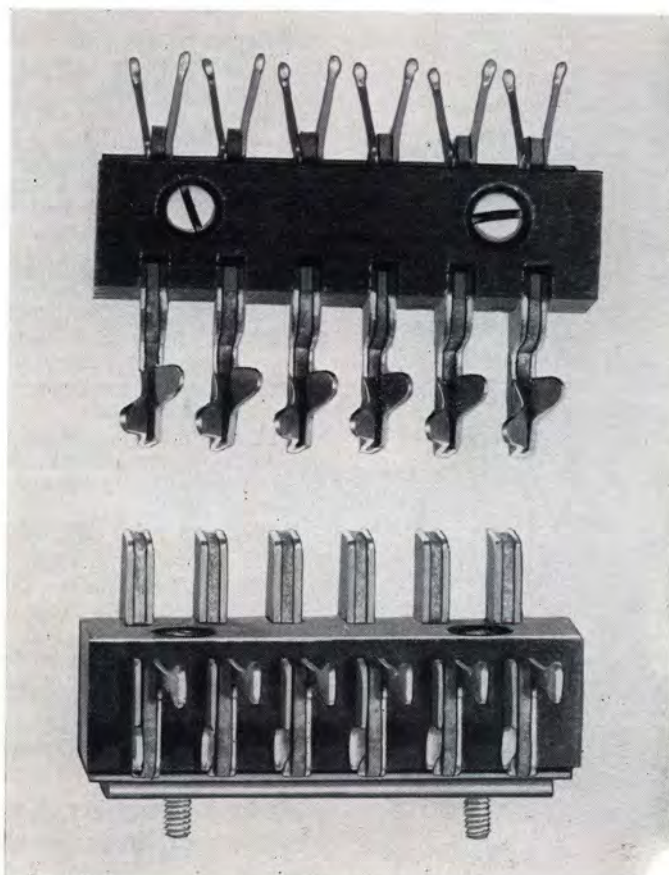

Plug-In Preamplifiers

TWO STAGE PREAMPLIFIER

Specifications

USE—As preamplifier or isolation amplifier where very low noise and distortion with flat response characteristics are demanded. When used as an isolation amplifier, the AT5 bridging control (Page 132) may be mounted on the front, if desired.

GAIN—As preamplifier, 40 db. As bridging isolation amplifier, 4 db.

DISTORTION—0.5% or less 50-15,000 cycles. 0.75% or less at 30 cycles. Measured at +8 dbm output.

NOISE—90 db below +10 dbm output (-120 to -124 dbm equivalent input noise).

LEVELS—Maximum input -32 dbm. Maximum output at above rated distortion, +8 dbm.

IMPEDANCES—Input 150 and 250 ohms. Output 150 and 600 ohms. As input transformer is unloaded, the impedance is substantially higher than source impedance over entire range.

POWER—6.3 volts AC at 3A and 300 volts DC at 6 Ma.

TUBES—two type 5879.

CIRCUIT—Two-stage shunt fed output. Overall feedback from plate of second stage to cathode of first stage.

MECHANICAL—Cold rolled steel chassis, die formed and plated. Size: 2 $\frac{1}{8}$ "x11 $\frac{1}{2}$ "x5 $\frac{3}{8}$ " high overall. Mounts eight in one PAS1 panel and shelf assembly. One PWR3 power supply will operate up to 26 preamplifiers; or, one PWR5 power supply will operate one preamplifier.

CC1 CONSOLE—Order this preamplifier in number required for CC1 console.

Plug-in preamplifier, less tubes.

Cat. PRE4

100% set of tubes for above.

Cat. TK112

Base with receptacle for above.

Cat. BA20

THREE STAGE PREAMPLIFIER

Specifications

USE—As preamplifier or isolation amplifier where extremely low noise, distortion and uniform response are demanded, as isolation amplifier is used with bridging controls—described Page 132.

GAIN—Matching 40 db. — Bridging 4 db.

RESPONSE— ± 1 db 30-15,000 cycles.

DISTORTION—0.5% or less 50-15,000 cycles, 0.75% or less at 30 cycles, all at +18 dbm.

NOISE—90 db or more below +10 dbm (-120 to -124 dbm equivalent input noise).

LEVELS—Maximum input -22 dbm. Maximum output +18 dbm.

IMPEDANCES—Source 50/150 ohms. Output 600/150 ohms. As input transformer is unloaded, the input impedance is substantially higher than source impedance over entire range.

POWER—6.3 volts AC, 0.45 amp., 300/330 volts 9.5 ma.

TUBES—Three type 5879.

CIRCUIT—Three stages, last stage cathode follower, overall feedback from third to first stage.

MECHANICAL—Cold rolled steel chassis die formed and plated. Metering switch on front for plate current all tubes. Size: 2 $\frac{1}{8}$ " wide, 11 $\frac{1}{2}$ " front to back, 5 $\frac{3}{8}$ " high. Receptacle and base plate supplied with each amplifier to accommodate plug. Mounts eight in a panel and shelf assembly. Operates one to sixteen from a PWR3 power supply.

Plug-in preamplifier, less tubes.

Cat. PRE1

100% set of tubes for above.

Cat. TK100

Base with receptacle for above.

Cat. BA20



TOP ENGINEERING POINTS

- 1—Distortion less than 0.75% 30-15,000 cycles.
- 2—Output level +8 dbm.
- 3—Extreme low noise.

How to Order

All plug-in amplifiers and power supplies should be ordered with the BA20 or BA21 base as listed on Page 128, except where ordered for the CC1 speech input console. Bases are supplied in the CC1 console. Example: for rack mounting, order amplifier or power supply, set of tubes and appropriate base, plus the PAS1 panel and shelf assembly—but where used in CC1 console, order amplifier and tubes only.



TOP ENGINEERING POINTS

- 1—Distortion less than 0.75% 30-15,000 cycles at full output.
- 2—Full output +18 dbm.
- 3—Noise 90 db below +10 dbm.

Plug-in Preamplifiers and Accessories

TWO-STAGE HI-IMPEDANCE INPUT

(with variable equalizer)

USE—As preamplifier where input transformer is not required, such as with transcription pickups or Hi-Z microphones. Supplied with two external controls and two fixed resistors. When used as straight preamplifier fixed resistors wired to terminal board. To provide variable equalization ± 20 db at 100 and 10,000 cycles, variable controls wired in, providing roll-off or accentuation as desired.

GAIN—40 db.

NOISE—Minus 70 dbm below plus 8 dbm output.

RESPONSE—Flat 30-15,000 cycles within +1 db as straight amplifier. ± 20 db at 100 and 10,000 cycles graduated when used with equalizing controls.

TUBES—Two type 5879.

IMPEDANCES—Input $\frac{1}{2}$ meg, output 150 and 600 ohms.

POWER—6.3 volts at 0.3A and 300 volts at 6 ma.

CIRCUIT—Two-stage shunt fed output with feedback from plate of second stage to cathode of first stage.

MECHANICAL—Same as PRE4 (Page 128).



TOP ENGINEERING POINTS

1. Variable equalization where desired.
2. Low noise and distortion.
3. Hi-Z input.

Plug-in preamplifier, less tubes.	Cat. PRE3
100% set of tubes for above.	Cat. TK112
Base with receptacle for above.	Cat. BA20

BASES FOR PLUG-IN EQUIPMENTS

Two standard bases accommodate all plug-in amplifiers and power supplies listed in these and subsequent pages. Type BA20 is for all preamplifiers and the PWR5 power supply. Type BA21 is for program and monitor amplifiers and all other power supplies. Attaches to PAS1 panel and shelf assembly as guide and termination receptacle for plug-in units. Die formed and heavily plated.

Base with receptacle for preamplifiers, etc. Cat. BA20

Base and receptacle for program, monitor and power units, etc. Cat. BA21



PANEL AND SHELF UNIT

The PAS1 panel and shelf assembly is designed to provide a rigid mounting for eight preamplifiers or four of any other unit or a mixture as requirements dictate. Page 3 illustrates several possible combinations.

All but the front panel is heavily plated so that slipping units in and out will not mar the finish. Top half of front panel is perforated to allow complete heat release. Panel fits firmly in place with pressure side snaps. Size: 19" wide, 7" high, 13 5/64" deep.

Panel and shelf assembly, standard gray.

Cat. PAS1

Same as above but in umber gray. Cat. PAS1A

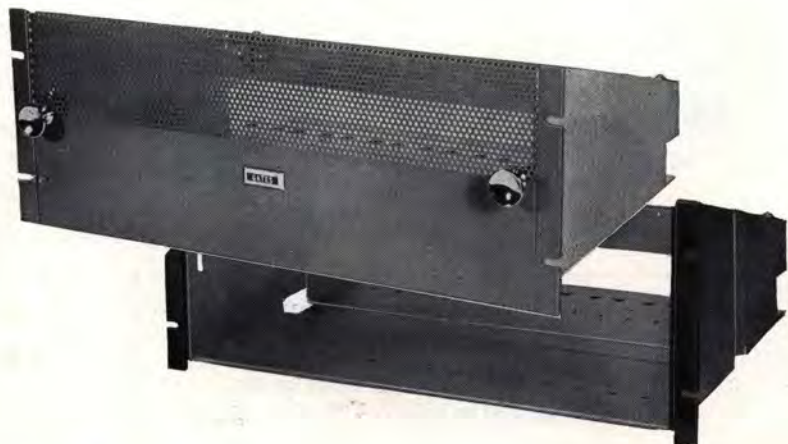

Plug-in Program Amplifiers

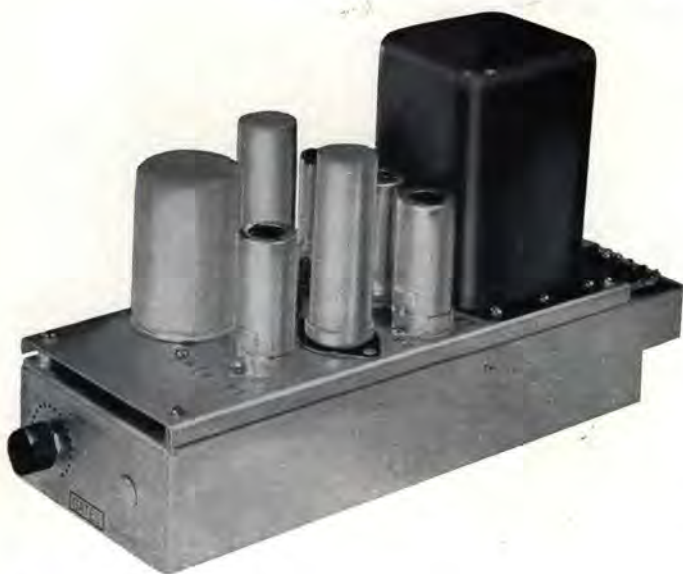

THE DIFFERENCE

As these two program amplifiers closely resemble each other, the difference is defined as the output level; and that the model PGM1 and PGM1A listed below have meter selector switch for direct reading of cathode currents.

MEDIUM OUTPUT PROGRAM AMPLIFIER

Specifications

- USE**—As a high quality program or line amplifier with a maximum output of +24 dbm. Used in Gates CC1 speech input console. The wide response, low noise and distortion assure acceptance of this amplifier in the most critical circuits.
- GAIN**—65 db as a line or program amplifier, direct matching of impedances. Where used as a bridging amplifier with AT2 bridging volume control, the gain is 33 db.
- RESPONSE**—±1 db 30-15,000 cycles.
- DISTORTION**—0.5% 50-15,000 cycles, 0.75% or less at 30 cycles.
- NOISE**—79 db or better below -24 dbm output with volume control fully open. (-120 to -124 equivalent input noise).
- LEVELS**—Maximum input +8 dbm. Maximum output +24 dbm.
- IMPEDANCES**—Input 150 and 600 ohms. Output 600, 150, 16, 8 and 4 ohms.
- POWER**—6.3 volts AC at 1.05A and 300/330 volts DC at 37 ma.
- TUBES**—Three 12AU7 and one 5879.
- CIRCUIT**—Three stages with push-pull output. Feedback between second and third stages.
- MECHANICAL**—Cold rolled steel chassis, die formed and heavily plated. Size: 4½" x 11½" x 6⅝" high overall. Type PWR3 power supply will operate from one to four of these program amplifiers.
- CC1 CONSOLE**—One of this type preamplifier supplied as standard in the CC1 speech input console. Where the second is desired, order this model.

Plug-in program amplifier, less tubes. Cat. PGM4
100% set of tubes for the above. Cat. TKI22
Base with receptacle for above. Cat. BA20



TOP ENGINEERING POINTS

1. Three stage push-pull output.
2. Distortion under 1% at +33 dbm output.
3. Noise 85 db or better below +30 dbm output.

HIGH OUTPUT PROGRAM AMPLIFIER

Specifications

- USE**—As program amplifier or any similar application.
- GAIN**—65 db ±1 db.
- GAIN CONTROL**—Model PGM1 supplied with carbon type gain control, PGM1A supplied with 20 step wiping contact control.
- RESPONSE**—±1 db 30-15,000 cycles.
- DISTORTION**—0.5% 30-15,000 cycles +25 dbm output or less than 1% at +33 dbm.
- NOISE**—85 db or better below +30 dbm output with gain control fully open. (-120 dbm equivalent input noise).
- LEVELS**—Maximum input +8 dbm. Maximum output at less than 1% distortion +33 dbm.
- IMPEDANCES**—Input 150 and 600 ohms. Output 600, 150, 16, 8 and 4 ohms.
- POWER**—6.3 volts AC, 1.35 amperes, 330/360 volts DC at 65 ma.
- TUBES**—Four 12AU7, one 5879.
- CIRCUIT**—Three stages single ended input and push-pull output. Feedback between second and third stages.
- MECHANICAL**—Cold rolled steel chassis die formed and plated. Meter switch and level control on front. Size: 4½" wide, 11½" front to back, 6⅝" high. Mounts four in a panel and shelf assembly. Receptacle and base plate supplied to accommodate plug. Operates one or two to a PWR3 power supply.

Plug-in program amplifier less tubes. Cat. PGM1
Plug-in program amplifier less tubes. Cat. PGM1A
100% set of tubes for above. Cat. TK101
Base with receptacle for above. Cat. BA21

Plug-in Monitoring Amplifiers

EIGHT-WATT MONITORING AMPLIFIER

Specifications

USE—For loudspeaker distribution, audition and certain types of recording.

GAIN—As straight amplifier, 103 db. When used with AT2 bridging control, 70 db.

RESPONSE— ± 2 db 30-15,000 cycles.

DISTORTION—3% or less at +39 dbm with gain control fully open. (Equivalent input noise -120 to -124 db).

LEVELS—Maximum input -27 dbm. Maximum output +39 dbm.

IMPEDANCES—Input 150 and 600 ohms. Output 600, 150, 16, 8 and 4 ohms.

POWER—6.3 volts AC at 1.5A and 320-340 volts DC at 85 ma.

TUBES—Two each 5879, 6AQ5 and one 12AU7.

CIRCUIT—Four-stage with push-pull output. Tertiary winding feedback from secondary of output transformer to cathode of driver stage.

MECHANICAL—Cold rolled steel chassis, die formed and heavily plated. Size: $4\frac{1}{8}$ "x $11\frac{1}{2}$ "x $6\frac{5}{8}$ " high overall. One PWR3 power supply, with one PWR10 bias supply, will operate one or two of these monitoring amplifiers.

Plug-in monitoring amplifier, less tubes. Cat. MON4

100% set of tubes for above. Cat. TK121

Base and receptacle for above. Cat. BA21



TOP ENGINEERING POINTS

1. Eight watts output.
2. High gain for universal usage.
3. One power supply operates two amplifiers.

HIGH OUTPUT MONITORING AMPLIFIER

Specifications

USE—Loudspeaker distribution, single or multiple.

GAIN—103 db ± 2 db matching. 70 db ± 2 db bridging and 10,000 ohm bridging control as on Page 132.

RESPONSE— ± 2 db 30-15,000 cycles.

DISTORTION—3% or less +40.8 dbm 50-7500 cycles.

NOISE—60 db or better below maximum output (-120 dbm equivalent input noise).

LEVELS—Maximum input -27 dbm. Maximum output 41.8 dbm (16 watts).

IMPEDANCES—Input 150 and 600 ohms. Output 600, 150, 16, 8 and 4 ohms.

POWER—6.3 volts AC, 2.4 amperes, 340-360 volts DC, 130 ma.

TUBES—Two each 5879, 6L6; and one 12AU7.

CIRCUIT—Four stage, last two stages push-pull. Tertiary winding—feedback from output transformer to cathode of driver stage.

MECHANICAL—Cold rolled steel chassis, die formed and plated. Meter switch and level control on front panel. Size: $4\frac{1}{8}$ " wide, $11\frac{1}{2}$ " front to back, $6\frac{5}{8}$ " high. Mounts four in a panel and shelf assembly. Operates one to a PWR3 power supply with PWR4 bias rectifier. Receptacle and base plate supplied to accommodate plug.

Plug-in monitor amplifier, less tubes. Cat. MON1

100% set of tubes for above. Cat. TK102

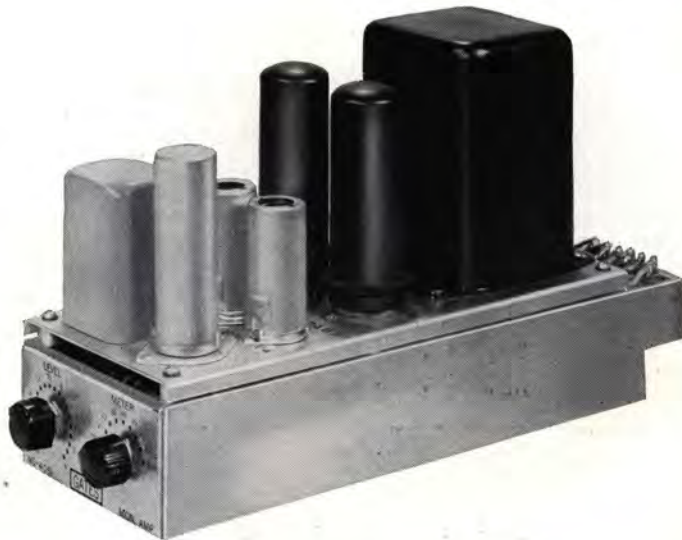

TOP ENGINEERING POINTS

1. Sixteen watts output.
2. High gain or bridging allows use from any low or high level circuit.
3. Wide variety output impedances.

Plug-in Power Supplies—Bridging Controls

HEAVY DUTY POWER SUPPLY

(with plug-in bias supply)

Specifications

USE—A regulated power supply of the electronic type using series regulator circuit to produce extremely low ripple content. Used with all amplifiers and where used with MON1 and MON4 monitor amplifiers, the PWR4 plug-in bias supply is also employed.

CAPACITY—Will supply up to sixteen PRE1, PRE3 or PRE4 preamplifiers, two PGM1 or four PGM4 program amplifiers, two MON4 or one MON1 monitoring amplifiers or any combination of the above.

POWER—Supplies 6.3 volts AC, 8 amperes, 310-350 volts DC at 0-160 ma. With PWR4 bias unit added, supplies 0-90 volts at low current. For 115 volts, 50/60 cycles. 230 volt design available on special order.

INTERNAL IMPEDANCE—Negligible.

INTERNAL REACTANCE—Negligible.

RIPPLE CONTENT—Less than 0.002 volts or 0.0006% through entire voltage range.

TUBES—One each 5V4G, 5879, 6080; and six NE51.

MECHANICAL—Cold rolled steel chassis, die formed and plated. Hum balance control on filament circuit and voltage output control on front. Size: 4 $\frac{1}{8}$ " wide, 11 $\frac{1}{2}$ " front to back, 6 $\frac{3}{8}$ " high. Mounts four in a panel and shelf assembly. Supplied with base plate and receptacle to accommodate plug.

Plug-in power supply, less tubes.

100% set of tubes for above.

Bias supply unit for PWR3 supply.

Base and receptacle for above.

Cat. PWR3

Cat. TK103

Cat. PWR4

Cat. BA21

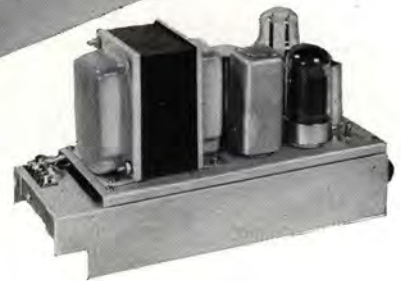
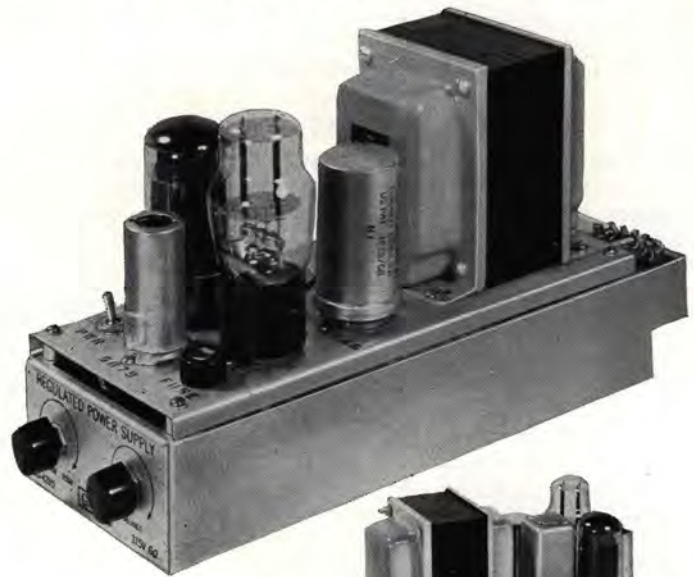

TOP—PWR3 Power Supply.

CENTER—PWR3 Power Supply with PWR4 Bias Supply plugged in.

LEFT—PWR4 Bias Supply.

PREAMPLIFIER POWER SUPPLY

This power supply has been designed to operate a single preamplifier, PRE1, PRE3 or PRE4. Usually used where preamplifier is isolated from main equipment such as in a transcription turntable. Mechanical size same as PRE1 preamplifier, listed Page 128. Supplies 6.3 volts AC at 0.9A and 300 volts DC at 10 ma. Ripple content 0.005% or less. A 6X4 rectifier into a well built LC filter is utilized.

Plug-in power supply, less tube.

Tube for above.

Base and receptacle for above.

Cat. PWR5

Cat. TK104

Cat. BA20



BRIDGING CONTROLS

For use with all Gates plug-in amplifiers where bridging instead of direct matching is desired. Where ordered for use with the PRE1 preamplifier a bracket is supplied for attaching to chassis. The AT5 bridging control is always used with the PRE1 preamplifier. All other amplifiers require external mounting of bridging controls. Two high quality carbon potentiometers in tandem balanced to ground are used in making up each control.

Control Input 10,000 ohms, Output 150 ohms.

Control Input 10,000 ohms, Output 600 ohms.

Control Input 20,000 ohms, Output 150 ohms.

Control Input 20,000 ohms, Output 600 ohms.

Control Input 10,000 ohms, Output 150 ohms.

Cat. AT1

Cat. AT2

Cat. AT3

Cat. AT4

Cat. AT5

Typical Plug-in Assemblies



— A —

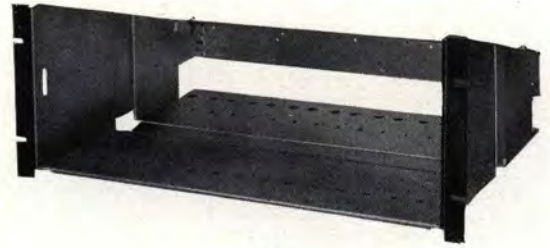

— B —

A— Front of Gates PAS1 panel and shelf assembly. Requires only 7 inches rack panel space. — Available in standard or umber grey. Front panel held in position by pressure snaps—instantly removable to release any amplifier.

B— Shelf assembly with panel removed. Entirely plated so that insertion or removal of amplifiers will not mar and will retain electrical ground at all times. Exact mechanical design prevents sagging in middle from amplifier weight.

C— Here are eight PRE1 plug-in preamplifiers consuming only 7"x19" rack space. Use of self-aligning plugs provides for complete interchangeability and no jamming of receptacle contacts.



— C —

D— Two amplifiers and two power supplies are shown utilizing only 7"x19" of rack space. Four program amplifiers, three power supplies and one monitoring amplifier now require 14"x19" of rack space—less than that required for one program amplifier only a short time ago.

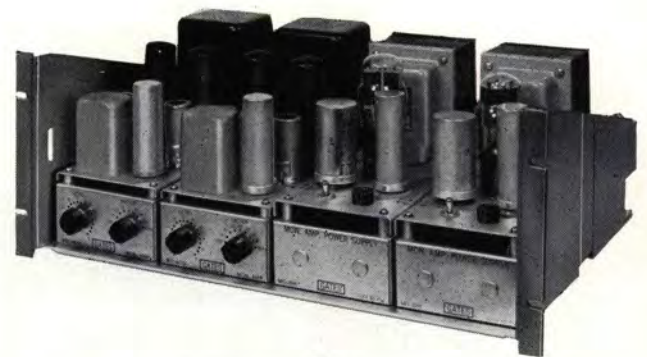

— D —

E— Two panels and shelves of 16 preamplifiers featuring rear view to indicate extreme simplicity of wiring. Cable harness clamps and trough are all part of panel and shelf assembly.

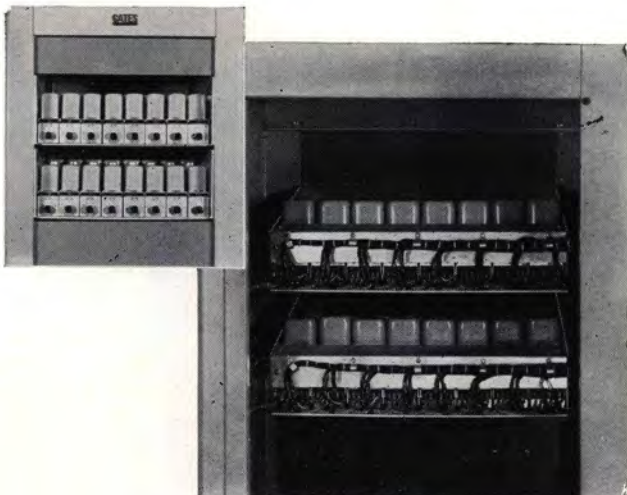

— E —

GATES SELF-ALIGNING PLUGS
MAKE PLUG-INS A PLEASURE

Dual Speech Input Console—Model SA-50

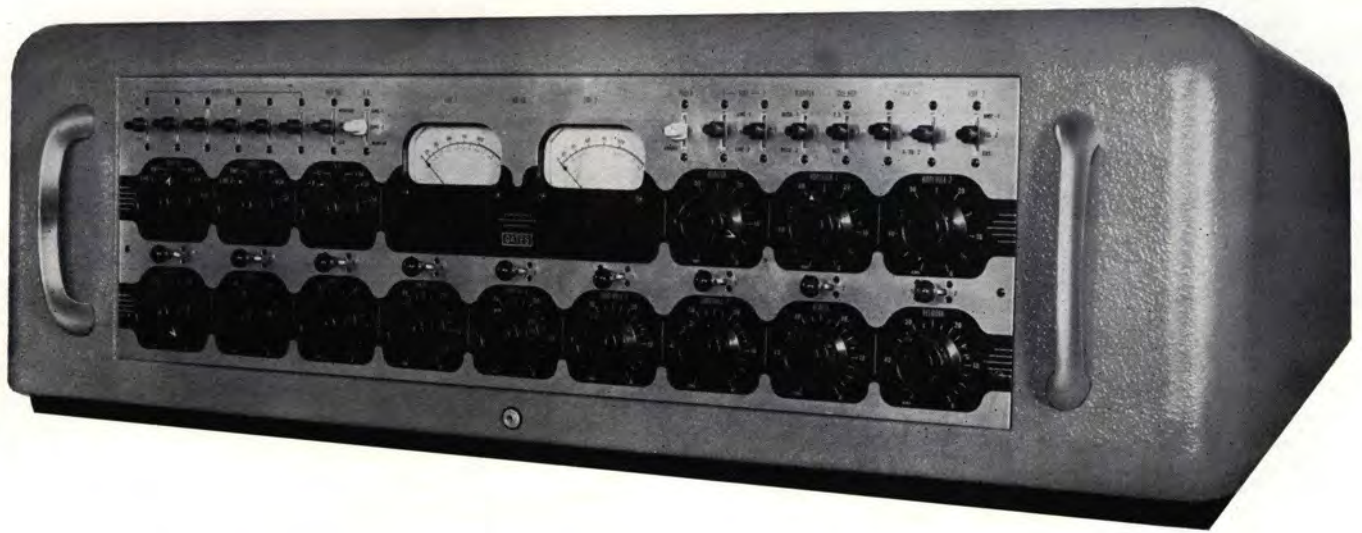

Gates speech input consoles have always been known as the “speech equipment with added features.” — In this distinctive instrument, the engineer will find nothing lacking. It is literally full of circuit combinations that cannot be performed on other consoles of similar size and price range. Commensurate with extensive facilities must be unquestionable quality of materials and workmanship. Quality and performance go hand in hand. Particularly is this true in audio equipment. The specifications stated on Page 137 are those of typical production equipments and not laboratory models. The Gates SA-50 console is in use in scores of radio and TV stations. — It is a time-proven product that will prove effective in either a modest or complex broadcasting station installation.

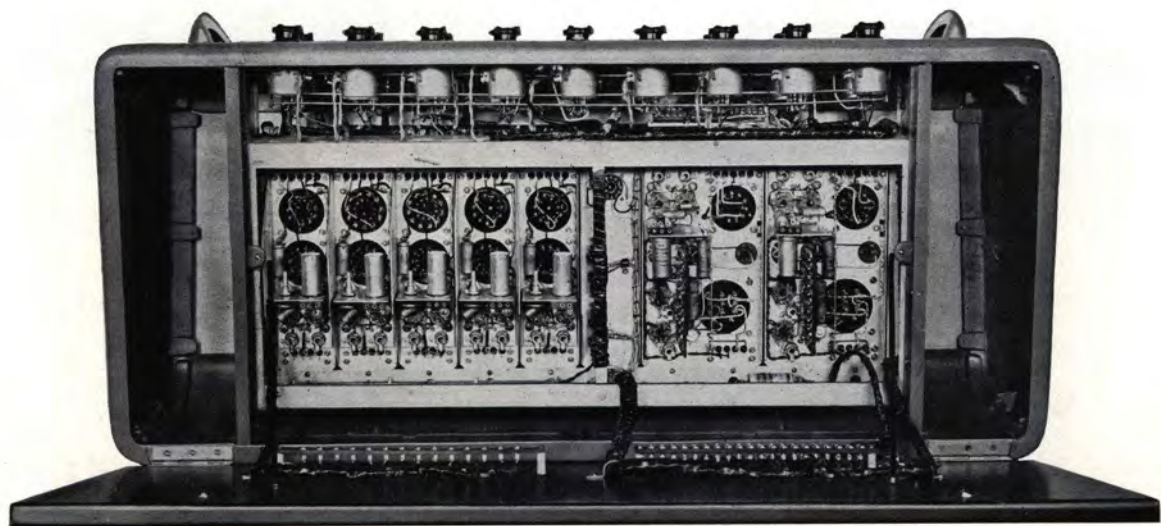

FLEXIBLE, COMPLETE, SERVICEABLE — MODEL SA-50

CABINET—Constructed of cast aluminum, tilt back type for servicing, with all terminations on base plate. Power supply constructed on cast aluminum SA housing (see page 136) with choice of wall or rack mounting. The SA-50 console is also available on the CB-60 desk shown on pages 136 and 163. Where this desk is used the cast aluminum cabinet is omitted and the console is constructed into a well in the desk itself which is covered by a hinged formed steel enclosure.

MIXING CHANNELS—Nine are provided with Daven ladder type controls throughout. Five are for microphones with associate preamplifiers, two are for turntables and one each for remote and network service. Each mixing channel has above it a PBX type key, allowing the selection of any mixing channel into the choice of the two identical program amplifiers. Turntable channels have cue provision.

AMPLIFIERS—Supplied as standard equipment are five two-stage preamplifiers, transformer coupled in and out with extreme shielding of the input transformer. There are two four-stage high gain program amplifiers, one three-stage ten-watt low distortion monitoring or audition amplifier and one two-watt cueing amplifier.

POWER SUPPLY—Provides all filament and plate voltage for the complete equipment along with voltage for operating the muting relays.

VU METERS—Duplicate 4" illuminated VU meters are supplied. The left VU meter operates across the program amplifier No. 1 at all times. The right VU meter is selectable across either of the two program amplifiers as well as the monitoring amplifier with adjustable range control.

REMOTE KEYS—Six provided with three operating positions: (a) Broadcast, (b) Override through the cueing amplifier, (c) Cueing of preceding program to remote.

CUE KEY—Connects selected remote line to input of the monitoring amplifier, order phone or cue.

POWER SWITCH—Provided so that emergency power supply Model SA-51 illustrated herein can be instantly switched into the circuit when desired. The SA-51 emergency power supply is not standard equipment.

LINE AMPLIFIER OUTPUT KEYS—Allows selection of output of either line amplifier to choice of either broadcast line or audition bus. A 6 db pad is always in the line circuit.

MONITOR AMPLIFIER OUTPUT KEYS—Selects output to three positions: (a) Normal, or speakers, (b)



Record I, (c) Record II. The record positions obviously may be used for any other service.

CUE AMPLIFIER KEYS—Selects cueing amplifier into three circuits: (a) Cueing of turntables, (b) Override of network, (c) Override for remotes.

TALK BACK KEYS—Selects the output of preamplifiers 4 and 5 to an external circuit where talk back is desired.

DUAL PROGRAMMING KEYS—Allows both program amplifiers to carry the same or separate programs. Also allows connecting the input of program amplifier 2 to an external pair of terminals for use with external mixer such as in master control.

MONITOR SELECTOR SWITCH—Selects the input of the monitoring amplifier to six positions: (a) Broadcasting line I, (b) Broadcasting line II, (c) Remote, (d) Network, (e) Air, (f) Audition.

PHONES SELECTOR SWITCH—Allows selection of headphone monitoring to (a) Line I, (b) Line II, (c) Remote, (d) Network, (e) Monitoring amplifier output, (f) Cueing amplifier output.

continued next page



MODEL SA-50 TWO-CHANNEL SPEECH INPUT SYSTEM

(continued from preceding page)

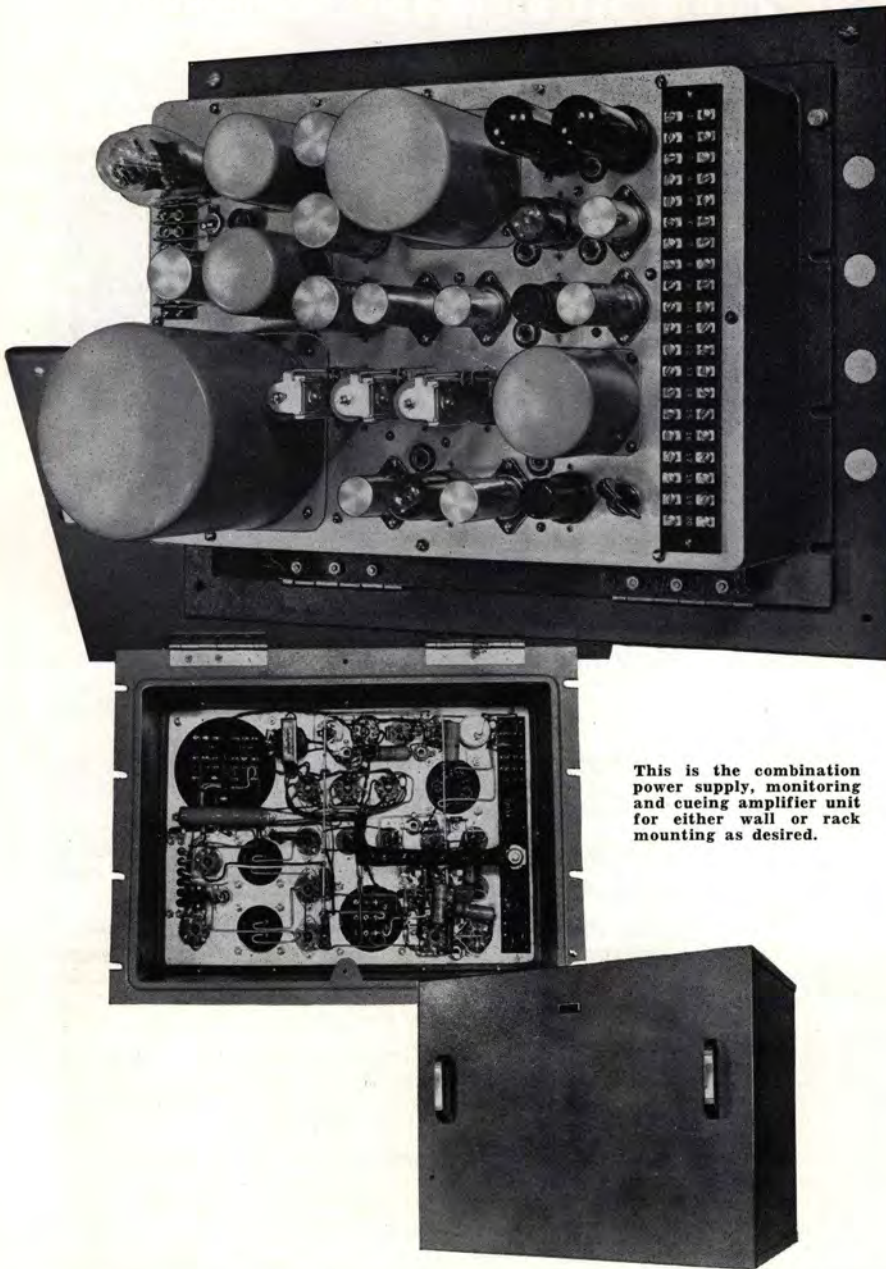

This is the combination power supply, monitoring and cueing amplifier unit for either wall or rack mounting as desired.

VU RANGE SWITCH—Provides six positions to +4 to +30 VU in conjunction with VU meter number 2.

GAIN CONTROLS—Individual master gain controls are provided for line amplifiers 1 and 2, being wiping contact types in the grid circuit and an additional gain control for the monitoring amplifier level.

SPEAKER MUTING RELAYS—Three provided, of the plug-in telephone type. Provides contacts for both speaker muting and operation of warning lights. Muting relays operate on the applied current principle, so that failure of voltage to muting relays will not place loudspeakers in a feedback condition.

GENERAL CONSTRUCTION — The unit construction plan is followed with all pre-amplifiers, program amplifiers and other sub-chassis units being individually removable for servicing without disrupting the operation of the balance of the console. The use of aluminum throughout, in the chassis, cabinet, and panel design, assures extremely low noise level and the elimination of varied chassis voltages. The front panel is an attractive anodized three color panel with the base color in natural anodized aluminum, the second color in rich black, and a third color in dark red. Cabinet is gray with base plate in black.

Model CB-60 Desk

(below)

Designed for the SA-40 and SA-50 consoles. Top, 5-ply with dull black linoleum covering, trimmed in brushed aluminum. Sides and back of steel, finished in gray. Console hinges back for servicing; and connecting cable between console and terminations on desk is supplied. Hinged console cover is part of desk assembly which takes place of cast console cabinet. Contour is for finger tip control and exact location of transcription turntables on each side. 29" high, 35" at greatest depth and 74½" at greatest width. Listed Page 137.

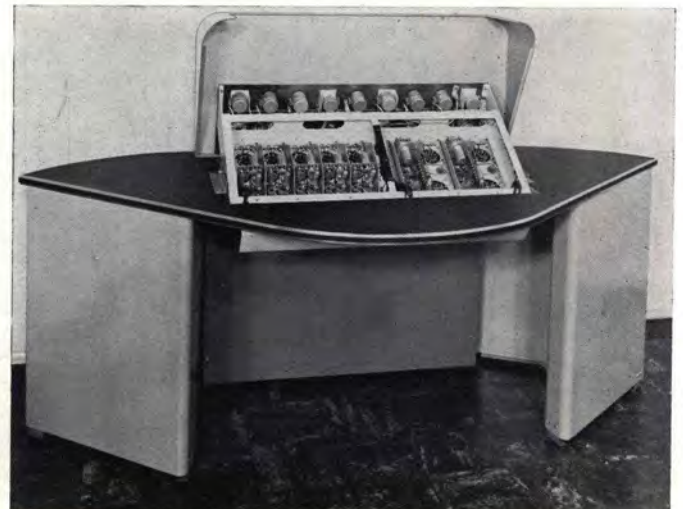
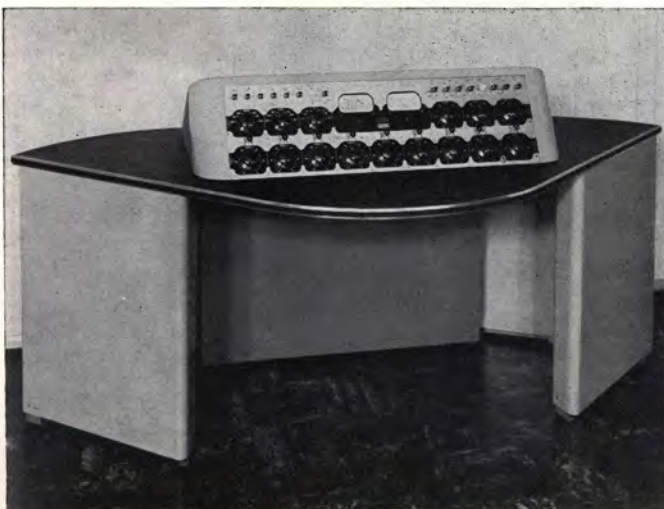

ORDERING DETAIL, FUNCTIONAL DIAGRAM — MODEL SA-50

SPECIFICATIONS

- PROGRAM AMPLIFIERS**—Two supplied, each four stages using one each 6J7, 6C5, 6SJ7 and 6SN7 tubes. Has 90 db shielding of input transformer. Test jacks provided for all cathodes.
- PREAMPLIFIERS**—Five supplied, with room in SA-50 cabinet for two additional preamplifiers where needed. Each preamplifier has two stages employing one each 6J7 and 6C5 tubes. Has gain control between first and second stage for use in circuit balancing where desired. Test jacks for all cathodes.
- MONITORING AMPLIFIER**—Has three stages employing one each 6SJ7, 6SN7 and two 6L6 tubes in push-pull. Full ten watts output at 2% distortion or less. Test jacks for all cathodes.
- CUEING AMPLIFIER**—A two-stage high gain amplifier using one each 6SJ7 and 6V6 tubes. Has bridging input and output impedance of six ohms. Test jacks for all cathodes.
- POWER SUPPLY**—Choice of wall or rack mount (specify when ordering). Included on same chassis, monitoring and cueing amplifiers, also muting relays. Uses 5U4G rectifier tube; power transformer maximum 40° C rise.
- MIXER**—Nine channels, ladder type controls having 2 db steps. Firm gripping skirt knob.
- KEYS**—Above each mixing control PBX type key with choice of key knob colors, such as red for Announce Microphone, black for Studio A, etc. Specify if any preference. Keys for remote and other miscellaneous circuits lever type with firm gripping silver plated contacts. Also choice of knob colors of the flat tabular type. See page 195 for knobs.

- GAIN**—From preamplifier input to either broadcast line, 105 db. From turntable or remote input to either broadcast line, 60 db. From network input to either broadcast line, 57 db. Monitoring amplifier, 60 db.
- NOISE**—At microphones: 60 DBM input to preamplifier noise is at least 60 db below +8 VU output.
- DISTORTION**—At output of either program amplifier, 0.8% or better at all frequencies. At output of monitoring amplifier, not exceeding 2% at 9 watts.
- RESPONSE**—From 30 to 15,000 cycles within 1½ db, except cueing amplifier which cannot be used in broadcast circuit.
- INPUT IMPEDANCES**—To all preamplifiers, 50, 200, 250 and 500 ohms. Turntables, 250 ohms, net and remote circuits, 500 and 600 ohms.
- OUTPUT IMPEDANCES**—500 and 600 ohms for each program amplifier and monitoring amplifier, and 6 ohms for cueing amplifier. Monitoring amplifier in conjunction with speaker muting relays is normally wired for four 2000 ohm speakers.
- TUBES**—Six each 6J7 and 6C5; three 6SJ7; two each 6SN7 and 6L6; one each 6V6 and 5U4G.
- SIZE**—Console 48" wide, 14½" high, 21" deep with 12° slope of front panel.
- POWER SUPPLY**—Wall Mount, 17¼" high, 22" wide, 12¼" deep. Rack Mount, 19" wide, 14" high, 11" deep.
- FINISH**—Medium gray aluminum, gloss anodized black and medium black with varied knob colors as desired.
- POWER CONSUMPTION**—300 watts from 115 volts 60 cycle line.

Ordering Detail

- Complete console, with tubes and rack mount power supply. **Cat. SA-50**
 100% set of tubes for above console. **Cat. TK-149**
 SA-50 console with CB-60 desk, connecting cable, tubes and rack mount power supply. **Cat. SA-5060**

Note: Wall mount power supply on special order and not normally carried in stock.

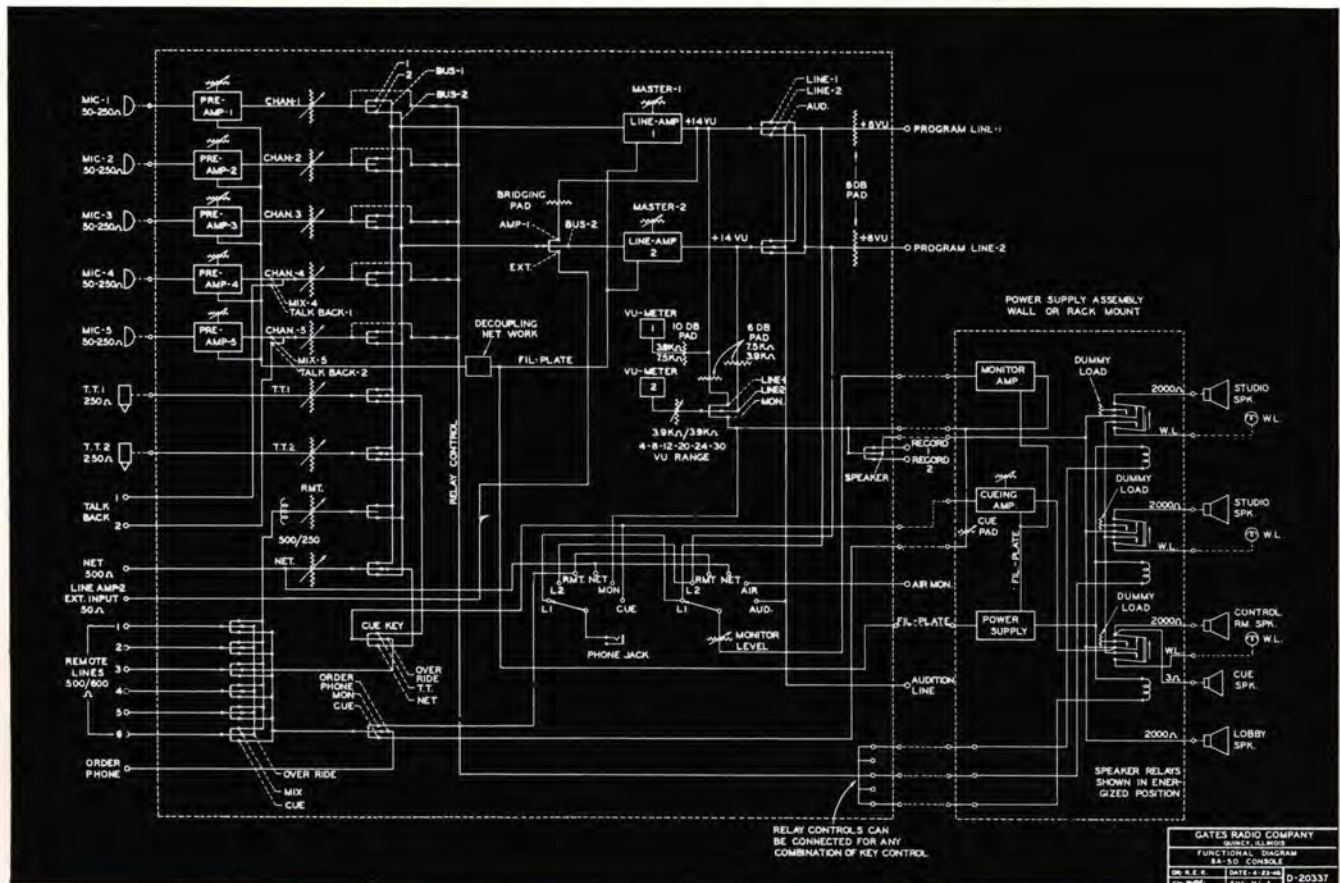

General Purpose Console—Model SA-40



Several hundred radio stations endorse the Gates SA-40 console as the finest in its class. For AM, FM, or TV, the wide facilities and modern design assure acceptance by the most discriminating engineer. — Nine mixing channels with three turntable or projector channels and a fourth channel for network, turntable or projector. Patch panel take-off provision adds greatly to the flexibility, but need only be used if deemed necessary. Massive and attractive appearance have not been overlooked. Serviceability, with tilt back cabinet, removable amplifiers and horizontal terminal strips, is indeed an outstanding high spot. — But most important of all is the outstanding technical performance. Low cross-talk, wide response, low noise and distortion, are all the result of built-in quality of materials and workmanship.



CONSOLES WITH DESKS

To the left is the Gates CB-63 desk, designed for the SA-40 and SA-50 consoles. Top 5-ply covered with dull black linoleum, trimmed in brushed aluminum. Sides and back of cold rolled steel finished to match console cabinet. Size: 50"x36"x30" high. Wiring duct down back of desk conceals wiring from floor to console. For listing, see Page 141.

By referring to Page 136 you will find the CB-60 desk, which may be used with the SA-40 console. Full description of this desk is on Page 136 and listing with SA-40 console on Page 141.

— NINE MIXING CHANNELS, WIDE RANGE OF FACILITIES

MIXER: There are nine channels, five for pre-amplifiers, three for transcription turntables and one for net-remote. Each turntable channel is provided with a cue attenuator whereby, when the attenuator is at off position, the turntable channel is connected directly to an external pair of terminals to which a cueing amplifier may be connected such as the SA-22, listed elsewhere in this catalog.

KEYS: Each mixing channel includes a PBX type key which enables a selection of each channel to either the program or monitoring amplifiers. The five microphone channel keys operate the three muting relays in any sequence desired.

REMOTE KEYS: Provision for six remote lines, three positions per key. (a) Broadcast, (b) Override, (c) Cue.

NET KEY: An extra key provided for network operation only, selecting either into the broadcast circuit or monitor-phones circuit.

OTHER KEYS: Are provided for selection of the VU meter across the remote, program or monitor

circuits: a **monitor key** selecting the monitoring amplifier input to any mixing channel, to the output of the program amplifier or to network or remote lines for override purposes; **line key** connecting program line direct to network so console may be turned off and broadcasting continue direct from transmitter; **monitor-out key** provides connecting monitoring amplifier output directly to terminals for recording, normal speaker circuit or through 10 db pad to program line for emergency purposes.

UTILITY KEYS: Are provided and wired directly to terminals, allowing the engineer to add any circuit combination he might desire.

AMPLIFIERS: Five two - stage transformer coupled preamplifiers, one four - stage line or program amplifier and one three-stage 10-watt monitoring amplifier are standard equipment. These are models SA-70, SA-94 and SA-95, listed elsewhere in this catalog (see index . . Amplifiers). Design is such that each amplifier may be quickly removed for servicing. Two more preamplifiers may be accommodated in each end of the SA-40 cabinet if needed.

(continued page 141)

Below, the SA-40 console on the popular CB-4 horseshoe desk with Gates CB-11 transcription turntables. This desk is fully described in this catalog (see index . . . Desks).

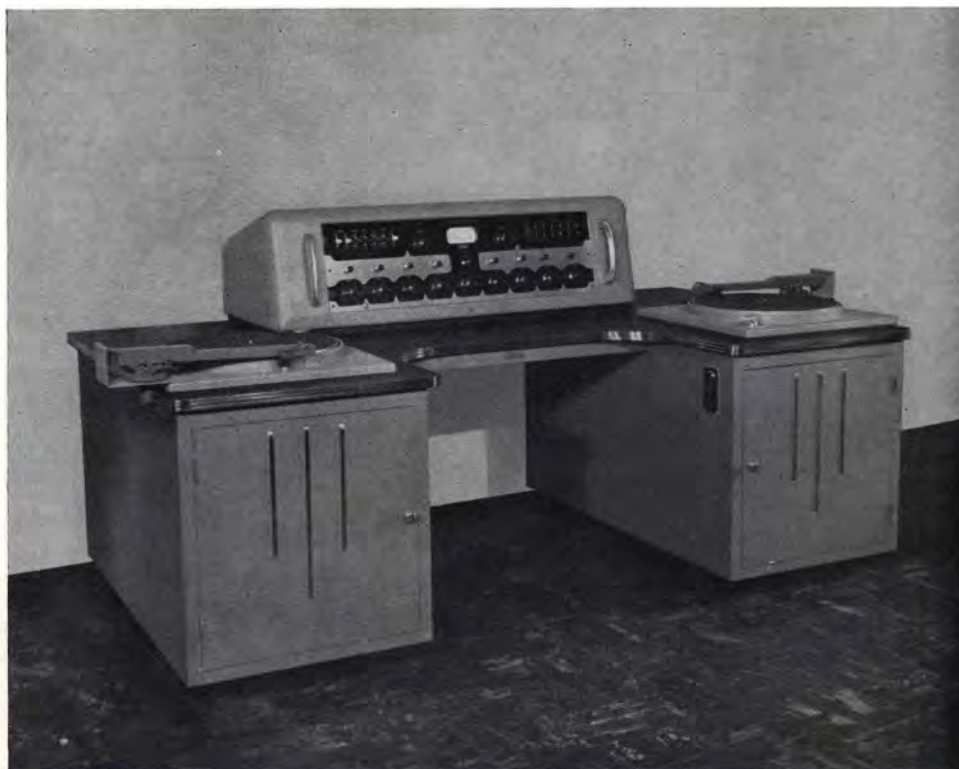

SA-40 CONSOLE — ILLUSTRATIONS — FUNCTIONAL DIAGRAM

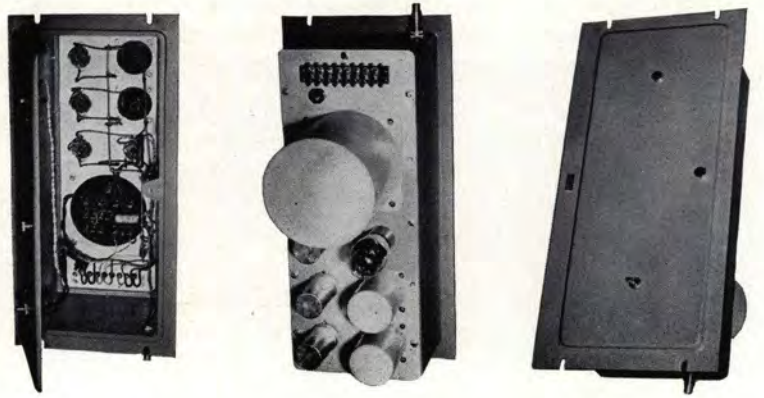

Above are front, internal and rear views of the rack mount power supply part of the SA-40 equipment.

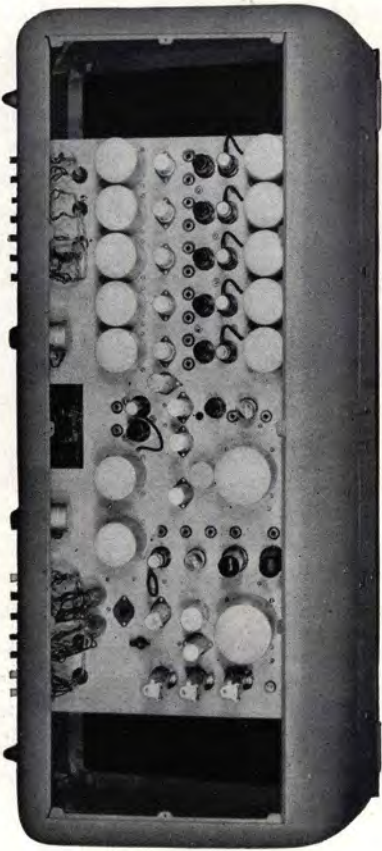

SA-40 console looking from top. All preamplifier tubes are shock mounted. Note heavy, sturdy construction of cabinet.

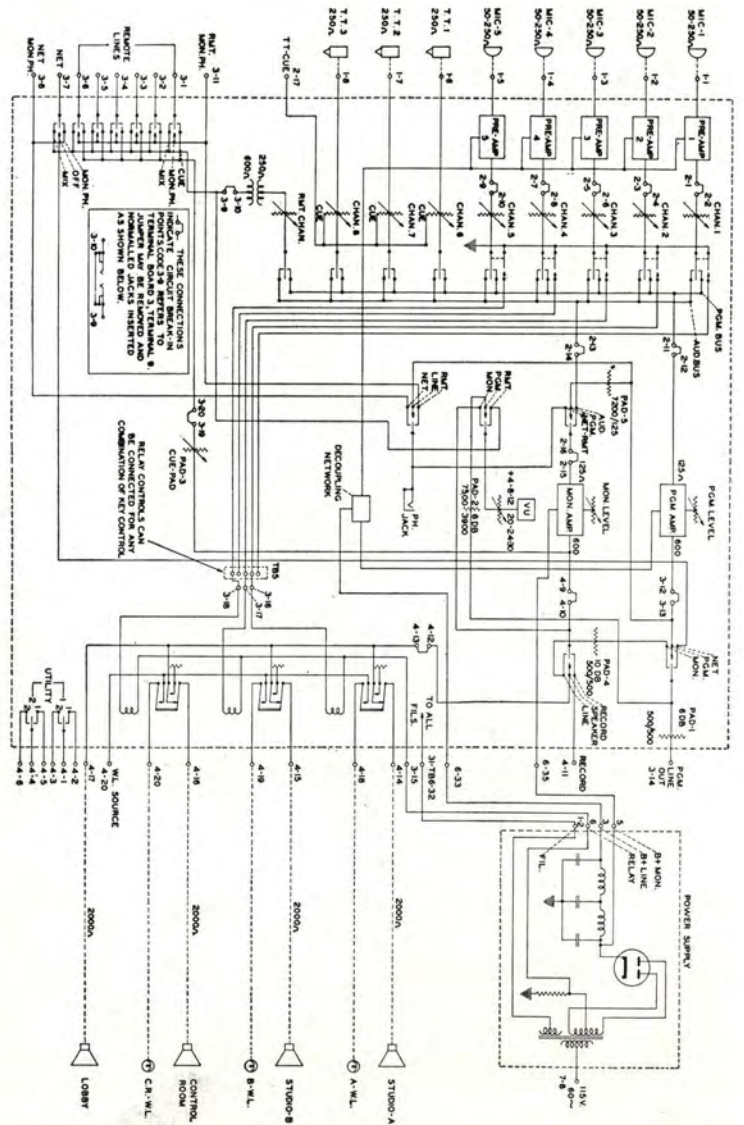

SA-40 Functional Block Diagram

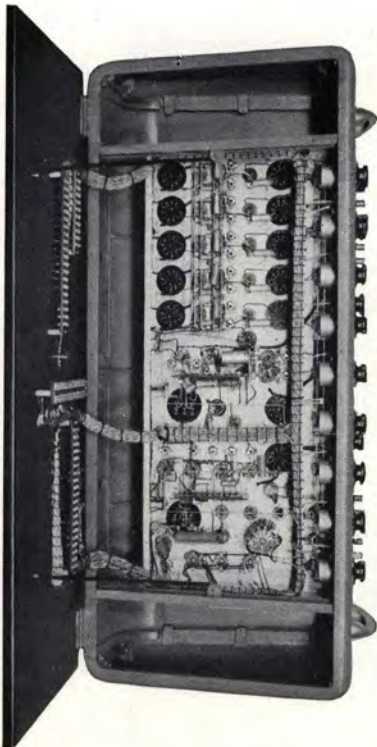

The tilt-back-to-service feature of the SA-40 console along with complete accessibility of all components and terminal connections is one of the outstanding features.

SPECIFICATIONS AND ORDERING DETAIL — MODEL SA-40

(from page 139)

CONSTRUCTION: The SA-40 console is constructed on a single-piece chassis. All input transformers have high shielding and no unorthodox circuits of any kind are employed. It should be particularly noted that all preamplifiers and other amplifiers are fully transformer coupled both input and output. By viewing the under-chassis design the unusual workmanship and generous use of shielded wire throughout will be noted. All tubes may be measured at their cathodes by jacks adjacent to each tube. The heavy cast aluminum tilt-back cabinet is standard equipment, while the power supply is constructed in the popular cast aluminum SA housing with front panel servicing.

PATCH PANEL TAKE-OFF: All major circuits such as preamplifier outputs, line and monitoring amplifier inputs, etc., are brought to terminal boards and bussed back into the normal console circuit. For greater flexibility an external patch

panel may be used in any of these circuits. Several types of patch panels are listed in this catalog (see index . . . Patch Panels).

TERMINATIONS: All terminations are to the base of the cabinet and immediately accessible. Care is taken to group input and output circuits to guide the installing engineer in external cabling, and to assure elimination of cross-talk or feedback. All terminals are numbered or lettered for easy identification.

VU METER: Large 4" illuminated scale B design.

MUTING RELAYS: Three are supplied, to mute loudspeakers and operate a break circuit for studio warning lights. These are so wired that relays will not activate loudspeaker circuits, causing feedback, in case of failure of the relay supply. Relays will operate from any of the five microphone channels and in any desired sequence by terminal arrangement and straps.

SPECIFICATIONS

AMPLIFIERS—Five two-stage preamplifiers with accommodation in cabinet for two additional model SA-70 preamplifiers (see page 151). Also one four-stage program amplifier and one three-stage 10 watt monitoring amplifier.

MIXING CHANNELS—Nine; ladder type controls, two decibels per step. Turntable attenuators have cue position.

GAIN—From preamplifier input to program line, 105 db.

From preamplifier input to monitoring amplifier output, 95 db.

From turntable, remote or net input to program line, 58 db.

From turntable, remote or net input to monitoring amplifier output, 68 db.

From turntable, remote or net input to program line when using monitoring amplifier and emergency pad, 38 db.

DISTORTION—Less than 1% from 50 to 15,000 cycles overall from microphone to program line. 2% from microphone to monitoring amplifier output.

NOISE—From preamplifier input measured at minus 60 dbm to program line measured at plus 8 dbm; 65 db below output level. All other circuit combinations equal or superior to above.

RESPONSE—Within 1.5 db 30-15,000 cycles.

INPUT IMPEDANCES—Preamplifiers, 50, 200, 250 and 500 ohms. Turntables, 250 ohms. Remote and net lines, 500 and 600 ohms.

TUBES—7 type 6J7, 6 type 6C5, 2 type 6SN7 and 6L6; 1 each 6SJ7 and 5U4G.

SIZE—40" wide, 14½" high, 21" deep.
Power supply: 19" wide, 8¾" high, 11" deep (rack mount).

FINISH—Medium gray with base trim in black, handles in brushed aluminum, panel anodized natural aluminum and gloss black with varied color key knobs.

CUE LEVEL CONTROL—Provided on chassis so that the amount of signal fed to remote lines may be adjusted.

Ordering Detail

Complete console with tubes and rack mount power supply. Cat. SA-40

100% set of tubes for above. Cat. TK-118

Desk as illustrated Page 128, less chair. Cat. CB-63

SA-40 console with tubes and power supply and with CB-60 desk as illustrated Page 136, includes joiner cable. Cat. SA-4060

Note: For cueing amplifiers, warning lights, microphones, speakers and other accessories, please refer to index for listing.

Gates Studioette—Model 52-CS

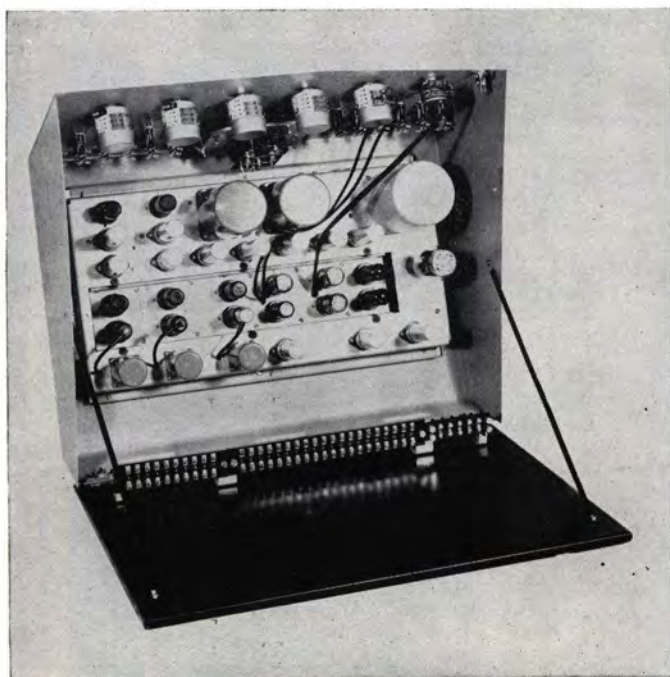
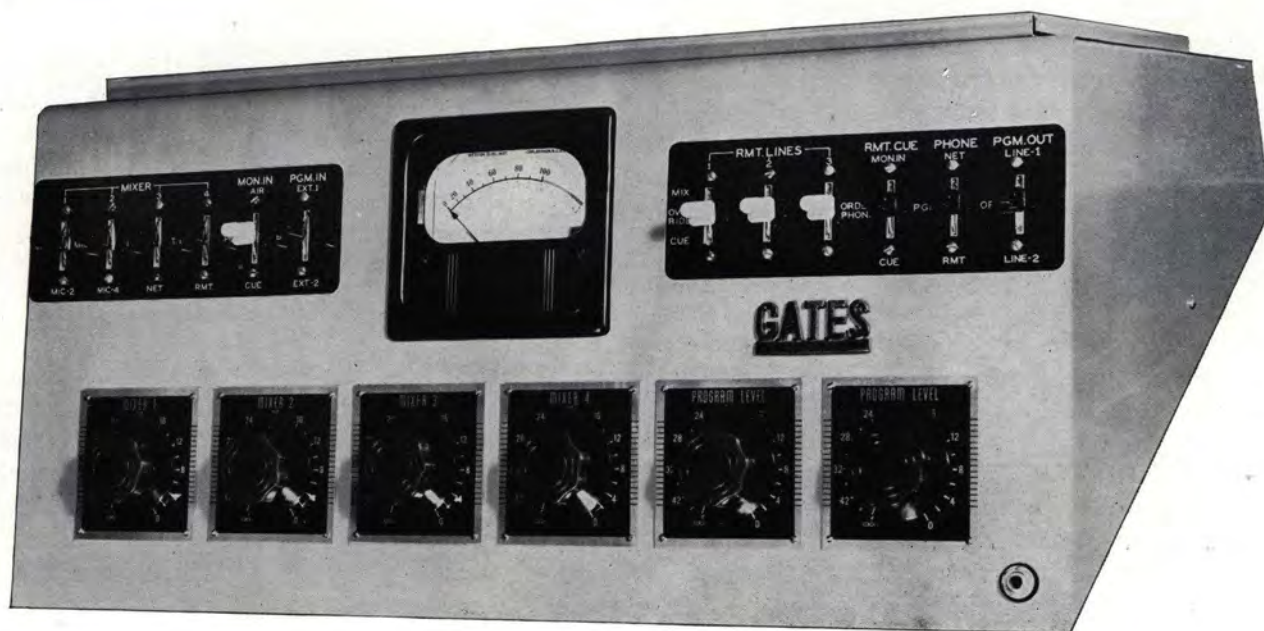

The above illustrates the tilt-back arrangement of the Studioette cabinet for reaching tubes, attenuators, and terminal connections instantly. For reaching under-chassis parts, the top of the cabinet is removable, making complete instantaneous 100% accessibility possible.

Many speech input installations require a console of modest size but with quality equal to that of larger equipments. — In the Gates 52-CS Studioette, the same quality of materials will be found as in the largest and most expensive speech input console described in this catalog. — The price is reasonable, because of the combination of more than one function through a single control, and the elimination of certain facilities found on larger equipments which are unnecessary on a unit such as this console.

Close observance of the specifications and functional diagram will disclose a surprisingly large number of facilities and circuit combinations. — The 52-CS Studioette is a very popular Gates item, and will be found in radio stations located in nearly every country on the face of the globe.

— FOR SMALL STUDIOS, TRANSMITTER CONTROL, RECORDING

(Model 52-CS)

GENERAL CONSTRUCTION: The Studioette is entirely self-contained. Basic design is around a 4-channel mixer, two preamplifiers, program amplifier, monitoring amplifier and power supply.

MIXER: Four channels with wiping contact ladder controls. Two channels operate from output of the two preamplifiers. The other two channels are combination turntable, remote and network channels by means of switching.

SWITCHING: Each preamplifier has an input switch, allowing selection of two input circuits for each amplifier, or four in all. These are usually for handling four microphones. Each of the two turntable channels serve a dual purpose. The first switches from turntable to network line, and the second from turntable to remote lines. — The monitor amplifier may be switched from aural to air monitoring. A switch is provided for switching the entire mixer output to a choice of two external program amplifiers. Switch provision for handling three remote lines with complete override and cue facilities is incorporated. Additional switches handle remote cue from the padded output of the monitoring amplifier, phone selection between network, program line and remote lines, and selection of the program amplifier output to a choice of two lines.

GAIN CONTROLS: Two supplied, for program and monitoring amplifiers.

VU METER: Standard 4", illuminated, scale B, VU meter is standard equipment.

AMPLIFIERS: Two (two-stage) preamplifiers, transformer coupled input, and cathode follower output, handle four microphone input circuits. Program amplifier has four stages, with an abundance of gain at low noise and distortion. Monitoring amplifier has three stages, 4 watts output, and serves the several functions of monitoring, cueing, loudspeaker distribution, etc.

RELAYS: Two muting relays may be wired in any sequence in conjunction with the preamplifier input switches to mute loudspeakers and supply a warning light switch break.

CUEING: Both turntable channels have cue switching at infinity position. These may be connected to any external amplifier for advance listing on network, remote lines and turntables. Remote lines also cue to the remote operator by facilities provided.

TERMINATIONS: Numbered and lettered terminal strip on base of cabinet is reached by tipping back cabinet.

Below, to the left, 52-CS studioette in mobile radio studio supplied to the United States Government.
Right, a typical studioette installation with tape recorders and turntables.



MODEL 52-CS SPEECH INPUT EQUIPMENT

SERVICING: This is most unique. Tip up the cabinet to change tubes, clean attenuators and reach terminal strips. Lift the lid to reach all wiring and clean relays. Not a single part is obscure.

MASTER CONTROL: Those interested in master control systems will note that the circuit design has been intended to lend itself to master control installations, as well as standard independent service.

POWER SUPPLY: The self-contained power supply provides all filament, plate and relay voltage for the entire equipment. Nothing external required.

SPECIFICATIONS

SIZE—24" wide, 21½" deep, 10" high. Panel slopes at 30 degree angle.

FINISH—Hand rubbed rose gray with escutcheons in anodized black and natural aluminum.

CONSTRUCTION—Cabinet 16 gauge cold rolled furniture steel with sub-chassis of aluminum.

TERMINATIONS—To numbered and lettered terminal strips, mounted on base of console.

GAIN—From microphone input to program line output, 105 db. From remote, network or turntable input to program line output, 60 db.

INPUT IMPEDANCE—Microphones, 50/250 ohms, network and remote 500/600 ohms, turntables 250 ohms; pro-program amplifier external input circuit 250 ohms.

NUMBER OF NETWORK LINES—1.

OUTPUT IMPEDANCE—Program line 500/600 ohms. Cueing circuit, 250 ohms. Monitoring amplifier, 500 ohms designed to operate into three 1500 ohm loudspeakers.

OUTPUT LEVEL—Program amplifier plus 8 dbm to line

(adjustable to higher or lower levels where required). Monitoring Amplifier, 4 watts.

NUMBER OF MICROPHONE INPUTS—4. (2 mixed at any one time)

NUMBER OF TURNTABLE INPUTS—2.

NUMBER OF REMOTE LINES—3.

RESPONSE—Plus or minus 1½ db, 30-15,000 cycles.

DISTORTION—Program circuit including preamplifiers, less than 1% from 50-15,000 cycles. Monitoring amplifier, 2% or less at 4 watts output, 50 to 15,000 cycles.

NOISE—Program circuit overall 65 db below plus 8 dbm.

TUBES USED—Three each 6J7 and 6SN7. Six each 6C5. Two each 6V6. One each 5U4G.

POWER LINE REQUIREMENTS—115 volts, 50-60 cycles, 125 watts.

METER—4" type, illuminated, Scale B.

RECOMMENDED USAGE—For all speech input requirements within its limitations for AM, FM and TV. Also recording of all types, high quality control unit for public address and centralized radio installations.

Ordering Detail

Studioette complete with tubes and ready to use.

Cat. 52-CS

Complete 100% set of tubes for above.

Cat. TK-106

Note: For desks, warning lights, microphones and loudspeakers for this equipment, see index.

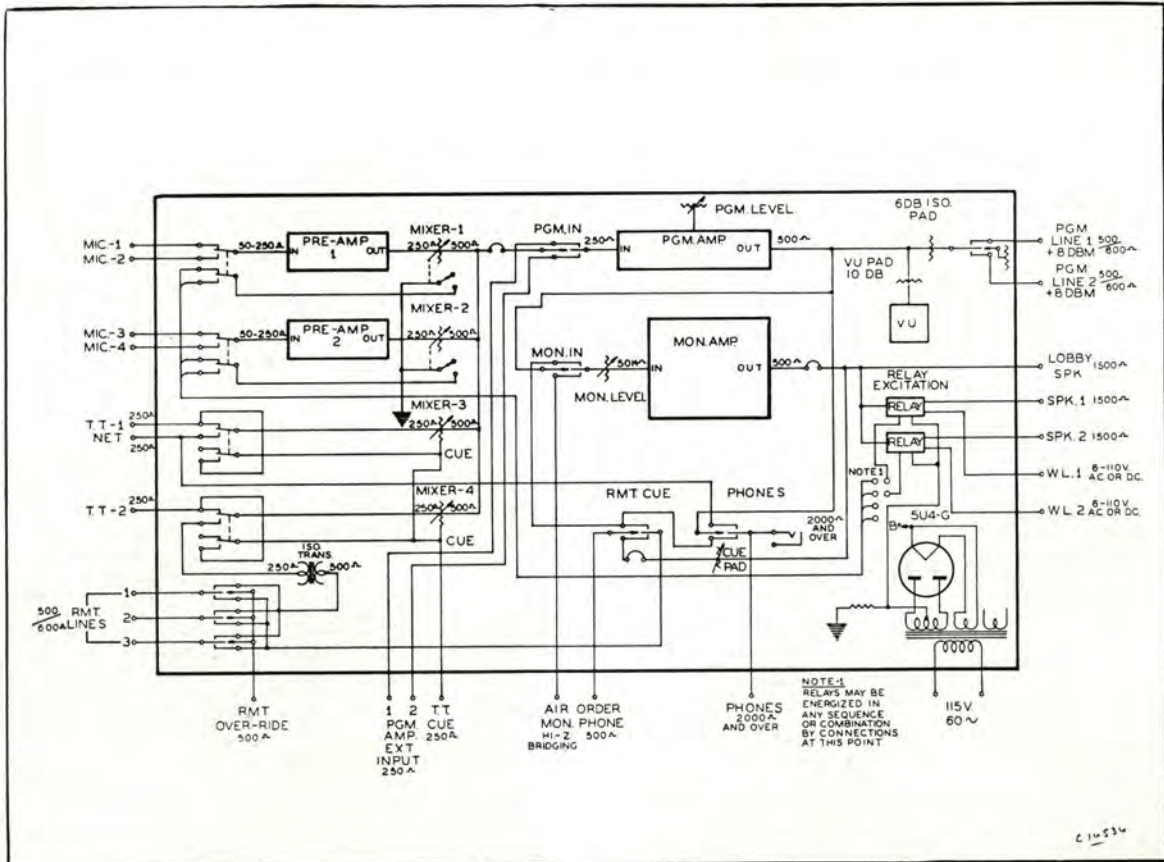

Block Diagram of 52-CS Studioette

Patch Panels and Cords



Fig. 1



Fig. 2



Fig. 3



Fig. 4

PATCH CORDS



The type E patch cords are provided in four different lengths, with a heavy double plug attached to each end. They will provide years of service without cord or plug breakage. Cords are shielded, and covered with a durable black braid reinforced six inches on each end. The plugs are accurately machined, to assure comfortable fitting and positive circuit make.

- Patch Cord, 2 ft. Cat. PJ12
- Patch Cord, 3 ft. Cat. PJ13
- Patch Cord, 4 ft. Cat. PJ14
- Patch Cord, 5 ft. Cat. PJ15

Illustrated to the left are industry-standard double patch jack assemblies with jack mats. Jack strips are listed separately; and when ordering, the proper jack mat is procured to fit the number of jack strips desired.

All jacks are of the closed circuit type, to allow normalling through of all audio circuits. Non-aging, non-ferrous, assuring permanent and proper tension. Contacts are of silver alloy. Jacks are held by molded bakelite reinforced with steel to prevent warping. Individual designation strips are supplied with slip-in holders for each pair of jacks.

Type C-150 is illustrated in Figure 3. This does not require a jack mat, as size is 19"x1 $\frac{3}{4}$ " for proper rack multiple. End brackets for rack mounting are supplied.

Type C-1500 jack strip is the double row strip, size 19" wide by 2 $\frac{1}{8}$ " high. This may be ordered without jack mat or with jack mats, as follows:

Fig. 1 illustrates type PD1 jack mat which accommodates a single C-1500 jack strip or 48 jacks (24 pairs).
Panel size: 3 $\frac{1}{2}$ "x19".

Fig. 2 illustrates type PD2 jack mat which accommodates two type C-1500 jack strips or 96 jacks (48 pairs).
Panel size: 5 $\frac{1}{4}$ "x19".

Fig. 4 illustrates type PD3 jack mat which accommodates three type C-1500 jack strips or 144 jacks (72 pairs).
Panel size: 7"x19".

Ordering Data

- | | |
|---|-------------|
| Single row jack strip, 24 jacks (12 pairs). | Cat. C-150 |
| Double row jack strip, 48 jacks (24 pairs). | Cat. C-1500 |
| Jack mat for one C-1500 jack strip. | Cat. PD1 |
| Jack mat for two C-1500 jack strips. | Cat. PD2 |
| Jack mat for three C-1500 jack strips. | Cat. PD3 |

Master Pre-set Control Equipment



Large studio installations, where there are many studios and several outgoing lines, are usually best suited to the master control type of installation. Listed on this and the next page are the M-4218 master pre-set equipment and the M-4219 local pre-set unit. These units are identical in appearance and similar electrically and mechanically. The above illustration contains one master pre-set unit (in center) and two local pre-set units. Underside illustration and single unit photo will be found below. — Any number of local or master units may be used. Because of unit construction, additions may be made any time. Master control, heretofore custom built, now may be a combination of standard units. Gates has always specialized in custom built speech equipments, and delights in working with those planning expanded facilities.

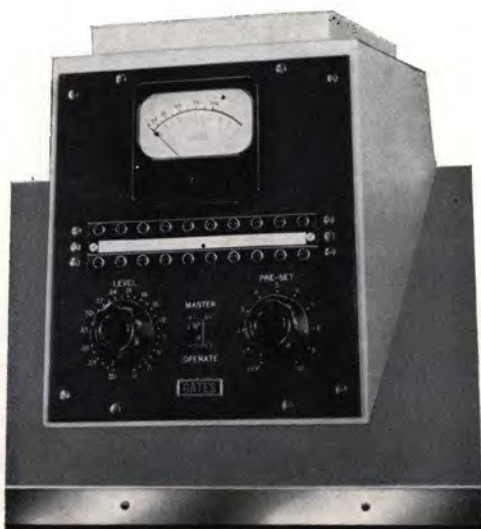

— FOR SIMPLIFIED HANDLING OF COMPREHENSIVE INSTALLATIONS

Basic design is around a parallel pre-set relay system. Ten relays in each unit are employed for program switching, and are pre-set from the front panel selector switch. These relays are, in turn, controlled by a master relay. A double bank of lights, red and green, indicate pre-set circuit (green) and on air circuit (red).

Lever key, located in the center, locks (up) to "Master" and is non-locking (down) to "Operate." Pre-set switch is then set to choice of any ten input channels. The green light indicates the channel pre-set. If it is desired to operate from the local position, press the lever key down momentarily to "Operate". The relays will then operate and the pre-set circuit will be energized.

This will then be indicated by the red "On Air" light. Where it is desired to turn the operation of the local unit over to the master unit, move the lever switch up to "Master".

The master unit operates identically in theory to the local unit, except that the master energizing switch is located adjacent to the VU meter (see center top unit, opposite page).

Included in each pre-set unit is a PGM1 plug-in program amplifier. This is for isolation and level boosting purposes. Level control on the front allows complete gain control of the operating circuit in conjunction with the 4" illuminated VU meter.

Specifications

- NUMBER OF CHANNELS—Ten.
- GAIN—28 db.
- RESPONSE— ± 1 db 30-15,000 cycles.
- NOISE—65 db or better below +8 dbm.
- INPUT IMPEDANCE—10,000 ohms bridging.
- OUTPUT IMPEDANCE—600 and 150 ohms.
- OUTPUT LEVEL—+8 dbm but may be increased to +24 dbm.
- In standard model, VU meter is set for +8 dbm unless otherwise stated when ordering.
- POWER—12 volts DC at 4A, 6.3 volts AC at 4.05A, and 300 volts DC at 200 ma. (Power supplies SA-102 and M-3229 are excellent). (see index . . . Power Supplies).

Local pre-set unit with tubes. **Cat. M-4219**
 Master pre-set unit with tubes. **Cat. M-4218**

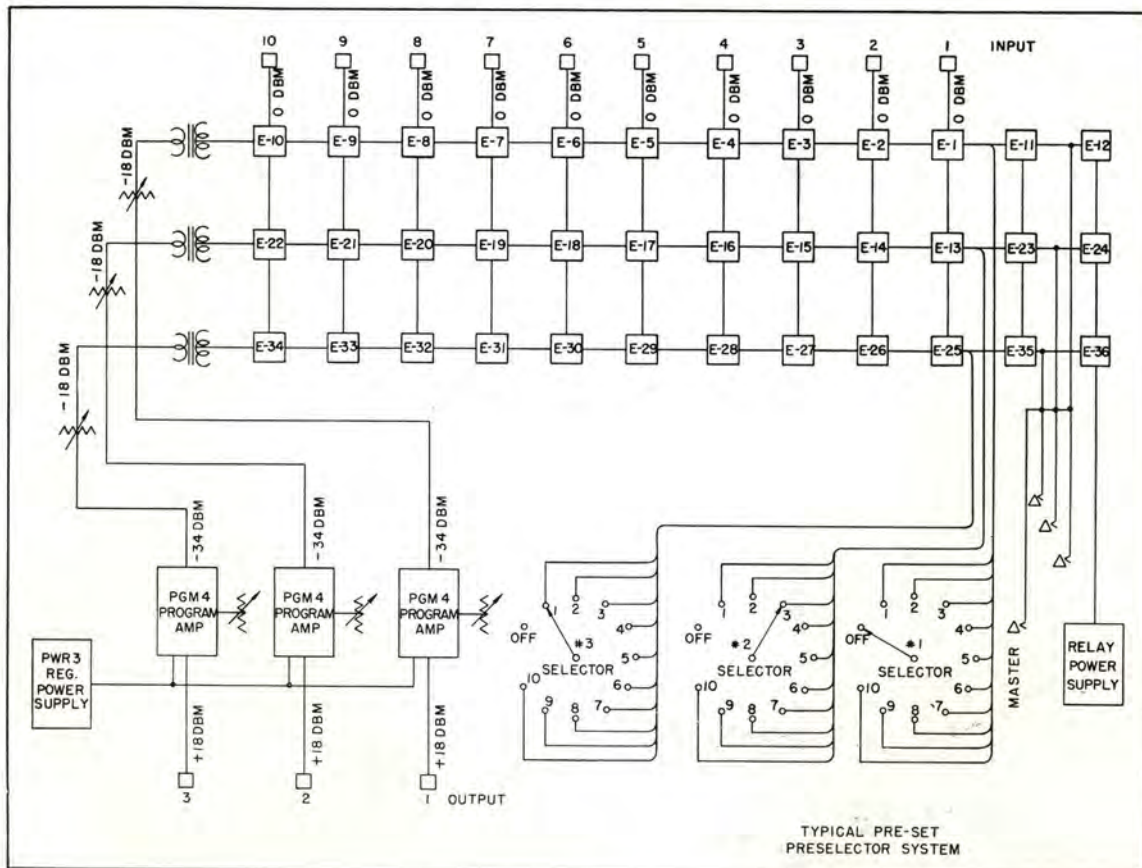

Peak Limiting Amplifier—Model SA-38



A Limiter with no thumps or chirps; yet, with instantaneous attack time.

The Gates SA-38 Limiting Amplifier has been designed to fulfill the exacting requirements of the modern broadcasting station, whether it be AM, FM, or TV. It is an extremely low distortion, low noise, fast acting limiter, completely void of thumps or chirps, at the attack time. Limiting action is obtained by feeding a portion of the output voltage through a full-wave rectifier and a negative DC voltage applied to the second control grid of the push-pull 1612 first stage amplifier tubes. As the output voltage increases, the grid becomes more negative, retarding flow of current, thus lowering the gain of the first stage. As a result, unusually high compression may be attained without increasing distortion, which is evidenced by the rated 1½% maximum distortion at as much as 20 decibels of compression. Three all push-pull stages are employed, which obtain their voltage from an accurately designed, regulated power supply. The limiter attack time can be considered instantaneous, while six varied release times between 0.2 and 1.2 seconds are available through a selector switch on the chassis. A large 4" dual scale meter provides reading of limitation in direct decibels of compression, and, by a switch on the front panel, provides a second scale reading directly in VU. There is provided a T network range control with two decibel steps from +4 to +42 VU which may be connected either across the output of the limiting amplifier, or to an external circuit, for other measuring purposes. Ladder type attenuators are provided at both the input and output circuits. The meter is a 4" illuminated unit. The exclusive Gates SA type housing is used for easy front-of-cabinet servicing. Jacks allow measurement of each tube cathode current.

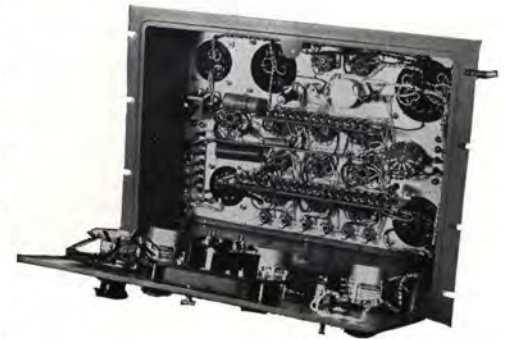

Specifications

INPUT IMPEDANCE—500/600 ohms.
OUTPUT IMPEDANCE—500/600 ohms.
INPUT LEVEL—From -20 VU to +20 VU.
OUTPUT LEVEL—+25 VU or less as adjusted by output attenuator.
MAXIMUM GAIN—60 db.
RESPONSE—30 to 15,000 cycles within 1½ db.
DISTORTION—1½% or less at all frequencies and up to 20 db of compression.
NOISE—70 db below any output level.
DIMENSIONS—19" wide, 14" high, 9½" deep.
FINISH—Medium gray.
POWER SUPPLY—Regulated to plus or minus 5 volts DC.
TUBES—Two each 1612, 6V6GT; three each 6SJ7; one each 6H6, 6S5GT, 6Y6G, 5V4G.
SHIPPING DETAIL—Net weight, 38 lbs.
Domestic packed, 74 lbs.
Export packed, 96 lbs.
Cubage, 12.

Limiting amplifier complete with tubes.

Cat. SA-38

100% set of tubes for SA-38 and SA-39 limiting amplifiers.

Cat. TK150

SA-39 Limiting—SA-22 Cueing Amplifiers

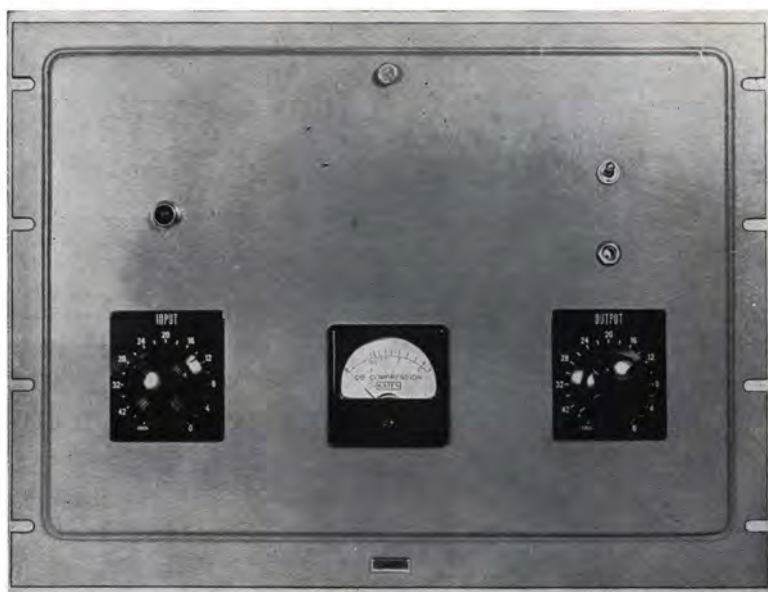

SA-39 Limiting Amplifier

This Limiting Amplifier is identical in every respect to the SA-38 equipment described on the preceding page, except that the combination compression and VU meter has been eliminated, and in its place has been provided a 3" meter reading directly in decibels of compression. The SA-39 Limiter is available to those stations already having adequate VU measuring equipment and not requiring that feature of the SA-38 equipment. In all other respects the SA-39 and the SA-38 are identical.

Limiting amplifier complete with tubes. Cat. SA-39

SA-22 Cueing Amplifier



Rear View SA-22

Complete independence in cueing of turntable, network, or remote circuits is desirable in each speech input installation. The SA-22 Cueing Amplifier is a compact, complete, self-contained rack mount equipment, including loudspeaker, providing a good level for cueing, and with proper tonal reproduction to provide carrying power over that of the full fidelity monitoring speaker used in the control room. A headphone jack is provided which, when the plug is inserted, disconnects the cueing speaker. A two-stage high gain amplifier with bridging input, having a gain of 50 db, is provided. The power supply is self-contained, and construction is in the popular Gates SA cast aluminum housing.

Specifications

TUBES USED—One each 6SJ7, 6V6, 6X5GT.
INPUT IMPEDANCE—50,000 ohms, bridging unbalanced.
SPEAKER—5" PM type.
INPUT LEVEL—Up to +10 VU.
OUTPUT WATTAGE—2 watts.
GAIN—50 db.
RESPONSE—Including speaker capabilities, 150 to 7000 cycles.
NOISE—50 db below +30 VU.
POWER REQUIREMENTS—50 watts from 115 V, 50/60 cycle line.
SIZE—19" wide, 8 $\frac{3}{4}$ " high, 9" deep.
FINISH—Medium gray.
SHIPPING DETAIL—Net weight, 17 lbs. Domestic packed, 34 lbs.
Export packed, 52 lbs. Cubage, 2.9.

Cueing amplifier complete with tubes. Cat. SA-22
100% set of tubes for SA-22 limiting amplifier. Cat. TK-151

SA SERIES PROGRAM AND MONITORING AMPLIFIERS



An excellent program or line amplifier constructed on the famous SA cast aluminum housing, with drop down front panel for under-chassis servicing. May be used in most exacting service where wide response, low noise and distortion are mandatory. Has three stages with power supply self-contained. Gain control, wiping contact type, in grid of first audio stage. Test jacks adjacent to each tube for cathode current measurements. Input transformer 90 db shielded. — The SA-20 has a wide variety of uses other than as a program amplifier. Because of this, it is ideal as an isolation amplifier, booster amplifier and all general purposes.

Program amplifier with tubes.
100% set of tubes for above.

SA-20 PROGRAM AMPLIFIER

Specifications

TUBES USED—One each 6J7, 6SJ7, 6SN7, 6X5.
INPUT IMPEDANCES—50, 250, 500, or 600 ohms, by input transformer taps.
OUTPUT IMPEDANCES—250, 500, or 600 ohms.
INPUT LEVEL—Minimum -40 VU for maximum output level.
OUTPUT LEVEL—At 1% distortion or less, +26 VU.
RESPONSE—30 to 15,000 cycles within 1½ db.
NOISE—70 db below +18 VU.
GAIN—60 db.
WATTAGE—50 watts from 115 volts 50/60 cycle power line.
COLOR—Medium gray (other colors on request).
SIZE—19" wide, 8¾" high, 9" deep.
SHIPPING DETAIL—Net weight, 21 lbs.
 Domestic weight, 40 lbs.
 Export weight, 89 lbs.
 Cubage, 7.1.

Cat. SA-20

Cat. TK107



Provides a full ten watts output at less than 1.5% distortion. Three stages with output stage push-pull. An input selector switch provides choice of bridging or direct matching input impedances. Gain control is in grid of first audio stage, and wiping contact design. Jacks are adjacent to each tube for cathode current measurements. Construction is on SA cast aluminum housing, with drop-down front panel to reach all under-chassis wiring.—Due to the low noise and wide response characteristics, the SA-10 amplifier may be used as a line or program amplifier by inserting a 20 db fixed pad in the output line. — As a monitoring, audition, loudspeaker distribution and recording amplifier, the SA-10 equipment is unexcelled.

Monitoring amplifier complete with tubes.
100% set of tubes for above.

SA-10 MONITORING AMPLIFIER

Specifications

TUBES USED—One each 6J5, 6SN7 (phase inverter), 5V4G. Two 6L6 (1622).
GAIN—70 db (500 ohms input) or 38 db bridging input.
FREQUENCY RESPONSE—±1.5 db, 30 to 15,000 cycles.
DISTORTION—1% or less at all frequencies from 50 to 15,000 cycles at levels up to +38 dbm, or 1½% up to 40 dbm.
NOISE—70 db or better below +38 dbm.
MAXIMUM INPUT LEVEL—0 db.
MAXIMUM OUTPUT LEVEL—+40 dbm.
INPUT IMPEDANCES—500, 250, 150, 50 and 20,000 ohm bridging.
OUTPUT IMPEDANCES—500, 250, 15, 7.5 and 5 ohms.
POWER REQUIREMENTS—125 watts from 115 volts 50/60 cycle line.
FINISH—Medium gray with dial plates in anodized aluminum.
SIZE—19" wide, 10½" high, 10¾" deep.
SHIPPING DETAIL—Net weight, 31 lbs.
 Domestic weight, 55 lbs.
 Export weight, 89 lbs.
 Cubage, 6.8.

Cat. SA-10

Cat. TK152

MICROPHONE AND TURNTABLE PREAMPLIFIERS

The SA-70 preamplifier is a high quality two-stage unit that may be mounted in the popular SA cast aluminum rack housing; or, as in Fig. B, in a simple chassis such as for turntables. Fig. C illustrates a single preamplifier for rack mounting. Fig. E shows five preamplifiers on an SA rack mount housing.—These preamplifiers are also standard equipment in the Gates SA-40 and SA-50 speech input consoles.

Both input and output transformers have multiple shields. The input transformer has 90 db shielding. Jacks are adjacent to each tube for cathode current measurements. Tubes are shock mounted. Terminations are to barrier design terminal strips. Power requirements are 6.3 volts AC at 0.6A and 180-250 volts DC at 3 ma. Chassis is of aluminum. Gain control is supplied to adjust to any level lower than maximum output.

Specifications

TUBES USED—One 6J7, one 6C5.

GAIN—42 db (adjustable).

RESPONSE— ± 1.5 db, 30-15 kc.

DISTORTION—1% 50-15 kc at -6 dbm.

NOISE—75 db below 0 dbm.

MAXIMUM INPUT—Minus 35 dbm.

MAXIMUM OUTPUT—Plus 4 dbm.

SIZE— $11\frac{3}{4}$ " long, 3" wide, $3\frac{1}{4}$ " above chassis,
 $3\frac{3}{8}$ " below chassis.

FINISH—Gloss gray.

SEE FIGURE A—Code ZAMYA.

Preamplifier with tubes, as in Fig. A.

Cat. SA-70

Preamplifier with base mounting chassis and tubes, as in Fig. B.

Cat. SA-71

Preamplifier for rack mounting, as in Fig. C.

Cat. SA-72

100% set of tubes for above.

Cat. TK105

TURNTABLE PREAMPLIFIER

(with power supply)



All Gates transcription turntables are equipped with the SA-134 three-stage preamplifier with self-contained power supply. The gain of 82 db is almost mandatory with many of the new lower level pickups. Being a complete amplifier - power supply, the SA-134 may be installed directly in the turntable cabinet or mounted on a $5\frac{1}{4}$ "x19" rack panel. — This amplifier is more fully described in the remote equipment section of this catalog.

Amplifier complete with tubes.

Cat. SA-134

100% set of tubes for above.

Cat. TK-107



Figure A—The SA-70 preamplifier. The gain control included allows any gain adjustment. Tubes are shock mounted.



Figure B—The SA-71 preamplifier in housing for turntable cabinet mounting or similar application. Mounting holes are provided in bottom of housing.



Figure C—The SA-72 preamplifier for rack mounting requires $3\frac{1}{2}$ inches of rack space.



Figure D—Back view of SA-72 rack mount preamplifier. Note the shock mounting of tubes, test jacks for plate current, metering and isolation of input and output terminations.



Figure E—Illustrates mounting five SA-70 preamplifiers on an SA-800 housing. This is the space saving and efficient way to mount Gates SA preamplifiers.

PROGRAM AND MONITORING AMPLIFIERS—SA SERIES

(for mounting in SA rack housings—Page 154)



SA-94 line amplifier illustrated above shows compact and highly efficient design of space line equipment. Technical specifications meet all requirements for AM, FM, or TV.

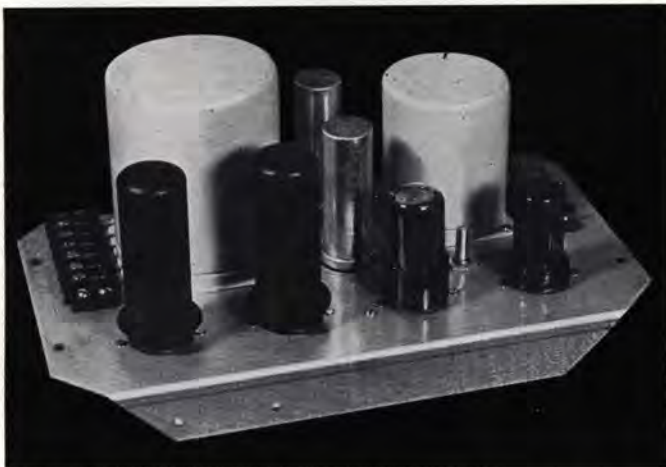

SA-95 ten-watt monitoring amplifier illustrated above is another companion unit to the many space line amplifiers in the Gates audio line.

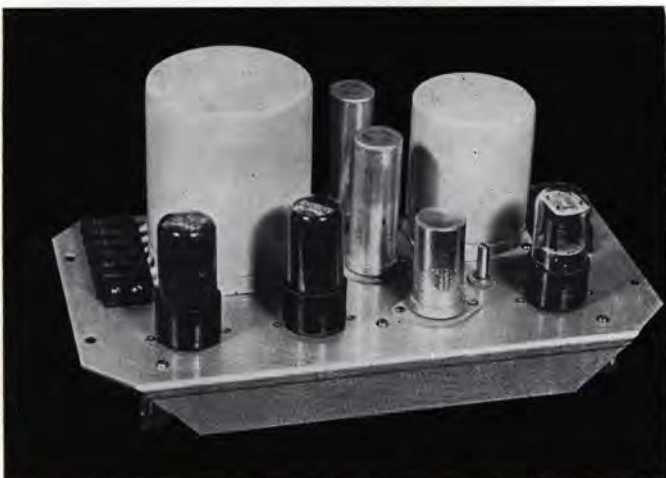

SA-96 two-watt monitoring amplifier illustrates another compact yet highly convenient way of obtaining the most from rack cabinet space. SA housings described on Page 154 are suggested.

PROGRAM AMPLIFIER

This program amplifier is standard in Gates consoles, SA-40 and SA-50. For rack mounting, the SA-800 housing as listed on Page 154 is used. Has four audio stages, providing abundance of gain to compensate for mixer insertion loss. Gain control is wiping contact type with 16" low capacity leads for attaching to front panel. Chassis of aluminum. May be used in any service where wide response, low noise and distortion are necessary.

Specifications

GAIN—82 db.
RESPONSE— $\pm 1\frac{1}{2}$ db 30-15,000 cycles.
DISTORTION—1% or less at +18 dbm.
NOISE—70 db below +18 dbm.
IMPEDANCES—Input 50, 150, 250 and 600 ohms.
Output 600 and 250 ohms.
POWER—6.3 volts AC at 1.5A and 300 volts DC at 25 ma.
(SA-99 power supply, opposite page, will operate from 1 to 3 of these amplifiers.)
SIZE— $11\frac{3}{4}$ " $\times 5\frac{1}{4}$ " $\times 4\frac{3}{4}$ " above chassis.

Program amplifier with tubes.
100% set of tubes for above.

Cat. SA-94
Cat. TK-108

TEN-WATT MONITORING AMPLIFIER

Delivers full 10 watts output at low distortion and wide response. Used in Gates SA-40 and SA-50 consoles. For rack mounting, use SA-800 housing as listed on Page 154. Has three stages with output stage push-pull. Gain control on chassis. For loudspeaker distribution, recording or auditioning, this amplifier is ideal. It may also be employed as a line amplifier by inserting a fixed pad in the output.

Specifications

GAIN—600 ohms input to output, 69 db. Bridging input to output, 42 db.
IMPEDANCES—Input 50, 150, 250 and 600 ohms. Also pad supplied for bridging input. Output 5, $7\frac{1}{2}$, 15, 250 and 600 ohms.
RESPONSE— $\pm 1\frac{1}{2}$ db 30-15,000 cycles.
DISTORTION— $1\frac{1}{2}$ % or less at +40 dbm (ten watts).
NOISE—65 db or better below +40 dbm.
POWER—6.3 volts AC at 2.7A and 350-400 volts DC at 130 ma. (SA-101 power supply, opposite page, recommended.)
SIZE— $11\frac{3}{4}$ " $\times 5\frac{1}{4}$ " $\times 4\frac{3}{4}$ " above chassis.

Monitoring amplifier with tubes.
100% set of tubes for above.

Cat. SA-95
Cat. TK-117

TWO-WATT MONITOR-CUEING AMPLIFIER

Modern high efficiency loudspeakers do not require high wattage. This two-watt amplifier has many purposes, such as supplying a Hi-Fi speaker, a cueing amplifier, or even as a standby program amplifier. Has two stages with output stage push-pull. Chassis of aluminum.

Specifications

GAIN—44 db from 600 ohms input to output or 15 db from bridging input.
IMPEDANCES—50, 150, 250 and 500 ohms. Also pad supplied for 10,000 ohm bridging input. Output 5, $7\frac{1}{2}$, 15, 250 and 600 ohms.
RESPONSE— $\pm 1\frac{1}{2}$ db 30-15,000 cycles.
DISTORTION— $1\frac{1}{2}$ % or less at +33 dbm output.
NOISE—65 db or better below +33 dbm output.
POWER—6.3 volts AC at 1.5A and 300 volts DC at 50 ma.
(Model SA-99, opposite page, will operate one or two of these amplifiers.)
SIZE— $11\frac{3}{4}$ " $\times 5\frac{1}{4}$ " $\times 4\frac{3}{4}$ " above chassis.

Monitoring amplifier with tubes.
100% set of tubes for above.

Cat. SA-96
Cat. TK-153

POWER SUPPLIES — SA SERIES

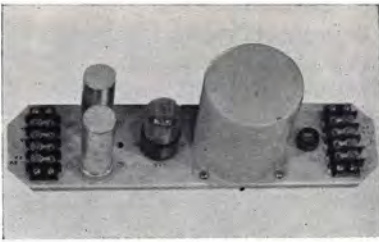

SA-77 Power Supply

Supplies filament and plate voltage to two SA-70 preamplifiers. Provides 6.3 volts AC at 2A and 250 volts DC at 10 ma. Rectifier 6X5GT. Size: 11 3/4" x 3" x 3 3/4" above chassis. Mounts on SA-800 housing (opposite page) or on SA-78 or SA-79 chassis and panel (see below).

Power supply with rectifier tube.

Cat. SA-77

Tube kit for above.

Cat. TK-133



SA-99 Power Supply

Provides 6.3 volts AC at 5A and 325 volts DC at 120 ma. Mounts on SA housing (opposite page). Dual reactors and high capacity assure low noise. Size: 11 3/4" x 5 1/4" x 4 1/2" above chassis. Rectifier tube 6X5GT.

Power supply with rectifier tube.

Cat. SA-99

Tube kit for above.

Cat. TK-133



SA-101 Power Supply

A heavy duty power supply to handle the SA-95 monitoring amplifier or several other amplifiers. Provides 6.3 volts AC at 8A and 400 volts DC at 200 ma. Size: 11 3/4" x 5 1/4" x 5 1/2" above chassis. Rectifier 5U4G. Mounts on SA-800 housing (opposite page).

Power supply with rectifier tube.

Cat. SA-101

Tube kit for above.

Cat. TK-134

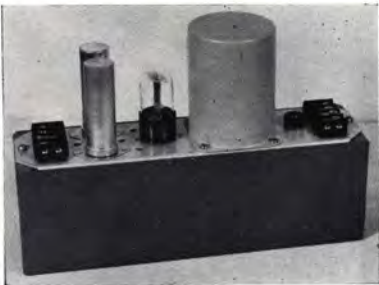

SA-78 Power Supply

The SA-77 power supply, described above, is mounted in a chassis to allow base mounting such as in a turntable cabinet or for individual use. Size: 11 3/4" x 3" x 7 3/4" high.

Power supply with rectifier tube.

Cat. SA-78

Tube kit for above.

Cat. TK-133



SA-79 Power Supply

This combines the SA-77 and SA-78 which mounts on a 3 1/2" x 19" rack panel for the rack mount of a single preamplifier. Size: 19" x 3 1/2" x 8" deep.

Power supply with rectifier tube.

Cat. SA-79

Tube kit for above.

Cat. TK-133



M-3229 Power Supply

A rack mount, heavy duty power supply. Standard with SA-40 console, also used with M-4218 and M-4219 master pre-set units. Type SA-500 rack housing is used (see dimensions, opposite page). Provides 6.3 volts AC at 8A and 350-400 volts DC at 200 ma. A very well filtered supply that may be used for any service. 5U4G rectifier.

Power supply with rectifier tube.

Cat. M-3229

Tube kit for above.

Cat. TK-134



SA-7 Power Supply

Designed to operate up to ten SA-70 preamplifiers. Delivers 6.3 volts AC at 6.5A and 180-300 volts DC at 75 ma. DC is adjustable by voltage divider. Built on SA-400 rack housing (see opposite page for dimensions). 5V4G rectifier tube.

Power supply with rectifier tube. Cat. SA-7

Tube kit for above.

Cat. TK-154



SA-102 DC Power Supply

Designed to supply 6-12 volts DC at 6A. Used with M-4218 and M-4219 master pre-set units but, of course, excellent for any service where 6 to 12 volts DC is required. Built on SA-500 rack housing (see opposite page for dimensions). Ratings are continuous at 6 volts and ICCS at 12 volts such as for relays. Uses selenium rectifiers.

Power supply complete.

Cat. SA-102



All Power Supplies

The power supplies on this page are all designed for 115 volts, 50/60 cycles.

OTHER POWER SUPPLIES

Plug-in power supplies will be found listed on Page 132.

CAST ALUMINUM SA SERIES RACK MOUNT HOUSINGS

(for rack mounting of SA amplifiers)



Above, the SA rack mount housing front view with drop-down door closed. Entire construction is of cast aluminum.

The SA housing for the rack mounting of speech input equipment is an exclusive Gates design, the outstanding feature being the 100% cast aluminum construction, including the drop-down front panel which has the hinges as part of the main body casting. Though the SA housing has been principally designed to accommodate the many models of Gates SA amplifiers, it obviously can be used for practically any application where standard rack panel equipment is required. The SA housing consists of two pieces::

- (a) The main body, which is the rack panel itself. Extending six inches from the back of this panel, as part of the one-piece casting, is a $\frac{5}{8}$ " thick cast aluminum wall which holds rigidly the heaviest chassis.
- (b) The drop-down front door is so hinged that the door may become a shelf on which tools or test instruments may be laid without danger of breakage, while the under-chassis components are serviced from the front of the rack cabinet. It should be particularly noted that the drop-down door is so designed that on any type of rack cabinet **there is no need to remove the style strips**, where existing, before the door can be lowered.

The design of the SA housing in cast aluminum offers particular advantages in audio circuits, where noise level is much reduced over that of steel. Each housing is attractively finished in medium gray, though other colors are available on special order with minimum delay. At the bottom of this page are dimensional drawings for the various sizes of SA housings available from stock.



To service equipment mounted on SA housings, drop down the rigid cast front door. Note how every under-chassis component can be reached. Cabinet style strips need not be removed to drop down front door.

Ordering Information

Complete housing. Cat. SA400
 Complete housing. Cat. SA500
 Complete housing. Cat. SA600

Complete housing. Cat. SA700
 Complete housing. Cat. SA800

(See bottom of page for sizes)



Here is how five Gates SA-70 or SA-74 preamplifiers are mounted on one SA-800 housing, providing more compactness and still more serviceability.

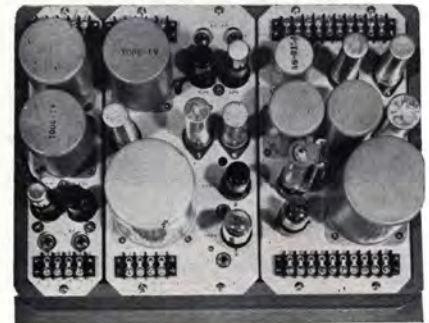

Any combination of amplifiers or power supplies may be mounted on one rack housing. This illustrates a preamplifier, program amplifier, and power supply all on one SA-800 housing.

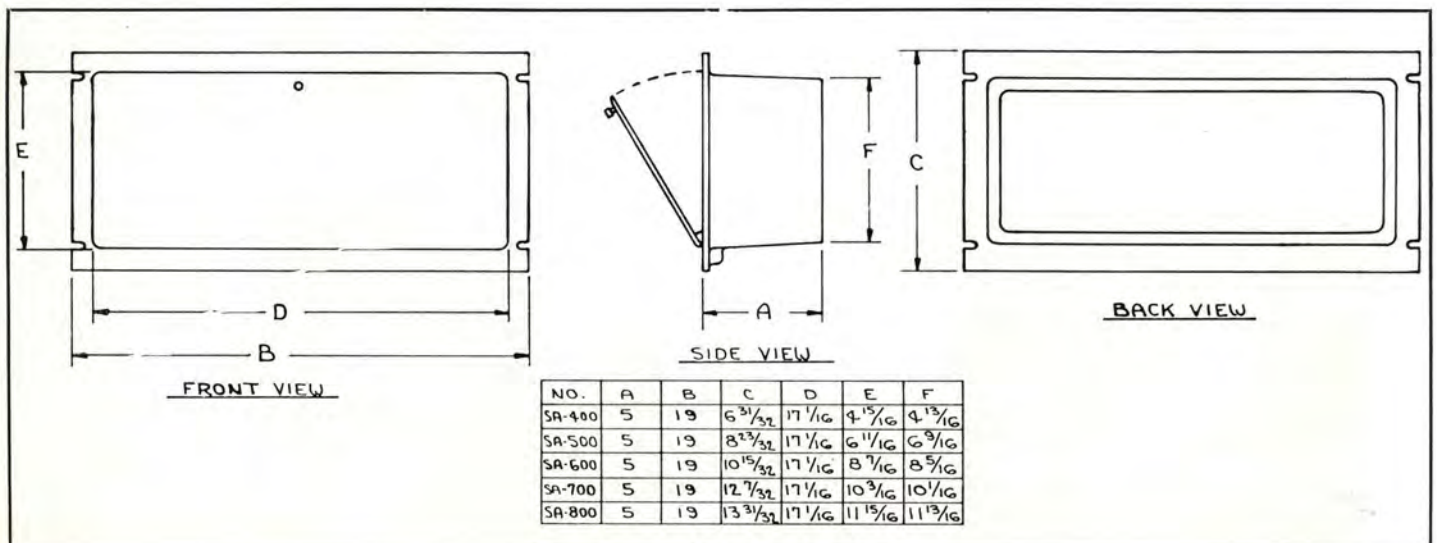

Mobile Sound Effects Console



In program production, the sound effects wagon plays a very important part. The CSE-9 sound effects console has been designed with the thought in mind to provide the sound department with a unit having every modern feature, handling ease, and the same quick serviceability, in case of trouble, that will be found on any modern up-to-date speech input system.

Study of the functional diagram on Page 156 will disclose a great amount of detail. Six input circuits, two for microphones and four for pickups, feed into a program amplifier as well as a monitoring amplifier. Each of these six channels has ladder attenuators with cue position at infinity. This cue output feeds into a split headphone arrangement. Four circuits are handled: (1) program cue, (2) sound effects cue, (3) sound effects out, and (4) director's cue. The two microphone channels are provided with PRE1 plug-in preamplifiers, and the four pickup channels are provided

(continued next page)

MOBILE SOUND EFFECTS CONSOLE

(continued from preceding page)



Above, CSE-9 sound effects equipment with top closed.

Open view is on Page 155.



Dual loudspeaker on mobile dolly, type LSB-2.

with PRE3 preamplifiers with high and low roll-off, described on Page 129. In addition to individual equalization of each pickup, a master sound effects filter is provided, with complete high and low roll-off. — It can be said with accuracy that any type of response curve may be obtained to provide the effect desired.

Turntables are adjustable to any speed from 25 to 100 rpm. Standard speeds of 33 $\frac{1}{3}$, 45 and 78 rpm are identified. Turntables are rim drive. Each transcription arm is provided with spotting light. Each turntable will accommodate two transcription arms for continuous effects. — All amplifiers and power supplies are of the plug-in type. Knobs for attenuators and key switches are color coded for easy identification. Terminations are made to receptacles located on both sides of the cabinet. Cabinet is rigidly constructed of light metals to assure easy mobility on the silent rubber-tired wheels that may be locked in place for permanence. Bottom section of cabinet is for storage. Front control panel hinges down for servicing. When not in use, the plexiglass copy stand (illustration, Page 155) pulls up and over the turntables and control panel (illustrated above, left).

The type LSB-2 loudspeaker shown to the left is recommended for use with the CSE-9 sound effects console; but, of course, any suitable speaker may be used. — Size of speaker: 60"x36"x18" deep. Size of sound effects console: 60"x27 $\frac{1}{2}$ "x48" high.

Sound effects console complete with tubes but less speaker. Loudspeaker on mobile dolly, as illustrated. 100% set of tubes for sound effects console.

Cat. CSE-9
Cat. LSB-2
Cat. TK-155

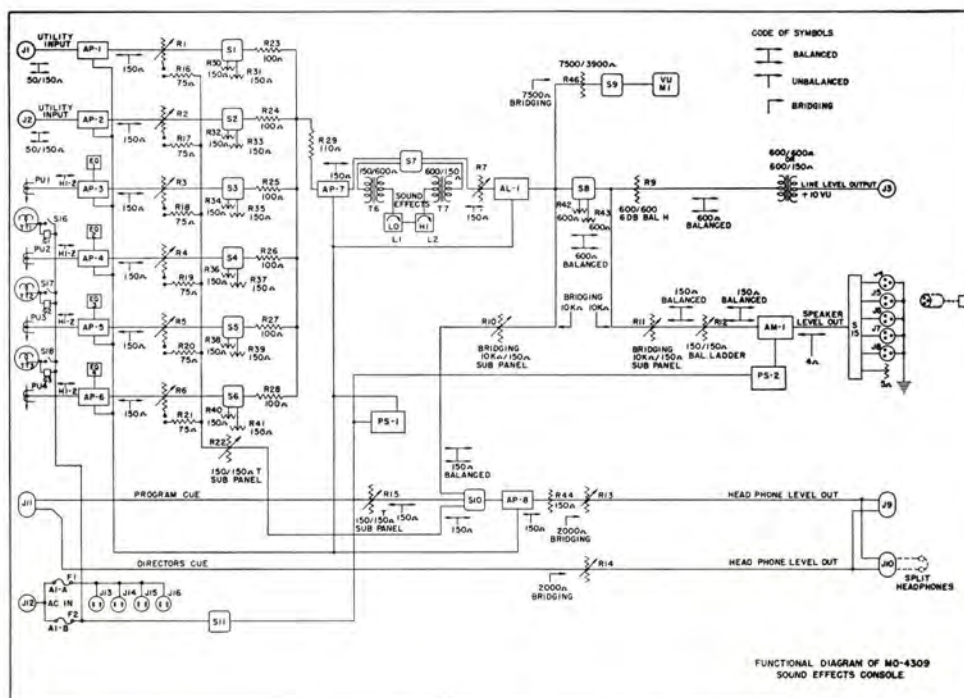

Transcription Turntable Equipment



CB-11 Chassis

This chassis, which is basic for all Gates turntables, employs the uni-power drive illustrated below. The unique shear action neoprene drive wheel (Figure A) virtually eliminates noise conduction between the motor drive pulley and the inside rim of the platter. Also, note the mechanical construction of the one-piece aluminum chassis where ribs and reinforcement have been scientifically studied for less rumble. The motor is a special, dynamically balanced, synchronous, capacitor start, quiet operating unit. The speed shifting mechanism is as simple as turning a switch. Throw in one direction for $33\frac{1}{3}$ RPM and the opposite for 78 RPM. A slip-on capstan is provided so that the $33\frac{1}{3}$ RPM speed may be changed to 45 RPM in a matter of a second. A micro-switch is attached to the speed change lever which automatically turns on and off the motor when the drive wheels are engaged.

Size: $21\frac{1}{4}$ " square and 3" from bottom of casting to top of guard. Accuracy, 0.4% or better over extended periods. Lateral or vertical noise, 40 dbm or better below average sound track. Cue allowance, $\frac{1}{8}$ rpm ahead of sound track for $33\frac{1}{3}$ speed. Power requirements, 115 volts, 60 cycles (50 cycles on special order), 60 watts.

CB-14 Transcription Turntable

Illustrated above. This practical and beautifully styled equipment will be found in most radio stations—perhaps, more than any other style turntable. Cabinet 5-ply, finished in gray and black lacquer. Levelling screws provided. Consists of CB-11 chassis, reluctance pickup head with diamond stylus, Gray 602 variable equalizer and choice of arms. See Page 151 for SA-134 amplifier. Size of cabinet: 29" high (adjustable to 31") and 22" square, with removable back door.

- Turntable with 106-SP arm, 602 equalizer and RPJ-002 diamond stylus.** Cat. CB-14A
- Turntable, same as above with SA-134 preamplifier added.** Cat. CB-14B
- Turntable with 108-B arm, 602 equalizer and RPJ-002 diamond stylus.** Cat. CB-14M
- Turntable CB-14M with SA-134 preamplifier added.** Cat. CB-14N
- Turntable chassis only.** Cat. CB-11

Note: See Page 161 for pickup and filter detail. Other pickups of your choice may be adapted to CB-14 equipment.

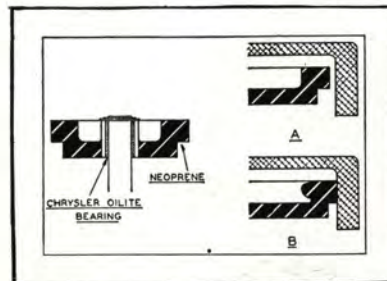
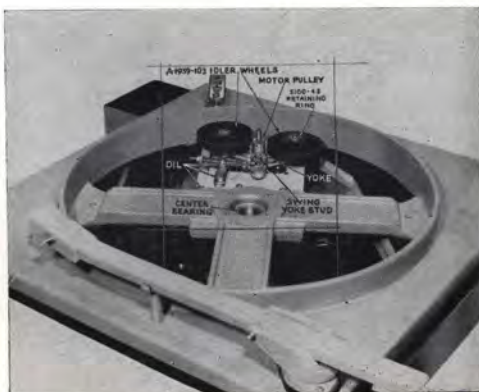

Figure A—Shear action of drive pulleys means drive pressure against air (illustrated above). To right, the speed change and master starting lever.



Type CB-4 Horseshoe Control Desk



Any standard speech console will fit nicely, to provide finger tip control.

Where modern design, smart appearance, and operator convenience are desired — this desk is the answer.

Broadcasters who travel a bit have seen this fine control room desk. Since its introduction, the CB-4 desk has been standard equipment in America's finest radio stations. Built of 7-ply seasoned wood and finished in gray lacquer. Top is covered with battleship linoleum. Each wing is a large, roomy compartment that may be used for amplifiers, record storage or both. Width of each wing is such that 19" rack panels may be accommodated. Each wing has a hinged front door and a removable back panel. Size: 84" wide, 48" from front to back and 30" high.

The front portion of each wing will accommodate the CB-11 turntable chassis listed on Page 157. These may be equipped with any pickup, such as the more popular styles listed on Page 161. The speech input console may be any style listed in this catalog. Likewise, competitive makes will fit perfectly into place. When ordered with turntables, the motor starting switches are supplied for mounting on the inside of each wing.

Horseshoe desk without cutouts or equipment.

Cat. CB-4

Horseshoe desk with two CB-11 turntable, 106-SP arm, 602 equalizer and diamond stylus reluctance pickup heads.

Cat. CB-4A

Horseshoe desk, same as CB-4A above but with two SA-134 preamplifiers included (see Page 151).

Cat. CB-4B

Estimated shipping weight, less turntables: 490 lbs. Cubage: 120. Accessories referred to above are supplied unmounted in desk.

Below, the CB-4 desk, illustrating large roomy compartments for mounting accessories, or for storage. The backs of each wing are also removable.



TRANSCRIPTION TURNTABLES



Audition-Transcription Equipment

This equipment is similar to the CB-14 transcription equipment listed on Page 157, but has complete audition facilities added. A high quality ten-inch loudspeaker and a high fidelity 2-watt amplifier are added to the complete CB-14B turntable. This, then, provides a standard transcription turntable with preamplifier, plus the audition amplifier and self-contained loudspeaker. Large baffle area of cabinet develops beautiful tonal quality. Gain control on side for loudspeaker volume. Includes Gray 106-SP arm, 602 filter, diamond stylus reluctance pickup, SA-134 amplifier, 2-watt speaker amplifier and loudspeaker. Size: Same as CB-14, Page 157.

Audition-Transcription turntable with tubes.
100% set of tubes for above.

Cat. CB-15
Cat. TK-156

Portable Transcription Equipment

Here is perhaps the only portable commercial transcription unit manufactured. Designed primarily for military use, it has many other applications as well. Consists of CB-11 chassis, described on Page 157, with Gray 106-SP arm, 602 variable equalizer and diamond stylus reluctance head. May be purchased with or without SA-134 preamplifier, as described on Page 151. Output impedance 250 ohms. Output level, less preamplifier, -67 dbm. Size: 24" square and 16 $\frac{3}{8}$ " high with lid in place. Finish: Army khaki. Case constructed of seasoned 5-ply material with metal corner reinforcement.



Portable transcription equipment, less preamplifier. Cat. CB-16
Portable transcription equipment, with preamplifier. Cat. CB-16A
100% set of tubes for model CB-16A. Cat. TK-107

Presto Model 15-G Turntable



Consists of a chassis, 12" cast aluminum machined and balanced turntable, high quality motor, and inside rim drive mechanism. Operates at all three speeds of 33 $\frac{1}{3}$, 45 and 78 RPM. A turntable of commercial quality in the medium price bracket that is particularly well suited for playing 45 RPM records. Speed variation 0.5% or less. Operates from 115 volts, 60 cycles. Size overall: 13 $\frac{1}{2}$ " wide and 11 $\frac{7}{8}$ " deep.

Presto 3-speed 12" turntable chassis.

Cat. 15-G

Presto Model 64-A Turntable



A truly fine, direct gear driven, dual speed turntable. Mechanical filter reduces noise or rumble to 50 db below program level. Speed variation is stated as zero. Two 1800 RPM synchronous motors, one for 33 $\frac{1}{3}$ RPM and one for 78.26 RPM, are selected electrically and require no mechanical shift. Only one motor at a time can operate. Maintenance requirements consist only of lubrication. Standard equipment includes complete turntable mechanics and cabinet. Pickups, filter or arm may be selected by consulting Page 161. Size: 24" square and 33" high overall. Shipping weight: 266 lbs. Cubage: 26. Power consumption: 75 watts from 115 volt, 60 cycle line.

Presto direct drive dual speed turntable with cabinet.

Cat. 64-A

TRANSCRIPTION TURNTABLES, RECORDING, PLAYERS

Three-speed Transcription Chassis

Select the speed you want by a lever on the front of the turntable. For 45 RPM, a disappearing adapter to accommodate the larger spindle size raises into position, and drops flush with platter for smaller spindle records and transcriptions. Turntable is cast aluminum and carefully machined. Base is drilled for Gray pickups as listed on Page 161—other types may be easily mounted. Platter size: 16". Noise: 50 db below program level. Meets NARTB standards for speed variation and wow. Uses hysteresis synchronous 116 volt, 60 cycle motor. Size: 20" wide, 18 $\frac{3}{4}$ " deep, 1 $\frac{1}{2}$ " above base and 6" below base. Shipping weight: 30 lbs. Made by Rek-O-Kut.

Three-speed commercial transcription chassis.

Cat. B-16H



Variable-speed Turntable

Ideal for sound effects equipments, though may be used with excellent results as record player. Variable, by lever on front, from 25 to 100 RPM. Standard speeds of 33 $\frac{1}{3}$, 45 and 78 RPM are marked. Operates inside rim drive with cone type drive wheel to obtain variable speed. Size: 16" long, 12" wide, 1 $\frac{1}{2}$ " above chassis and 5" below chassis. For 115 volts, 60 cycles. Made by Rek-O-Kut. Has 12" platter.

Variable-speed turntable. Cat. LP-743



Disc Recorder (12" turntable)

A fine 2" dual-speed disc recorder that will produce professional results. Turntable is aluminum, lathe turned and balanced. Shock suspended synchronous motor for 115 volts, 60 cycles.

Rim drive. Instantaneous speed change. Records inside-out or outside-in by choice of lead screws. Magnetic cutter 8 ohms and flat from 40-7000 cycles.

Recording turntable only, less overhead recorder. Cat. TR-12H
Overhead mechanism for 108 lines per inch. Cat. M12-108
Overhead mechanism for 120 lines per inch. Cat. M12-120
Overhead mechanism for 192 lines per inch. Cat. M12-192 (microgroove)



Disc Recorder (16" turntable)

Here is a heavy, rim drive recording turntable, available with overhead mechanism, that will satisfy professional users. Synchronous motor; shock mounted, 115 volts, 60 cycles. Platter: aluminum, lathe turned and balanced. Chassis: cast

iron, ribbed L beam. Instantaneous speed change. Size: 20" square, 2 $\frac{1}{2}$ " above chassis and 5" below chassis. Overhead mechanism has tilt and level adjustment, dual clutch spiraling control, micrometer depth adjustment, stainless steel lead screw, adjustable angle cut, and completely enclosed drive gears. Cutter: 8 ohms, flat 40-7000 cycles. When ordering overhead mechanisms, state whether for inside-out or vice versa.

Recording turntable only, less overhead mechanism. Cat. Model V
Overhead mechanism for 105 lines per inch. Cat. MS-105
Overhead mechanism for 120 lines per inch. Cat. MS-120
Overhead mechanism for 210 lines per inch. Cat. MS-210 (microgroove)



Overhead Recording Mechanisms

When ordering overhead recorders, please be sure to state lines per inch for the lead screws, and whether recording is inside-out or outside-in. Magnetic recording heads are supplied in all instances. Stylus should be provided by purchaser for type of recording desired, such as standard or microgroove.

Deluxe Auditioning Equipment (For all 3 speeds)

A truly fine auditioning equipment. Plays 7" to 16" recordings at 33 $\frac{1}{3}$, 45 or 78 RPM. Wrist action pickup with adjustable needle pressure. Variable reluctance cartridge with dual sapphire styli. Hi-Fi amplifier with 6 watts undistorted output (10 watts peak). Tone control boosts or attenuates, both bass and treble. Mixer for both microphone and phone. 12" speaker. Bass compensated volume control. Shipping weight: 25 lbs.

Audition equipment with tubes. Cat. 12-VP2



Transcription Player (3-speed)

This model will perform well, and is in the medium price range. Plays all speeds and records up to 16" in size. Wrist action pickup. 2 $\frac{1}{2}$ watt amplifier (4 watts peak). 8" loudspeaker with 10' cord. Adjustable bass and treble control. Bass compensated volume control. Shipping weight: 15 lbs.

Transcription player with tubes. Cat. 6-U



Audition Unit

This model is similar to 6-U above but has microphone mixer added. 4 watt (6 watts peak) amplifier. Plays all three speeds, with wrist action pickup, treble and bass control, bass compensated volume control and 8" speaker with 10' cord. Shipping weight: 20 lbs.

Audition unit with tubes. Cat. 10-P2



Needle Force Gauge



A simple and effective instrument to measure actual pressure of stylus or pickup head applied to groove of record. A must in every business that uses records or transcriptions commercially.

Needle pressure gauge. Cat. 301

Transcription Pickups, Filters, Recording Head, Accessories



Gray 106-SP Transcription Arm

Now used on all Gates transcription turntables unless otherwise specified. Use one arm for all three record speeds. Quick cartridge change without tools. Natural resonance way below standard recording limits. Precise adjustable stylus pressure. Adjustable pivot height. Low vertical inertia. Three slides provided, to accommodate GE 1 mil, 2½ mil or 3 mil cartridges. For cartridges and styli, see listing below. For records up to 16".

Transcription arm less cartridge or stylus. **Cat. 106-SP**

Gray Viscous Damped Arm

A far-reaching advance in the suspension principle for perfect tracking and virtual elimination of tone arm resonances. Plug-in feature allows fast change from standard to microgroove. Stylus pressure, 5 grams. Damping is adjustable. Prevents damage due to dropping. For cartridges and styli, see listing below.

Transcription arm less cartridge or stylus. **Cat. 108-B**



Gray Model 602 Equalizer

Used with above choice of arms, and cartridges listed below, to develop all commonly used curves. Has four positions: (1) flat, (2) roll off at 3000 cycles, (3) orthocoustic, and (4) sharp roll off for noisy records. Output impedance 250 ohms. Insertion loss 20 db; or, when used with cartridges below, output -67 dbm at 4.7 cm/sec. 18" cable provided between filter switch and filter case. Completely shielded for freedom from hum pickup.

Equalizer complete. **Cat. 602**



Disc Recording Head (Presto 1-D)

In disc recording heads, the Presto 1-D is recognized as professional all the way. The cutting head response from 50-10,000 cycles is essentially flat. Distortion is held extremely low through the unique damping and design arrangement. Available in either 16 ohm or 500 ohm types. Used on most of the Presto recorders listed on subsequent pages.

Recording head, 16 ohm impedance.
Cat. 1-D-16

Recording head, 500 ohms impedance.
Cat. 1-D-500

FOR PREAMPLIFIERS

Preamplifiers for use with the above transcription pickups will be found listed on Pages 129 and 151.

Dual Stylus Reluctance Cartridge RPX-047

Two styli may be inserted to offer triple play for all speeds, standard or microgroove. Turn knob on front to change stylus position. Same characteristics as RPX-046 above.

Dual reluctance cartridge.
Cat. RPX-047

Variable Reluctance Cartridge RPX-046

For use with above arms and filter. Resistance 220 ohms, inductance 250 mh. Supplied less stylus, and either diamond or sapphire may be used (as listed below). The marvelous performance of this pickup head is world renowned.

Pickup cartridge less stylus.
Cat. RPX-046

Chip Chaser



Prevents recording chips from winding around overhead post or drive pin. Heavy base holds in place. May be used with any turntable. Will not damage recording.

Chip chaser. **Cat. CH-1**

Tape Splicer



A unique and indispensable item for editing and splicing recording tape. Consists of rectangular rod of duraluminum, which has a longitudinal groove with a curved bottom machined to mirror finish. Holds tape securely while transverse grooves are provided for cutting blade.

Tape editing and splicing unit.
Cat. Edit-11

Styli for Reluctance Cartridges

For use with RPX-046 Cartridge

Cat. No.	Stylus	Stylus Radius in inches
RPJ-001	Sapphire	.003
RPJ-005	Sapphire	.001
RPJ-006	Sapphire	.0025
RPJ-002	Diamond	.0025
RPJ-003	Diamond	.003
RPJ-004	Diamond	.001

For use with RPX-047 Cartridge

Cat. No.	Stylus	Stylus Radius in inches
RPJ-007	Sapphire	1 mil and 2.5 mil combination
RPJ-010	Sapphire	.1 mil and 3 mil combination
RPJ-011	Diamond	1 mil and 2.5 mil combination
RPJ-012	Diamond	1 and 3 mil combination

MORE PICKUP ARMS ON PAGE 206

RECORD AND TAPE LIBRARY CABINETS

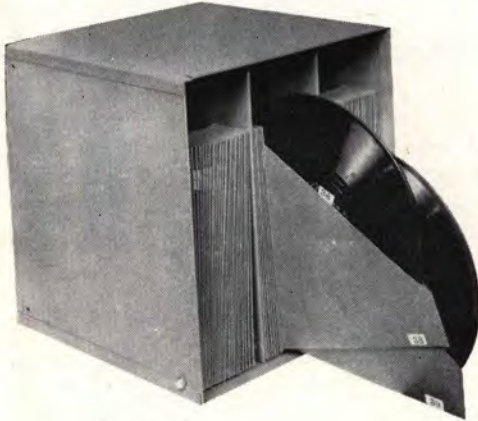

Fig. 1

The famous Discabinet System that cuts in half the time necessary to prepare and return a record show to storage. Saves floor space, eliminates breakage or marring. Record pockets are held by a rod, and have brass inserts so they will swing out freely (see Fig. 6 below). Constructed of 20 gg steel. Each section has three compartments, holding 30 discs each, or 90 in all. Bolt compartments together, as required, with hardware supplied. Finished in gray ripple enamel.

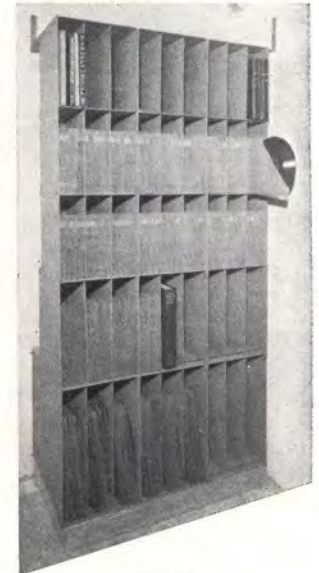

Fig. 2

Discabinets Are Furnished In Four Sizes

SIZE OF RECORD	CATALOG NUMBER	SIZE OF CABINET			POCKET CAPACITY
		WIDE	HIGH	DEEP	
7"	A-7	13 1/8"	9"	9"	90
10"	B-10	13 1/8"	12 5/8"	12"	90
12"	C-12	13 1/8"	15 5/8"	14"	90
16"	D-16	13 1/8"	20 5/8"	20"	90

Figure 2, to right

Illustrates how Discabinets can be assembled in various combinations. This arrangement will hold a total of 1350 discs, 270 16" discs, 270 12" discs and 810 10" discs. Any combination can be worked out by assembling sections as listed above.

Figure 3, to right

A complete reel storage cabinet with double front doors and lock. Size: 52" high, 29" wide, 10" deep. Type 5384 handles 384 5" reels and Type 7288 accommodates 288 7" reels. May also be used for 16 mm film reels in TV.

Tape storage cabinet for 5" reels.
Cat. 5384

Tape storage cabinet for 7" reels.
Cat. 7288

Figure 4, below

Sectional cabinet for 10 1/2" tape reels. 13 1/8" wide, 12 5/8" high, 12" deep. Holds total of 21 reels. Bolt any number together vertically or horizontally.

Sectional tape cabinet. Cat. 1021

Figure 5, below

Sectional tape cabinet in two sizes: for 5" or 7" tape reels. Bolt as many together as you desire. Type 542: 1/8" wide, 12 5/8" high, 8 5/8" deep. Type 742: 13 1/8" wide, 16 1/2" high, 8 5/8" deep.

Sectional cabinet for 5" tape reels.
Cat. 542

Sectional cabinet for 7" tape reels.
Cat. 742



Fig. 3



Fig. 4



Fig. 5



Fig. 6

CUSTOM DESKS FOR STUDIO EQUIPMENT

Models CB-60 and CB-60A

Model CB-60, designed specifically for use with SA-40 and SA-50 speech equipments listed on Pages 134-138. Model CB-60A has no cutout in top, and may be used with any speech console. Illustrated Fig. A and B. Contour is such that turntables fit to each side, at exact arm's length. Where used with SA-40 or SA-50 consoles, the chassis pivots on each end and swings up for under-chassis servicing. Duct, down inside back, conceals wiring. Joiner cables listed below are to connect terminal board on console to terminal board on inside back of CB-60 desk. Size: 74" greatest width, 35" greatest depth and 29" high. Steel construction, with 5-ply top covered with heavy dull black linoleum. Supplied with leveling screws. Finish, gray. Model CB-60 is provided with hinged top for SA-40 or SA-50 consoles.

Desk for use with SA-40 or SA-50 console, including hinged console top. **Cat. CB-60**

Joiner cable to connect SA-40 console to CB-60 desk terminal boards. **Cat. CP-95**

Joiner cable to connect SA-50 console to CB-60 desk terminal boards. **Cat. CP-94**

Desk, same as CB-60, but with no cutout in top, for use with any console. **Cat. CB-60A**



Fig. A

Model CB-62

Illustrated Fig. C, supplied with side angles and top so that two sections of 19"x14" rack panel space are provided. Top cutout for back extension of equipment. Panels on 45° angle. Though illustrated with tape recorders, any rack panel equipment may be used, such as for transmitter controls, etc. Size: 48" wide, 30" high and 26" front to back. Wiring duct down inside back. Constructed of steel, with 5-ply top covered with dull black linoleum. Finish gray. Leveling screws provided.

Desk with angles and top cover. **Cat. CB-62**

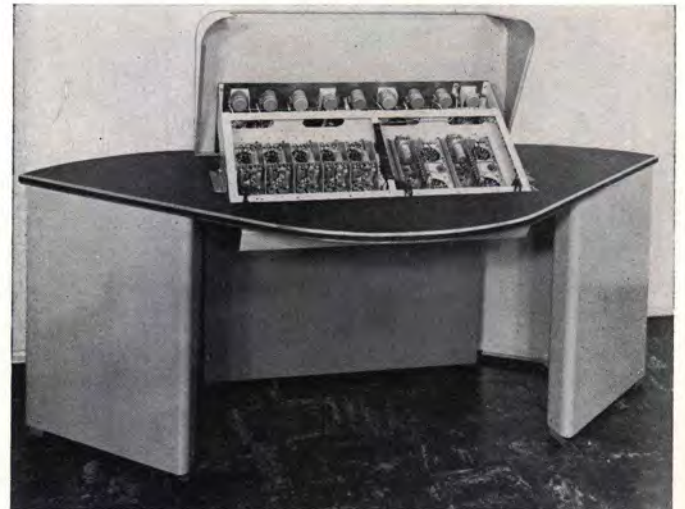

Fig. B

Models CB-62A and CB-63

Illustrated Fig. D, chair and console for illustrative purposes only. Designed to accommodate any standard speech input console, and to provide modern styling. Made of steel, with 5-ply top covered with dull black linoleum. Wiring duct down inside back. Leveling screws provided. Size: 48" wide and 30" high. CB-62A is 26" from front to back. CB-63 is 32" from front to back. Finish, gray.

Desk complete, depth 26" front to back.

Cat. CB-62A

Desk complete, depth 32" front to back.

Cat. CB-63



Fig. D

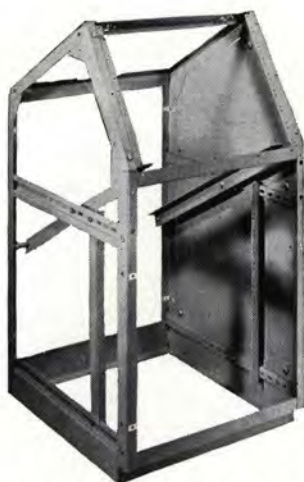

Fig. C

Sectionalized Control Desks



Any number of standard sections may be assembled to provide a control desk of any desired size and contour—in the latest modern design and with a beautiful commercial appearance. Each basic unit or section includes the frame, as illustrated below, plus top and back covers, front panels, equipment mounting angles, trim strips, and hardware. The various other items to complete the multiple assembly are listed below under “Ordering Data.” For complete details refer to the drawing on the next page. Each section has a top panel mounting space of 19”x14” and a lower panel mounting space of 19”x21”. The lower section has adjustable mounting angles over a space of 14⁵/₈” from front to rear. Shelves or desk portion available either in metal or Formica. Metal shelves are finished in gray to match desk color. Formica shelves are in rich maroon. — For TV or radio, these new Gates sectionalized desks are the very latest. By following a standardized design, production economies allow a much lower price than ordinarily expected for this style of equipment.



Above, basic section with top, back cover, and front panel removed. Electrical shield is mounted on right side, and is used as needed.

Ordering Data

(see Page 165 for drawing)

Symbol	Description	Cat. No.
A	Basic control desk section, includes frame illustrated at left, top and back covers, lower front panels, equipment mounting angles, trim strips and hardware.	M-4356
H	Left end bell for desk section with hardware.	M-4437
H	Right end bell for desk section with hardware.	M-4438
N	Standard shelf support with hardware.	M-4439
P	Angle shelf support with hardware.	M-4440
K	Right shelf end bell with hardware.	M-4441
K	Left shelf end bell with hardware.	M-4442
C	Standard metal shelf.	M-4443
B	Standard Formica (maroon) shelf.	M-4444
E	Angle shelf, metal.	M-4445
D	Angle shelf, Formica (maroon).	M-4446
F-G	Fill piece and back cover with hardware.	M-4447
none	Electrical shield (shown attached to frame at left).	AHT-12
L	Angular trim piece, 22 ¹ / ₂ degree.	AHT-13
M	Angular trim piece, 45 degree.	AHT-14

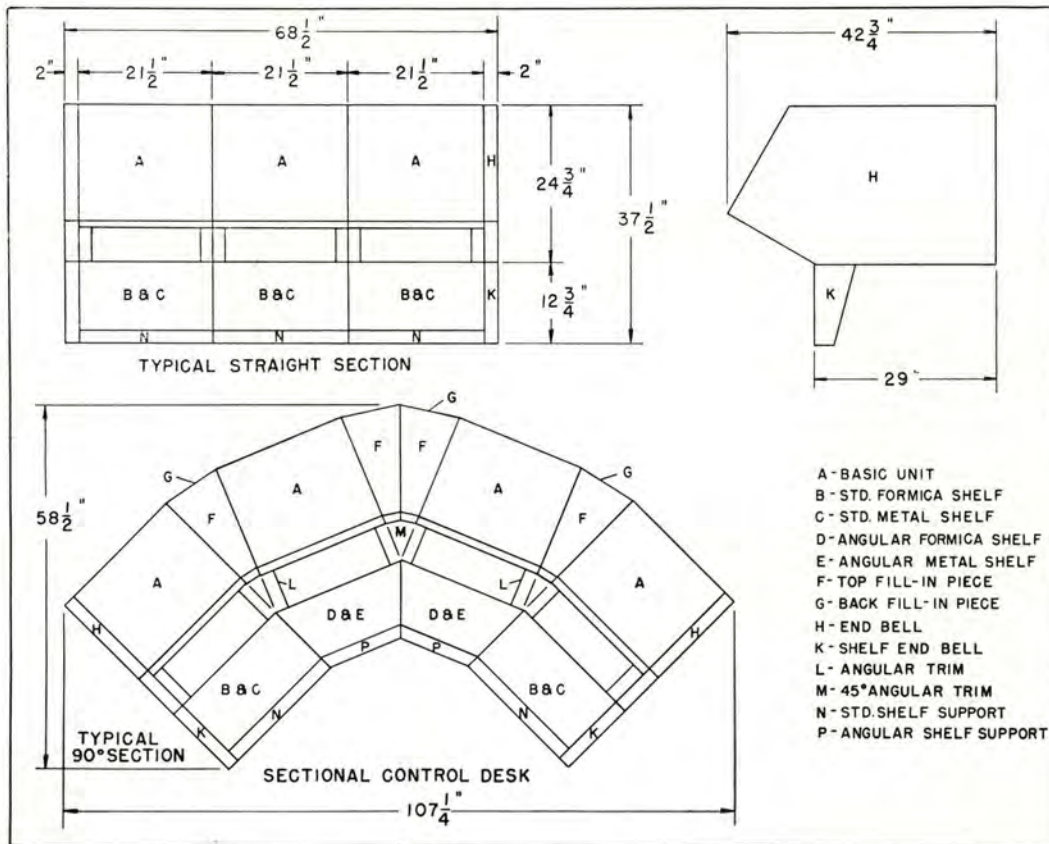

Dimensional drawing of sectionalized control desk, Page 164.



STUDIO WARNING LIGHTS

Here is a conservative, yet highly attractive and necessary fixture in the radio and TV station. Letters are placed on plexiglass, which transfers light rays edgewise through the glass and illuminates letters only. All lights except the "On Air" fixture have fluorescent tubes in yellow, providing gold lettering. The "On Air" fixture has an incandescent light and illuminates in red. Metal portion is steel with bronze finish. Conduit knockouts provided. "On Air" fixture will attach to bottom of any studio fixture.

- | | |
|--|-----------|
| Warning light reading "Studio A". | Cat. AM-1 |
| Warning light reading "Studio B". | Cat. AM-2 |
| Warning light reading "Control Room". | Cat. AM-3 |
| Warning light reading "On Air". | Cat. AM-4 |
| Warning light with any special lettering up to 14 letters. | Cat. AM-5 |
| Warning light reading "Gentlemen". | Cat. AM-6 |
| Warning light reading "Ladies". | Cat. AM-7 |

Gates Will Shop For You

Let Gates people, located everywhere, shop for you. If you need that unusual article, or if you just don't have time to go shopping yourself, then let Gates shop for you. No charge, of course. All in a day's work, and part of the service that Gates is obligated to give its many customers. Actually, in many cases shopping is unnecessary, because over 15,000 items are carried in our stock, most of which do not even appear in this catalog.



STUDIO CLOCKS

Above, the large and commercially attractive Sessions self-starting electric clock. Has 14" metal dial with jet black numerals and hands. Easy to read sweep second hand. Overall diameter, 17". Convenient bottom set.

Sessions 17" clock. Cat. 438-W



Seth Thomas is a famous name in fine clocks. Only 1 3/4" thick. Has convex dial and hands. Numerals and hands in jet black, with second hand in red. Has red current interruption indicator. Sets at bottom. Dial 12 1/2". Overall diameter, 15".

Seth Thomas 15" clock. Cat. 12-B

COMMERCIAL DISC RECORDERS



Model 66-G Recorder

(by Presto)

Here is an unexcelled commercial recorder for broadcasting stations or recording studios. Includes the famous Presto dual motor drive, providing exact timing with zero speed deviation for $33\frac{1}{3}$ and 78 RPM. Overhead mechanism consists of well known Presto type 166-N, including 1-D high fidelity cutter, 15-B spiraling feed screw, 170-A vertical dampener and 2-A time scale. Supplied as standard for 112 lines per inch inside to out recording. Also available are feed screws for 96, 104, 120, 136 line for standard recording and 244, 256 and 288 lines for microgroove, either inside to out or outside to in. Recording amplifiers on Page 167 are recommended; and if desired, the automatic diameter equalizers listed at bottom of page may be added. Cabinet size: $25\frac{1}{2}$ " wide, $24\frac{1}{2}$ " deep, $38\frac{1}{2}$ " high. Finish: 2-tone gray. Weight: 267 lbs. Noise: 50 db below program level. For cutter detail, see Page 161. — State impedance of cutter and feed screw pitch and direction when ordering.

Disc recorder with cabinet, overhead mechanism, and 1-D cutting head.
Cat. 66-G

Model 6-N Portable Recorder

(by Presto)

This recorder is perhaps the most popular of all in radio stations around the world. The weight of 82 lbs. is considered minimum without sacrifice of quality. Standard equipment includes the complete overhead mechanism, 1-D cutter, and choice of feed screws as listed under the 66-G recorder above. Where not otherwise specified, 112 lines per inch inside to out recording will be supplied. Noise level 40 db below program level. Speed accuracy of 0.5% at either 78 or $33\frac{1}{3}$ RPM; and regulation within a single revolution is accurate to 0.25%. Size with case enclosed: $20\frac{1}{4}$ " x 20" x 15". Finish: gray leatherette. For detail on 1-D cutter, see Page 161. May be used with automatic diameter equalizers, listed at bottom of this page, and recording amplifiers on Page 167.

Portable disc recorder with carrying case, overhead mechanism, and 1-D cutter.
Cat. 6-N



Model K Recorder

The K-10 portable recorder embodies both standard and microgroove recording for discs up to $33\frac{1}{4}$ " in size. Though particularly popular in schools and colleges, the K-10 is extensively used elsewhere. Standard equipment includes 12" dual speed turntable for recording and playback, magnetic cutting head, cutter feed mechanism, playback pickup, 5-stage recording amplifier, and loudspeaker — all mounted in an attractive leatherette covered carrying case. Cutting pitch is 112 and 224 lines per inch inside to out recording. Controls include volume indicator, high frequency equalizer and tone control, dual volume control, and record playback selector switch. The K-10 may also be used as a public address system. Size: $19\frac{1}{2}$ " x $15\frac{1}{2}$ " x 14" case closed. Shipping weight: 69 lbs.

Complete recorder with tubes, ready to use, less microphone. Cat. K-10

Automatic Diameter Equalizers

Attaches to overhead mechanism of either the 66-G or 6-N recorder, listed above, to pre-emphasize high frequencies so as to compensate for loss of these frequencies when recording near the center of the disc at $33\frac{1}{3}$ RPM. Consists of a group of contacts and a slider which attaches to the recording head carriage. Comes in two units: the overhead and external tuned equalizer cabinet.

Equalizer for 1 turntable, consists of 1 slider unit and 1 equalizer.

Cat. 160-A

Equalizer for 2 turntables, consists of 2 slider units and 1 equalizer.

Cat. 160-B

Equalizer slider unit only, for use with 90-B or 92-B amplifiers, listed next page. Cat. 161-A

RECORDING AMPLIFIERS — SPRING WOUND TAPE RECORDER



Model 90-B Recording Amplifier

For all-in-one recording amplifier requirements, the Presto 90-B is both excellent and convenient. Provides three microphone channels (250 ohms), equalizer control for disc recording, switching for dual turntables, input and output controls, and large 4" VU meter. Equalizing includes NARTB 78 RPM or flat, playback for NARTB 78 or flat, for pre-emphasis and de-emphasis of treble and pre-emphasis of bass and for connection to Presto 161-A diameter equalizer (the 161-A is slider portion only), see preceding page. Gain: 115 db. Noise: 60 db or better below program. Distortion: 1½% at 10 watts output. Response: within 1 db 30-15,000 cps. Tubes: six 6SJ7, two 6L6G, one each 6SQ7, 6SN7GT and 5U4G. Shipping weight: 94 lbs.

Recording amplifier with tubes.

Cat. 90-B

Model 92-B Recording Amplifier

Without question, the Royalty of recording amplifiers. Delivers 60 watts, with distortion less than 1½% at 50 watts. Ordinary power amplifiers, regardless of their excellence, are not designed to be unaffected by load changes as occur in disc recording. This is accomplished in the Presto 92-B by extreme low impedance and a large amount of feedback. Push-button equalizing selector, and the 60 watts output to handle high transient peaks, are both engineering requisites. Input: 500 or 15,000 ohms. Output: 500, 250, 15 and 6 ohms. Gain: 83 db at 500 ohm input. Noise: 60 db below program. Frequency response: 4 curves provided (a) flat 20-17,000 cps within 2 db, (b) complements 78 RPM playback having pre-emphasis, (c) complements NARTB lateral playback, and (d) for use with 161-A automatic equalizer on Page 166. Tubes: one each 6SF5, 6SN7GT, OD3/VR150, two each 6SJ7, 5R4GY, and four type 807. Size: 14"x19" rack panel space and 10" deep. Weight: 105 lbs.



Recording amplifier with tubes.

Cat. 92-B



Spring Wound, Self-powered Tape Recorder

Good tape recording is now possible without running down a set of batteries for each pickup, or the mess of a wet battery. A unique, heavily built, spring wound motor drives the mechanical portion. Will operate 15 minutes without rewind. May be rewind while in operation with less than 1% speed variation over 15 minutes. Two flashlight cells and one 67½ volt B battery operate the amplifier. One of the few portable tape recorders that rewind at high speed (44" per second). Records at 7½" per second. Will play back to headphone on location, no waiting to return to studio. Provided with erase head. There is no vibrator or commutator noise because there is no electric motor. Operates in any position. Strap provided to carry over shoulder, and will record with case closed while operator is walking. Can be monitored continuously by single headphone supplied. Microphone, high impedance Electro-Voice type 915 with Cannon XL-3-11 plug. Any other good microphone may be used, or it may be fed by a portable remote amplifier.

Complete recorder with tubes, batteries, microphone and single head set.
Cat. TPK-7

AMPEX TAPE RECORDERS

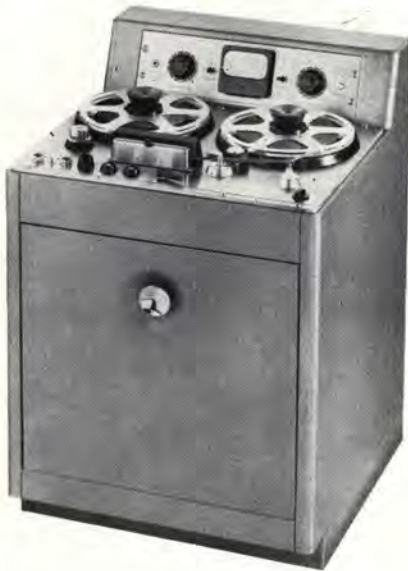

Model 300 Deluxe Console

There is no question that this model is the finest of the fine in tape recording equipment. Used in the majority of all network shows, in the film industry, in hundreds of radio stations, and as masters for disc recording. The reason is—complete dependability, superb workmanship and quality in materials and performance. Speeds: 15" and 7½" per second, with single speed change control that also changes equalization. Response at 7½" is within 4 db from 40-10,000 cycles, and even better on 15". Noise is reduced over 60 db. Starts to full speed in 1/10 sec. Stops with only 2" of tape travel. Accuracy ±3.6 sec. in 30 minutes. Playing time 66 min. at 7½" or 33 min. at 15"/sec. Will rewind 2400' in 1 minute. Tape may be monitored while recording. Input impedance: 10,000 ohms bridging, balanced or unbalanced. Output of playback amplifier: 600/150 ohms. Includes bridge input step control, and output step control, along with 4" VU meter, output key, and phone jack. Meter panel shown is an accessory. Shipping weight: Model 300, 270 lbs.

Console complete, less meter panel, for 115 volts, 60 cycles. **Cat. 300C-560C**
Console, same as above, but for 115 volts, 50 cycles. **Cat. 300C-3389**
Bridging meter control panel for series 300 recorder. **Cat. 515-2**

Model 300-S Deluxe Portable

This is identically the same equipment as supplied in the Model 300 above, but in portable form. Supplied in two cases as illustrated. Total weight, 175 lbs. Cases are ruggedly built for heavy duty service; and provided with large, firm gripping leather handles. Bridging input is 10,000 ohms, balanced or unbalanced. Matching input is 600/150 ohms.

Model 300-S portable recorder, bridging input, 115 volts, 60 cycles. **Cat. 4408-S**
Model 300-S, same as above, but matching input. **Cat. 4409-S**
Model 300-S portable recorder, matching input, 115 volts, 50 cycles. **Cat. 4424-S**
Model 300-S, same as above, but for bridging input. **Cat. 4423-S**



Type 400 Tape Recorder (with remote control)



The type 400 Ampex console tape recorder has the usual built-in Ampex dependability, along with a reserve capacity to handle heavy recording loads over long periods of time. Note complete serviceability with lift-up top plate, glide-out front panel, and tip-over chassis. Plays 64 minutes at 7½"/sec or 32 minutes at 15"/sec. Speed change switch also changes equalization. Rewinds 2400 feet in 1½ min. Has complete push-button control for start, stop, fast forward, and rewind. Meter is 4" VU, reading record input and output, plus bias and erase current. Meter is standard equipment. Response within 4 db 30-15,000 cycles at 7½"/sec. Input switch accommodates either low level microphone or 600 ohms. Output 600 ohms. Tape may be monitored while recording. Phone jack allows for monitoring input or recorded output signal. Remote control unit is an accessory and is illustrated below. Provides five remote functions of start, record, fast forward, rewind, and stop. Available for half or full track.



Type 400 recorder, half track, 115 volts, 60 cycles. **Cat. 3672**
 Same as above for 115 volts, 50 cycles. **Cat. 3672-1**
Type 400 recorder, full track, 115 volts, 60 cycles. **Cat. 3675**
 Same as above for 115 volts, 50 cycles. **Cat. 3675-1**
Remote control unit as illustrated. **Cat. 3766**



AMPEX TAPE RECORDING EQUIPMENT

Model 400-A Portable, One Case

Like the larger Ampex recorders, the model 400 recorder is a precision equipment throughout. The lower selling price is possible because of unique design. Built in one case and weighing only 80 lbs., which is modest for such a quality instrument. Has push-button operation for record, playback, fast forward, rewind, start and stop. Handles both RMA and NARTB reels. Records 64 min. at $7\frac{1}{2}$ " / sec, or 32 min. at 15" / sec. Output 600 ohms. Input for low level, low impedance microphone or bridging. Meter 4" VU. Signal to noise ratio, 55 db. Starting and stopping time, accuracy, frequency response, rewind time, and phone monitoring same as model 400 on Page 168. Size: 20"x17 $\frac{1}{2}$ "x15".



- | | |
|--|------------------|
| Portable recorder , half track, for 115 volts, 60 cycles. | Cat. 1048 |
| Same as above, but for 115 volts, 50 cycles. | Cat. 3377 |
| Portable recorder , full track, for 115 volts, 60 cycles. | Cat. 1996 |
| Same as above, but for 115 volts, 50 cycles. | Cat. 3379 |

Series 402 Portable, Two Case



This recorder has all the features of the 400 series console model, listed on Page 168, plus the optional availability of a 4-channel high level mixer. Illustration shows 4-channel mixer at bottom of right case. Total weight: both cases, approximately 132 lbs. Beautifully constructed. Cases connect with Cannon equipped cables. — Mixer is high level, each stage having a single stage preamplifier, and transformer input to accommodate impedances from 50 to 600 ohms. 20 step attenuators are employed. Tubes: 4 each 5879. Response: flat. Noise: 68 db below signal for input of -50 dbm. Size: 19"x7" rack panel space and 9" deep. When mixer is omitted, a blank panel is supplied.

- | | |
|--|--------------------|
| Portable recorder , less mixer, for 115 volts, 60 cycles. | Cat. 3677 |
| Same as above, but for 115 volts, 50 cycles. | Cat. 3677-1 |
| Four-channel mixer with tubes. | Cat. 3761 |

Speed Lock Equipment

This unit is designed to operate a tape recorder in exact step with motion picture film. The original sound portion of the sequence being photographed may be recorded on tape and later played back in full synchronism with the picture for copying or projection. Accurate within 1/40 of a single film frame. Available in rack or portable models. Space limitations herein do not allow full description, and it is suggested that those interested write Gates Radio Company for Bulletin P-219.



- | | |
|--------------------------------------|--------------------|
| Speed lock for rack mounting. | Cat. 2535-1 |
| Speed lock , portable type. | Cat. 2535-2 |

Precision Power Supply or Tuning Fork Amplifier



The Ampex tuning fork amplifier is suggested where absolute voltage and frequency must be maintained, such as in driving recording motors and stroboscopic timing devices. When operated from a source frequency between 50 and 400 cps, and a voltage between 90 and 135, it will supply 70 watts of power at exactly 60 cycles. Size: 19"x12 $\frac{1}{4}$ " rack space. Supplied with output voltage control, output voltmeter, and input jack in which external source may be inserted in place of the tuning fork to provide other operating frequencies.

- | | |
|---|-----------------|
| Precision power supply with tubes. | Cat. 841 |
|---|-----------------|

Ampex Stereophonic Recorder

Binaural recording by means of dual sound tracks, dual recorders and reproducers has created much interest and practical application in line with 3-dimension sound. The Ampex stereophonic recorder is provided for this purpose. Recording, playback, and monitoring of two channels simultaneously is developed through unusual location of the record and playback heads. Supplied complete with all necessary amplifiers, power supply, dual VU meters, and recording equipment; and having the same general characteristics as the 400 series listed on Page 168. Weight: all three cases, 138 lbs.



- | | |
|--|--------------------|
| Stereophonic recorder , for 115 volts, 60 cycles. | Cat. 4043 |
| Same as above, but for 115 volts, 50 cycles. | Cat. 4043-1 |

If You Didn't Get This From My Site,
Then It Was Stolen From...

MAGNECORD TAPE RECORDERS



Model PT63-AH Recorder

The finest in the Magnecord line, which means quality every step of the way. Has three heads: erase, record and playback. Illustrated at left above. Suggested use is with PT63-J amplifier, which is the unit at right above. Available for either 2 or 3 speeds, as listed below. Response: 50-7000 cycles at $7\frac{1}{2}$ " /sec, 50-15,000 cycles at 15" /sec and 50-4000 cycles at $3\frac{3}{4}$ " /sec. Signal to noise ratio: 50 db. Distortion: less than 2% at all frequencies. Accommodates 7" reels. 93X4 adaptor kit may be added (see next page) to handle $10\frac{1}{2}$ " reels. Connector cables are part of PT63-J amplifier shown at right. Portable case is beautifully styled, and covered with black leatherette. For 115 volts, 60 cycles. Has high speed forward. Rewinds 1200 feet in 40 seconds.

Recorder in carrying case for $7\frac{1}{2}$ " and 15" /sec tape speed.
Cat. **PT63-AH**

Recorder, same as above, with $3\frac{3}{4}$ " /sec speed added.

Cat. **PT63-A2H**

Plug-in equalizer for $3\frac{3}{4}$ " tape speed, needed for PT63-A2H.
Cat. **91-S-133**

Model PT63-J Amplifier

Illustrated above at right. The ideal companion unit to the PT63-AH recorder. Has separate record and playback amplifiers for simultaneous playback of tape while recording. Provides 10 watts of audio, with terminals for external speaker. Input is for either low impedance microphone or bridging. Has dual equalizers for either $7\frac{1}{2}$ " or 15" /sec. Switch selects bias, record or playback on VU meter. As panel size is 7"x9" the PT63-J may be removed from the case and rack mounted. Supplied with connecting cables for attaching to PT63-AH recorder mechanism.

Record and playback amplifier, with case.
Cat. **PT63-J**

Record and playback amplifier, less case.
Cat. **PT63-JX**

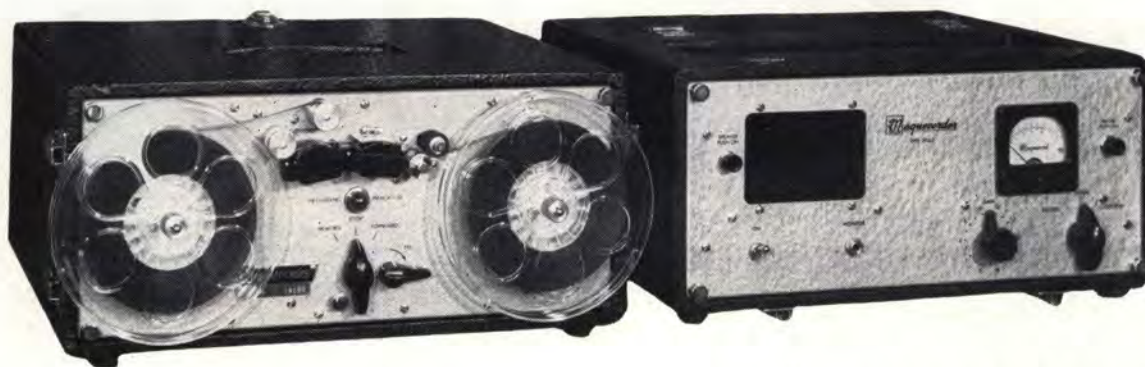

Type PT6-AH Recorder

There are thousands of this model in use. The PT6 series Magnecord is considered one of the best values in its price range. Has separate erase and record/reproduce heads, and includes capstans for either $7\frac{1}{2}$ " or 15" /sec. Also available for three speeds by adding $3\frac{3}{4}$ " capstan. Has high speed forward. May be used with 93X4 adaptor, listed on next page, to increase reel size to $10\frac{1}{2}$ " if the standard 7" reel size is not sufficient. Supplied in rugged leatherette finished case. Interconnecting cables are part of the PT6-J amplifier pictured at right. Performance specifications as to noise, response, etc., same as PT63-AH above.

Recorder in carrying case, for $7\frac{1}{2}$ " and 15" /sec.

Cat. **PT6-AH**

Recorder, same as above, with $3\frac{3}{4}$ " speed added.

Cat. **PT6-A2H**

Plug-in equalizer for $3\frac{3}{4}$ " tape speed, needed for PT6-A2H.
Cat. **91-S-133**

Type PT6-J Amplifier

Above, right—the companion unit to the PT6-AH recorder. Includes connecting cables for attaching to PT6-AH recorder. Has 10 watts output with terminals for external speaker. Provides input for low impedance microphone, as well as bridging. Output also provided at zero level for playback. Monitor speaker self-contained. Designed for all recording and playback requirements for high or low level. When ordering, state whether $7\frac{1}{2}$ " or 15" /sec equalizer desired. Housed in well built leatherette covered carrying case.

Tape recording amplifier complete.
Cat. **PT6-J**

Same as above, but less carrying case.
Cat. **PT6-JX**

MAGNECORD TAPE RECORDING EQUIPMENT



The Voyager

For professional recording, one case amplifier-recorder service, and modest selling price, the Voyager, weighing only 40 lbs. complete, answers every requirement. Consists of the PT6 series recorder, listed on Page 170, in combination with a new amplifier. Has low and high impedance microphone input, 600 ohm output at zero decibels, earphone monitor jack for both record and playback, VU meter, less than 2% distortion, 47 db signal to noise ratio—and all in a single, well built, leatherette carrying case.

Voyager tape recorder complete.

Cat. PT6-VAH

MagneCordette

Designed specifically for schools, colleges, or the home. Embodies all professional features of other Magnecord models, and includes as part equipment the PT6-AH mechanism listed on preceding page. Records at $7\frac{1}{2}$ " and 15 " /sec. Available on special order for $3\frac{3}{4}$ " /sec. Output is high impedance, to feed any good quality audio amplifier or the phono connections on your radio set. The many amplifiers listed elsewhere in this catalog would be excellent for this use. Cabinet is available in blonde or mahogany finish. Size: $20\frac{1}{2}$ " wide, $12\frac{1}{4}$ " high and 15 " deep. Accommodates any hi-impedance microphone.



MagneCordette complete, in mahogany.

Cat. PT6-AHXGC

MagneCordette complete, in blonde.

Cat. PT6-BAHXGC



4-hour Tape Player

A twin track playback unit that plays four hours without attention. Has automatic reverse after 2 hours in one direction. Includes line level amplifier, and is ready to attach to power amplifier equipment. Has same characteristics as the PT6-AH unit listed on Page 170. Size: 14 "x 19 " rack panel space and 9 " deep. Will also play for 8 hours if operated at $3\frac{3}{4}$ " /sec tape speed. Ideal for music distribution systems, such as in restaurants, factories, or broadcasting of long sportscasts, such as baseball, etc.

4-hour tape playback equipment complete, at $7\frac{1}{2}$ " /sec. Cat. 4-14

8-hour tape playback equipment complete, at $3\frac{3}{4}$ " /sec. Cat. 8-14

$10\frac{1}{2}$ " Reel Adaptor Kit

With this kit you can easily adapt your PT6-AH or PT63-AH recorders, listed on previous page, to handle $10\frac{1}{2}$ " reels. You then double recording capacity, or increase from 32 minutes at $7\frac{1}{2}$ " /sec to 64 minutes; or from 64 minutes at $3\frac{3}{4}$ " /sec to 128 minutes. Consists of adjustable bearings and reel arbors, 2 plastic drive belts, 2 reel adaptor hubs, and all other needed accessories and attachments for complete conversion.

$10\frac{1}{2}$ " reel adaptor kit, less reels. Cat. 93X4



Binaural Recording

The story of binaural recording is like the third dimension in motion pictures. It is, indeed, the revelation in sound. Illustrated is the binaural amplifier, which accommodates two complete recording circuits from two low level microphones. These feed a twin track recorder almost identical in appearance to the PT63-AH listed on Page 170. Both are mounted in individual leatherette covered carrying case. Records at 15 " or $7\frac{1}{2}$ " /sec. May be used with either dual groups of loudspeakers or dual headphones. 10 watt amplifier offers excellent power for most

reproducer systems. Gates will gladly prepare layouts, as well as additional information, for college, school, or auditorium installations. Binaural recording requires two input recording sources, such as microphones; and dual output, such as two loudspeakers. For this reason it cannot be used in radio broadcasting.

Binaural recording amplifier complete.

Cat. PT6-BN

Binaural recording and playback unit complete.

Cat. PT6-BAH

Tape Libraries

For both standard and binaural tape playback, a wide selection of tape recordings are available in both popular and classical orchestration. Gates will gladly supply sources for this material to those interested.

PRESTO TAPE RECORDING EQUIPMENT



Type 900-A2 Amplifier

Truly a fine tape amplifier with 3-channel mixer, consisting of two separate amplifiers on one chassis—one for recording and the other for monitoring and playback. Power supply is common to both amplifiers. VU meter is illuminated, and a switch selects its reading to: recording, playback, remote line, erase current and bias current. Three microphone inputs are 250 ohms, plus bridging input. Output 500/600 ohms at both +28 and +8 dbm. Equalizers for both speeds self-contained. Response: 50-15,000 cps. Size: 22"x7"x10½". Weight: 47 lbs.

Amplifier complete with tubes, illustrated at left above.
Cat. 900-A2

Complete recorder and amplifier package as illustrated above.
Cat. RC7-900-A2



Type RC-7 Mechanism

The name of Presto has always been synonymous with the very finest in recording equipment. The RC-7 recorder mechanism with the 900-A2 amplifier, illustrated above, is certainly no exception. Outstanding is the use of 3 motors, one constant speed for recording and two torque motors for reels. This eliminates clutches, friction breaks and tape tension. Records at 7½" and 15"/sec. Has fast forward. Response: 50-10,000 cycles at 7½". Better at 15". Uses 7" reels. Size: 16"x11¼"x14". Suggested use with 900-A2 amplifier listed to left. For 115 volts, 60 cycles. Has rugged, well styled portable case.

Recorder mechanism complete, illustrated above right unit.
Cat. RC-7

Complete recorder and amplifier package as illustrated above.
Cat. RC7-900-A2



Presto RC-7 with A-920 Amplifier

In the A-920 amplifier we have a ten watt unit with power supply, and provision for single 250 ohm microphone, plus bridging input. Two loudspeakers are self-contained behind the panel. Monitoring is direct from tape. Equalizers for both speeds. Output 10 watts at 15 ohms and +8 dbm at 500 ohms. Built-in rugged, portable case. The RC-7 mechanism, which is part of this equipment, is described above.

Amplifier only, complete with tubes. Cat. A-920

Complete recorder package consisting of RC-7 and A-920.
Cat. RC7-A920



Demagnetizer

For demagnetizing recording and playback heads. Suitable for any recorder having accessible pole pieces on heads. Operates from 115 volts, 60 cycle line.

Demagnetizer complete. Cat. DM-1

Presto RC-11 Mechanism

This is the new Presto precision tape recorder having self-contained capstan drive. Motor, fly-wheel, capstan shaft, pressure pulley, and solenoid are all pre-mounted on a cast aluminum sub-assembly. Complete push-button operation, with microswitch automatic stop in case of tape breakage. Reel capacity 10½"—which means 64 minutes at 7½"/sec tape speed. Available with automatic tape reversal, single or twin track. May be substituted for RC-7 in any models listed on this page.

Complete tape recorder, rack mount, less amplifier. Cat. RC-11

Complete tape recorder, portable—in rugged carrying case, less amplifier. Cat. RC-11P



RECORDING SUPPLIES — EICOR TAPE RECORDER



New High Output No. 120A

Description	Cat. No.
1/4" x 600' plastic reel.	120A-600
1/4" x 1200' plastic reel.	120A-1200
1/4" x 1200' plastic professional reel.	120A-1200P
Hub 1/4" x 2400' NARTB standards.	HU-1-120A
Reel 1/4" x 2400' NARTB standards.	RE-1-120A
Hub 1/4" x 4800' NARTB standards.	HU-2-120A
Reel 1/4" x 4800' NARTB standards.	RE-2-120A

Paper Base Type 101A

Description	Cat. No.
1/4" x 150' plastic reel.	101A-150
1/4" x 300' plastic reel.	101A-300
1/4" x 600' plastic reel.	101A-600
1/4" x 1200' plastic reel.	101A-1200P
1/4" x 1200' metal reel.	101A-1200M
1/4" x 2400' NARTB standard Hub.	HU-3-101A
1/4" x 2400' NARTB 10 1/2" reel.	RE-3-101A
1/4" x 4800' NARTB Hub.	HU-4-101A
1/4" x 4800' NARTB 14" reel.	RE-4-101A



Plastic Base Type 111A

Description	Cat. No.
1/4" x 150' plastic reel.	111A-150
1/4" x 300' plastic reel.	111A-300
1/4" x 600' plastic reel.	111A-600
1/4" x 1200' plastic reel.	111A-1200P
1/4" x 1200' metal reel.	111A-1200M
1/4" x 2400' NARTB standard Hub.	HU-5-111A
1/4" x 2400' NARTB std. 10 1/2" reel.	RE-5-111A
1/4" x 4800' NARTB standard Hub.	HU-6-111A
1/4" x 4800' NARTB std. 14" reel.	RE-6-111A

Plastic Base Type 111AP

1/4" x 1200' plastic professional reel. 111AP-1200

Splicing Tape

1/2" x 100" in metal dispenser.	41-100 1/2
3/4" x 100" in metal dispenser.	41-100 3/4

Leader and Timing Tape

1/4" x 150' leader tape. 43-150

Empty Reels

3" plastic reel (150 feet).	RE-3P
4" plastic reel (300 feet).	RE-4P
5" plastic reel (600 feet).	RE-5P
7" plastic reel (1200 feet).	RE-7P
7" metal reel (1200 feet).	RE-7M
10 1/2" metal reel NARTB standard.	RE-10 1/2M
14" metal reel NARTB standard.	RE-14M
Metal Hubs NARTB standard.	HU-8

Note: All of above tape, for standard tape recorders, with coating on inside. If desired with coating on outside, change all suffix letters to B (example, 120B instead of 120A, etc.). Professional reels have 2 3/4" hub. Type 111AP tape only available with coating on inside. Prices are lower as quantities increase on a per shipment basis. Any combination or variety may be ordered to obtain quantity price—see price list.

DISC RECORDING BLANKS

Audiocdisc blanks: Red label: the finest, with center and 3 drive pin holes. Yellow label: a high quality professional disc with center and 3 drive pin holes. Reference label: for making test cuts, auditions, etc. Blue label: for schools, home and demonstration work. Masters: where copies of recordings are to be made by electroplating with either gold sputtering or silvering process. Coated extra heavy, with center and one drive pin hole. All discs have aluminum base.



Description

Cat.

Red label

8" disc double face.
10" disc double face.
12" disc double face.
16" disc double face.
12" disc single face.
16" disc single face.

R-8D
R-10D
R-12D
R-16D
R-12S
R-16S

Yellow label

8" disc double face.
10" disc double face.
12" disc double face.
16" disc double face.

Y-8D
Y-10D
Y-12D
Y-16D

Reference label

10" disc double face.
12" disc double face.
16" disc double face.

RE-10D
RE-12D
RE-16D

Blue label

6 1/2" double face.
8" double face.
10" double face.

B-6 1/2D
B-8D
B-10D

Masters

12" double face.
13 1/4" double face.
17 1/4" double face.
12" single face.
13 1/4" single face.
17 1/4" single face.

M-12D
M-13 1/4D
M-17 1/4D
M-12S
M-13 1/4S
M-17 1/4S

Recording Styli

Sapphire professional, 17/32 shank 14 (87°)
Same as above, but with long shank.
Sapphire professional, 17/32 shank 14 (70°)
Same as above, but with long shank.

SY-1
SY-1L
SY-2
SY-2L

EICOR TAPE RECORDER

In many types of tape recording it is advantageous to use a low cost yet good performing equipment. This model has unusually fine performance at a cost very low for such quality. Available in single or double track. Handles 7" reels. Records at 3 3/4" or 7 1/2"/sec with built-in dual equalizer. Operates from Hi-impedance input. Has excellent response between 70-7500 cps at 7 1/2" speed. In attractive portable case with break-away power cable. Weight: 28 lbs. Size: 9 1/2" x 13" x 17 3/4".

Eicor recorder, complete for single track. Cat. 230S
Same as above, but for double track. Cat. 230D



VOLUME INDICATORS — LINE EQUALIZERS



Terminal Board Kit

Consists of the 10 pair terminal board with necessary hardware to permit termination of the input lines from the selector switch.

Terminal board kit. Cat. TER-37

VU Range Set V-22

Model V-22 volume indicator has a 10-position input switch, allowing selection of the meter to any of ten circuits. As standard, termination of inputs are made directly to switch. If terminal board desired, see MK11, listed to left. Meter is 4" illuminated. Range switch: 1 MW +4 to +40 and off. Impedance: 7500 ohms. Calibration control allows adjustment to 1/2 db accuracy. Size: 19"x5 1/4" rack space. Finish: medium gray.

VU range set complete.

Cat. V-22



Model LE-1

Fixed and Variable Equalizers

Model LE-1, at left. Operates as a parallel resonant circuit from a 600/150 ohm source. Excellent for lines about 10 miles or less. Resonant frequency 16 kc with 0.05 mfd capacitor or 20 kc with 0.025 mfd. Equalization varied by means of self-contained resistors inserted in 1 ohm steps up to 111 ohms. Inductance tuned with the 0.05 or 0.025 capacitors. Size: 2"x2 1/2"x3". Curves shown to right.

Model LE-2 variable equalizer illustrated at right consists of the LE-1 with two variable controls, inserting the resistance in 1 ohm steps up to 111 ohms. Has double jack input to accommodate standard double plug patch cord as listed on Page 145. Panel has provision for mounting an attenuator, often convenient in controlling line level. Panel size: 3 1/2"x19". Finish: medium gray.

Fixed equalizer as illustrated above left.

Cat. LE-1

Variable equalizer as illustrated above right.

Cat. LE-2



Model LE-2

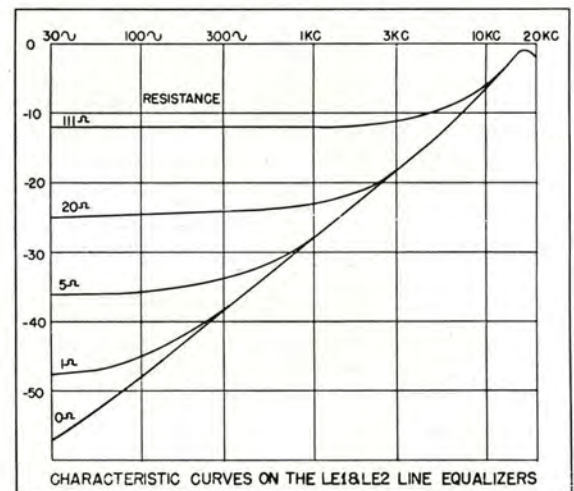

Four SA Equalizers on 19" Panel

SA Series Line Equalizers

A 20-step (1 db steps) equalizer available in 5 ranges. Designed to operate across 600 ohm line. Consists of a high-Q coil capacitively tuned. Dual frequency units have selector key for each frequency. Equalization controlled by precision rheostat. Dial indicates equalization in db which is, in all cases, variance from 1000 cycle reference. Several equalizers may be operated in parallel without affecting the other. Dial anodized in black.

Equalizer for 30 cycles only.

Cat. SA116

Equalizer for 50 and 100 cycles.

Cat. SA117

Equalizer for 4000 and 6000 cycles.

Cat. SA118

Equalizer for 8000 and 10,000 cycles.

Cat. SA119

Equalizer for 15,000 cycles only.

Cat. SA120

Panel to mount from one to four equalizers*

Cat. SA121

Panel to mount from one to five equalizers*

Cat. SA122

*Panel size: 19"x5 1/4".



SA Equalizer

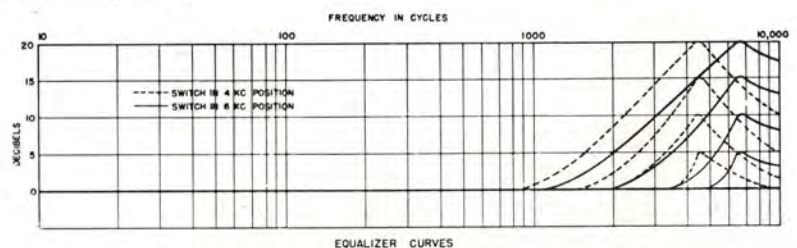

Typical curve of SA-118 equalizer for 4000 and 6000 cycles. Other frequencies are similarly covered.

SOUND EFFECTS EQUALIZERS — VOLTAGE REGULATORS

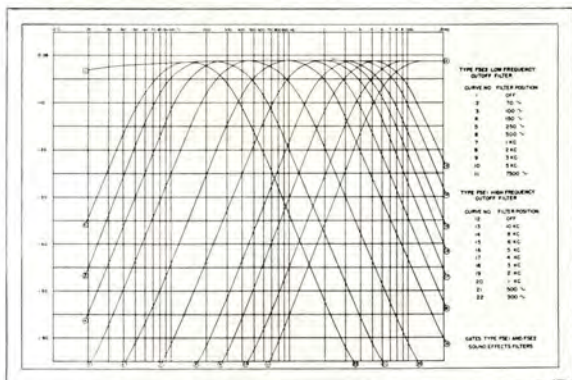

TYPE FSE SOUND EFFECTS EQUALIZERS

FSE equalizers are the ultimate in sound filters, whether in transmission, reproduction or recording. Two types are available, one for low frequencies and the other for high. Features wide frequency spectrum with overlapping cut-off frequencies, zero phase distortion, clickless steps of control, inductances toroidally wound, and complete shielding for absence of hum pickup. — It is a very flexible high and low frequency filter with independent control for each end of audio spectrum. Circuit: constant K. Insertion loss: zero. Input level: -70 to +28 dbm. Low frequency control has 10 positions of **cut-off frequencies: 70, 100, 150, 250, 500, 1000, 2000, 3000, 5000, 7500** cycles. High frequency control also has 10 positions of **cut-off frequencies: 300, 500, 1000, 2000, 3000, 4000, 5000, 6000, 8000 and 10,000 cps.** — Provided with attractive dial plate in anodized aluminum. Dial size: 3 1/8" x 3 1/4". Depth: approx. 5".

Sound effects filter complete, high frequency type. Cat. FSE-1

Sound effects filter complete, low frequency type. Cat. FSE-2

AUTOMATIC VOLTAGE REGULATORS

In this voltage regulator equipment Gates engineers have designed a unit that in no way distorts the wave form in its regulating function. The wave form is always as pure as the input wave form where the regulator is operated within the power rating specified. — Consists of two units: (a) the wall cabinet with electronic control circuits and (b) the motor driven variable auto transformer or powerstat.

The electronic control section operates from the voltage present at the output of the motor driven variable transformer section. This, in turn, is adjusted by the electronic control unit to be independent of the current consumed by the load. The same voltage will be maintained at no load as at full load. The control tube is a very sharp cut-off pentode which has a relatively large change in plate current for a small change in grid voltage. This tube, along with other circuit components and tubes, operates sensitive relays that will energize or de-energize at about 1 ma of current. These relays, in turn, operate the reversible motor attached to the variable power transformer, maintaining a constant output voltage at all times. The operator may adjust, from the front panel, the exact output voltage desired. For example, a 230 volt model can be set for 208 volts. Accuracy: -2% of output voltage. Size of control cabinet: 12" wide, 15" high, 8" deep. Variable transformer varies in size as to power rating. Below are typical sizes available. However, any size or rating can be supplied to order.



- | | |
|---|--------------------|
| Voltage regulator, 1 KVA, 115 V, 50/60 C, 1 phase. | Cat. 3954-1 |
| Voltage regulator, 2 KVA, 115 V, 50/60 C, 1 phase. | Cat. 3954-2 |
| Voltage regulator, 7 1/2 KVA, 230 V, 50/60 C, 1 phase. | Cat. 3954-3 |
| Voltage regulator, 20 KVA, 230 V, 50/60 C, 3 phase. | Cat. 3954-4 |
| Voltage regulator, 40 KVA, 230 V, 50/60 C, 3 phase. | Cat. 3954-5 |



THE FAMOUS GATES DYNAMOTE

For over 22 years Dynamote has been an important name in remote broadcasting. It has consistently fed networks and, at one time or another, nearly every radio station in the United States. — Of course, today's modern Dynamote is a far cry from the many earlier models. Of absolute certainty—today's Gates Dynamote is modern to the last minute.

SPECIFICATIONS

GAIN—88 db from microphone input to output.
NOISE—60 db below +8 dbm.
DISTORTION—1% 50-7500 cycles.
RESPONSE— $\pm 1\frac{1}{2}$ db 50-15,000 cps.
IMPEDANCES—Input for use with 50 or 250 ohm microphones. Output 600 ohms.
SIZE—18½" long, 11½" high, 11" deep at greatest depth. Panel slope: 12 degrees.
WEIGHT—31 lbs.
TUBES—One each 5879, 12AY7, 12AU7, 6X4.
BATTERIES—3 type F4PL A and 6 XX30 B.
POWER—115 V, 50/60 cycles, 35 watts.

DESCRIPTION

One-piece construction including power supply, batteries and carrying case. Features automatic changeover from power to batteries in case of power failure. This changeover is without clicks or change in level. Pilot light blinks during battery operation, indicating power failure. Three mixing channels with 20 step attenuators. Cannon XL connectors used. For other styles, see adaptors listed on next page. — Provided with 4" VU meter with dimmer control of illumination. Duplicate headphone jacks, and public address connection with PA gain control right on panel. Cue switch connects headphones on primary side of output transformer, giving voltage set-up for better phone volume. Black anodized panel, aluminum case with clip-on front cover that may be used as copy rack.

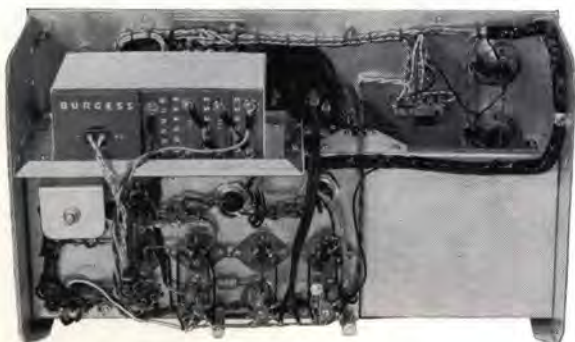

Dynamote amplifier with tubes and batteries.
Cannon microphone plugs (three required).
100% set of tubes for above.
Spare set of batteries for above.

Cat. CB-65
Cat. XL3-12
Cat. M-3811
Cat. DY-B-1

REMOTE AMPLIFIER EQUIPMENT



SA-134 Single Channel AC Powered

You will be surprised at the low price of this unit. Still, you could pay much more and obtain no better performance for a one-microphone remote equipment. Thousands in use. Built on an aluminum chassis. Has 3-stage amplifier with hi-shielded input transformer. Supplied with Cannon XL-3-12 plug. Includes headset jack, locking volume control, and fuse. Connections also available for external volume control; and starting switch in case amplifier is panel or cabinet mounted. Size: 17 $\frac{1}{4}$ " wide, 5 $\frac{1}{8}$ " deep, 5 $\frac{1}{2}$ " high. Ideal for church, news, dance bands, sports, or any single microphone pickup. For specifications see SA-136 below.

Amplifier with tubes.

Cat. SA-134

100% set of tubes for SA-134. Cat. M-3691

Gates Announco-mote

Here is a natural for single microphone remote broadcasting of sports, newscasts, and many other pickups where the amplifier may be used as a base for the microphone stand. Consists of an SA-134 amplifier, listed above, chrome plated gooseneck which has a Cannon XL-3-12 plug on one end and an Altec 600-B dynamic microphone on the opposite end. No microphone cords to break or worry about. Adjust gooseneck to fit any announcing position. For description of microphone, see page on microphones (consult Index). For amplifier specifications, see SA-136 listed below.



Announco-mote with tubes, microphone and gooseneck.
100% set of tubes for above.

Cat. ANO-134
Cat. M-3691



Two-Microphone Remote Amplifier

Embodies the SA-134 amplifier, listed on top of page, mounted in rugged steel cabinet, which houses 3" VU meter, gain control, power switch, pilot lamp, output connections, headphone jack and dual input receptacles. Switch on front selects input into choice of two microphones: one for program, one for announce. Switch, spring type, returning to MIC-1 position when released. Size: 15 $\frac{1}{2}$ " wide, 7 $\frac{1}{2}$ " high, 9 $\frac{1}{2}$ " greatest depth. Panel slope: 15 degrees. Finish: medium gray. Operates from 115 volts, 50/60 cycles.

Specifications

TUBES—One each 6J7, 6SJ7, 6SN7, 6X5.
IMPEDANCES—Input 50 or 250 ohms.
Output 600 ohms.

GAIN—82 db.

RESPONSE— ± 1.5 db 50-15,000 cycles.

DISTORTION—1.5% or less at +10 dbm.

NOISE—65 db below -10 dbm measured at -60 dbm input.

Two microphone remote amplifier with tubes.

Cat. SA-136

Microphone connectors (2 required).

Cat. XL-3-12

100% set of tubes for above.

Cat. M-3691



Microphone Adaptors

All Gates remote amplifiers are supplied with Cannon XL connectors. To accommodate others, these adaptor cables are available. Usually left as part of microphone cable when not in use. Cords are 6" long.

From XL connector to Amphenol receptacle. Cat. M-3782

From XL connector to Cannon P3-CG-11 receptacle. Cat. M-3781

From XL connector to Hubbell 7559 receptacle. Cat. M-3780



Remote Control Equipment

(For Unattended Operation)

Broadcasting stations up to 10,000 watts power, that operate without directional antenna, may elect to operate the transmitting equipment unattended, by the installation of proper apparatus that allows full control and visual indication of the transmitter's major functions. These functions are defined by the FCC as methods of turning the transmitter on and off, reading current or voltages of major meters, an adjustable power control, a tower light indication, remote reading of frequency monitor, and remote reading of modulation monitor.

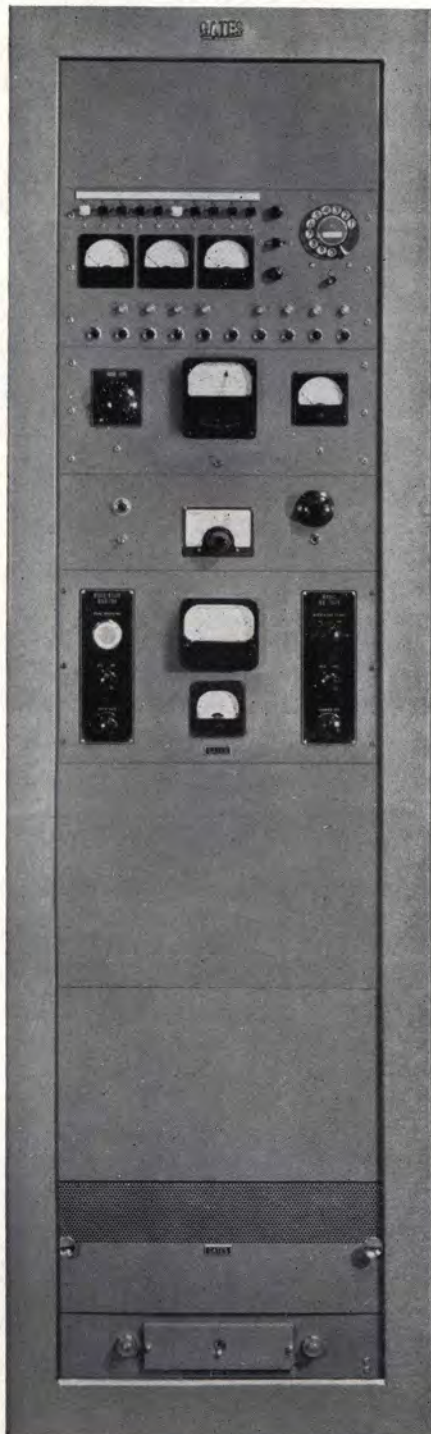

Left, the studio installation. Rack size 78" high, 23 $\frac{3}{4}$ " wide and 20 $\frac{1}{2}$ " deep. This is the complete remote equipment at the studios, embodying simplicity with completeness.

Right, the transmitter installation — a waist-high rack cabinet that fits under a window sill, if desired. Where space in the transmitter building is at a premium, this feature is important.



REMOTE CONTROL FOR UNATTENDED OPERATION

System RCM-12 is designed for use with Gates MO-2890 frequency monitor and is complete with extension meters, leaving the frequency monitor intact at the transmitter. This type is illustrated in the larger cabinet. The modulation monitor is shown for illustrative purposes only, and may be either Gates or General Radio. A radio frequency amplifier is supplied to operate the modulation monitor from the air signal.

System RCM-14 is the same as RCM-12, except for the General Radio frequency monitor. The GR monitor is moved to the remote location,

and obtains its pickup from a simple inverted L receiving antenna located on top of the studio building. In this case, the remote meter panel for the frequency monitor is not required because the entire monitor is moved to the studios. Proper blank panel space is provided for the GR monitor.

Size of studio cabinet is 78" high, 23 $\frac{3}{4}$ " wide and 20 $\frac{1}{2}$ " deep. Transmitter cabinet is waist-high style and may be placed under a window ledge, using a minimum of space. Size: 37 $\frac{3}{4}$ " high, 23 $\frac{7}{8}$ " wide and 23" deep. Both are finished in medium gloss gray.

SPECIFICATIONS AND EQUIPMENT SUPPLIED

1. Housed in two rack cabinets (one at transmitter, one at studio).
2. Rack at studio contains:
 - a. Remote meters (with calibration facilities).
 - b. Dial meter selector (with step relay).
 - c. Frequency meter:
 - (1) Meter and audio amplifier for Gates monitor—RCM-12 only.
 - (2) Entire monitor, if General Radio (existing monitor may be used).
 - d. Control oscillators and amplifier.
 - e. Control oscillator selector switching.
 - f. Modulation monitor (existing monitor may be used).
 - g. RF amplifier for modulation monitor.
 - h. Power-supplies:
 - (1) PWR3 regulated supply.
 - (2) PWR11 6 volt DC supply.
 - (3) 75 volt DC supply.
3. Rack at transmitter contains:
 - a. Step relay for metering selection.
 - b. Selective control amplifiers.
 - c. Transmitter control relays.
 - d. Power supplies:
 - (1) PWR3 regulated supply.
 - (2) PWR11 6 volt DC supply.
4. Meter pickup kits (supplied):
 - a. Transmitter high voltage (resistive network).
 - b. Transmitter plate current (resistive network).
 - c. Antenna current (diode unit).
 - d. Tower lights (transformer-rectifier-filter unit).
 - e. Frequency pickup (resistive network).
5. Lines (two required):
 - a. One line for metering voltages.
 - b. One line for:
 - (1) Meter selection circuit.
 - (2) Control circuit.
 - (3) Phone circuit.
6. Other equipment supplied:
 - a. Motor tuning for plate rheostat.
7. All equipment is for 115 volts, 60 cycle operation. Due to completeness of instruction book and design, we believe installation service is not required. This service is available, however, at additional cost.

Complete two cabinet system, with tubes, for Gates frequency monitor. Cat. RCM-12

Same as above, but for General Radio 1181A frequency monitor.

Cat. RCM-14

SOUND EQUIPMENT BY STROMBERG CARLSON



Two Inputs—Six Watts

A fine, low cost unit with microphone and phono inputs and treble control. May be used for many moderate PA requirements, or driving amplifier for higher power system. Cover illustrated is an accessory.

SPECIFICATIONS

SIZE WITH COVER—11" wide, 6" deep, 9½" high. Allow 1" front for knobs and 2" back and side for connectors.
 WEIGHT—Net 8 lbs., packed for shipment 9¾ lbs.
 TUBES SUPPLIED—Two 6SJ7, one 6L6G, one 5Y3G.
 POWER SUPPLY—105-125 volts, 50-60 cycles, 75 watts at 117 volts.
 INPUTS—One microphone, one phonograph, both high impedance.
 CONTROLS—One microphone, one phonograph, one treble control with off-on switch.
 POWER OUTPUT—6 watts, less than 5% harmonic content.
 GAIN—103 db from microphone input based on 40,000 ohm source, 64 db from phonograph input based on 100,000 ohm source.
 OUTPUT IMPEDANCE TAPS—4, 8 and 15 ohms.
 FREQUENCY RESPONSE—75 to 8,500 cycles within +0 db -3 db.
 FINISH—Glacier gray over copper plate.

Amplifier with tubes, less cover.
Cover for above.

Cat. AU-29
Cat. AC-29



Two Inputs—Fifteen Watts

Very similar to AU-29 listed at left, having microphone and phono input, treble control, and excellent for many PA and sound distribution requirements. A quality unit in the low price field. Cover is included in this model.

SPECIFICATIONS

SIZE WITH COVER—13½" wide, 7½" deep, 10¼" high. Allow 1" front for knobs and 2" back and side for connectors.
 TUBES SUPPLIED—One 6SF5, one 6J5 or 6C5, one 6SC7, two 6L6G, one 5Y3GT/G.
 POWER SUPPLY—105-125 volts, 50-60 cycles, 90 watts at 117 volts.
 INPUTS—One microphone, one phonograph, both high impedance.
 CONTROLS—One microphone, one phonograph, one treble control with off-on switch.
 POWER OUTPUT—15 watts, less than 5% harmonic content.
 GAIN—111 db from microphone input based on 40,000 ohm source, 61 db from phonograph input based on 100,000 ohm source.
 OUTPUT IMPEDANCE TAPS—4, 8, 15 and 500 ohms.
 FREQUENCY RESPONSE—75 to 10,000 cycles within +0 db -3 db.
 FINISH—Glacier gray over copper plate.

Amplifier with tubes.

Cat. AU-42



Two Inputs—Twenty-five Watts

Identical to AU-29 listed above, except that power output is 25 watts. This amplifier will operate a number of speakers with wide coverage, and will provide excellent music quality.

SPECIFICATIONS

SIZE—13½" wide, 9" deep, 9" high. Allow 1" front for knobs, 2" side and back for connectors.
 WEIGHT—Net 20 lbs., packed for shipment 22½ lbs.
 TUBES SUPPLIED—One 6SJ7, one 6SF5, one 6N7, two 6L6G, one 5U4G.
 INPUTS—One microphone, one phonograph, both high impedance.
 CONTROLS—One microphone, one phonograph, one treble control with on-off switch.
 POWER SUPPLY—105-125 volts, 50-60 cycles, 125 watts at 117 volts.
 POWER OUTPUT—25 watts, less than 5% harmonic content.
 GAIN—109 db from microphone input based on 40,000 ohm source, 72 db from phonograph input based on 100,000 ohm source.
 OUTPUT IMPEDANCE TAPS—4, 8, 15, 250 and 500 ohms.
 FREQUENCY RESPONSE—50 to 10,000 cycles within +1 db -2 db.
 FINISH—Glacier gray over copper plate.

Amplifier with tubes, cover included. Cat. AU-34



Two Inputs—Fifty Watts

Has treble and bass controls. Microphone and phono inputs. You can tie output of two of these amplifiers together to obtain 100 watts power with two microphones and two phono inputs.

SPECIFICATIONS

SIZE—16" wide, 12" deep, 11" high. Allow 1" front for knobs and 2" back and side for connectors.
 WEIGHT—Net 35 lbs., packed for shipment 44 lbs.
 TUBES SUPPLIED—One 6SJ7, one 6SC7, one 6N7, four 6L6G, two 5U4G.
 INPUTS—One microphone, one phonograph, both high impedance.
 CONTROLS—One microphone, one phonograph, one bass, one treble, one on-off power switch.
 POWER SUPPLY—105-125 volts, 50-60 cycles, 245 watts at 117 volts.
 POWER OUTPUT—50 watts, less than 5% harmonic content.
 GAIN—117 db from microphone input based on 40,000 ohm source, 85 db from phonograph input based on 100,000 ohm source.
 OUTPUT IMPEDANCE TAPS—4, 8, 15, 250 and 500 ohms.
 FREQUENCY RESPONSE—50 to 12,000 cycles within +0 db -3 db.
 FINISH—Glacier gray over copper plate.

Amplifier with tubes, cover included. Cat. AU-36



Bridging Fifty Watt Amplifier

Description

You can bridge 1 or 20 of these amplifiers across a 600 ohm line. Note excellent response. Full 50 watts output at low distortion. Has calibrated bass control to reduce bass in reverberant conditions. Cover is an accessory. — This is a quality amplifier that may be used where the finest in sound distribution up to 1000 watts (20 units) is desired.

Amplifier with tubes, less cover. Cat. AP-50
Cover for above. Cat. AC-50

Specification

SIZE—8" wide, 14" deep.
 SHIPPING WEIGHT—42 lbs.
 TUBES—6SN7GT, 6N7, two 5U4G, four 6L6G.
 POWER—105-125 volts, 50-60 cycles; 220 watts.
 GAIN—44 db across 600 ohms.
 INPUT—30,000 ohms at 1000 cps.
 OUTPUT POWER—50 watts, less than 5% distortion.
 OUTPUT IMPEDANCES—8, 16, 32 ohms.
 NOISE—70 db below rated output.
 CONTROLS—Start switch, gain, bass control, pilot lamp.
 FINISH—Glacier gray.

SOUND EQUIPMENT BY STROMBERG CARLSON



25 Watt Two Speaker Portable

Incorporates the AU-33 amplifier shown at right, below. Two 12" speakers with 25 ft. cords operate from this 25 watt amplifier, with inputs for 3 microphones and one phonograph. Size: 20 1/4" high, 17 3/4" wide and 13 3/4" deep. Weight: 49 lbs. Case in durable Fabrikoid. Ideal for dance bands, clubs, schools and wherever a fine portable system is required. Microphones are not included.

25 watt portable system, with tubes. Cat. PS-33



15 Watt Two Speaker Portable

This model employs the AU-32 amplifier shown at left, below. Two 8" speakers attached to 25 ft. cables, and mounted on the large dissecting case, supplies excellent baffle area for top quality. Two microphones and one phonograph may be accommodated. Size: 17 1/2" high, 16 3/4" wide, 11 3/4" deep. Weight: 38 1/2 lbs. Finish: gray Fabrikoid. Ideal for areas up to 350,000 cu. ft. Microphone not included.

15 watt portable system, with tubes. Cat. PS-32



15 Watts—Three Inputs

For social halls, restaurants, service clubs, or anywhere that a high quality multi-input PA system is required, the AU-32 amplifier is ideal. Features treble control.

SPECIFICATIONS

SIZE WITH COVER—13 1/2" wide, 7 1/2" deep, 10 1/4" high. Allow 1" front for knobs and 2" back and side for connectors.
 WEIGHT—Net 19 lbs., packed for shipment 22.5 lbs.
 TUBES SUPPLIED—One 6J5, two 6SC7, two 6L6G, one 5Y3G.
 INPUTS—Two microphone, one phonograph, all high impedance.
 CONTROLS—Two microphone, one phonograph, one treble attenuator with off-on switch.
 POWER SUPPLY—105-125 volts, 50-60 cycles. 90 watts at 117 volts.
 POWER OUTPUT—15 watts, less than 5% harmonic content.
 GAIN—105 db from microphone input based on 40,000 ohm source, 75 db from phonograph input based on 100,000 ohm source.
 OUTPUT IMPEDANCE TAPS—4, 8, 15 and 500 ohms.
 FREQUENCY RESPONSE—75 to 10,000 cycles within +0 db -3 db.
 FINISH—Glacier gray over copper plate.

Amplifier complete with tubes.

Cat. AU-32



25 Watts—Four Inputs

Three microphones and one phonograph input, separate bass and treble controls, and 25 watts output fits this amplifier into a wide variety of uses.

SPECIFICATIONS

OVER-ALL SIZE—13 1/2" wide, 9" deep, 10 1/2" high. Allow 1" front for knobs and 2" back and side for connectors.
 WEIGHT—Net 25 lbs., packed for shipment 28 3/4 lbs.
 TUBES SUPPLIED—Three 6SJ7, one 6SF5, one 6N7, two 6L6G, one 5U4G.
 INPUTS—Three microphones, one phonograph, all high impedance.
 CONTROLS—Three microphones, one phonograph, one bass, one treble, and one on-off switch.
 POWER SUPPLY—105-125 volts, 50-60 cycles. 130 watts at 117 volts.
 POWER OUTPUT—25 watts, less than 5% harmonic content.
 GAIN—108 db from microphone input based on 40,000 ohm source, 71 db from phonograph input based on 100,000 ohm source.
 OUTPUT IMPEDANCE TAPS—4, 8, 15, 250 and 500 ohms.
 FREQUENCY RESPONSE—50 to 10,000 cycles within +1 db -2 db.
 FINISH—Glacier gray over copper plate.

Amplifier complete with tubes.

Cat. AU-33



Four Inputs—Two 25 Watt Outputs

This is a 50 watt amplifier; but the output is divided by 2 gain controls, allowing use of 2 groups of speakers at varied levels. You can rate it at either 50 watts, or 2 banks of speakers at 25 watts each. Has 3 microphones and 1 phonograph input hi-impedance; bass and treble controls; output impedances, 4, 8, 15, 250 and 500 ohms. Response: 50-12,000 cycles within 3 db. Size: 16" wide, 12" deep and 11" high. Tubes: three 6SJ7, three 6SC7, two 6N7, four 6L6G, two 5U4G. Shipping weight: 50 lbs.

Complete amplifier with tubes.

Cat. AU-35

FOR MICROPHONES
See Pages 184 and 185

FOR LOUDSPEAKERS
See Pages 182 and 183

LOUDSPEAKERS AND CABINETS



Radax Super 12" Full Range Coaxial Speaker

The Radax principle divides musical spectrum between two reproducing media. Low frequency driver produces bass tones below 4000 cps. A high frequency propagator handles upper range by a built-in mechanical crossover. Design greatly reduces intermodulation and transient distortion. Standard RTMA mounting. Rating 25 watts, 35-14,000 cps. Impedance 8 ohms. 12 1/8" diameter, 7 1/2" deep. Wt. 25 lbs. Aristocrat enclosure, below, is suggested.

Super 12" coaxial speaker. Cat. SP12

Aristocrat Enclosure

Klipsch principle employs corner of room as extension of exponential acoustic-horn air load. This allows the addition of at least one full octave of bass range. Its efficiency is several times greater than that of conventional bass reflex or vented cabinets. Size 29 1/2" high, 19" wide, 16 1/2" deep. Wt. 35 lbs. Beautiful, hand rubbed, mirror finish.

Aristocrat enclosure, finish blonde.

Cat. EV-AR12B

Aristocrat enclosure, finish mahogany.

Cat. EV-AR12M

Extended Range 12" Speaker

Very similar to SP12 at left, but maximum rating 18 watts. Response 35-13,000 cps. Impedance 8 ohms. Diameter 12 3/8", depth 6 3/8". Weight 9 lbs. Mechanical crossover is at sixth octave and reproducing load is proportionately distributed between two individual cones. Aristocrat enclosure, listed left below, is recommended for this speaker.

Extended range 12" coaxial speaker. Cat. SP12B

Radax 8" Full Range Coaxial Speaker

The high efficiency of the Radax system allows the use of smaller speakers with marvelous results. This 8" speaker is among the best. Two cones, mechanical crossover, very low intermodulation and transient distortion. Roll off above 9000 cycles allows full brilliance and, yet, eliminates ordinary noises of record and line noise. The Baronet enclosure is ideal with this speaker.

Radax 8" coaxial speaker. Cat. SP8B



Stephens Coaxial Speaker

A 15" low resonant cone speaker, combined with a separate 8 cell horn driven by a light weight metal diaphragm and voice coil assembly. Has 1200 cycle high pass filter. Power 20 watts. Response 40-20,000 cps. Diameter 15 1/8". Impedance 500 ohms.

Stephens Coaxial Speaker. Cat. 5106AX



Baronet Enclosure

Very similar to the Aristocrat, but designed for 8" loudspeaker. When placed in a corner of an ordinary room, response down to fundamental 30 cycle tone is possible. Size: 22 1/4" high, 14 1/2" wide, 14 3/4" deep. Weight 18 lbs.

Baronet enclosure, finish blonde.

Cat. EV-AR8B

Baronet enclosure, finish mahogany.

Cat. EV-AR8M



Stephens Co-Spiral Speaker

This 15" co-spiral full range speaker, of the single voice coil type, has a 4 lb. Alnico V permanent magnet. Definitely a first class speaker for the very best in sound reproduction up to 14,000 cycles. High efficiency and wattage. Size: 15 1/8" diameter, 8 1/2" deep. Wt. 12 lbs.

Co-Spiral 15" Speaker, 12 ohms. Cat. 102FR

Co-Spiral Speaker, 500 ohms. Cat. 5102FR



Tru Sonic Silver Cabinet

May be used with either 12" or 15" loudspeakers of all types. Construction — hard plywood, beautifully finished in silver hammertone. 6 cu. ft. area. 42 cycle low response. Has wine colored plastic grill. Size: 32" high, 23 3/4" wide, 16 1/2" deep.

Tru Sonic Cabinet for 12" speaker. Cat. 528-12

Tru Sonic Cabinet for 15" speaker. Cat. 528-15

Surface Mount Ceiling Baffles

A well built baffle of heavy gg aluminum. Has excellent baffle area to provide good tone quality. Louvers at 90 degrees supply pressure relief. Sizes: 6" is 12 1/4" diameter, 7 1/4" deep; 8" is 14 3/4" diameter, 8" deep; 10" and 12" are 18 3/8" diameter and 9 1/4" deep.

Surface Ceiling Baffle for 6" speaker.

Surface Ceiling Baffle for 8" speaker.

Surface Ceiling Baffle for 10" speaker.

Surface Ceiling Baffle for 12" speaker.

Cat. BL6-A

Cat. BL8-A

Cat. BL10-A

Cat. BL12-A



Flush Mount Ceiling Baffles



Small, compact, inexpensive baffle for flush mounting a speaker. Total diameter 10 3/4" for 6" speaker, 12 1/4" for 8" and 16 1/2" for 10" or 12" speakers. Made and finished in aluminum. May be painted to match room colors.

Ceiling Baffle for 6" speakers. Cat. AL6-A

Ceiling Baffle for 8" speakers. Cat. AL8-A

Ceiling Baffle for 10" or 12" speakers. Cat. AL10-A



Flush Wall Mount Baffles

Made of spun metal 18 gg aluminum, and may be used with PR or CP plaster rings listed on this page. Grill, flocked metal colored cloth. 6" size, 10" diameter; 8" is 12 3/8"; 10" and 12" is 16 1/2" diameter.

Wall Baffle for 6" speaker. Cat. RS6-A

Wall Baffle for 8" speaker. Cat. RS8-A

Wall Baffle for 10" speaker. Cat. RS10-A

Wall Baffle for 12" speaker. Cat. RS12-A



Back Cover Speaker Can and Plaster Ring Assembly

This style mounting is suggested only for new construction or complete remodeling. Has 3/4" knockouts. Prevents dust or mortar from getting in cone speaker. May be used with all RS and AL style baffles.

For AL6 or RS6 Baffles. Cat. XCP6

For AL8 or RS8 Baffles. Cat. XCP8

For AL10, RS10 and RS12 Baffles. Cat. XCP10

Cat. XCP6

Cat. XCP8

Cat. XCP10



WALL SPEAKER CABINETS

Illustrated above are three popular size wall mount cabinets for studio and reception room use. Have air release on side and will produce unusually fine results. Finished in walnut.

Illus.	Type	Speaker Size	Height	Width	Depth
A	M6	6"	8"	7 1/4"	4 3/4"
B	M8	8"	11"	10 1/2"	6 1/2"
C	M12	10" & 12"	16 1/2"	14 3/8"	8 1/2"

LOUDSPEAKERS, CABINETS, MATCHING TRANSFORMERS



CONE LOUDSPEAKERS AND MATCHING TRANSFORMERS

All manufactured by Jensen in varying models as shown below, from 4" to 15" in size. Manufactured to RMA standards.

Illus.	Type	Size	V. C. Imped.	Watts	Suggested Xformer
C	P-4X	4"	3-4 ohms	2.0	Z-3300, ZL-2021
C	P-6X	6"	3-4 ohms	3.0	ZL-2021
D	P-8T	8"	3-4 ohms	7.0	ZY-4004
D	P-10T	10"	6-8 ohms	8.0	ZY-2002
D	P-10Q	10"	8 ohms	12.0	ZY-2003
E	P-12T	12"	6-8 ohms	9.0	ZY-2002
E	P-12Q	12"	8 ohms	14.0	ZY-2003
E	P-15Q	15"	8 ohms	16.0	ZY-2003

SPEAKER MATCHING TRANSFORMERS

Illus.	Type	V. C. Imped.	Line Imped.	Watts	For Use With
A	Z-3300	3-4 ohms	500 ohms	3.5	P4X
A	ZL-2021	3-4 ohms	500-1000-1500-2000	6.5	P4X, P6X
B	ZY-4004	3-4 ohms	500-1000-1500-2000	10.0	P8T
B	ZY-2002	6-8 ohms	500-1000-1500-2000	10.0	P10T, P12T
B	ZY-2003	6-8 ohms	500-1000-1500-2000	16.0	P10Q, P12Q, P15Q, JRP-40
B	Z-3423	16 ohms	500 ohms	25.0	HNP-51



Type B Utility Cabinet

Full bass reflex acoustic design is offered in this low cost cabinet. Size: 23½" high, 23¾" wide, 11⅞" deep. Finish brown hammer lacquer, with brown flocked grill screen. Available for 12" speakers only.

Utility cabinet, shipping wt. 34 lbs. Cat. B-121



Type C Bass Reflex Cabinets

Marvelously styled and low in cost. Available in blonde or mahogany. Bass reflex concealed under matching grill cloth. C151 has concealed cut-outs for 15" coaxial and triaxial speakers where used with flush level and h-f controls.

Type C cabinet, 8" speaker, 23½" high, 20" wide, 9" deep, in blonde. Cat. C81-ST864
Same as above in mahogany. Cat. C81-ST865
Type C cabinet, 12" speaker, 29" high, 25" wide, 13½" deep, in blonde. Cat. C121-ST866
Same as above in mahogany. Cat. C121-ST867
Type C cabinet, 15" speaker, 32" high, 28" wide, 15" deep, in blonde. Cat. C151-ST868
Same as above in mahogany. Cat. C151-ST869



Model D Imperial Cabinets

Truly fine furniture styling. These well known Jensen cabinets combine good acoustic performance and beauty. Selected satin finish veneered walnut with interlaced bronze strip grill. Cut-outs on back for level and h-f controls where used with coaxial or triaxial speakers.

Model D cabinet, 12" speaker, 31" high, 27¾" wide, 13¾" deep. Cat. D121-ST156
Model D cabinet, 15" speaker, same dimensions as above. Cat. D151-ST157



Triaxial Speaker

Perhaps the finest loudspeaker ever manufactured. Consists of low, medium and high frequency units, all 3 sections combined in one unit. Crossover and control network, illustrated at right, comes with speaker. Features response uniform to the ear and beyond hearing limits—to 20,000 cycles. Low response to 30 cycles. Size: 15½" diameter and 10¾" deep. Power rating 35 watts. May be used with any cabinets listed on this page for 15" speakers. Impedance 16 ohms.

Triaxial speaker complete with crossover and control network. Transformer to operate triaxial speaker from 500 ohm line

Cat. G610-ST900
 Cat. T202



Crossover Network



Type T Impedance Transformer



A110 Control Network



Type K Coaxial Speaker

Coaxial Speakers

Jensen K510—Among the very best. Features wide angle acoustic lens. Alnico 5 PM magnetic structure. Impedance 16 ohms. Rating 25 watts. Size: 15½" diam., 9½" deep. May be used with control network and impedance transformer.

Jensen Coaxial Speaker, 15". Cat. K510

Jensen K410—For broadcasting, monitoring, and professional use, this high quality coaxial speaker comes with integral frequency division system. Alnico 5 PM field. May be used with control network or impedance transformer, as desired. Impedance 16 ohms. Rating 20 watts. Size: 15½" O. D., 9" deep. Only surpassed by model K510, above.

Jensen Coaxial Speaker, 15". Cat. K410

Jensen K310—This is the lowest priced 15" coaxial speaker. Has diaphragm radiator and new piston type h-f unit. Alnico 5 PM structure. Size: 15½" O. D., 8½" deep. Impedance 16 ohms. Rating 16 watts. May be used with control network or impedance transformer.

Jensen Coaxial Speaker, 15". Cat. K310

Jensen K210—A truly fine 12" coaxial speaker and modest in price. In fact, the price is attractive enough to allow its use in place of ordinary single cone units. Impedance 8 ohms. Power rating 12 watts. Size: 12½" O. D., 6¼" deep. Use ZY2003 matching transformer listed above, if needed.

Coaxial Speaker, 12" Cat. K210

Control Network—Illustrated at top of page, may be used with H510, K410, K310 speakers. Mounts on speaker housing. 30" cables extend to flush mount controls. May be used with impedance transformer. Impedance 16 ohms. Includes level and high frequency controls.

Control Network. Cat. A-110-ST832

Impedance Transformer—For H510, K410, K310 speakers. T102 to match 500 or 250 ohms. T103, 10,000 and 5000 ohms center tapped.

Impedance transformer, 500-250 ohms. Cat. T102
Impedance transformer, 10,000-5000 ohms. Cat. T103



Reproducer Cabinet Type M

For tone and styling this cabinet is outstanding, and will grace the finest surroundings. May be placed on side, as illustrated, or on end. Services entirely from front by removal of front section. Size: 36"x24"x18" deep. Legs illustrated are an accessory, as some installations do not require legs. Weight 80 lbs.

Type M cabinet, finish blonde.

Cat. M-ST-838

Same as above, but finish Cordovan.

Cat. M-ST-858

X stretcher leg assembly, 8" above floor, blonde.

Cat. ST-843

Same as above, but finish Cordovan.

Cat. ST-863

Level Controls—An L pad control for use in adjusting speaker volume in low impedance circuits. Complete with knob and dial.

Control, 6-8 ohms, 5 watts. Cat. ST-276

Control, 3-4 ohms, 5 watts. Cat. ST-760

Control, 500 ohms, 15 watts. Cat. ST-761

Control, 6-8 ohms, 15 watts. Cat. ST-411

High Frequency Control—Simplified system of fidelity control for coaxial speaker. Adjusts level of high frequency portion of coaxial reproducer. Rating 15 watts. Impedance 16 ohms. Complete with knob and dial.

High frequency control. Cat. ST-606

Coaxial Level Control—A 500 ohm L-pad for use in the input of 15" coaxial speakers. With satin finish brass cup escutcheon and bar knob. Level control for coaxial speakers. Cat. ST-783

Range Control Switch—A 4-position selector switch, operating in the h-f range, to adjust speaker performance to any program material. With satin finish brass cup escutcheon and bar knob.

Range switch. Cat. ST-784

MICROPHONES

Telefunken Condenser Microphone

Where quality is paramount, this microphone is considered by many engineers as the very finest available today. A condenser microphone with extremely wide frequency range and very low distortion. Switch selects between omnidirectional and very directional pattern. Output level -56 db. Size, overall, 9 $\frac{3}{8}$ " high, 2 $\frac{3}{8}$ " diameter. Weight 1 $\frac{1}{2}$ lbs. Output impedance, 50 or 200 ohms. Uses a single VF14 tube. Provided with 30' cable and plugs. Power supply, illustrated at right, is a necessary accessory. Made in Germany. Repairs and service parts handled in the United States.



Telefunken microphone with cable and tube.
Power supply for above.

Cat. U47M
Cat. U47N



Ribbon and Dynamic Cardioid



A beautiful microphone with 50-3000 cps response and good output level of -53 db. True cardioid polar pattern. Transformer allows 3 impedances of 50, 250 or Hi-Z. 25 ft. cable. $\frac{5}{8}$ -27 thread on combination swivel and side lock. 6" high, 2" diameter.

American microphone less stand.
Cat. DR332

Desk stand for above as illus. Cat. ND

Shure Cardioid

Most used cardioid microphone on the market today. Shock mounted. Impedance selector for 50, 150 and Hi-Z. 40-15,000 cps response on front. Dead on rear. $\frac{5}{8}$ -27 thread. 20 ft. cable. Case size: 3 $\frac{1}{4}$ " high, 2 $\frac{1}{4}$ " wide.

Cardioid microphone with cable.

Cat. 556S



Velocity Microphones (By Shure)

These two new microphones are best described as having a new, slender design and a new high in velocity microphone performance. Model 300 has 40-15,000 cps peak free response. Model 315 responds from 50-12,000 cps. A natural for TV, or the best in radio and recording. Glare-free finish. Bi-directional. Output level about -59 db. Approximately 9" high, 1 $\frac{1}{2}$ " wide, 1 $\frac{1}{4}$ " deep. Selector switch to 50, 150 or Hi-Z. 20' cable.

Deluxe Velocity. Cat. 300
Standard Velocity. Cat. 315



Dynamic Omnidirectional

Omnidirectional, slim, modern styling, 40-15,000 cycle response, and high output are all features of this new American product. Output 50 or 250 ohms. Thread $\frac{5}{8}$ -27. Adjusts to any angle. 25 ft. cable. Size: 8 $\frac{1}{4}$ " high, 1" diameter. Desk stand an accessory.

American microphone, less stand. Cat. D33

Desk stand as illustrated. Cat. ND



Velocity Microphones

Electro-Voice has made velocity microphones for a long time. Modest in price and available in 2 quality ranges. V2A 40-10,000 cycles peak free. V1A 40-9000 cycles. V2A output -53 db and V1A -63 db. Impedance 250 ohms. 18 ft. cable supplied. $\frac{5}{8}$ -27 thread. Internal shock absorber.



Velocity microphone, 40-10,000 cycles. Cat. V2A
Velocity microphone, 40-9000 cycles. Cat. V1A

Altec 660

Modeled after the famous W. E. 633 saltshaker. 40-10,000 cycle performance. -57 db output. $\frac{5}{8}$ -27 thread. 4" high, 1 $\frac{3}{4}$ " diameter.

Swivel included. No cable supplied.
For 30 ohms output. Cat. 660A
For 30, 150, Hi-Z output. Cat. 660B



Lavalier



Unique complete microphone and kit. Hand, desk, or cord around neck. Omnidirectional -55 db output 60-13,000 cycle response. Impedance 150 ohms. 18 ft. cable. Microphone 4"x1". Stand 2 $\frac{3}{4}$ " base. Made by Electro-Voice.
Lavalier microphone with accessories as illustrated. Cat. 647

635 Dynamic



Most popular in remote pickups; but, also excellent for announcing and studio.
A truly fine, low priced, dynamic microphone. 60-13,000 cycle response, -55 db output. Impedance selector for 50 or 250 ohms. $\frac{5}{8}$ -27 thread. 18 ft. cable.

Dynamic microphone with swivel. Cat. 635

Microphone Impedances

New standards employ 150 ohm mixing circuits. To avoid confusion, any 150 ohm microphone will operate excellently into a 250 ohm mixer. In many instances microphones operate best into an unloaded input.

Slim Trim Dynamics

These microphones vary chiefly in response breadth. Type 655 in very high quality field with 40-15,000 cycle response, -51 db output and low distortion. Size: 11 $\frac{3}{8}$ " high, 1" diameter. Model 654 has 50-13,000 cycle response, -55 db output. Size: 10" high, 1" diameter. Both have pop-proof heads and acoustalloy diaphragms. 18 foot cables.



Slim Trim Deluxe Dynamic microphone. Cat. 655
Slim Trim Standard Dynamic microphone. Cat. 654

MICROPHONE STANDS, CALL LETTER PLATES, WIRE

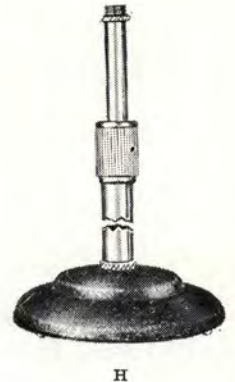
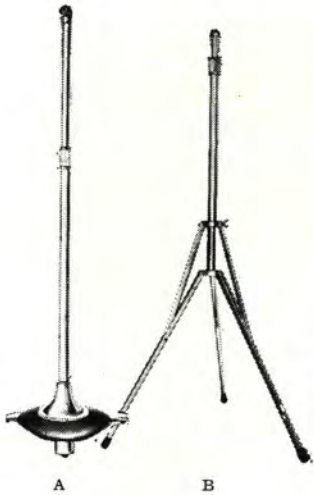

I



J

Description

Figure	Item	Wt. lbs.	Tube Finish	Height Adjust.	Base Diam.	Cat. No.
A	Studio floor stand.	24	chrome	42"-72"	17"	MS-25
B	Collapsible floor stand.	5	chrome	42"-72"	folds	CS-1
C	Sky hook to attach microphone to beam, another microphone stand etc.	—	chrome	—	—	SK-1
D	Boom stand with 63" horizontal boom.	35	chrome	42"-72"	17"	BS-36
E	Bracket clamp.	—	chrome	6"	—	BC-1
F	Snap-on microphone attachment to snap microphone to stand.	—	chrome	—	—	SO-1
G	Banquet stand.	5	chrome	18"-32"	8"	TS-6
H	Desk stand.	3	chrome	8"-13"	6"	DS-7
I	Rear exit desk stand.	3	enamel and chrome	3"	7"	DS-10
J	Duplex microphone mount with copy stand.	7	plastic and chrome	copy stand is 9"x11"	—	TB-1

Note—All stands have 5/8"-27 threads. Models MS-25 and BS-36 have "Safety air lock cushion" to prevent tube from banging down during adjustment. All adjustable models have full grip clutch, inner-lined with wear proof bakelite locking collet. All stands have base pads to prevent scratching desk or polished floor.



SHIELDED AUDIO WIRE

Standard Size—2C No. 20 stranded, cloth and heavy cotton fabric with tinned copper shielding. Finest quality, and standard in the industry.

Per 1000 ft. **Cat. SH-2-20**

Small Size—A very small 2C No. 24 stranded with vinyl insulation and tinned copper shielding. O. D. only 0.115". Very good for rack wiring, etc.

Per 1000 ft. **Cat. 1261**

Microphone Cable

Rubber jacket, 2C No. 20. Each conductor cloth and cotton covered, tinned copper shielding, and rubber jacket. Very flexible. Per 100 ft. **Cat. MIC-100**



CALL LETTER PLATES

Available in many sizes and styles shown above. White letters with black background. If black letters and white background desired, cost slightly higher.

Model	For Make of Microphone or Stand	Figure	Code
A125	Western Electric 618 Series.	E	ZEJDO
A118A	Western Electric 633 Series.	B, D	ZEJEB
A110	Shure 556.	—	ZEJIC
A105	Clip-on mic. stand; state diameter of pipe.	C	ZEJOD
A115	For RCA 77 Series Microphone.	A	ZEJUF
A118	For RCA 88 Series Microphone.	F	ZEJYG
A127	For W. E. 639 Series Microphone.	—	ZEJZA
A117	For RCA 44 Series Microphone.	Similar to A	ZEKBA
A116	For RCA 74 Series Microphone.	Similar to A	ZEKBA

NOTE—A116 and A117 have side plates and rectangular top plate instead of curved.

As each call letter plate is individually cast for your call letters, delay in shipping is about 3 weeks. Due to large number of varied types of microphones, it is suggested the A105 clip-on call letter plate be used where the microphone is not one of those shown above. Also, as many microphones are similar in size, several of the above plates are adaptable with only slight shimming, etc.

CONNECTORS — HEADPHONES — TELEGRAPH KEYS — FANS



Cannon P Series Connectors

Probably the most used connector in Radio, TV, and Communications. Approximately $1\frac{1}{8}$ " diameter. Figs. B and C, above, are about $2\frac{1}{4}$ " long. Satin chrome finish. All types have latch locks.

Symbol	Description	Cat. No.
A	Receptacle for chassis mounting, male, 3 prong.	P3-14
B	Cable receptacle, female, 3 prong.	P3-CG-11S
C	Cable plug, male, 3 prong.	P3-CG-12S
D	Receptacle for chassis mounting, female, 3 prong.	P3-13
E	Wall plate with 3 prong female receptacle.	P3-35
F	Wall mounting with two 3 prong female receptacles.	P3-35-2G
E	Wall plate with 3 prong male receptacle.	P3-36
F	Wall mounting with two 3 prong male receptacles.	P3-36-2G

Cannon XL Series Connectors

A smaller Cannon connector with latch lock feature. Increasingly popular. About $\frac{3}{4}$ " diameter. Figs. H and K about $1\frac{3}{4}$ " long. Most types finished in bright nickel.

G	Receptacle for chassis mounting, male, 3 prong.	XL-3-14
H	Cable receptacle, female, 3 prong.	XL-3-11
J	Receptacle for chassis mounting, female, 3 prong.	XL-3-13
K	Cable plug, male, 3 prong.	XL-3-12
L	Wall plate with 3 prong female receptacle.	XL-3-35
L	Wall plate with 3 prong male receptacle.	XL-3-36
—	Double wall plate with two 3 prong female receptacles.	XL-3-35-2G
—	Double wall plate with two 3 prong male receptacles.	XL-3-36-2G

Hubbel Connectors

Popular twist lock 10 ampere type in various styles.

M	Chassis mounting 3 prong female.	7557
N	Male, 3 prong, twist lock plug, metal sheathed.	7572
P	Female, 3 prong, twist lock extension socket.	7559

Amphenol Connectors

Q	Chassis connector 3 prong female.	91-PG3F
R	Male cable connector, 3 prong.	91-MC3M
S	Female cable connector, 3 prong.	91-MC3F

Other Connectors—Those listed above are 3 prong, most used in radio and TV audio service. Gates can supply the above and other connectors in any number of connections. P series available from 2 to 8 contacts. XL series from 1 to 4 contacts.



HEADPHONES



A fine dual headphone with 5 ft. cord. Bimorph crystal drive element assures wide response up to 8000 cycles. Net weight 6 ozs. Made by Brush.

Crystal headphones. Cat. A

Same as above but with extended frequency range 60-10,000 cycles.

Deluxe crystal headphones. Cat. A1

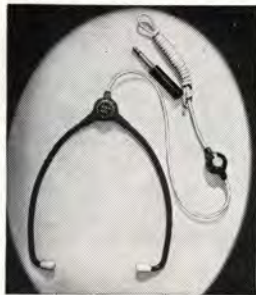

Telex Monoset

New comfort in headset monitoring. Wear under the chin instead of over the head. Made of durable Tenite. Weight 1.2 ozs. Sensitivity 88 db above .000204 dynes per square centimeter for 10 microwatts input. Both models include volume control in cord set.

Monoset, 2000 ohms. Cat. 2841

Monoset, 500 ohms. Cat. 2842



Telex Twinset

The lightest weight headset made, only 1.6 oz. Sound piped to ear through slender tubular sound arm. Adjustable to any head. Full range high fidelity. Tenite construction with Z-Nickel steel headband. Here is a unit that eliminates all outside noises and, thus, is particularly good for remotes. 5 ft. cord. No volume control.

Twinset, 1000 ohms. Cat. 3725
Twinset, 64 ohms. Cat. 3735



Standard Semi-Automatic Key

Improved standard model mounted on heavy steel base $6\frac{1}{4}$ "x $3\frac{1}{2}$ "x $\frac{1}{2}$ ". Five adjustments assure dependable operation at all speeds. Complete with circuit closing switch and adjustable weight. All parts have heavy chrome plating. Contacts $\frac{1}{4}$ ". Base chrome plated.

Standard semi-automatic key. Cat. 114-501
Same as above only left handed. Cat. 114-501L

Heavy Duty Key

Large $\frac{1}{4}$ " coin silver contacts, chrome base. Navy type knob. Adjustable steel bearings and well designed spring give light keying touch. Finest hand key money can buy.

Heavy duty key. Cat. 114-321



Rack Cabinet Ventilating Fan



For use with RAK1 rack cabinet listed on Page 63. Mounts in top to withdraw hot air where heat dissipation of rack mounted equipment is greater than convective ventilation will handle, such as large number of plug-in amplifiers in one cabinet, etc. Fan, quiet operating for continuous duty. 115 volt, 50-60 cycles.

Fan and plate as illustrated.

Cat. RAK-F-1

INTER-COMMUNICATION SYSTEMS — MOBILE TRANSMITTER

Two-Station System Complete



A complete 2-Station System with nothing else to buy. Consists of one master unit and one sub-unit, as illustrated, and 50 ft. cable. Additional cable may be purchased, as listed below. Operation up to 2000 ft. between units. Volume may be adjusted as desired. Sub-Station may be connected for private or non-private use. When connected for private use, the Master Station cannot listen in on the other station. Operates 110-115 volts AC or DC. Finish walnut.

Complete 2-station system.
3-conductor cable.

Cat. LC-2
Cat. 5303



Ten (or less) Station System



Consists of LM-10 Master Station and any number of Sub-Stations up to ten. Master-Station can talk privately to any one of the Sub-Stations, or to all Sub-Stations at one time. Sub-Stations can be connected privately or non-privately. Sub-Stations can always originate calls to Master Station. Only the Master Station requires electric current. Size: 8¼"x6¼"x7½". Finish: walnut. For 105-115 volts AC or DC.

Master Station for 5 or less Sub-Stations.
Master Station for 10 or less Sub-Stations.
Sub-Station.
3-conductor cable.

Cat. LM-5
Cat. LM-10
Cat. LR-3
Cat. 5303



Earphone Master Stations



The LC-2, LC-5 and LC-10 equipments may be purchased with earphone attached for privacy. Lifting the earphone disconnects the speaker; and visa versa when earphone is placed on hook. Where desiring earphone on any station listed above, add the suffix X after the type number. For example, (LM-5X) would give you a 5-station master unit with earphone added.

New Chief Talk-A-Phone



Master Station

Note—Cradle phone set or earphone can be supplied at slight extra cost. Bulletin, available on request, gives added wiring and explanatory detail.

For office or factory, the Redi-Power Talk-A-Phone is as complete as intercoms can be made. Available in six, twelve, twenty and thirty unit capacity. Any number of Masters may be used, or a mixture of Master and Staff Stations. Staff Stations may originate to or answer Master Station. Staff Stations require no electrical power. Full 10 watts output, which puts it in paging class, if desired. Output level is automatically balanced to load; i. e., level is the same whether one or several speakers are being called. Push-button control allows conferences between a selected group of stations. Has dictation control. Master Station is available with or without cradle head set for privacy. Size: 12"x9"x7".

Redi-Power Master Station, 12 circuits.

Cat. C5912

Redi-Power Master Station, 20 circuits.

Cat. C5920

Staff Station to originate 1 call to Master.

Cat. C-41

Same as C-41, but with metal cabinet for wall mounting.

Cat. C-41M

Nine inch weatherproof re-entrant horn.

Cat. C-20

Cable for interconnecting staff to Master Stations.

Cat. 6204



Re-entrant horn



Staff Station

MOBILE TRANSMITTER



Designed to operate in the 26 mc band for short distance remote broadcasting between studio and remote point. This AM transmitter comes with whip antenna and hand type carbon microphone. May be used with remote amplifier for multiple microphone mixing, or higher quality reproduction.

Operates from 6 volt battery with current drain approximately 25 amps. Output: 10 watts. Crystal controlled. Modulates 100% class AB. Input: 600 ohms 0 db, with current provided where carbon microphone is used. Response: 100-5000 cycles with 2 db. Noise: 45 db below 100% modulation. Distortion: 5% or less, 100-5000 cycles. Tubes: two 6L6, one 2E26, one 6AG7. Size: 18¾"x8"x11". Supplied with shock mounts, as illustrated.

It is emphasized that transmitters for this service are not designed for long distance service. They are primarily for short distances, to fill the gap where telephone lines are not available or practical. For receivers, see pages 114 and 115.

Complete transmitter with tubes, microphone and whip antenna.
Cat. RP-10



A. C. GENERATING POWER PLANTS

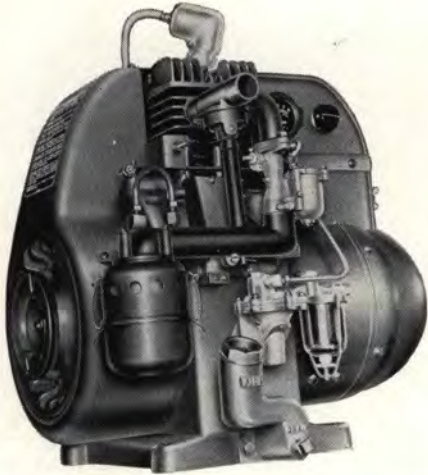

1000 Watt For Studio or Sound

To operate studio equipment during a power failure, or a sizable sound system, this well known Onan quality product will perform to utmost satisfaction. It is a one cylinder, 4 cycle, air cooled unit with built-in governor, radio shielded ignition, and develops 2.57 HP at 1800 RPM. Available with manual and remote starting. Remote starting type requires two 6 volt 80 ampere hour storage batteries as accessories.

MODEL SELECTION

Model	Starting	Volts	Cycle	Wire	Phase
10LS*	Remote	115	60	2	1
10L	Manual		60	2	1
10LS*	Remote	230	60	2	1
10L	Manual		60	2	1

*See Special Accessories for Automatic Panel and Line Transfer Panel.

*Above Models available in 50-cycle with capacity reduced to 800 watts due to lower engine speed.

Maximum Amperes: 8.6 Amps at 115 Volts; 4.3 Amps at 230 Volts.

MODEL SELECTION

Model	Starting	Volts	Cycle	Phase	Wire
305CK-1R	Remote	115	60	1	2
305CK-1P**	Manual		60	1	2
305CK-1M	Manual		60	1	2
305CK-2R	Remote	230	60	1	2
305CK-2P**	Manual		60	1	2
305CK-2M	Manual		60	1	2
305CK-3R	Remote	115 OR 230	60	1	3
305CK-3P**	Manual		60	1	3
305CK-3M	Manual		60	1	3

AMPERE RATINGS: 30.4 Amps at 115 Volts; 15.2 Amps at 230 Volts.

**Mounted in hooded carrying frame.

115 OR 230
3500 Watt

A. C. Generator

Will handle a 250 watt transmitter, up to A3 tower lights, usual accessories, and one or two building lights. This unit is a two cylinder, 4 cycle, 7.2 HP engine at 1800 RPM. Radio shielded. Consumes 0.195 gallon per kw hour. Voltage regulation $\pm 3\%$. Frequency regulation within 3 cycles of rated frequency. Available in both manual and remote starting types.



5000 and 10,000 Watt Plants

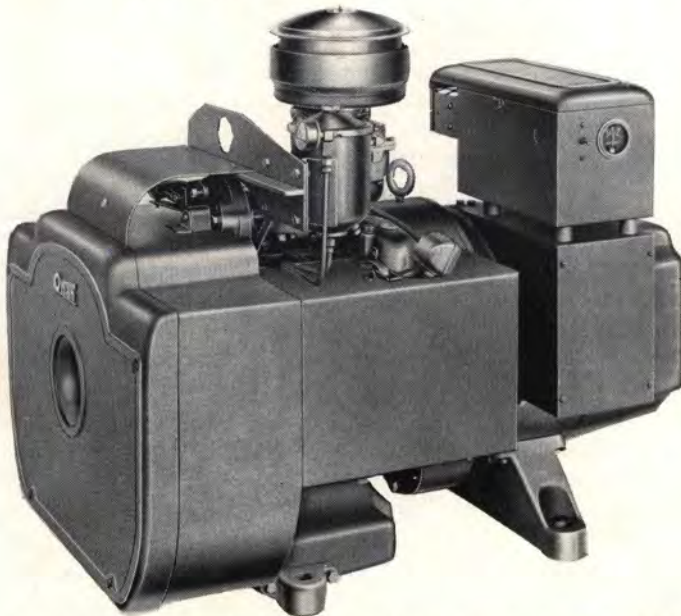

MODEL SELECTION — 5 KW

Ratings			Models	Start- ing	Volts	Cycle	Phase	Wire
KW	KVA	@ PF						
5	5	100%	5CW-3M	Manual	115/230**	60	1	3
5	5	100%	5CW-3R	Remote*	115/230**	60	1	3
5	6.25	80%	5CW-4M	Manual	120/208	60	3	4
5	6.25	80%	5CW-4R	Remote	120/208	60	3	4
5	6.25	80%	5CW-5M	Manual	230	60	3	3
5	6.25	80%	5CW-5R	Remote*	230	60	3	3
5	6.25	80%	5CW-7M	Manual	220/380	60	3	4
5	6.25	80%	5CW-7R	Remote	220/380	60	3	4

50-CYCLE MODELS: Available for all voltages listed above. Ratings remain the same, with ample overload guaranteed.

*AUTOMATIC CONTROLS available for these models.

**MAY BE CONNECTED TO DELIVER: 115 Volts only, 230 Volts only, or combination 115/230 Volts.

MODEL SELECTION — 10 KW

Ratings			Models	Start- ing	Volts	Cycle	Phase	Wire
KW	KVA	@ PF						
10	10	100%	10CW-3M	Manual	115/230**	60	1	3
10	10	100%	10CW-3R*	Remote	115/230**	60	1	3
10	12.5	80%	10CW-4M	Manual	120/208	60	3	4
10	12.5	80%	10CW-4R	Remote	120/208	60	3	4
10	12.5	80%	10CW-5M	Manual	230	60	3	3
10	12.5	80%	10CW-5R*	Remote	230	60	3	3
10	12.5	80%	10CW-6M	Manual	460	60	3	3
10	12.5	80%	10CW-6R	Remote	460	60	3	3
10	12.5	80%	10CW-7M	Manual	220/380	60	3	4
10	12.5	80%	10CW-7R	Remote	220/380	60	3	4

50-CYCLE MODELS: Available for all voltages listed above. Rating is 8KW (due to reduced engine speed) with overload.

*AUTOMATIC CONTROLS available for these models.

**MAY BE CONNECTED TO DELIVER: 115 Volts only, 230 Volts only, or combination 115/230 Volts.

For the first time, a 5 or 10 kw power plant no station should be without—and at a price any station can afford. Available in manual or remote starting. A two cylinder, 4 cycle engine, air cooled unit. Voltage accuracy within 3%. Frequency accuracy within 3 cycles. This plant will pay for itself during only one serious power outage.

A. C. GENERATING POWER PLANTS



- 15 kw
- 25 kw
- 35 kw

These professional power plants are built to stand the rigors of long, uninterrupted service, and are available in powers up to 35 kw. For example, a 15 kw unit is sufficient for a 1 kw station, all accessories, as many as 4 towers with A3 lights, and building lighting. — The 25 kw unit will perform the same function for a 5 kw transmitter installation, and the 35 kw for the complete multi-tower 10 kw installation.

The power plant is completely housed. It has remote starting, requiring only two six volt 80 ampere hour batteries. Six cylinder, 45.4 HP, 1800 RPM engine. Includes running time meter, battery charging for remote starting batteries, oil bath cleaner, gear type oil pump, radio suppression and centrifugal weight type governor. — Generator is the revolving field type, direct connected, with inherent voltage regulation and frequency accuracy within 3 cycles. This power plant has an abundance of overload capacity. Instrument panel includes: voltmeter; dual ammeters for single phase, or one ammeter with selector switch for 3 phase; and circuit breaker with manual reset.

Constructed on welded structural steel base. Cover is of snap-down design, and fully waterproof. Finish: metallic gray.

MODEL SELECTION 15 kw

Model	Volts	Cycle	Wire	Phase
15HK-3R	115/230	60	3	1
15HK-4R	120/208	60	4	3
15HK-5R	230	60	3	3
15HK-7R	220/380	60	4	3
14HK-53R	115/230	50	3	1
14HK-54R	120/208	50	4	3
14HK-55R	230	50	3	3
14HK-57R	220/380	50	4	3

Capacity of 50-cycle units reduced to 14KW due to lower engine speeds.

MODEL SELECTION 25 kw

Model	Volts	Cycle	Wire	Phase
25HN-3R	115/230	60	3	1
25HN-4R	120/208	60	4	3
25HN-5R	230	60	3	3
25HN-7R	220/380	60	4	3
20HN-53R	115/230	50	3	1
20HN-54R	120/208	50	4	3
20HN-55R	230	50	3	3
20HN-57R	220/380	50	4	3

Capacity of 50-cycle units reduced to 20KW due to lower engine speeds.

IMPORTANT: If load is to be primarily motors or other low power factor equipment, Voltage Regulated Models are recommended. When units are equipped with voltage regulators, 60-cycle models are rated at 25 KW—31.25 KVA at 0.8 power factor; 50-cycle models at 20 KW—25.0 KVA at 0.8 power factor. Voltage regulation is plus or minus 3%. Voltage Regulated Models are supplied at added cost.

An electric plant designed for use **without** a voltage regulator **cannot** be used with a voltage regulator; therefore, voltage regulator must be specified at the time the electric plant is ordered.

MODEL SELECTION 35 kw

Model	Watts	Volts	Cycle	Phase	Wire
35JT-3R	35,000	115/230	60	1	3
35JT-4R	35,000	120/208	60	3	4
35JT-5R	35,000	230	60	3	3
35JT-6R	35,000	460	60	3	3
35JT-7R	35,000	220/380	60	3	4
30JT-53R*	30,000	115/230	50	1	3
30JT-54R*	30,000	120/208	50	3	4
30JT-55R*	30,000	230	50	3	3
30JT-56R*	30,000	460	50	3	3
30JT-57R*	30,000	220/380	50	3	4

*Reduced capacity due to lower engine speed.

IMPORTANT: If load is to be primarily motors or other low power factor equipment, Voltage Regulated Models are recommended. When units are equipped with voltage regulators, 60-cycle models are rated at 35 KW—43.75 KVA at 0.8 power factor; 50-cycle models at 30 KW—37.5 KVA at 0.8 power factor. Voltage regulation is plus or minus 3%. Voltage Regulated Models are supplied at added cost.

An electric plant designed for use **without** a voltage regulator **cannot** be used with a voltage regulator; therefore, voltage regulator must be specified at the time the electric plant is ordered.

Automatic Line Transfer



In certain operations, automatic transfer from the power line, that has failed, to the generating plant is desirable. Where the few moments required to start the stand-by generator are not objectionable then, of course, the automatic transfer equipment is not necessary. Consists of all necessary relays and controls to (in case of power failure) automatically start the generating plant and transfer

the load from power line to generator. When power is restored, the opposite action takes place—all automatically.

As these transfer panels vary widely as to the model, voltage, and phase of the power plant, we suggest that these units be quoted to specifications—which Gates will gladly do, without delay.

TRANSFORMERS

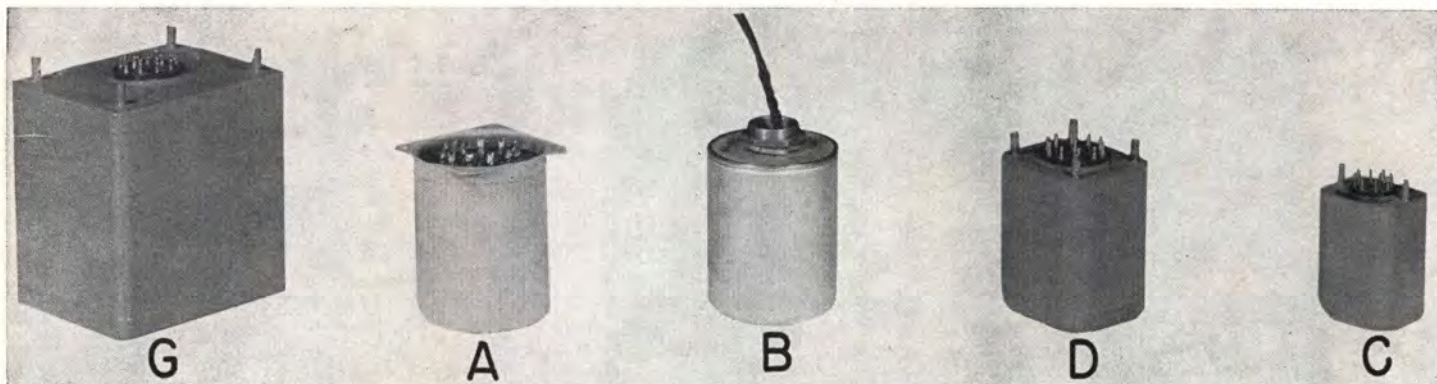

All transformers listed on this, and the following pages, are of commercial quality and are designed for both continuous duty and to meet the highest standards. The large majority of transformers are cased and fully impregnated. In many instances they are the same transformers used in Gates manufactured equipment. This assures not only top performance, and lower price but also because of quantity purchases, stock availability. Gates will be glad to work out transformer packages—such as combination modulation transformer, reactor, capacitor, etc.—to arrive at the desired end result. Your correspondence is invited.

INPUT TRANSFORMERS

Application	Pri. Impedance (ohms)	Sec. Impedance (ohms)	Response $\pm 1\frac{1}{2}$ db. (cy./sec.)	Maximum Level	Mounting Case Size See Page 191	Terminals	Catalog No.
Mike, pickup or line to grid	50, 125, 250, 333, 500/600	60,000 (2 sec.)	20-20,000	+14 dbm	A #2	TPL	AI-3001U
Mike, pickup or line to grid	50, 125, 200, 250, 333	120,000 (2 sec.)	20-20,000	+14 dbm	A #2	TPL	AI-3002U*
Mike, pickup or line to grid	50, 25 (C.T.)	60,000	30-15,000	0 dbm	B #4	WL	AI-3006T***
Mike, pickup or line to grid	250, 600	60,000	30-15,000	+10 dbm	B #4	WL	AI-3009T****
Mike, pickup or line to grid	50, 600 (C.T.)	80,000	50-15,000	+10 dbm	B #4	WL	AI-3011T****
Input	150, 600 (C.T.)	78,000	30-15,000	+ 8 dbm	C #5	TPL	AI-7638T**
Input	30, 600 (C.T.)	78,000	30-15,000	+ 8 dbm	C #5	TPL	AI-7639T**
Input	30, 150 (C.T.)	78,000	30-15,000	+ 8 dbm	C #5	TPL	AI-7683T**
Input	150, 600 (C.T.)	60,000	30-15,000	0 dbm	B #4	WL	AI-7715T***
Input	30, 150 (C.T.)	60,000	30-15,000	0 dbm	B #4	WL	AI-7716T***
Input	50, 200/250, 500/600	50,000	50-10,000	0 dbm	F #3	TPL	AI-8357U
Univ. mike or line to grid	62.5, 150, *250, *600, *(C.T.)	60,000	20-20,000	+10 dbm	C #5	TPL	HS-1**

TERMINATION CODE: TPL—Tinned post lugs; WL—Wire leads.

*4 Mu-Metal Shields
**3 Mu-Metal Shields

***2 Mu-Metal Shields
****1 Mu-Metal Shield

MODULATION TRANSFORMERS

Application	Pri. Impedance	Sec. Impedance	Mounting Case Size	Terminals	Catalog No.
Modulate 1KW transmitter	10,500 ohm C.T.	5000 ohm Class C	R #72	SCT	AM-3161C
Modulate 10KW transmitter	P.P. 3X2500F3 (class B)	Par. 3X2500F3 (Class C)	U #81	CT	AM-3167M
Modulate 5KW	P.P. 3X2500F3 (Class B)	3600 ohms—Single 3X2500F3	R #55	CT	AM-7718C
Modulate 250W transmitter	7500 ohms C.T., Class B 810's	5000 ohms, Parallel 810's	M #56	SCT	BM-1
Modulate 10W communications transmitter	10,000 ohms C.T., P.P. Class B 6L6's	3000, 5000, 8000 ohms—Single 2E26	J #19	WL	M-3X
Modulation 10 Kw. communications	P.P. 3X2500F3	two 3X2500F3 Class C	U —	CT	AM3205M
Modulation 5 Kw. communications	P.P. 3X2500F3	one or two 3X2500F3	U —	CT	AM3204M

All above linear standard except those listed as **communications** which are 200-3500 cycles.



If You Didn't Get This From My Site,
Then It Was Stolen From...

TRANSFORMERS

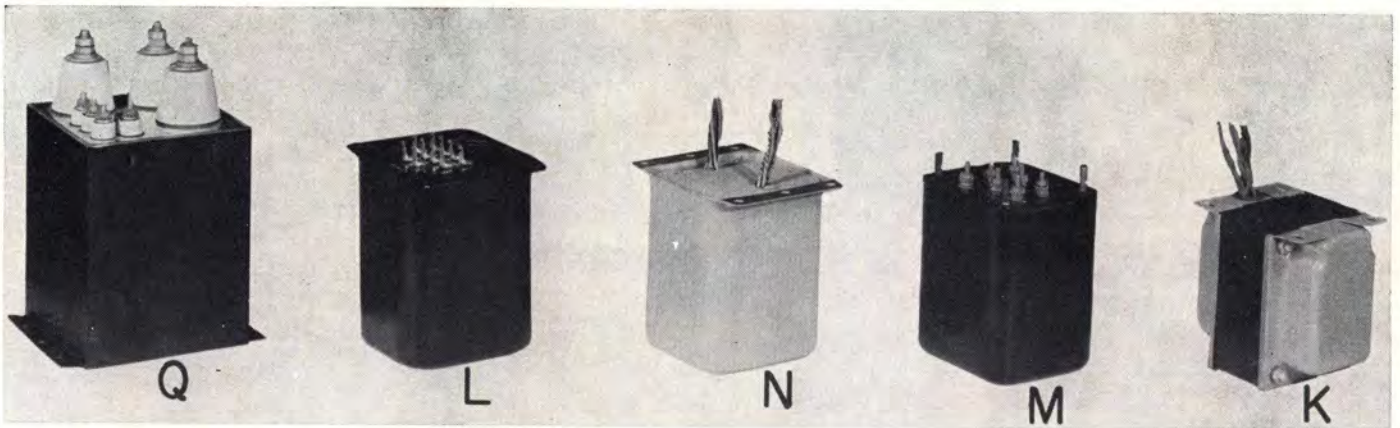

OUTPUT TRANSFORMERS

Application	Pri. Impedance (ohms)	Sec. Impedance (ohms)	Response $\pm 1\frac{1}{2}$ db. (cy./sec.)	Maximum Level	Mounting Case Size (Bottom of Page)	Terminals	Catalog No.
High level output	7,000 (C.T.)	5, 7.5, 15, 250, 500	30-15,000	+40.8 dbm	A #22	TPL	AO-3033U
Low level output	15,000 (split winding)	50, 125, 200, 250, 333, 500/600	30-15,000	+10 dbm	A #2	TPL	AO-3037U
Output	12,000	600	30-15,000	+25 dbm	B #4	WL	AO-3039T
Low level output	15,000	250 or 600	30-15,000	+10 dbm	B #4	WL	AO-3040
High level output	5,500 (C.T.)	250/600	30-15,000	+42.5 dbm.	G #82	WL	AO-3045T
Output	12,000	250/600 (C.T.)	50-15,000	+20 dbm	D #27	TPL	AO-7244T
Output	12,000	150/600 (C.T.)	50-15,000	+20 dbm	D #27	TPL	AO-7640T
Output	12,000	150/600	50-15,000	+20 dbm	D #27	WL	AO-7717T
Output	12,000 (C.T.)	4, 8, 16, 150, 600	50-10,000	15 watts	N #83	WL	AO-8459C
Output	12,000	4, 8, 16, 150, 600	50-10,000	15 watts	N #83	WL	AO-8549C
Output	15,000	150/600 (C.T.)	30-15,000	+10 dbm	B #4	WL	AO-8554T
Output	14,000/20,000	1½, 3, 5, 8, 16, 200, 500	40-10,000	20 watts	A #26	TPL	CG-710
Output	15,000	150/600 (C.T.)	30-20,000	+15 dbm	M #28	SCT	BO-1
Output	10,000 (C.T.)	4, 8, 16, 150, 600	50-10,000	15 watts	L #29	TSL	PSO-150

TERMINATION CODE: TPL—Tinned post lugs; WL—Wire leads; SCT—Screw terminals; TSL—Tinned solder lugs.

TRANSFORMER CASE DIMENSIONS

Size	Width or Diameter	Depth	Height	Size	Width or Diameter	Depth	Height	Size	Width or Diameter	Depth	Height
2	2½	2½	3¼	27	2	2½	2¾	64	7	8	9¼
3	1½	1½	2	28	2½	2½	3	65	11½	11½	13
4	1¾	—	3¼	29	3¼	4	4¼	66	7	7½	8
5	1½	1¾	2½	30	3¼	4	3¾	67	7½	7¾	8½
6	1½	2½	1½	31	5½	5½	6½	68	7¼	10½	9
7	2½	3½	3	33	4½	5½	5½	69	5¼	6	6½
8	2¼	3¼	2¾	34	1½	2¾	1¾	70	21	29	43
9	2¾	3¾	3¾	35	3½	4½	5½	71	15	27	36
10	1½	1½	2¼	36	7½	7¾	8½	72	11¼	16	10½
11	1¾	1¾	2½	38	23½	23½	29¾	73	4¼	5¼	5¾
12	2¼	2¼	2¾	39	8½	9	8½	74	2¾	3¾	4
13	1¼	1½	2¾	40	21	23	30	75	4½	5½	4¾
14	5½	6	6½	45	5½	5½	5½	76	4	4½	5½
15	2¼	2½	3	46	3¾	3¾	4½	77	3¾	4½	5
16	2	2¾	3	50	3	3¾	3½	78	4½	4¾	7½
17	2	2¾	3½	55	22	30	32	79	3¾	4½	6
18	2	3¼	2	56	5¼	6½	7	80	2½	3¾	3¾
19	2¼	3¾	2¼	57	6¼	7½	7¼	81	21½	34½	52
21	3¾	4½	4¾	59	11½	11½	10½	82	3½	3¾	4½
22	3¾	3¾	4½	60	4½	5¼	6	83	3¾	4	4¼
24	1½	3¼	2	61	6	7	9½	84	2½	2½	3¾
25	11	12	11	62	9	10	8½	85	4¼	4½	6½
26	3	3	3¾	63	28	35½	42	86	14	8	18

TRANSFORMERS



SPECIAL TRANSFORMERS

Application	Pri. Impedance (ohms)	Sec. Impedance (ohms)	Response $\pm 1\frac{1}{2}$ db. (cy./sec.)	Maximum Level	Mounting Case Size	Terminals	Catalog No.
Multiple line to multiple line	50, 125, 200/250, 333, 500/600	-50, 125, 200/250, 333, 500/600	30-15,000	+10 dbm.	A #10	TPL	AS-3154U
Single to multiple line	600	-Sec. 1: 600 Sec. 2: 600	30-15,000	+20 dbm.	A #11	TPL	AS-3155U
Single to multiple line	600	-Sec. 1: 600 Sec. 2: 600 Sec. 3: 600	30-15,000	+20 dbm.	A #13	TPL	AS-3157U
Driver	P. P. 845 plates	-P. P. 833 grids	30-15,000	P #14	SCT	AS-3158C
Driver	Match 4 845's P.P. Par.	-Match 2, 3X2500F3 grids	30-20,000	O #36	SCT	AS-3172C
Driver	P.P.P. 845 plates	-P. P. Class B 3X2500F3 grids	± 3 db, 150 to 4000 cy.	M #85	SCT	AS-3174C
Line to line	62.5, 150, 250, 600	-62.5, 150, 250, 600	10-30,000	+20 dbm	C #13	TPL	HS-66
Low pass filter	15,000	-100,000	Attenuation above 3000	10V. RMS across sec.	L #15	SLT	LPF-1
Line to speaker	500	-16/8	25 watts	H #7	TSL	Z-3342
Line to speaker	500	-3/4	3.5 watts	H #6	SCT	ZL-2021
Line to speaker	500, 1000, 1500, 2000	-6/8	10 watts	I #8	APT	ZY-2002
Line to speaker	500, 1000, 1500, 2000	-6/8	16 watts	I #9	APT	ZY-2003
Line to speaker	500, 1000, 1500, 2000	-3/4	10 watts	I #8	APT	ZY-4004
Line to line	62.5/150	-62.5/150	$\pm \frac{1}{2}$ db., 30-15,000	+16 dbm.	E #16	TPL	114A
Line to line	250/600	-250/600	$\pm \frac{1}{2}$ db., 30-15,000	+20 dbm.	E #17	TPL	114B
Line to line	62.5/150	-250/600	$\pm \frac{1}{2}$ db., 30-15,000	+16 dbm.	E #16	TPL	114C
Line to line	250/600	-62.5/150,	$\pm \frac{1}{2}$ db., 30-15,000	+16 dbm.	E #16	TPL	114C
Impedance matching	62.5/150, 250/600, 150/2500, 600/10,000	-250/600					

TERMINATION CODE: TSL—Tinned solder lugs; APT—Adjustable pin terminals; SCT—Screw terminals; SLT—Solder lug terminals.

FILAMENT TRANSFORMERS

Primary Volts	Volts	Amps	Insulation Volts (RMS)	Mounting Case Size	Terminals	Catalog No.
115.....	10	2	1000	A #2	TPL	AF-3091
(50/60 cy.)						
115.....	6.3	2	A #84	TPL	AF-3097
(60 Cy.)	6.3	2				
105, 110, 115.....	6.3 C.T.	7	1000	A #26	TPL	AF-3098
(50/60 cy.)						
215, 230.....	10.2 C.T.	9.0	1500	U #56	SCT	AF-3120C
(50/60 cy.)	10.2 C.T.	9.0				
230 V.....	6.4	4.0	1750	G #60	SCT	AF-3176C
(50/60 cy.)	5.0	2.0				
215, 230, 245.....	7.20 C.T.	10.5	1500	P #73	SCT	AF-3180C
(60 cy.)	6.3	5.0				
215, 230, 245.....	5.0 C.T.	6.5	3500	P #60	SCT	AF-7234C
(50/60 cy.)	5.0 C.T.	6.5				
215, 230, 245.....	5.5 C.T.	15	1750	P #60	SCT	AF-7236C
(50/60 cy.)	10.5 C.T.	6.5				
215, 230, 245.....	10.5 C.T.	6.5	1750	P #60	SCT	AF-7237C
(50/60 cy.)	6.5	2.5				
117, 234.....	6.5	4	1750	P #74	SCT	AF-7237C
(50/60 cy.)						
117, 234.....	6.5	2	1750	P #74	SCT	AF-7238C
(50/60 cy.)						
215, 230, 245.....	7.8 C.T.	51	1750	P #64	SCT	AF-7240C
(50/60 cy.)						
215, 230, 245.....	10.5 C.T.	5	1500	P #75	SCT	AF-7241C
(50/60 cy.)	10.5 C.T.	10				
215, 230, 245.....	6.3	1.5	9000	O #79	SCT	AF-7242C
(50/60 cy.)	5	10				
105, 110, 120.....	10.5 C.T.	7.5	2500	P #33	SCT	AF-7428C
(50/60 cy.)	6.3 C.T.	4.0				
105, 110, 120.....	10.5 C.T.	7.5	2500	L #76	SCT	AF-7429C
(50/60 cy.)	6.3 C.T.	4.0				
105, 110, 120.....	10.2 C.T.	5.0	2500	P #30	SCT	AF-7432C
(50/60 cy.)						
105, 110, 120.....	5.1 C.T.	20.0	10,000	O #31	SCT	AF-7433C
(50/60 cy.)						
105, 110, 120.....	10.5 C.T.	10	2500	P #21	SCT	AF-7434C
(50/60 cy.)						
105, 110, 120.....	10.5 C.T.	20	2500	P #31	SCT	AF-7435C
(50/60 cy.)						
215, 230, 245.....	7.8 C.T.	51	1750	P #64	SCT	AF-7782C
(60 cy.)						
215, 230, 245.....						
(50/60 cy.)						

case dimensions, see Page 191.

(continued page 193)

TRANSFORMERS



FILAMENT TRANSFORMERS (continued)

Primary Volts	Volts	Amps	Insulation Volts (RMS)	Mounting		Terminals	Catalog No.
				Case	Size		
115, 130..... (50/60 cy.)	6.3 C.T.	10	2500	P	#35	TSL	AF-7994K
105, 110, 120..... 105, 110, 120 (50/60 cy.)	2.6 C.T.	10	9000	O	#77	SCT	AF-8003C
215, 230, 245..... (40/60 cy.)	5 C.T.	10	10,000	Q	#78	SCT	AF-8334C
215, 230, 245..... (40 cy.)	7.8 C.T.	51	1750	P	#36	SCT	AF-8345C
115..... (60 cy.)	6.3 C.T.	1.2	1500	K	#34	WL	F-14X

TERMINATION CODE: TPL—Tinned post lugs; SCT—Screw terminals; WL—Wire leads; TSL—Tinned solder lugs.

POWER TRANSFORMERS

Primary Volts	High Voltage Secondary			Fil. #1		Fil. #2		Fil. #3		Mounting		Terminals	Catalog No.
	AC Volts	DC Amp	DC V Out.	Volts	Amps	Volts	Amps	Volts	Amps	Cast	Size		
115 (50/60 cy.)	300-0-300	.050	6.3	1	6.3 C.T.	2.5	A	#22	TPL	AP-3061U
115 (50/60 cy.)	400-0-400	.200	6.3 C.T.	8	6.3 C.T.	10	2.5 C.T.	2	A	#45	TPL	AP-3062U
115 (50/60 cy.)	375-0-375 325-0-325 350-0-350	.100	5	3	6.3 C.T.	5	A	#46	TPL	AP-3065U
115 (60 cy.)	700 C.T.	.030	6.3 C.T.	2.5	N	#80	WL	AP-3078
230, 3 phase (60 cy.)	2160 RMS per leg	4.5	U	#70	CT	AP-3090M
215, 230, 245 (40/60 cy.)	1700-0-1700	.85	1500	S	#38	SCT	AP-7235C
215, 230, 245 (50/60 cy.)	375-0-375	1.0	300	P	#69	SCT	AP-7239C
105, 110, 120 (50/60 cy.)	238/0/238	.300	130 choke input	5	6	P	#35	SCT	AP-7430C
105, 110, 120 (50/60 cy.)	465/0/465	.150	350 choke input	5	3	P	#35	SCT	AP-7431C
105, 110, 120 (50/60 cy.)	2160 RMS per leg	2.5	5000	10	U	#71	CT	AP-8000M
230, 3 phase (50/60 cy.)	750 C.T.	.160	5	2	6.3	8	6.3 C.T.	2.65	K	#41	WL	AP-8093T
115 (50/60 cy.)	2820-0-2820	.300	2500	R	#67	SCT	P-2520
115, 230 (50/60 cy.)	2260-0-2260	.090	2000	K	#50	WL	R-11A
115 (60 cy.)	700 C.T.	5	3	6.3 C.T.	3.5	K	#50	WL	R-11A
230 V 60C 3 phase	3750, 3520, 2200 per leg	0.82	8500 8000 5000	U	#70	CT	7P91
208 (50/60 cy.) 3 phase	230-3 ph.	25 KVA	#86	CT	AS8766M

TERMINATION CODE: WL—Wire leads; TPL—Tinned post lugs; SCT—Screw terminals; CT—Clamp terminals.

REACTORS

Application	Inductance (henries)	Max. DC (amps.)	DC Resistance (ohms)	Mounting		Terminals	Catalog No.
				Case	Size		
Filter choke.....	8	.080	250	A	#12	TPL	AC-3121U
Filter choke.....	10	.150	120	A	#22	TPL	AC-3122U
Mod. reactor.....	48.7	.650	130	R	#25	SCT	AC-3135C
Swinging choke.....	5 to 16	1.5 to .15	28.7	R	#59	SCT	AC-3136C
Filter choke.....	10	.250	84	O	#60	SCT	AC-3137C
Filter choke.....	3.5	.500	36	O	#60	SCT	AC-3138C
Filter choke.....	8	.750	42	O	#61	SCT	AC-3140C
Smoothing choke.....	8	1.0	34	R	#39	SCT	AC-3141C
Filter choke.....	4	1.5	14	R	#62	SCT	AC-3143C
Filter choke.....	4	2.8	6.4	R	#57	SCT	AC-3146C
Transient choke.....	0.1	3	2.06	R	#65	SCT	AC-3147C
Filter choke.....	2	2.8	6.4	R	#65	SCT	AC-3146C
Mod. reactor—10 KW.....	26	1.4	75	U	#63	CT	AC-3168M
Mod. reactor—5 KW.....	60	1.4	75	T	#38	CT	AC-3170C
Swinging choke.....	5-16	.750-100	41	O	#64	SCT	AC-7427
Mod. reactor—5 KW.....	60	1.4	75	T	#40	CT	AC-7719C
Mod. reactor.....	65	.250	O	#66	SCT	BR-1
Smoothing choke.....	6	.160	165	I	#19	TSL	C-12X
Filter choke.....	8	.080	250	K	#24	WL	R-18

TERMINATION CODE: TSL—Tinned solder lugs; TPL—Tinned post lugs; WL—Wire leads; CT—Clamp terminals; SCT—Screw terminals.

For transformer case dimensions, see Page 191.

ATTENUATORS, FIXED PADS, DIALS, PRESIDENTIAL AMPLIFIER

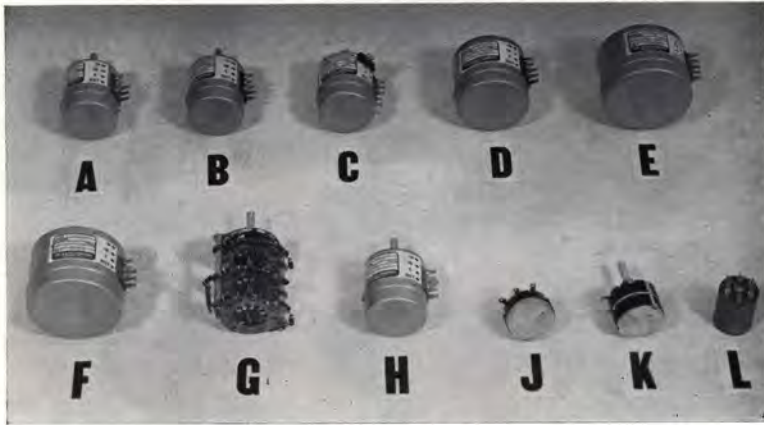

ATTENUATORS (Daven)

Illus.	Type	Terminal Impedance	Network	Steps	Taper
A	LA-350-K	150/150	Ladder	20-2DB	Infinity
A	LA-350-EF	250/500	Ladder	20-2DB	Infinity
A	LA-350-F	500/500	Ladder	20-2DB	Infinity
A	LA-350-G	600/600	Ladder	20-2DB	Infinity
B	*LAQ-350-EF	250/500	Ladder	20-2DB	Infinity
B	*LAQ-350-G	600/600	Ladder	20-2DB	Infinity
C	**Spec. 2574-EF	250/500	Ladder	20-2DB	Infinity
D	LA-730-EF	250/500	Ladder	30-1.5DB	Infinity
D	LA-730-F	500/500	Ladder	30-1.5DB	Infinity
D	T-257-G	600/600	T	30-1.5DB	No Taper
E	T-330-G	600/600	T	30-1.5DB	Infinity
E	BAL-330-G	600/600	Bal-Ladder	30-1.5DB	Infinity
F	**TA-1000-4	7100/3900	T	20-2DB	+4 to +42VU and off
G	**A-4311-101	7500/3900	T	6	+4 to +30DB

*With Cue Switch
**For use as meter multiplier with any standard VU meter.
***With miniature switch.

LEVER TYPE ATTENUATORS (Daven)

Illus.	Type	Terminal Impedance	Network	Steps	Taper
M	LA-821-K	150/150	Ladder	20-2DB	Infinity
M	LA-821-G	600/600	Ladder	20-2DB	Infinity
M	T-831-K	150/150	T	30-1.5DB	Infinity
M	T-831-G	600/600	T	30-1.5DB	Infinity

TAPPED FIXED NETWORKS

Illus.	Type	Terminal Impedance	Network	Description
N	1030-K	150/150	T	0 to 40 DB in 1 DB Steps
N	1030-G	600/600	T	
N	1230-K	150/150	H	
N	1230-G	600/600	H	

SINGLE INPUT—MULTIPLE OUTPUT PADS

Illus.	Type	Impedance	Network	No. of Inputs	No. of Outputs	DB Loss
N	1130-1	600/600/600	H	1	2	6.0
N	1130-2	600/600/600/600	H	1	3	9.5
N	1130-3	600/600/600	T	1	2	6.0
N	1130-9	600/600/600/600	T	1	3	9.5

POTENTIOMETERS (Daven)

Illus.	Type	Impedance	Description	Sections	Taper
J	A-3404-4	100K ohms	Carbon	1	Audio
J	A-3404-3	500K ohms	Carbon	1	Audio
H	CP-354X	250K ohms	20 Step-2DB	1	Infinity
K	A-5544-2	100K ohms/100K ohms	Carbon	2	Audio

FIXED PADS

Illus.	Type	Impedance	Network	Loss
L	PH-46	150/150	Bal. H	6 DB
L	PH-420	150/150	Bal. H	20 DB
L	PH-16	600/600	Bal. H	6 DB
L	PH-120	600/600	Bal. H	20 DB
L	PH-212	600/150	Bal. H	12 DB
L	PT-46	150/150	T	6 DB
L	PT-420	150/150	T	20 DB
L	PT-16	600/600	T	6 DB
L	PT-120	600/600	T	20 DB
L	PT-212	600/150	T	12 DB

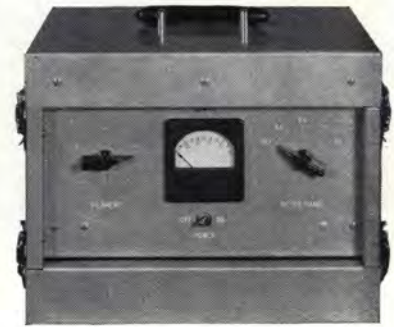

PRESIDENTIAL AMPLIFIER

Illustrated above and below, the Presidential Amplifier with general circuit design and facilities approved as standard by all major networks. Facilities allow a single microphone to feed ten output circuits, thus reducing the battery of microphones in front of the speaker. May be used for feeding radio, TV and movie sound circuits. Battery operated, gain approximately 8 db. Constructed in rugged, one-piece case. Finish hammeroid. Further detail on this instrument available on request.

Presidential amplifier, with tubes and batteries.
Cat. PRE-34



TOOLS AND SUPPLIES



Illus.	Type	Description
A	TM-1	Relay Burnishing Tool
B	TM-5	Armature Adjuster
C	No. 32	Jack Brush
D	TM-2	Spring Bender
E	Davenoil	Attenuator Lubricant
F		Plug Burnishing Paste



DIAL PLATES

Illustrated to the left are available in Program Level, Monitor Level, Mixer 1, Mixer 2, Mixer 3, Mixer 4. Dials to the right are available for reading Input, Output, Audio Level, VU Range, Channel (1-2-3-4-5), Output (Line 1-2), Input (Line-Bridge).

Both types are approximately 3" square, in anodized aluminum, with natural aluminum letters for construction of special equipment; or used with attenuators on this page they are ideal. Use knob S-489-64L-BB.



Attenuators above supplied less dials and knobs. Dials at right. Knobs pages 195 and 214.

Oscilloscope, Volt-Ohm-Meters, Wattmeter, V. T. Voltmeter, Keys, Knobs



5" Vertical Oscilloscope

A new design oscilloscope, reducing bench space to only 9"x8". Controls are more convenient. Cathode ray image is reflected from a high grade front surface mirror mounted in the adjustable cover at the top of the cabinet. Size: 16 1/4" high, 9 1/2" wide, 8" deep. Shipping weight 30 lbs. Made by Simpson. For 105-125 volts, 50-60 cycles.

Mirroscope, with tubes.
Cat. 476

Specifications

SENSITIVITY—

Vertical direct: 12 volts RMS per inch.
Vertical amplifier: 20 millivolts RMS per inch.
Horizontal direct: 14 volts RMS per inch.
Horizontal amplifier: 38 millivolts RMS per inch.

INPUT IMPEDANCE—

Vertical direct: 10 megohms, 15 mmf.
Horizontal direct: 10 megohms, 15 mmf.
Vertical amplifier: 300,000 ohms, 30 mmf.
Horizontal amplifier: 500,000 ohms, 15 mmf.

Model 240 Volt-Ohm-Milliammeter

AC Volts: 0-15, 150, 750, 3000 (1000 ohms per volt).
DC Volts: 0-15, 75, 300, 750, 3000 (1000 ohms per volt).
DC Milliamp-eres: 0-15, 150, 750.



Ohms: 0-3000 (center scale 30); 0-300,000 (CS 3000) with leads.

Simpson Volt-ohm-milliammeter.
Cat. 240

Vacuum Tube Voltmeter

DC VOLTAGE—Ranges: 1.2, 12, 60, 300, 1200 (30,000 with Accessory High Voltage Probe).
INPUT RESISTANCE—10 megohms for all ranges.
DC PROBE—With one megohm isolating resistor.
Polarity reversing switch.
OHMS—Ranges: 1,000 (10 ohms center); 100,000 (1000 ohms center); 1 megohms (10,000 ohms center); 10 megohms (100,000 ohms center); 1,000 megohms (10 megohms center).
AC VOLTAGE—Ranges: 1.2, 12, 60, 300, 1200.
AF VOLTAGE—Ranges: 1.2, 12, 60.
DECIBELS—Ranges: -20 to +3, -10 to +23, +4 to +37, +18 to +51, +30 to +63.
ZERO POWER LEVEL—1 M. W., 600 ohms.
RANGE—20 volts maximum. FREQUENCY—Flat 20 kc to 100 mc.
LINE VOLTAGE—105-125 volts, 50-60 cycles.



Simpson V. T. Voltmeter.
Same as above in roll top case. Cat. 303
Cat. 303RT

Model 260 Volt-Ohm-Milliammeter

The most used unit of its kind and indispensable in radio, TV or electronic maintenance.

MODEL 260 VOLT-OHM-MILLIAMMETER—20,000 ohms per volt DC; 1,000 ohms per volt AC.
VOLTS, AC and DC—2.5, 10, 50, 250, 1,000, 5,000.
OUTPUT—2.5, 10, 50, 250, 1,000.
MILLIAMPERES, DC—10, 100, 500.
MICROAMPERES, DC—100.
AMPERES, DC—10.
DECIBELS (5 ranges)—-12 to +55 db.
OHMS—0-2000 (12 ohms center); 0-200,000 (1,200 ohms center); 0-20 meg-ohms (120,000 ohms center).



Volt-ohm-milliammeter.
In roll top case. Cat. 260
Cat. 260RT



VOLT-AMP-WATTMETER

Very handy where computing power consumption or power loads.

VOLT-AMP-WATTMETER—
AC current, 60 cycles.
Volts: 0-150, 0-300.
Amperes: 0-3, 0-15.
Watts: 0-300, 0-600, 0-1500, 0-3000.
With breakin plug and leads.

Simpson Volt-amp-wattmeter.
Cat. 390

KEYS—MOUNTINGS

Illus. Type	Description
A 170D	Telephone Type Key
B 173N	Telephone Type Key
C 173P	Telephone Type Key
D 55	Mounting Plate for Telephone Keys

TELEPHONE NUMBERS

Gates at New York
Murray Hill 7-7971

Gates at Washington, D. C.
Metropolitan 8-0522

Gates at Houston, Tex.
Atwood 8536

Gates at Quincy, Ill.
8202

Gates in Canada
Montreal, Que.
Atlantic 9441
(Canadian Marconi Co.)

Gates Export—New York, Murray Hill 9-0200.

ROTARY AND LEVER SWITCHES

ROTARY SWITCHES

Illus.	Type	Circuits	Position	Seal.
A	1316-L	1	6	1
A	B-11139-3	3	3	1
A	B-11139-2	2	8	2
A	1325-L	4	5	2
A	1346-L	4	6	4
A	1335-L	6	5	3

LEVER ACTION KEYS

Illus.	Type	Description
B	N-10076	Double Pole, Triple Throw, 3 Position.
B	N-10078	Three Single Pole, Double Throw, One SPST, Spring Return, 2 Position.
B	N-9735	Three SPDT, One SPST, 2 Position.

KNOBS AND HANDLES



Illus.	Type	Description	Color
A	S-489-64L-BB	Large Skirt Knob	Black
B	483-64-40	Small Knob with Pointer	Black
C	2921-L	Small Bar Knob	Black
D	4901-H	Ball Knob for Gates console keys	Black
D	4901-H	Ball Knob for Gates console keys	Red
E	5149-A	Rectangular Knob for Lever keys	Black
E	5149-A	Rectangular Knob for Lever keys	Red
E	5149-A	Rectangular Knob for Lever keys	Red
F	4926	Knob for Nos. 172, 175, 179 keys	Ivory
F	4926	Knob for Nos. 172, 175, 179 keys	Black
F	4926	Knob for Nos. 172, 175, 179 keys	Red

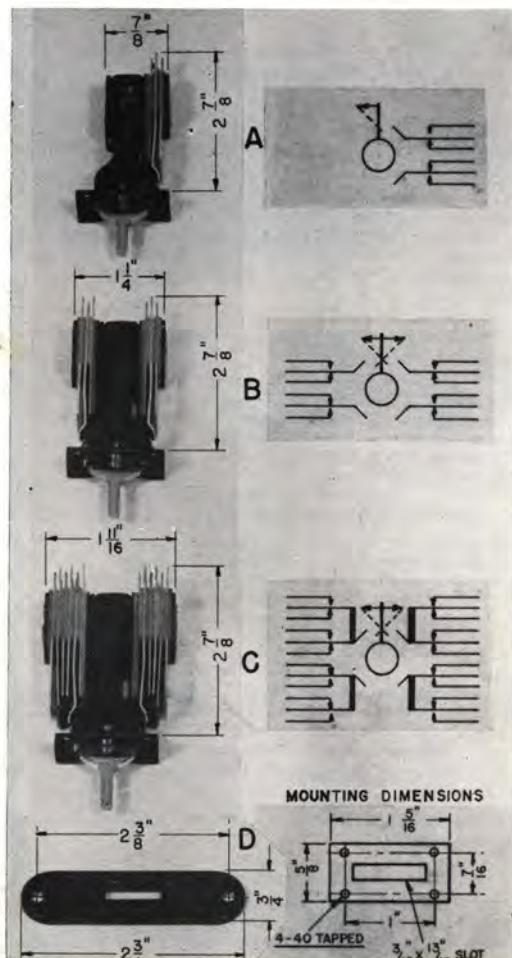

METERS — R. F., V. U., D. C. and A. C.



A



B



C

D

ORDERING INFORMATION — Most of the popular styles manufactured by Weston, Westinghouse and Burlington are carried in stock. Radio frequency ammeters are available with standard and expanded scales. The suffix EX, where indicated, means expanded scale. All RF meters have internal thermocouples. Where external thermocouples are desired, place the suffix ET after the meter type. Example: a Weston Pat. 425 meter would be 425ET for external thermocouple, 425EX for expanded scale, or 425EXET for both. As all meters are available in a wide range of values, ordering is done by stating range, style, such as milliammeter, voltmeter, etc., and catalog number.

Weston Pat. 425 R. F. Ammeters (case style A, 3" square)

Available in ranges zero to 1, 1½, 2, 2½, 3, 4, 5, 8, 10, 15 and 20 amperes. Meets all FCC specifications for official ammeter. Available with standard and expanded scales. See top of page for ordering information.

Weston 3" radio frequency ammeter, standard scale.	Cat. 425
Same as above, but with expanded scale.	Cat. 425EX
Same as above, but with external thermocouple.	Cat. 425ET

Westinghouse Pat. RT35 R. F. Ammeters (case style A, 3" square)

Available in ranges zero to 1, 1½, 2, 3, 5, 8, 10, 15 and 20 amperes. Meets all FCC specifications for official ammeter. See ordering information above.

Westinghouse 3" radio frequency ammeter, standard scale.	Cat. RT-35
Same as above, but with expanded scale.	Cat. RT-35EX
Same as above, but with external thermocouple.	Cat. RT-35ET

Weston Pat. 743 R. F. Ammeters (case B, 4" square)

These meters have frequency error less than 1% up to 50 mc. Available in ranges zero to 1, 1½, 2, 2½, 3, 4, 5, 6, 7½, 8, 10, 15 and 20 amperes. See ordering information above.

Weston 4" radio frequency ammeter, standard scale.	Cat. 743
Same as above, but with expanded scale.	Cat. 743EX
Same as above, but with external thermocouple.	Cat. 743ET

Westinghouse Pat. RT-37 R. F. Ammeters (case B, 4")

Available in ranges 1, 1½, 2, 3, 5, 8, 10, 15 and 20 amperes. See ordering information above. Meets all FCC requirements for official meter.

Westinghouse 4" radio frequency ammeter, standard scale.	Cat. RT-37
Same as above, but with expanded scale.	Cat. RT-37EX
Same as above, but with external thermocouple.	Cat. RT-37ET

Weston VU Meters (case C for 3" and case D for 4")

Available in 3" and 4" square case. Scale B, which is standard in broadcast service. Scale background in buff. Type 862 is 4" size and illuminated. Type 301 is 3" size, non-illuminated.

Weston 4" illuminated VU meter.	Cat. 862
Weston 3" VU meter.	Cat. 301

Burlington VU Meters

These quality meters are available in 3" and 4" square case models, similar to illustrations C and D above. 4" type is illuminated. Scale B, buff background.

Burlington 4" VU meter, illuminated scale.	Cat. 745
Burlington 3" VU meter.	Cat. 535

REMOTE READING ANTENNA METERS, EITHER THERMOCOUPLE OR RECTIFIER TYPE, WILL BE FOUND LISTED ON PAGE 62.

A. C. Voltmeters, 3" case

3" square case, style A at top of page. Ranges of zero to 5, 10, 15, 30, 50, 100, 130, 150, 250 and 500. Meets FCC scale division requirement.

For Weston, order	Cat. 476
For Westinghouse, order	Cat. RA-35
For Burlington, order	Cat. 532

D. C. Milliammeters, 3" case

These 3" square case meters, style A above, are available from three popular manufacturers. Meet FCC scale division requirements. Available in ranges zero to 1, 5, 10, 15, 20, 30, 50, 100, 150, 200, 300, 500, 800 and 1000 ma.

For Weston, order	Cat. 301
For Westinghouse, order	Cat. RX-35
For Burlington, order	Cat. 531

D. C. Voltmeters, 3" case

Three inch case, style A above. Ranges: 1500, 2000, 2500 and 3000 volts carried in stock. 1000 ohms per volt. Meter multiplier an accessory.

For Weston, order	Cat. 301
For Westinghouse, order	Cat. RX-35
For Burlington, order	Cat. 531

D. C. Milliammeters, 4" case

Case style B above. Meets FCC scale division requirements. Ranges: zero to 10, 25, 50, 100, 200, 300, 500 and 1000 ma.

For Weston, order	Cat. 741
For Westinghouse, order	Cat. RX-37
For Burlington, order	Cat. 741

A. C. Voltmeters, 4" case

Style B above. Ranges: zero to 10, 15, 20, 100, 130, 150, 250 and 300 volts. Meets FCC scale division requirements.

For Weston, order	Cat. 744
For Westinghouse, order	Cat. RA-37
For Burlington, order	Cat. 742B

D. C. Voltmeters, 4" case

Style B above. Ranges: zero to 3000, 5000, 6000 and 8000 volts. Meets FCC scale division requirements. Supplied less multipliers. 1000 ohms per volt.

For Weston, order	Cat. 741
For Westinghouse, order	Cat. RX-37
For Burlington, order	Cat. 741-B

Meter Multipliers for DC Voltmeters

For use with any DC voltmeter listed on this page. Current rating 1 ma. Highly accurate and made of Nichrome and advance enamel. .0015" diameter minimum. Fit form No. 1 fuse clips. Type MFA is 9¼" long. Type MFB 5½" long. When ordering multipliers remember each 1000 volts requires 1 megohm; example, 0-2000 voltmeter would require 2 meg multiplier.

Multiplier for 1500 voltmeter.	Cat. MFB-155
Multiplier for 2000 voltmeter.	Cat. MFB-205
Multiplier for 2500 voltmeter.	Cat. MFB-255
Multiplier for 3000 voltmeter.	Cat. MFB-305
Multiplier for 5000 voltmeter.	Cat. MFA-505
Multiplier for 6000 voltmeter.	Cat. MFA-605

PLEASE ORDER METERS BY RANGE, PURPOSE, MAKE AND CATALOG NUMBER.

METER SWITCHES, BLOWER, TUBE SOCKETS, PRESSURE CONTROL

MO-3823 Meter Switch

Designed for high current and high voltages common in antenna circuits up to 50 and 100 kw transmitters. Current rating 40 amperes. This meter switch is double pole triple throw with make before break action. All electrical parts silver plated. End castings are aluminum and insulators Alsimag. Shaft insulator in illustration is extra equipment. Size over-all: 11 5/8" long, 7" wide, 8" high. Mounting dimensions: 10 3/4" x 6".

Meter Shorting Switch. Cat. MO-3823

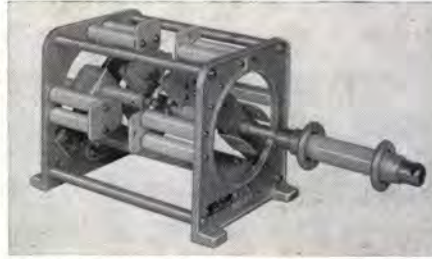

MO-3863 Meter Switch

Recommended for medium powers, the Gates MO-3863 meter shorting switch may be used up to 15 amperes. Has D.P.D.T. make before break action. All electrical parts silver plated and switch is supplied with mounting insulators and handle. Over-all size: 5 1/2" x 5 1/2" x 2 1/4". Mounting center 1 3/4" x 4 1/2".

Meter Shorting Switch. Cat. MO-3863

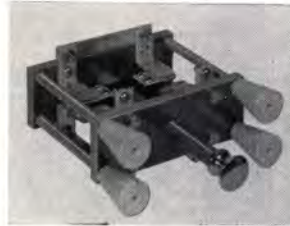

Reciprocating Solenoid Relay

Has many uses in electronic circuits, especially in switching of antenna circuits in directional arrays. By elimination of knife or ball socket contacts in favor of a heavy wiping contact operation, it is positive electrically and will not jam. Has D.P.D.T. action. All electrical parts silver plated. Insulators of Alsimag. May be had for 50 cycles on special order. Over-all size: 8 1/2" wide, 7 1/2" long, 4 3/4" high.

Solenoid Relay, 220 volts, 60 cycles.

Cat. MO-3480A

Solenoid Relay, 115 volts, 60 cycles.

Cat. MO-3480B

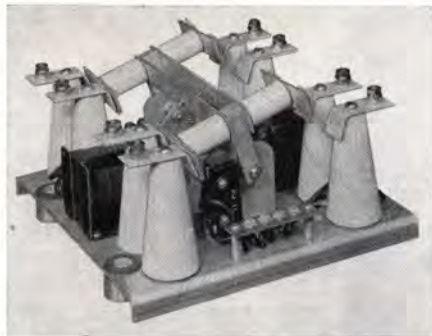

Plug-in Metering

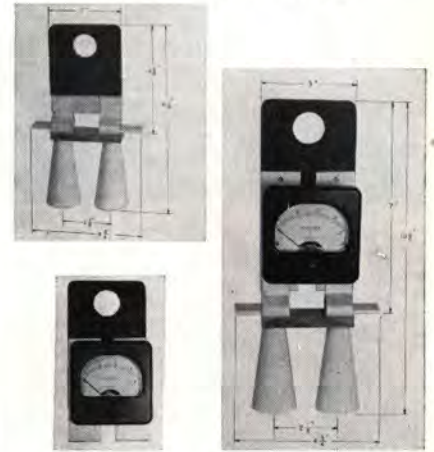

In antenna circuits, as well as other applications, this plug-in meter kit is necessary to provide economical use of meters. It is also unsurpassed for lightning protection. Above, right, is the complete assembly. MO-3280 consists of meter mounting base with clips and shorting bar. MO-3281 is the meter mounting plug. Meter may be any 3" square case type. Meter is not supplied.

Meter base with shorting bar. Cat. MO-3280

Meter mounting plug. Cat. MO-3281

Tube Socket

(3X2500)

For use with Elmac 3X2500 or 3X2500F3 tubes. Top and bottom castings of machined aluminum. Center portion, glazed white wet process porcelain. Properly designed for full air flow through center of socket to cooling fins of tubes. Size: 8 1/8" high and 4 3/4" diameter.

Tube socket. Cat. MO-3934



Tube Socket

(for 889R, 891R, 892R)

Base casting of aluminum. Top, spun copper chrome plated. Center, glazed white wet process porcelain. Size: 8 3/4" high and 9 3/7" diameter. A well built, carefully machined transmitting tube socket for best commercial application.

Tube socket. Cat. MO-3933



Static Pressure Control



Designed for applications where very low pressure exists. Used in most Gates transmitters where a blower is employed in air cooling of power tubes. Diaphragm, activated by air pressure, engages switch. Failure of air for any cause will disengage switch, turning off high voltage and preventing damage to tubes. — Rating is based in inches of water. Example: for 3 or 4 type 3X2500 tubes a rating of 1.4" suggested. Smaller tubes, lower pressure.

Pressure switch, for 0.25" water. Cat. 104A

Same as above, for 0.5" water. Cat. 104B

Same as above, for 0.7" water. Cat. 104C

Same as above, for 1.0" water. Cat. 104D

Same as above, for 1.4" water. Cat. 104E

Power Tube Blower



A large squirrel cage blower, quiet in operation, for cooling one or several power tubes. Ample to cool up to four 3X2500 tubes. 1750 RPM, 220 volts, 60 cycles, 3 phase. Will operate on 50 cycles with lower motor speed and proportionately reduced air flow. Rating 800 CFM at 1.75" static pressure. Upblast discharge, clockwise rotation. Built to NEMA standards. Single seal, grease cup lubricated motor. Size: 23" high, 23" deep, 24" wide.

Blower complete with motor.

Cat. BC25

FOR QUICK SERVICE—Use These Gates Offices

City	Address	Phone
New York, N. Y.	51 E. 42nd St.	Murray Hill 7-7971
Washington, D. C.	Warner Bldg.	Metropolitan 8-0522
Houston, Texas	2700 Polk Ave.	Atwood 8536
New York (export)	13 E. 40th St.	Murray Hill 9-0200
Quincy, Ill.	123 Hampshire St.	8202

A Gates Sales Engineer is near you, no matter where you are. All Gates sales personnel are employed directly by the Gates Company. Their one and entire purpose is to serve you with Gates manufactured and distributed products. If you need a sales engineer quickly, write, wire, or phone the office nearest you, or our main office at Quincy, Ill.

FEDERAL TRANSMITTING TUBES

POWER TRIODES—AIR COOLED

TYPE	PRICE	DESCRIPTION	Maximum Plate Dissipation	Mu	Maximum Plate Input	Maximum DC Plate Voltage	Maximum Frequency for Maximum Ratings	Filament Voltage
F-123-A	SEE GATES PUBLISHED PRICE LIST FOR TUBE PRICES	R.F. Amplifier	125 W	14.5	375 W	2,000	30 MC	10
F-127-A		General Purpose	200	38	950	3,000	30	10
F-204-A		Oscillator, R. F. Amp. or Modulator	250	23	690	2,500	3	11
F-212-E		General Purpose	275	16	700	2,000	4.5	14
F-849		General Purpose	400	19	875	2,500	3.0	11
F-450TH		General Purpose	450	38	3 KW	6,000	40	7.5
F-128-A		Oscillator or R.F. Amplifier	600	36	3	3,500	30	11
F-132-A		Audio Amplifier	600	10	1.8	3,500		11
F-7C26		H.F. Amplifier	1 KW	17	3	3,000	150	9.0
F-7C23		Pulse	1.2	25		17,000	5	11.0
F-5680		Pulse	1.2	25		17,000	5	13.0
"		R.F. Amplifier	2.5	25	12	6,000	5	13.0
F-7C25		Industrial	2.5	25	5.6	4,500	50	11
F-3X2500		H.F. Amplifier	2.5	20	8	4,000	110	7.5
*F-891-R		Modul'r or R.F. Amp.	4	8	15	10,000	1.6	11/22
*F-892-R		R.F. Amplifier or Modulator	4	50	18	10,000	1.5	11/22
*F-129-R		High Frequency R.F. Amplifier	5	26	18	12,000	30	18
*F-889-RA		R.F. Amplifier and Modulator	5	21	16	8,500	25	11
F-5667		Industrial, R.F. Ampl'r or Modulator	7.5	21	20	10,000		11.0
F-8C25		Audio Amplifier	5	5.75	10	5,000		7
*F-124-R	General Purpose	20	42	100	20,000	20	13.6 per section	
*F-9C31	General Purpose	20	42	100	15,000	20	7.5 per section	
*F-9C29	Audio Amplifier	20	4.75	50	15,000		7.5 per section	
*F-893-AR	General Purpose	20	36	70	20,000	5	10 per section	
F-8002-R	General Purpose	1.2	21.5	3	3,500	120	16	

*Credit toward purchase of renewal tubes allowed for return of radiator and crate in good condition as follows: in case of F-129-R, F-889-RA \$30.00 in case of F-891-R and F-892-R, \$45.00; in case of F-124-R, F-893-AR, F-9C29 ad F-9C31, \$150.00

RECTIFYING TUBES

TYPE	PRICE	DESCRIPTION	Maximum Peak Inverse Voltage	Maximum Peak Current (Amperes)	Filament Voltage
F-872-A	SEE PRICE LIST FOR TUBE PRICES	Mercury Vapor	10,000	5	5
F-315-A		Mercury Vapor	15,000	6	5
F-575-A		Mercury Vapor	15,000	6	5
F-869-B		Mercury Vapor	20,000	10	5
F-857-B		Mercury Vapor	22,000	40	5
F-266-B		Mercury Vapor	22,000	40	5
F-873		Grid Controlled Mercury Vapor	10,000	10	5
F-5563		Grid Controlled Mercury Vapor	15,000	6.4	5
F-222-A		Water Cooled - High Vacuum	50,000	5.5	21.5

OTHER TUBES NORMALLY CARRIED IN STOCK

As manufacturers, as well as distributors of radio tubes, we carry a large stock of all late and earlier design tubes. The tubes listed below, plus many others, are normally carried in stock. Receiving type tubes are not listed, but are stocked and available at the lowest established price.

802	807	813	838	872A	892R
803	810	814	845	885	8008
805	811A	828	849	889R	673
806	812A	833A	866A	891R	

If You Didn't Get This From My Site,
Then It Was Stolen From...

EIMAC TRANSMITTING TUBES

For fast delivery to you, these tubes are carried in generous quantity in our Quincy, Ill., Houston, Texas, and Atlanta, Ga., stock distributing points. Known the world over as long life, uniform and top performing tubes, Eimac Tubes are recommended highly by the Gates Engineering Department.

TRIODES



TYPE	DESCRIPTION	MAXIMUM DIMENSIONS		FILAMENT		TRANSCONDUCTANCE μmhos	CLASS OF SERVICE	Max. Frequency Full Rating Mc.	MAX. PLATE RATINGS			TYPICAL OPERATING CONDITIONS						
		Length Inches	Diameter Inches	Volts	Amps.				DC Volts	DC Amps	Dissipation Watts	DC Plate Volts	DC Grid Volts	Peak A.F. Grid Input Volts Per Tube	DC Plate Amps	Plate Load Ohms	Driving Power Watts	Power Output Watts
2C39A	Forced-air cooled, planar UHF triode. Oxide coated cathode, external anode. Operates as power amplifier, multiplier, and oscillator to 2500 Mc.	2.75	1.26	6.3	1.0	22,000	C CW	2,500	1,000	.125†	100	800	-20080	...	6	27
									600	.100†	70	600	-16075	...	6	18
3W5000A3 3W5000F3	5-Kw. water cooled, general purpose, high transconductance triode. See Note 2.	8.0**	3.0	7.5	51.0	20,000	B Aud		6,000	2.5	5,000	6,000	-240	390	.4/3.0	4,650	115	13,000
							C CW	A 75 F 30	6,300	2.5	5,000	6,000	-500	208	136	10,000
							AM PI	A 75 F 30	5,000	2.0	3,350	5,000	-550	...	1.45	...	76	5,580
3W10000A3	10-Kw., water-cooled, high transconductance triode. Unipotential thoriated tungsten cathode, non-emitting grid, external anode. Concentric VHF terminals.	13.0**	5.0	10.0†	30.0	55,000	B TV	220	5,000	10	10,000	3,250	-190	...	4.25	560	400	5,500*
3X2500A3 3X2500F3	2.5-Kw. forced-air cooled, general purpose, high transconductance triode. See Note 2.	9.0	4.16	7.5	51.0	20,000	B Aud	...	6,000	2.5	2,500	6,000	-240	390	.4/3.0	4,650	113	13,000
							C CW	A 40 F 30	6,000	2.5	2,500	6,000	-500	...	2.08	...	136	10,000
							C CW	A 110	4,000	2.0	2,500	4,000	-500	...	1.85	...	1,900	7,500*
							AM PI	A 40 F 30	5,000	2.0	1,670	5,000	-550	...	1.45	...	76	5,580
3X3000A1 3X3000F1	3-Kw., forced-air cooled, low-μ power triode, intended for use as an audio amplifier or modulator. See Note 2.	9.0	4.16	7.5	51.0	11,000	B Aud	...	6,000	2.5	3,000	6,000	-1300	1250	.335/2.65	4,560	...	16,000
6C21	High-vacuum, radiation cooled, pulse modulator triode. Thoriated tungsten filament, non-emitting grid, pyrovac plate.	12.63	5.13	8.2	16.8	5,800	Pulse Mod	30,000	15	300	27,000	-1500	3100	15	1,600
25T	25-watt plate dissipation, radiation cooled, general purpose triode. Thoriated tungsten filament, non-emitting grid, pyrovac plate.	4.38	1.44	6.3	3.0	2,500	B Aud	2,000	.075	25	1,250	-42	135	.024/.130	21,400	3.4	112
							C CW	60	2,000	.075	25	2,000	-130063	...	4	100
							AM PI	60	1,600	.060	17	1,600	-170053	...	3.1	68
35T 35TG	50-watt plate dissipation, radiation cooled, general purpose triode. Thoriated tungsten filament, non-emitting grid, pyrovac plate.	5.5	1.81	5.0	4.0	2,850	B Aud	2,000	.150	50	2,000	-40	130	.034/.167	27,500	4	235
							C CW	100	2,000	.150	50	2,000	-135125	...	13	200
							AM PI	100	1,600	.120	33	1,500	-150090	...	11	105
75TH 75TL	75-watt plate dissipation, radiation cooled, general purpose triode. Thoriated tungsten filament, non-emitting grid, pyrovac plate. H version high-μ, L version low-μ.	7.25	2.81	5.0	6.25	H 4,150 L 3,350	B Aud	3,000	.225	75	2,000	H -90 L -190	175 300	.050/.225 .050/.250	19,300 18,000	3 5	300 350
							C CW	40	3,000	.225	75	2,000	H -200 L -300150	...	10 8	225
							AM PI	40	2,400	.180	50	2,000	H -300 L -500110 .130	...	6 14	170 210
100TH 100TL	100-watt plate dissipation, radiation cooled, general purpose triode. Thoriated tungsten filament, non-emitting grid, pyrovac plate. H version high-μ, L version low-μ.	7.75	3.19	5.0	6.3	H 4,500 L 3,000	B Aud	3,000	.225	100	2,500	H -50 L -145	155 290	.060/.280 .048/.250	22,000	7.5 10	425
							C CW	40	3,000	.225	100	3,000	H -200 L -400165	...	18 20	400
							AM PI	40	2,500	.180	65	2,500	H -250 L -500140	...	17 23	285

See page 5 for explanation of class of service symbols.

* Typical operation, grounded grid at full rating.

**Does not include water couplings.

Note 2: Thoriated tungsten filament, non-emitting grid, external anode.
A Concentric VHF terminals. F Flexible lead terminals.

† Bombardment heated cathode, requires 1600v. DC at 1.9 amps.

‡ Cathode Current

BASING



6C21



25T



35T



35TG
75TH
75TL
100TH
100TL

SPECIAL

2C39A
3W5000A3
3W5000F3
3W10000A3
3X2500A3
3X2500F3
3X3000A1
3X3000F1

EIMAC TRANSMITTING TUBES

TETRODES · PENTODES



TETRODES		MAXIMUM DIMENSIONS		FILAMENT		TRANSCONDUCTANCE μmhos	CLASS OF SERVICE	Max. Frequency Full Rating Mc.	MAX. PLATE RATINGS			TYPICAL OPERATING CONDITIONS						
TYPE	DESCRIPTION	Length Inches	Diameter Inches	Volts	Amps				DC Volts	DC Amps	Dissipation Watts	DC Plate Volts	DC Screen Volts	DC Grid Volts	DC Plate Amps	Plate Load Ohms	Driving Power Watts	Power Output Watts
4-65A	65-watt plate dissipation, radiation cooled, general purpose radial-beam power tetrode. See Note 1.	4.38	2.38	6.0	3.5	4,000	B Aud	...	3,000	.150	65	1,800	250	-35	.050/.220	20,000	1.1	270
							C CW	150	3,000	.150	65	3,000	250	-90	.115	...	1.7	280
							AM PI	150	2,500	.120	45	2,500	250	-150	.108	...	1.9	225
4-125A	125-watt plate dissipation, radiation cooled, general purpose radial-beam power tetrode. See Note 1.	5.69	2.87	5.0	6.5	2,450	B Aud	...	3,000	.225	125	2,500	350	-43	.093/.260	22,200	2.4	400
							C CW	120	3,000	.225	125	3,000	350	-150	.167	...	2.5	375
							AM PI	120	2,500	.200	85	2,500	350	-210	.152	...	3.3	300
4-250A	250-watt plate dissipation, radiation and forced-air cooled, general purpose radial-beam power tetrode. See Note 1.	6.38	3.56	5.0	14.5	4,000	B Aud	...	4,000	.350	250	3,000	300	-53	.125/.473	16,000	1.9	1,040
							C CW	110	4,000	.350	250	4,000	500	-225	.312	...	2.5	1,000
							AM PI	110	3,200	.275	165	3,000	400	-310	.250	...	3.5	585
4-400A	400-watt plate dissipation, radiation and forced-air cooled, general purpose radial-beam power tetrode. See Note 1.	6.38	3.56	5.0	14.5	4,000	B Aud	...	4,000	.350	400	4,000	500	-90	.120/.638	14,000	3.5	1,750
							C CW	110	4,000	.350	400	4,000	500	-220	.350	...	6	1,100
							C CW	110	4,000	.350	400	4,000	400	-170	.270	...	10	720 +
							AM PI	110	3,200	.275	270	3,000	400	-310	.275	...	4	640
4-1000A	1000-watt plate dissipation, radiation and forced-air cooled, general purpose radial-beam power tetrode. See Note 1.	9.63	5.25	7.5	21.0	10,000	B Aud	...	6,000	.700	1,000	6,000	500	-75	.150/.950	15,000	4.7	3,900
							C CW	110	6,000	.700	1,000	6,000	500	-200	.700	...	15	3,400
							C CW	110	6,000	.700	1,000	6,000	500	-180	.625	...	200	2,600 +
							AM PI	30	5,500	.600	670	5,500	500	-200	.600	...	9	2,630
4PR60A	High-vacuum, radial-beam, pulse modulator tetrode. Oxide cathode internal anode. Unilateral replacement for 715B, 715C, and 5D21.	6.0	3.06	26.0	2.2	90,000	Pulse Mod	...	20,000	18	60	20,000	1,250	-800	15
4W20000A	20 Kw., water-cooled, high transconductance radial beam, power tetrode. Unipotential thoriated-tungsten cathode, non-emitting grid, external anode. Concentric VHF terminals.	12.0**	5.0	10.0†	30.0	75,000	B TV	220	8,000	(avg.) 15	20,000	5,500	1,200	-240	7.1	20,100*
C CW	220	8,000	15	20,000	7,000	1,200	-400	3.4	...	830	13,000 +							
4X150A 4X150D	150-watt plate dissipation, forced-air cooled, general purpose, high transconductance radial-beam power tetrode. Oxide coated cathode, external anode. Operates in normal amplifier service through 500 Mc.	2.47	1.65	A 6.0 D 26.5	2.6 0.57	12,000	B Aud	...	1,250	.250	150	1,250	300	-44	.180/.475	5,600	0.075	425
							B TV	500	1,250	(avg.) .250	150	1,250	300	-70	.305	250*
							C CW	500	1,250	.250	150	1,250	250	-90	.200	...	1.2	195
							C CW	500	1,250	.250	150	1,250	280	-115	.200	...	30	140+
AM PI	500	1,000	.200	100	1,000	250	-105	.200	...	1.1	145							
4X150G	150-watt plate dissipation, forced-air cooled, general purpose radial-beam power tetrode. Oxide coated cathode, external anode. Concentric UHF terminals. Operates up through 1000 Mc.	2.63	1.65	2.5	6.25	12,000	C CW	750	1,250	.250	150	1,250	250	-60	.200	...	9	100 +
							Plate Pulse	1,200	7,000	*	150	7,000	1,000	-250	6.0	20,000 +
4X500A 4X500F	500-watt plate dissipation, forced-air cooled, general purpose radial-beam power tetrode. Thoriated tungsten filament, non-emitting grids, external anode.	A 4.75 F 5.13	2.63	5.0	13.5	5,200	C CW	110	4,000	.350	500	4,000	500	-250	.315	...	13	980 +
							B TV	220	3,000	.350	500	2,400	500	-100	.400	3,000	25	600 +
							C CW	110	4,000	.350	500	4,000	500	-250	.315	...	13	980 +

PENTODE

4E27A/5-125B	125-watt plate dissipation, radiation cooled, general purpose radial-beam power pentode. See Note 1.	6.19	2.75	5.0	7.5	2,150	B Aud	...	4,000	.200	125	2,500	500	-85	.065/.250	20,000	.2	400
							C CW	75	4,000	.200	125	3,000	500	-200	.167	...	2	375
							AM PI	75	3,200	.160	85	2,500	500	-200	.152	...	2	295

See page 5 for explanation of class of service symbols.

Note 1: Thoriated tungsten filament, non-emitting grids, pyrovac plate.

* Max. pulsed cathode current 7 amps, Max. pulse duration 5 microseconds.

** Does not include water couplings.

† Typical operation at maximum frequency for full rating.

‡ Bombardment heated cathode, requires 1600v DC at 1.9 amps.

* Peak synchronizing level.

BASING

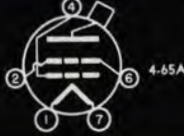

SPECIAL

4X150A
4X150D
4X150G
4X500A
4W20000A

EIMAC TRANSMITTING TUBES

TRIODES · KLYSTRONS

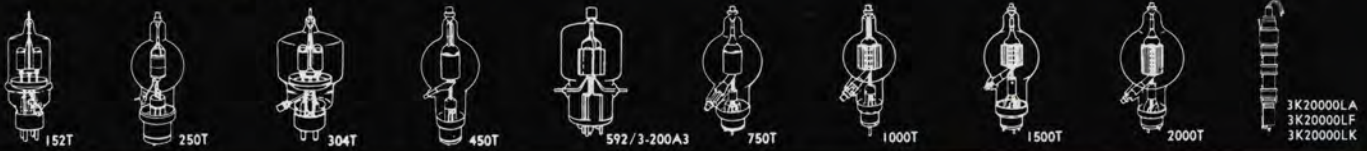

TRIODES

TYPE	DESCRIPTION	MAXIMUM DIMENSIONS		FILAMENT		TRANSDUCTANCE μmhos	CLASS OF SERVICE	Max. Frequency Full Rating Mc.	MAX. PLATE RATINGS			TYPICAL OPERATING CONDITIONS							
		Length Inches	Diameter Inches	Volts	Amps.				DC Volts	DC Amps	Dissipation Watts	DC Plate Volts	DC Grid Volts	Peak A.F. Grid Input Volts Per Tube	DC Plate Amps.	Plate Load Ohms	Driving Power Watts	Power Output Watts	
152TH 152TL	150-watt plate dissipation, radiation cooled, general purpose triode. Thoriated tungsten filament, non-emitting grid, pyrovac plate. H version high-mu, L version low-mu.	7.63	2.56	5 or 10	12.5 or 6.25	H 8,300 L 7,150	B Aud	3,000	.450	150	3,000	H -150 L -260	430 675	.067/.335 .100/.500	20,300 20,400	3	700	
								C CW	40	3,000	.450	150	3,000	H -300 L -400250	...	27 20	600
								AM PI	40	2,500	.350	100	2,000	H -300 L -550250	...	30 25	400
250TH 250TL	250-watt plate dissipation, radiation cooled, general purpose triode. Thoriated tungsten filament, non-emitting grid, pyrovac plate. H version high-mu, L version low-mu.	10.13	3.81	5.0	10.5	H 5,600 L 2,650	B Aud	4,000	.350	250	3,000	H -65 L -170	260 400	.100/.560 .100/.500	12,250 13,000	42 16	1,180 1,000	
								C CW	40	4,000	.350	250	4,000	H -220 L -500313	...	39 33	1,000
								AM PI	40	3,000	.280	165	3,000	H -200 L -520200	...	14 11	435
304TH 304TL	300-watt plate dissipation, radiation cooled, general purpose triode. Thoriated tungsten filament, non-emitting grid, pyrovac plate. H version high-mu, L version low-mu.	7.63	3.56	5 or 10	25 or 12.5	16,700	B Aud	3,000	.900	300	3,000	H -150 L -290	210 390	.134/.667 .130/.800	10,200 9,100	6 55	1,400 1,800	
								C CW	40	3,000	.900	300	3,000	H -300 L -400500	...	53 40	1,200
								AM PI	40	2,500	.700	200	2,500	H -400 L -550450	...	50 40	925
450TH 450TL	450-watt plate dissipation, radiation cooled, general purpose triode. Thoriated tungsten filament, non-emitting grid, pyrovac plate. H version high-mu, L version low-mu.	12.63	5.13	7.5	12.0	H 6,650 L 5,000	B Aud	6,000	.600	450	5,000	H -115 L -240	267 430	.120/.620	18,600 18,500	10 28	2,200	
								C CW	40	6,000	.600	450	5,000	H -300 L -500450	...	46 42	1,800
								AM PI	40	4,500	.500	300	4,500	H -400 L -550345	...	35 31	1,250
592/3-200A3	200-watt plate dissipation, radiation cooled, general purpose triode. Thoriated tungsten filament, non-emitting grid, pyrovac plate.	6.0	3.41	10.0	5.0	3,600	B Aud	3,500	.250	200	3,000	-90	270	.080/.400	18,000	20	820	
								C CW	150	3,500	.250	200	3,500	-270228	...	15	600
								AM PI	150	2,600	.200	130	2,500	-300200	...	19	375
750TL	750-watt plate dissipation, radiation cooled, general purpose triode. Thoriated tungsten filament, non-emitting grid, pyrovac plate.	17.0	7.13	7.5	21.0	3,500	B Aud	10,000	1.0	750	6,000	-390	650	.166/.834	16,300	46	3,500	
								C CW	40	10,000	1.0	750	6,000	-700625	...	125	3,000
								AM PI	40	8,000	.8	500	6,000	-950415	...	75	2,000
1000T	1000-watt plate dissipation, radiation and forced-air cooled, general purpose triode. Thoriated tungsten filament, non-emitting grid, pyrovac plate.	12.3	5.13	7.5	15.5	9,050	B Aud	7,500	.750	1,000	6,000	-160	335	.220/1.05	13,300	60	4,600	
								C CW	50	7,500	.750	1,000	6,000	-350667	...	60	3,000
								AM PI	50	6,000	.600	665	6,000	-500600	...	75	2,935
1500T	1500-watt plate dissipation, radiation and forced-air cooled, general purpose triode. Thoriated tungsten filament, non-emitting grid, pyrovac plate.	17.0	7.13	7.5	24.0	10,000	B Aud	8,000	1.25	1,500	6,000	-190	570	.330/1.65	8,200	115	7,000	
								C CW	40	8,000	1.25	1,500	7,000	-500860	...	85	4,500
								AM PI	40	6,000	1.00	1,000	6,000	-750835	...	120	4,000
2000T	2000-watt plate dissipation, radiation and forced-air cooled, general purpose triode. Thoriated tungsten filament, non-emitting grid, pyrovac plate.	17.75	8.13	10.0	23.5	11,000	B Aud	8,000	1.75	2,000	7,000	-280	600	.300/1.80	9,200	175	8,600	
								C CW	40	8,000	1.75	2,000	7,000	-600	...	1.15	...	115	6,000
								AM PI	40	6,000	1.40	1,350	6,000	-800	...	1.13	...	225	5,400

KLYSTRONS		MAXIMUM DIMENSIONS		FILAMENT		FREQUENCY RANGE Mc.	MAXIMUM RATINGS			CLASS OF SERVICE	TYPICAL OPERATING CONDITIONS										
TYPE	DESCRIPTION	Length Inches	Diameter Inches	Volts	Amps		Beam DC Volts	Collector DC Amps	Dissipation Watts		Beam DC Volts	DC Amps	Driving Power Watts	Power Output Watts							
3K20000LA 3K20000LF 3K20000LK	3 gap 20-KW. Collector dissipation, water and forced-air cooled Klystron for use in UHF TV band. Use of external cavities provides coverage of entire band with three versions of the tube.	A 50.5 F 44.0 K 36.75	5.69 5.69 5.69	9.0†	42.0	A 470-580 F 580-720 K 720-890	13,500	1.7	20,000	B TV C CW	13,000 10,000	1.5 1.0	100 approx.	5,000*							
†Cathode bombardment power, 1600 watts (2100 Vdc, 0.75A)													10 approx.	2,500							
* Peak synchronizing level.																					

BASING



SPECIAL

3K20000LA
3K20000LF
3K20000LK

EIMAC TRANSMITTING TUBES — VACUUM CAPACITORS

RECTIFIERS · VACUUM CAPACITORS



HIGH VACUUM RECTIFIERS

TYPE	DESCRIPTION	MAXIMUM DIMENSIONS		AVERAGE PLATE CUR. Ma.	PLATE DISSIPATION Watts	PEAK INVERSE VOLTAGE Volts	FILAMENT	
		Length Inches	Diameter Inches				Volts	Amps.
2-01C	General purpose UHF instrument diode. Accurate to 700 Mc. 5-volt oxide coated cathode. Resonant frequency 2800 Mc. Suited to probe mounting.	1.81	.563	1	0.1	1,000	5.3	0.4
2-25A	High vacuum rectifier. High voltage, medium current. Instant heating, thoriated tungsten filament. Radiation cooled pyrovac plate.	4.38	1.44	50	15	25,000	6.3	3.0
2-50A	High vacuum rectifier. High voltage, medium current. Instant heating, thoriated tungsten filament. Radiation cooled pyrovac plate.	5.50	1.82	75	30	30,000	5.0	4.0
2-150D	High vacuum rectifier. High voltage medium current. Instant heating, thoriated tungsten filament. Radiation cooled pyrovac plate.	8.88	2.50	250	90	30,000	5.0	13.0
2-240A	High vacuum rectifier. High voltage, high current. Instant heating, thoriated tungsten filament. Radiation cooled pyrovac plate.	11.2	3.82	500	150	40,000	7.5	12.0
2-2000A	High vacuum rectifier. High voltage, high current. Instant heating, thoriated tungsten filament. Radiation cooled pyrovac plate.	17.8	8.13	750	1,200	75,000	10.0	25.0
250R	High vacuum rectifier. High voltage, medium current. Instant heating, thoriated tungsten filament. Radiation cooled pyrovac plate.	10.13	3.82	250	150	60,000	5.0	10.5
253	High vacuum rectifier. High current. Instant heating, thoriated tungsten filament. Radiation cooled pyrovac plate.	8.75	2.50	350	100	15,000	5.0	10.0
8020/100R	High vacuum rectifier. High voltage, medium current. Instant heating, thoriated tungsten filament. Radiation cooled pyrovac plate.	8	2.32	100	60	40,000	5.0	6.5

MERCURY VAPOR TYPES

Peak Plate Amps.

TYPE	DESCRIPTION	Length Inches	Diameter Inches	Average Plate Cur. Ma.	Plate Dissipation Watts	Peak Inverse Voltage Volts	Filament Volts	Filament Amps.
KY21A	Grid-controlled, mercury vapor rectifier. 2.5-volt, oxide coated filament. 750-Ma. average plate current.	7.69	2.25	750	3	11,000	2.5	10.0
RX21A	Mercury vapor rectifier. 2.5-volt, oxide coated filament. 750-Ma. average plate current.	7.63	2.25	750	3	11,000	2.5	10.0
866A	Mercury vapor rectifier. 2.5 volt, oxide coated filament. 250-Ma. average plate current.	6.5	2.5	250 500	1 2	10,000 2,000	2.5	5.0
872A	Mercury vapor rectifier. 5.0-volt, oxide coated filament. 1.25 amperes average plate current.	8.5	2.31	1,250	5	10,000	5.0	7.5

VACUUM CAPACITORS

FIXED TYPE

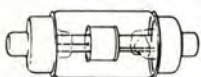

Eimac vacuum capacitors are small, vacuum-dielectric units intended principally for use as all or part of the plate tank capacitance. They are also frequently used as high-voltage coupling and by-pass capacitors at high frequencies and as high-voltage neutralizing capacitors. Overall length 6 3/4", diameter 2 1/4".

TYPE	VC6-20	VC6-32	VC12-20	VC12-32	VC25-20	VC25-32	VC50-20	VC50-32
Capacitance μfd	6	6	12	12	25	25	50	50
Max. Peak volts	20,000	32,000	20,000	32,000	20,000	32,000	20,000	32,000
Max. RMS amps.	28	28	28	28	28	28	28	28

VARIABLE TYPE

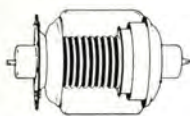

Eimac variable vacuum capacitors are intended principally for use as plate tank capacitors in radio frequency amplifiers and oscillators. The capacitance variation is linear with respect to shaft rotation and return to previously indexed settings is positive. The low-torque tuning mechanism is designed with adequate bearing surfaces to provide long life.

TYPE	MAX. DIMENSIONS			CAPACITANCE		Max. Peak RF Voltage		Max. RMS Current	
	Length	Height	Width	μfd		Volts		Amps	
VVC60-20	5.69	...	3.06	10-60		20,000		40	
VVC2-60-20	6.28	3.13	8.13	Parallel 20-120	Split Stator 5-30	Parallel 20,000	Split Stator 40,000	Parallel 80	Split Stator 40
VVC4-60-20	6.28	7.81	7.81	40-240	10-60	20,000	40,000	160	80



JENNINGS VACUUM CAPACITORS

CAPACITY MFD.	PEAK IN KILOVOLTS	RMS AMPERES		MOUNTING CENTERS	CATALOG NO.	
		NICKEL	COPPER		COPPER	NICKEL
6, 12, 25, 50, 75, 100, 150 FIXED	20, 30	14	60	5 13/16	VCC	VC
200, 250 FIXED	20, 30	14	60	5 7/8	VCC	VC
500, 750, 1000 FIXED	10, 15, 20	21	60	6 1/4	MC	M
10-50, 15-75 VARIABLE	20, 25, 30	10 1/2	-	4 3/16	-	AT
10-375 - VARIABLE	7 1/2, 10, 15	-	42	4 5/8	UCS	-
25-500 VARIABLE	7 1/2, 10, 15	-	42	4 13/16	UCS	-
10-75 VARIABLE	35, 45, 55, 60	21	60	6 1/2	UHC	UH
25-500 VARIABLE	10, 15, 20	21	60	7 11/16	UXC	UX
50-1000 VARIABLE	10, 15	21	100	7 3/4	VMMC	VMM
100-2000 VARIABLE	10, 15	21	125	8 5/8	VMMC	VMM
25-450 VARIABLE	35, 45, 55	21	125	8 3/4	VMMHC	VMMH

MICA CAPACITORS

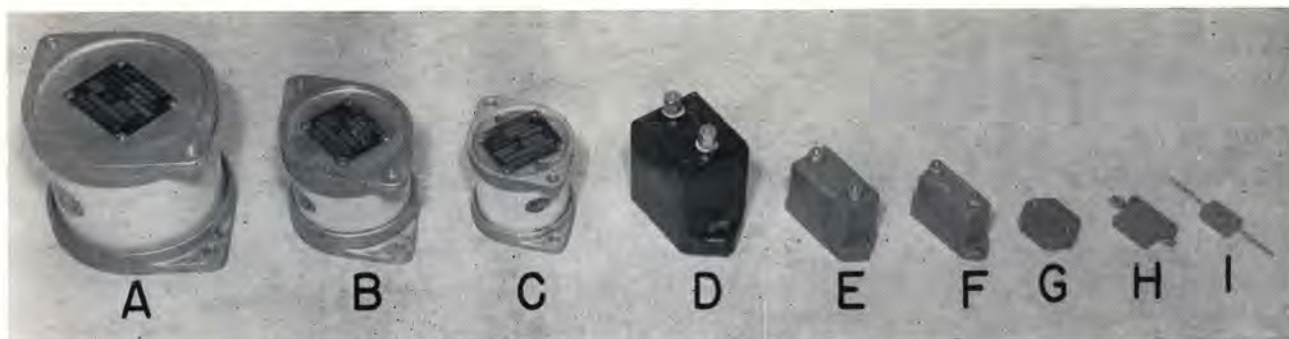

Mica Capacitors, listed on this and the next page, are manufactured by Sangamo. As we are a large user of Mica Capacitors, a substantial stock is carried. This means prompt delivery. When ordering, if you will request an optional size, as second choice, it will often assist prompt delivery.

TYPE F1 MICA CAPACITORS (Fig. F)

Catalog Number	Capacity mfd.	Peak Wkg. Volts
F1-341	.00001	3000
F1-345	.00005	3000
F1-331	.0001	3000
F1-3315	.00015	3000
F1-332	.0002	3000
F1-3325	.00025	3000
F1-333	.0003	3000
F1-334	.0004	3000
F1-335	.0005	3000
F1-336	.0006	3000
F1-3375	.00075	3000
F1-338	.0008	3000
F1-321	.001	3000
F1-3215	.0015	3000
F1-322	.002	3000
F1-3225	.0025	3000
F1-223	.003	2000
F1-224	.004	2000
F1-225	.005	2000
F1-226	.006	2000
F1-1528	.008	1500
F1-111	.01	1000
F1-112	.02	1000
F1-0215	.05	250
F1-0201	.1	250

TYPE F2 MICA CAPACITORS (Fig. E)

Catalog Number	Capacity mfd.	Peak Wkg. Volts
F2-545	.00005	5000
F2-531	.0001	5000
F2-5315	.00015	5000
F2-532	.0002	5000
F2-5325	.00025	5000
F2-533	.0003	5000
F2-534	.0004	5000
F2-535	.0005	5000
F2-536	.0006	5000
F2-5375	.00075	5000
F2-538	.0008	5000
F2-521	.001	5000
F2-5215	.0015	5000
F2-522	.002	5000
F2-5225	.0025	5000
F2-523	.003	5000
F2-424	.004	4000
F2-325	.005	3000
F2-326	.006	3000
F2-328	.008	3000
F2-211	.01	2000
F2-2115	.015	2000
F2-212	.02	2000
F2-213	.03	2000
F2-1514	.04	1500
F2-1515	.05	1500
F2-0501	.1	500
F2-0202	.2	250
F2-02025	.25	250

TYPE G1 MICA CAPACITORS (Fig. A)

Catalog Number	Capacity mfd.	Peak Wkg. Volts
G1-641	.00001	6000
G1-645	.00005	6000
G1-631	.0001	6000
G1-632	.0002	6000
G1-634	.0004	6000
G1-635	.0005	6000
G1-621	.001	6000
G1-6215	.0015	6000
G1-622	.002	6000
G1-623	.003	6000
G1-624	.004	6000
G1-625	.005	6000
G1-526	.006	5000
G1-511	.01	5000
G1-4115	.015	4000
G1-312	.02	3000

TYPE G2 MICA CAPACITORS (Fig. B)

Catalog Number	Capacity mfd.	Peak Wkg. Volts
G2-1031	.0001	10000
G2-10315	.00015	10000
G2-1032	.0002	10000
G2-10325	.00025	10000
G2-1035	.0005	10000
G2-1021	.001	10000
G2-10212	.0012	10000
G2-10215	.0015	10000
G2-1022	.002	10000
G2-823	.003	8000
G2-824	.004	8000
G2-525	.005	5000
G2-526	.006	5000
G2-511	.01	5000
G2-4115	.015	4000
G2-312	.02	3000

NOTE: Standard tolerance $\pm 5\%$, B characteristic.

TYPE F3 MICA CAPACITORS (Fig. E)

Catalog Number	Capacity mfd.	Peak Wkg. Volts	Catalog Number	Capacity mfd.	Peak Wkg. Volts
F3-8325	.00025	8000	F3-415	.05	4000
F3-835	.0005	8000	F3-201	.1	2000
F3-821	.001	8000	F3-06025	.25	600
F3-822	.002	8000	F3-0605	.5	600
F3-825	.005	8000	F3-0610	1.0	600
F3-811	.01	8000			

NOTE: Standard tolerance $\pm 5\%$, B characteristic.

TYPE E MICA CAPACITORS (Fig. D)

Catalog Number	Capacity mfd.	Test Volts D. C.	Catalog Number	Capacity mfd.	Test Volts D. C.
E-1245	.00005	12500	E-721	.001	7000
E-1231	.0001	12500	E-722	.002	7000
E-12325	.00025	12500	E-723	.003	7000
E-1235	.0005	12500	E-711	.01	7000
E-1221	.001	12500	E-3524	.004	3500
E-12215	.0015	12500	E-3525	.005	3500
E-1222	.002	12500	E-3511	.01	3500
E-1023	.003	10000	E-3512	.02	3500
E-1024	.004	10000	E-3515	.05	3500
E-1025	.005	10000	E-215	.05	2000
			E-201	.1	2000

NOTE: Standard tolerance $\pm 20\%$.

NOTE: This type capacitor is specifically designed for amateur use. It is not recommended for industrial applications.

NOTE: Packaging: Individual display carton.

TYPE G3 MICA CAPACITORS (Fig. C)

Catalog Number	Capacity mfd.	Peak Wkg. Volts
G3-2045	.00005	20000
G3-2031	.0001	20000
G3-2032	.0002	20000
G3-20325	.00025	20000
G3-2033	.0003	20000
G3-2035	.0005	20000
G3-2038	.0008	20000
G3-2021	.001	20000
G3-15215	.0015	15000
G3-1522	.002	15000
G3-1523	.003	15000
G3-1524	.004	15000
G3-1025	.005	10000
G3-1026	.006	10000
G3-1028	.008	10000
G3-1011	.01	10000
G3-512	.02	5000
G3-313	.03	3000

TYPE G4 MICA CAPACITORS (Fig. C)

Catalog Number	Capacity mfd.	Peak Wkg. Volts
G4-3043	.00003	30000
G4-3045	.00005	30000
G4-3031	.0001	30000
G4-30315	.00015	30000
G4-30325	.00025	30000
G4-3035	.0005	30000
G4-3038	.0008	30000
G4-3021	.001	30000
G4-25215	.0015	25000
G4-2022	.002	20000
G4-2023	.003	20000
G4-2024	.004	20000
G4-1525	.005	15000
G4-1526	.006	15000
G4-1228	.008	12000
G4-1011	.01	10000
G4-612	.02	6000
G4-514	.04	5000

TYPE G5 MICA CAPACITORS (Fig. C)

Catalog Number	Capacity mfd.	Peak Wkg. Volts
G5-5045	.00005	50000
G5-3531	.0001	35000
G5-35325	.00025	35000
G5-3534	.0004	35000
G5-3535	.0005	35000
G5-3521	.001	35000
G5-3022	.002	30000
G5-30225	.0025	30000
G5-3023	.003	30000
G5-2525	.005	25000
G5-2026	.006	20000
G5-1511	.01	15000

FILTER CAPACITORS — MICA CAPACITORS



To the right are listed standard oil filled filter capacitors in a wide range of capacities and voltages. Standard stock consists of Sangamo, Cornell-Dubilier and General Electric. As these capacitors are made to RTMA standard mounting dimensions, any of the above makes will be supplied — unless you state otherwise.

MICA CAPACITORS (From Page 203)

TYPE A MICA CAPACITORS

Catalog Number	Capacity mfd.	Wkg. D. C. Volts
----------------	---------------	------------------

15/32" Max. Thickness		
A-T1450	.00005	600
A-T1310	.0001	600
A-T1315	.00015	600
A-T1320	.0002	600
A-T1325	.00025	600
A-T1350	.0005	600
A-T1210	.001	600
A-T1220	.002	600
A-T1225	.0025	600
A-T1230	.003	600
A-T1240	.004	600
A-T1250	.005	600
A-T1260	.006	600
A-T1280	.008	600
A-T1110	.01	600
A-T1115	.015	600
A-T1120	.02	600
A-T1125	.025	600
A-T1130	.03	600
A-T2450	.00005	1200
A-T2310	.0001	1200
A-T2315	.00015	1200
A-T2320	.0002	1200
A-T2325	.00025	1200
A-T2350	.0005	1200
A-T2210	.001	1200
A-T2220	.002	1200
A-T2225	.0025	1200
A-T2230	.003	1200
A-T2240	.004	1200
A-T2250	.005	1200
A-T2260	.006	1200
A-T2280	.008	1200
A-T2110	.01	1200
A-T5450	.00005	2500
A-T5310	.0001	2500
A-T5315	.00015	2500
A-T5320	.0002	2500
A-T5325	.00025	2500
A-T5350	.0005	2500
A-T5210	.001	2500
A-T5220	.002	2500
A-T5225	.0025	2500
A-T5230	.003	2500
A-T5240	.004	2500

25/32" Max. Thickness		
A-K1140	.04	600
A-K1150	.05	600
A-K1160	.06	600
A-K2115	.015	1200
A-K2120	.02	1200
A-K2125	.025	1200
A-K2130	.03	1200
A-K5250	.005	2500
A-K5260	.006	2500
A-K5280	.008	2500
A-K5110	.01	2500
A-K5115	.015	2500

NOTE: Standard insulators are available if desired.

NOTE: Standard tolerance $\pm 10\%$, B characteristic. Also available at extra cost in tolerances of $\pm 5\%$ and $\pm 2\%$.

NOTE: Test voltage is exactly double the listed working voltage.

TYPE H MICA CAPACITORS

Catalog Number	Capacity mfd.	Wkg. D. C. Volts
----------------	---------------	------------------

23/64" Max. Thickness		
H-T1450	.00005	600
H-T1310	.0001	600
H-T1320	.0002	600
H-T1325	.00025	600
H-T1330	.0003	600
H-T1340	.0004	600
H-T1350	.0005	600
H-T1210	.001	600
H-T1215	.0015	600
H-T1220	.002	600
H-T1225	.0025	600
H-T1230	.003	600
H-T1240	.004	600
H-T1250	.005	600
H-T1260	.006	600
H-T1270	.007	600
H-T1280	.008	600
H-T1110	.01	600
H-T2450	.00005	1200
H-T2310	.0001	1200
H-T2320	.0002	1200
H-T2325	.00025	1200
H-T2330	.0003	1200
H-T2340	.0004	1200
H-T2350	.0005	1200
H-T2210	.001	1200
H-T2215	.0015	1200
H-T2220	.002	1200
H-T2225	.0025	1200
H-T2230	.003	1200
H-T5450	.00005	2500
H-T5310	.0001	2500
H-T5320	.0002	2500
H-T5325	.00025	2500
H-T5330	.0003	2500
H-T5340	.0004	2500
H-T5350	.0005	2500
H-T5210	.001	2500
H-T5215	.0015	2500

29/64" Max. Thickness		
H-K1115	.015	600
H-K1120	.02	600
H-K1125	.025	600
H-K1130	.03	600
H-K2240	.004	1200
H-K2250	.005	1200
H-K2260	.006	1200
H-K2280	.008	1200
H-K2110	.01	1200
H-K5220	.002	2500
H-K5230	.003	2500
H-K5240	.004	2500
H-K5250	.005	2500

NOTE: For meter mounting bracket add letter "E" to type designation.

NOTE: Standard tolerance $\pm 10\%$, B characteristic. Also available at extra cost in tolerances of $\pm 5\%$ and $\pm 2\%$.

NOTE: Test voltage is exactly double the working voltage listed.

TYPE 71 PAPER CAPACITORS

Catalog Number	Capacity mfd.	Dimensions—Inches					
		A	B	C	D	E	F
600 V.D.C. Working							
7106-.5	.5	1 13/16	1 1/16	1 5/8	7/8	13/16	2 1/4
7106-1	1.	1 13/16	1 1/16	2	7/8	13/16	2 1/4
7106-2	2.	1 13/16	1 1/16	2 3/4	7/8	13/16	2 1/4
7106-4	4.	2 1/2	1 3/16	2 7/8	7/8	1 1/8	3
7106-6	6.	2 1/2	1 3/16	3 3/4	7/8	1 1/8	3
7106-8	8.	3 3/4	1 1/4	3 1/4	7/8	2	4 3/8
7106-10	10.	3 3/4	1 1/4	3 7/8	7/8	2	4 3/8
1000 V.D.C. Working							
7110-1	.1	1 13/16	1 1/16	1 5/8	7/8	13/16	2 1/4
7110-.25	.25	1 13/16	1 1/16	1 5/8	7/8	13/16	2 1/4
7110-.5	.5	1 13/16	1 1/16	2	7/8	13/16	2 1/4
7100-1	1.	1 13/16	1 1/16	2 1/8	7/8	13/16	2 1/4
7110-2	2.	1 13/16	1 1/16	3 7/8	7/8	13/16	2 1/4
7110-4	4.	2 1/2	1 3/16	4 1/8	7/8	1 1/8	3
7110-6	6.	3 3/4	1 1/4	3 7/8	7/8	2	4 3/8
7110-8	8.	3 3/4	1 1/4	4 5/8	7/8	2	4 3/8
7110-10	10.	3 3/4	1 3/4	4 1/4	7/8	2	4 3/8
7110-12	12.	3 3/4	2 1/4	3 7/8	7/8	2	4 3/8
7110-15	15.	3 3/4	2 1/2	4 5/8	7/8	2	4 3/8
1500 V.D.C. Working							
7115-.5	.5	1 13/16	1 1/16	2 1/4	7/8	13/16	2 1/4
7115-1	1.	1 13/16	1 1/16	3 1/4	7/8	13/16	2 1/4
7115-2	2.	2 1/2	1 3/16	3 5/8	7/8	1 1/8	3
7115-4	4.	3 3/4	1 1/4	4 1/4	7/8	2	4 3/8
7115-6	6.	3 3/4	1 3/4	4 1/2	7/8	2	4 3/8
7115-8	8.	3 3/4	2 1/2	4 5/8	7/8	2	4 3/8
7115-10	10.	3 3/4	3 3/16	4 1/8	7/8	2	4 3/8
7115-12	12.	3 3/4	3 3/16	4 3/4	7/8	2	4 3/8
7115-15	15.	3 3/4	4 9/16	4 1/4	7/8	2	4 3/8
2000 V.D.C. Working							
7120-1	.1	1 13/16	1 1/16	1 5/8	1 3/8	13/16	2 1/4
7120-.25	.25	1 13/16	1 1/16	2	1 3/8	13/16	2 1/4
7120-.5	.5	1 13/16	1 1/16	2 7/8	1 3/8	13/16	2 1/4
7120-1	1.	2 1/2	1 3/16	3 1/4	1 3/8	1 1/8	3
7120-2	2.	3 3/4	1 1/4	3 3/4	1 3/8	2	4 3/8
7120-4	4.	3 3/4	2 1/4	3 3/4	1 3/4	2	4 3/8
7120-6	6.	3 3/4	2 1/2	4 3/4	1 3/4	2	4 3/8
7120-8	8.	3 3/4	3 3/16	4 3/4	1 3/4	2	4 3/8
7120-10	10.	3 3/4	4 9/16	4 3/4	1 3/4	2	4 3/8
7120-12	12.	3 3/4	4 9/16	5 1/8	1 3/4	2	4 3/8
2500 V.D.C. Working							
7125-.5	.5	2 1/2	1 3/16	2 7/8	1 3/4	1 1/8	3
7125-1	1.	3 3/4	1 1/4	3 1/4	1 3/4	2	4 3/8
7125-2	2.	3 3/4	1 3/4	4 3/4	1 3/4	2	4 3/8
7125-4	4.	3 3/4	2 1/4	5 1/8	1 3/4	2	4 3/8
7125-10	10.	3 3/4	4 9/16	6	1 3/4	2	4 3/8
3000 V.D.C. Working							
7130-1	.1	2 1/2	1 3/16	2	1 3/4	1 1/8	3
7130-.25	.25	2 1/2	1 3/16	2 1/2	1 3/4	1 1/8	3
7130-.5	.5	2 1/2	1 3/16	3 3/4	1 3/4	1 1/8	3
7130-1	1.	3 3/4	1 1/4	4 1/4	1 3/4	2	4 3/8
7130-2	2.	3 3/4	2 1/4	4 1/2	1 3/4	2	4 3/8
7130-4	4.	3 3/4	4 9/16	4 1/4	1 3/4	2	4 3/8
4000 V.D.C. Working							
7140-1	.1	3 3/4	1 3/4	3 1/4	1 3/4	2	4 3/8
7140-.25	.25	3 3/4	1 3/4	3 1/4	1 3/4	2	4 3/8
7140-.5	.5	3 3/4	1 3/4	3 1/2	1 3/4	2	4 3/8
7140-1	1.	3 3/4	2 1/4	4 1/4	1 3/4	2	4 3/8
7140-2	2.	3 3/4	3 3/16	5 1/2	1 3/4	2	4 3/8
7140-4	4.	3 3/4	4 9/16	7	1 3/4	2	4 3/8
5000 V.D.C. Working							
7150-.5	.5	3 3/4	2 1/4	4 1/4	2 3/4	2	4 3/8
7150-1	1.	3 3/4	4 9/16	4 1/4	2 3/4	2	4 3/8
7150-2	2.	3 3/4	4 9/16	5 3/4	2 3/4	2	4 3/8
6000 V.D.C. Working							
7160-1	1.	3 3/4	4 9/16	5	2 3/4	2	4 3/8

NOTE: Standard tolerance $\pm 10\%$.

NOTE: Brackets supplied at no extra cost.

NOTE: Items in normal demand carried in stock. Other items on special order only.

POWER RESISTORS — RHEOSTATS

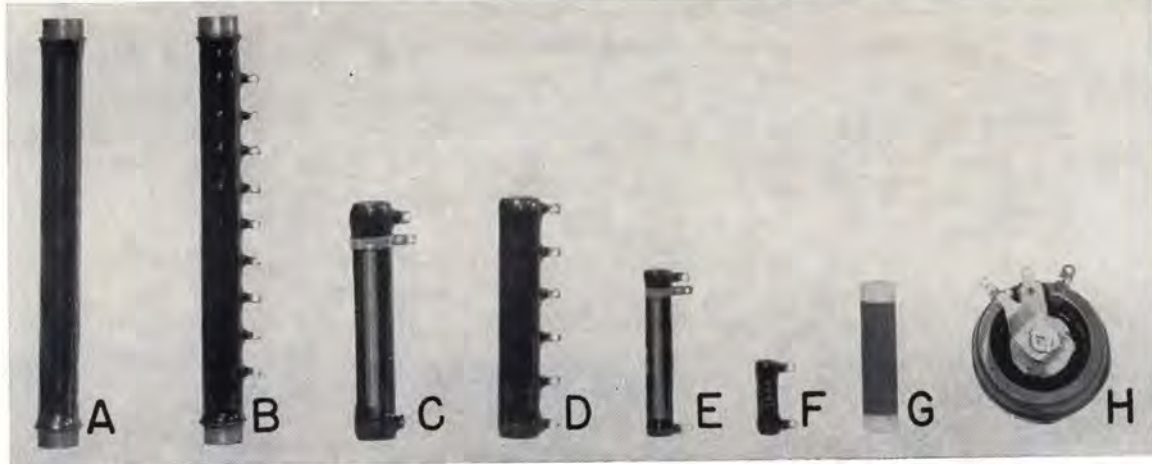

Ferrule resistors are highly desirable in radio transmitter construction. They may be changed quickly, are removable for cleaning both the resistor itself and under the resistor—and most important, have superior termination of the resistance tie point to the subsequent circuit. They are available in both fixed and tapped design. As ferrule resistors are manufactured to special order, you will find, listed below, those types normally purchased and carried in stock. Other values are available with only slight delay.

45 Watt Ferrule (5 1/8" x 1 3/8")

Available in all resistance values up to 100,000 ohms. Stock sizes: 50, 750, 1000, 3500, 10,000, 20,000, 30,000 and 50,000 ohms. When ordering, state resistance and catalog number listed below. Style A in illustration.

45 watt ferrule resistor. **Cat. 5M20-13**
 Ferrule mounting clip for above (2 req.) **Cat. 3160-250**

100 Watt Ferrule (7 1/2" x 1 1/8")

Available in all resistance values up to 200,000 ohms. Stock sizes: 2500, 5000, 10,000, 20,000, 25,000, 30,000 and 50,000 ohms. When ordering, state resistance value and catalog number listed below. Style A in illustration.

100 watt ferrule resistor. **Cat. 7K20-18**
 Ferrule mounting clip for above (2 req.) **Cat. 3160-600**

160 Watt Ferrule (9 5/8" x 1 1/8")

Available in all resistance values up to 200,000 ohms. Stock sizes: 1000, 1500, 2000, 2500, 5000, 8000, 10,000, 16,000, 20,000, 25,000, 30,000, 50,000 and 100,000 ohms. When ordering, state resistance value and catalog number listed below. Style A in illustration.

160 watt ferrule resistor. **Cat. 9K20-18**
 Ferrule mounting clip for above (2 req.) **Cat. 3160-600**

190 Watt Ferrule (11 1/2" x 1 1/8")

Available in all resistance values up to 200,000 ohms. Stock sizes: 100, 200, 412, 500, 1000, 1500, 2000, 2500, 4000, 5000, 10,000, 16,000, 100,000 ohms. When ordering, state resistance value and catalog number listed below. Style A in illustration.

190 watt ferrule resistor. **Cat. 11K20-18**
 Ferrule mounting clip for above (2 req.) **Cat. 3160-600**

Tapped Ferrule Resistors

Tapped resistors are generally considered superior to slider types, due to the positive, non-corroding contact. These are available in 110, 160 and 190 watt sizes, and with any reasonable number of taps. Following sizes are carried in stock: 500 ohms 160 watts with taps each 100 ohms, 10,000 ohms 160 watts with 10 equal taps, 10,000 ohms 190 watts with ten equal taps, 25,000 ohms 190 watts with 10 equal taps. Style B in above illustration.

Ferrule Carbon Resistors

These resistors are excellent as grid resistors in power stages, such as a class B modulator or R. F. amplifier, for the suppression of parasitic oscillations. Three types are carried: 100 ohms 4"x1" rated at 8 watts, 5000 ohms 12"x1" rated at 34 watts, and 10,000 ohms 12"x1" rated at 34 watts. When ordering, use type GLO with resistance value desired.

Standard Lug and Pig Tail Resistors

Standard wire wound resistors are available as follows:

10 watt (Style F). All sizes from 1 to 50,000 ohms. Order by value and	Cat. 1 1/4E	20 watt (Style F). All sizes from 5 to 100,000 ohms. Order by value and	Cat. 2R
50 watt (Style F). All sizes from 5 to 100,000 ohms. Order by value and	Cat. 4 1/2M	100 watt (Style F). All sizes from 5 to 100,000 ohms. Order by value and	Cat. 6 1/2K
160 watt (Style F). All sizes from 5 to 100,000 ohms. Order by value and	Cat. 8 1/2K	200 watt (Style F). All sizes from 5 to 100,000 ohms. Order by value and	Cat. 10 1/2K

Slider Type Resistors (Style C and E)

Slider or adjustable wirewound resistors are available in 50 watt, 100 watt and 200 watt sizes: They are available in values of 50, 100, 500, 1000, 2000, 3000, 4000, 5000, 7500, 10,000, 15,000, 20,000 and 25,000 ohms. It is suggested that slider type resistors be ordered in lowest possible resistance value, even if it is necessary to series with a fixed resistor, as finer wire sizes break easily.

For 50 watts order. **Cat. 4 1/2MV**
 For 100 watts order. **Cat. 6 1/2KV**
 For 200 watts order. **Cat. 10 1/2KV**

OHMITE RHEOSTATS

(Fig. H)

MODEL "H" 25 Watt

Diameter 1 9/16".		Depth behind panel 1 3/8".	
Stock No.	Ohms	Stock No.	Ohms
0140	1	0152	125
0141	2	0153	175
0142	3	0154	250
0143	6	0155	350
0144	8	0156	500
0145	10	0157	750
0146	15	0158	1,000
0147	25	0159	1,500
0148	35	0160	2,500
0149	50	0161	3,500
0150	75	0162	5,000
0151	100		

MODEL "J" 50 Watt

Diameter 2 5/16".		Depth behind panel 1 3/8".	
Stock No.	Ohms	Stock No.	Ohms
0308	0.5	0321	150
0309	1	0322	225
0310	2	0323	300
0311	4	0324	500
0312	6	0325	800
0313	8	0326	1,000
0314	12	0327	1,600
0315	16	0328	2,500
0316	22	0329	3,500
0317	35	0330	5,000
0318	50	0331	8,000
0319	80	0332	10,000
0320	125		

MODEL "K" 100 Watt

Diameter 3 3/8".		Depth behind panel 1 3/4".	
Stock No.	Ohms	Stock No.	Ohms
0440	0.5	0452	200
0441	1	0453	300
0442	2	0454	400
0443	3	0455	500
0444	5	0456	750
0445	7.5	0457	1,000
0446	10	0458	1,500
0447	16	0459	2,000
0448	25	0460	2,500
0449	50	0461	5,000
0450	75	0462	7,500
0451	100	0463	10,000

MODEL "L" 150 Watt

Diameter 4".		Depth behind panel 2".	
Stock No.	Ohms	Stock No.	Ohms
0524	0.5	0537	150
0525	1	0538	200
0526	2	0539	250
0527	3	0540	350
0528	5	0541	500
0529	7.5	0542	750
0530	10	0543	1,250
0531	15	0544	1,800
0532	25	0545	2,250
0533	35	0546	3,000
0534	50	0547	4,500
0535	75	0548	7,500
0536	100	0549	10,000

MODEL "N" 300 Watt

Diameter 6".		Depth behind panel 2 3/8".	
Stock No.	Ohms	Stock No.	Ohms
0650	1	0661	100
0651	2	0662	150
0652	3	0663	200
0653	4	0664	300
0654	5	0665	400
0655	7.5	0666	700
0656	10	0667	900
0657	15	0668	1,200
0658	25	0669	1,500
0659	50	0670	1,750
0660	75	0671	2,500

FM ANTENNAS, PICKUP ARMS, DUMMY ANTENNAS, AMPLIFIERS



Multi-V Antennas

One of the more popular FM antennas, because of its proven performance at low VSWR and very modest cost. Available in 2, 4 and 8 bays. Mounts on side of tower or supporting structure, as shown in illustration. Light in weight. Power rating up to 10 kw.

Power gain: 2-bay is 1.7, 4-bay 3.7, 8-bay 7.3. Two-bay weighs about 100 lbs., four-bay 175 lbs., and 8-bay 365 lbs. Separation between bays: about 10 feet. Pattern: circular within 1½ db. Polarization is horizontal. For use with 1½" coaxial cable; or smaller size with reducer. Manufactured by Andrew. For 88-108 mc only.

- FM antenna, 2-bay. Cat. 1302
- FM antenna, 4-bay. Cat. 1304
- FM antenna, 8-bay. Cat. 1308

Broad Band Antenna



Educational FM stations require an antenna that can be mounted atop a pole, is easy to tune up, and highly effective. Power gain: 0.8 between 88-108 mc. May be used with up to 3 kw of power. RG8U, RG11U, or RG17U coaxial cable is ideal. See page 216. Weighs about 35 lbs.

Broad Band Antenna
(state frequency).
Cat. FM-11



Pickup Arm A-16

This popular Livingston Arm may be used with all sizes of transcriptions and records, although the Universal listed above is suggested for LP. Accommodates any cartridge. See page 161. Vernier adjustment on stylus pressure. Adjustable height.

Pickup arm. Cat. A-16



Universal Pickup Arm

Made by Livingston, and an unusually fine arm at modest cost. For up to 16" records. Adjustable counterweight for LP. May be used with all GE reluctance cartridges, including triple-play. See page 161.

Universal pickup arm. Cat. LI-UNV-16
Same as above, but for 12" records. Cat. LI-UNV-12



Binaural Pickup Arm

Now that binaural recordings are available, many will be interested in this new dual-head arm. Used with conventional cartridges (see page 161). Independent action of each head. May be used with conventional recordings, also. For 12" records.

Binaural pickup arm. Cat. LI-BIN

FM TRANSMITTERS FOR COLLEGES — PAGE 37 • MORE PICKUPS AND ARMS — PAGE 161



5 kw Dummy Antenna

A complete, air-cooled unit that will handle 5 kw 100% modulated, or 10 kw without modulation. Consists of flat resistance wire ribbon, wound on micalex strips and generously spaced for heat dissipation. Change in resistance under modulation is negligible. Size: 27½" x 26½" x 10" high. Will mount on wall or sit flat on transmitter top.

- 5 kw Antenna, 51 ohms. Cat. DU-551
- 5 kw Antenna, 70 ohms. Cat. DU-570



1 kw Dummy Antenna

For use with any power up to 1 kw. Consists of non-inductive resistors, of special design, mounted on heavy steel plate. Cover not supplied. Rating of 1 kw is under 100% modulation. Change in resistance under modulation is negligible.

- 1 kw Antenna, 51 ohms. Cat. DU-151
- 1 kw Antenna, 70 ohms. Cat. DU-170
- 1 kw Antenna, 250 ohms. Cat. DU-1250

McIntosh Power Supply



Designed to operate Equalizer-Preamplifier, listed above, where Equalizer-Preamplifier is more than 30 feet from main amplifier. Delivers 40 ma DC at ripple less than 800 microvolts.

Power supply with tube. Cat. D-101



McIntosh 50-Watt Amplifier

A truly marvelous amplifier, producing a full 50 watts continuous power at less than 1% distortion. Gain: 40 db. Response: within 0.1 db from 20-20,000 cycles, and within 3 db from 10-100,000 cycles. Noise: 90 db below full output. Input: 100,000 ohms, or transformer (plug-in) available for 50, 250, or 600 ohms. Output: 4, 8, 16, 32 and 600 ohms. Tubes: 2 each, 6U4G, 6J5, 6L6G; and 1, 12AX7. Supplied with tubes and connecting cable.

50 Watt Amplifier. Cat. 50W-A2

Plug-in input transformer, for 50, 250, 600 ohms. Cat. M-107



McIntosh 30-Watt Amplifier

Superb quality is built into this 30-watt amplifier with self-contained power supply. Produces 30 watts, at less than ½% distortion 20-20,000 cycles. Response: within 0.1 db from 20-30,000 cycles; or, within 1 db up to 100,000 cycles. Input: 500,000 ohms. Output: 4, 8, 16 and 600 ohms.

30 Watt Amplifier. Cat. A-116



Equalizer—Preamplifier

When used with McIntosh amplifiers, provides bass accentuation, bass attenuation, treble accentuation, treble attenuation, and magnetic cartridge bass compensation with 3 positions. Distortion less than 0.3% from 20-20,000 cycles. Has master volume control. Supplied with connector to obtain power from amplifier and connect output to amplifier.

Equalizer-Preamplifier, less wood cabinet. Cat. C104

Same as above, with wood cabinet Cat. C104W

Gates Announco-mote

The only complete one piece remote equipment ready to attach to telephone line. For sports, news broadcasts, and many other uses. Low in price.

➔ See Page 177



ANTENNA TOWERS BY TOWER CONSTRUCTION COMPANY

Heavy Duty Television Tower

A massive tower, designed for 100 MPH wind and $\frac{1}{2}$ " ice load. Available in any height up to 600 feet. Will support all types of television transmitting antennas and their coaxial feed line or wave guide. Tower is double-braced throughout. Has heavy, round, solid steel legs; solid, round, diagonal braces; and angle horizontal bracing. Generously guyed for maximum protection. Tower is 100% hot dipped galvanized. May be purchased with or without erection service. Erection of TV radiator and transmission line may also be included in tower erection, if desired. **Please refer to 600 series towers.**

Medium Height AM Towers (to 240')

Available with or without base insulator for either shunt or series feed. A three-legged, guyed tower designed to stand 30 lbs. per square foot (approximately 100 miles per hour) wind load. Leg: 60 degree, "U" shape, rolled from hot billets. Complete "double lacing" with diagonal bracing. Type 1035 heat treated bolts are used exclusively. Uniform cross section design for entire height. Available in heights up to 240 feet. Either hot dipped galvanized or non-galvanized. Complete erection service also available where desired. Please refer to **type 12G series** for galvanized towers, or **type 12N** for non-galvanized.

Medium Height AM Towers (to 340')

Same general design as the type 12 series above, but with heavier member construction to allow heights up to 340 feet. May be purchased insulated or non-insulated at the base. Also galvanized or non-galvanized. Erection service optional. Please specify **tower series 15G** for galvanized, and **tower series 15N** for non-galvanized.

Maximum Height AM Towers

These towers are 38" wide, and available up to 510 feet in height. Otherwise same description as series 12 or series 15, above. Because of heavy construction, these towers may be used in medium heights (around 350 feet or less) to support modest TV or FM antennas. Available galvanized or non-galvanized, with or without base insulator. Erection service is optional. Please refer to **series 35G** for galvanized, and **series 35N** for non-galvanized.

Erection Service — Gates can quote complete or partial erection service; plowing in ground radials; installing TV or other antenna atop the towers; installing transmission line; painting and attachment of lights. We will gladly quote on request.

FOR TOWER LIGHTING EQUIPMENT SEE PAGES 209-212.
FOR TOWER CHOKES SEE PAGE 56.

WINCHARGER TOWER

Galvanized

Specifications

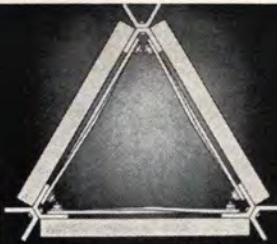

CROSS-SECTION

TOWER TYPE	RECOMMENDED MAX. HEIGHT	TOWER WIDTH	GUY LEVELS (DAYS # AND INCH)	WEIGHT PER FT. #	POWER # (KW/STANDARD)	TYPE OF BASE INSULATION
300	440 ft.	28 3/4 in.	50 ft.	30 lbs.	50,000	Locke or Lapp
230	350 ft.	23 3/4 in.	45 ft.	23 lbs.	10,000	Locke or Lapp
160	320 ft.	18 3/4 in.	40 ft.	15 lbs.	10,000	Locke or Lapp
101	220 ft.	14 3/4 in.	35 ft.	10.1 lbs.	5,000	Locke, Lapp or Ball & Socket
78	150 ft.	14 3/4 in.	35 ft.	7.8 lbs.	5,000	Locke, Lapp or Ball & Socket
42-47	125 ft.	13 3/4 in.	30 ft.	4.7 lbs.	3,000	Ball & Socket

*Tower steel only—weight of guys, insulators, etc. not included.
 †Insulation for greater power available at slight extra cost.

All towers are designed and stress tested to withstand 100 mile winds. Extra strong high carbon steel is used throughout. Tower legs are of the patented strong "U" shape. All legs, angles, braces, etc. are hot dipped galvanized after holes are punched. All nuts, bolts and lock washers are electro-galvanized. This produces high conductivity and provides the best non-corrosive finish available, insuring greater stability in broadcast patterns. Closely held tolerances on all parts insure exact fits and easy assembly of the tower. Double galvanized guy wires are insulated by high quality porcelain insulators at carefully pre-determined lengths.

On all towers the braces act as steps so any side can be easily climbed.

ALL LEGS, BRACES, ETC. ARE HOT-DIPPED GALVANIZED AFTER HOLES ARE PUNCHED

NOTE—Non-Galvanized Towers can be supplied at lower prices

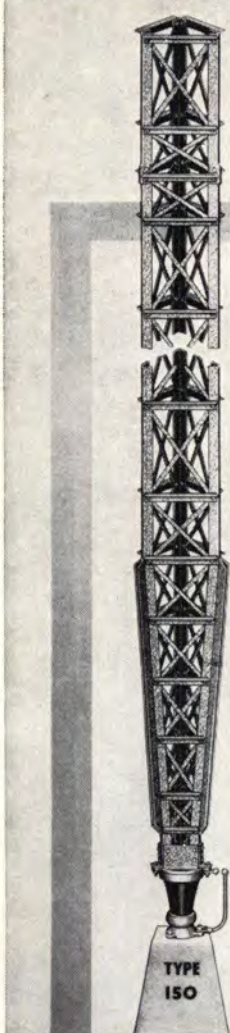

TYPE 150



TYPE 78



TYPE 300



TYPE 42-47



TYPE 101



TYPE 230



BALL & SOCKET BASE INSULATOR

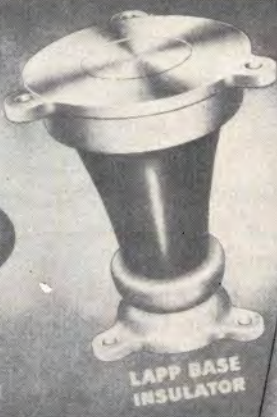

LAPP BASE INSULATOR

WINCHARGER TOWER SPECIFICATIONS

AIRLINE GOVERNMENT AND POLICE INSTALLATIONS

STANDARD BROADCAST INSTALLATIONS

A WINCHARGER TOWER FOR *Every* NEED!

All Wincharger Towers are available with or without erection service, as desired. Type 300 will support many types of TV radiators and associated transmission line. All towers are available with or without base insulators. Type 230, listed above, has been temporarily withdrawn. All other types are available. Please use tower styles listed above for catalog reference to price list.

FOR TOWER LIGHTS, SEE PAGES 209-212.
 FOR TOWER LIGHTING CHOKES, SEE PAGE 56.

TOWER LIGHT SELECTION GUIDE



The latest in Tower Lighting Kits designed to meet FCC Specifications, effective March 30, 1953.

TOWER LIGHTING KITS
SAVE TIME & MONEY
ENGINEERING TIME
PURCHASING TIME
ERECTION TIME

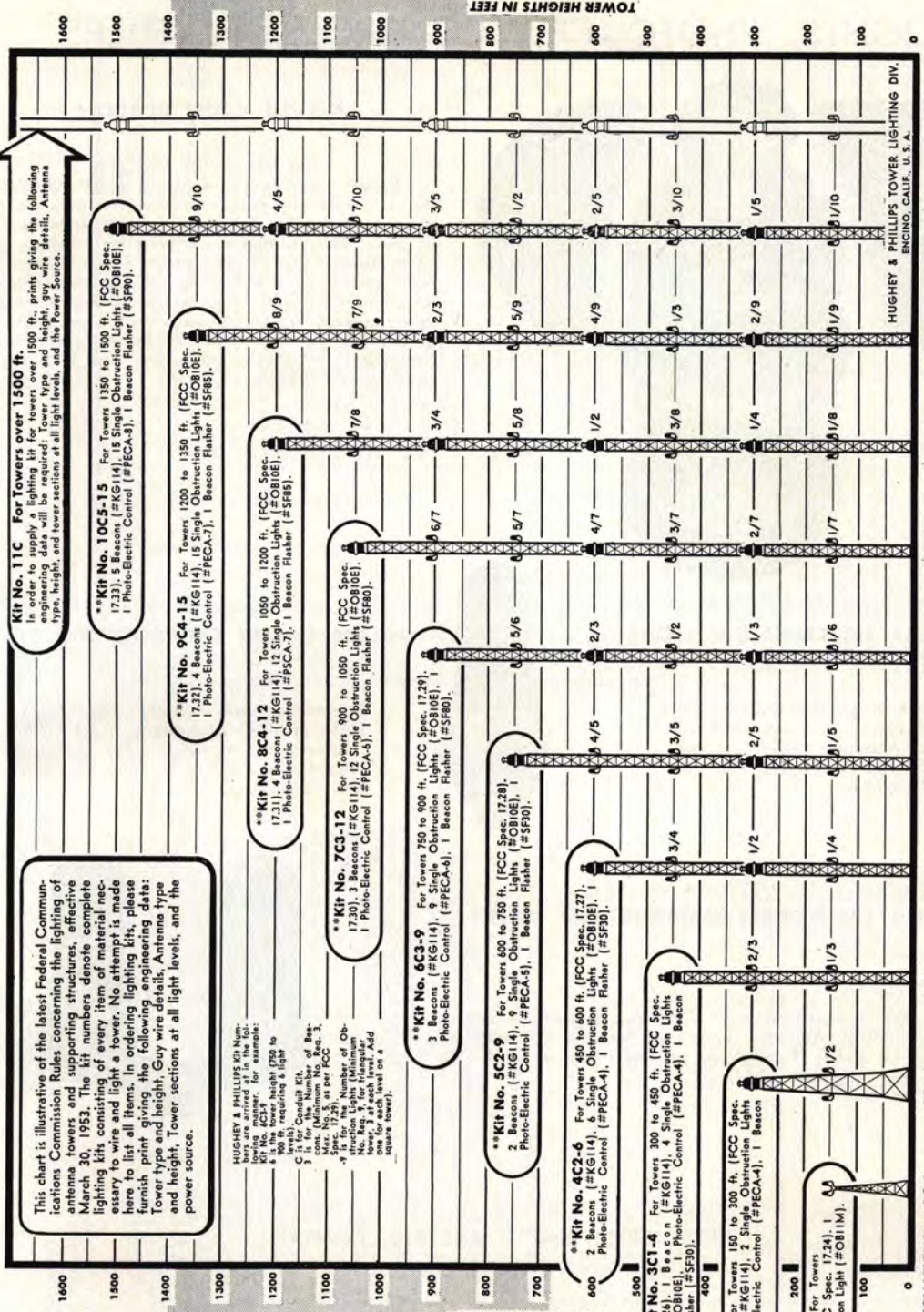

HUGHY & PHILLIPS KIT DESIGNATIONS → 1C-2 2C1-2 3C1-4 4C2-6 5C2-9 6C3-9 7C3-12 8C4-12 9C4-15 10C5-15 11C

HUGHY & PHILLIPS TOWER LIGHTING DIV. ENCINO, CALIF., U.S.A.

*All Kit Numbers listed are Galvanized Conduit Kit. All Exposed Wire Kits must be mounted on the outside of diagonally opposite corners at this level. For towers over 450 ft. require Obstruction Lights for each required level, unless otherwise specified.

**As per FCC Specifications: Towers over 450 ft. require a Beacon, within the tower, at levels other than the top. The number of levels requiring a Beacon depend on the tower height. If the visibility of a Beacon, at any level, is obstructed from any angle, by the Tower Structure, then two Beacons must be mounted on the outside of diagonally opposite corners at this level. Four will be supplied for square towers.

In order to supply lighting kits for towers topped by an antenna, which require lighting, engineering prints showing the type and overall dimensions of the antenna will also be required.

Reference Guide to FCC Approved Tower Lighting

The above guide, prepared jointly by Hughey and Phillips and the Gates Radio Company, is, we believe, the first of its kind. By referring to it you can, at once, pick the tower kit you need. Gates carries all necessary materials to make up any tower lighting kit and recommends Hughey and Phillips as the very finest.

TOWER LIGHTS, NEXT 3 PAGES

TOWER LIGHTS, PHOTO CELL CONTROLS, FLASHERS



KG114 CODE BEACON

300 MM CODE BEACON

Exclusive rain-proof ventilator dome "circulates" the air, materially reduces internal temperature and prolongs lamp life. Concave base with drainage port at lowest point dissipates condensation moisture; prevents short-circuits. Color screen supports insulated with spun glass shielding for glass-to-glass contact, equalizes reaction to temperature changes, eliminates color screen breakage. All parts readily accessible for adjustment or replacement. Neoprene gaskets used throughout for positive protection against dirt and moisture. CAA approved.



OB10E SINGLE OBSTRUCTION LIGHT

Side entrance Single Obstruction Light, precision designed to meet CAA requirements. Aluminum alloy castings, ruggedly constructed for long life, with red prismatic globes.



OB10M SINGLE OBSTRUCTION LIGHT

Bottom entrance Single Obstruction Light, precision designed to meet CAA requirements. Aluminum alloy castings, ruggedly constructed for long life, with red prismatic globes.

OB11M DOUBLE OBSTRUCTION LIGHT

Precision designed to meet CAA requirements. Aluminum alloy castings, ruggedly constructed for long life, with red prismatic globes. For lighting antenna structures up to 150 ft. as per FCC Spec. 17.24.



PECA SERIES PHOTO-ELECTRIC CONTROL



Factory-set to turn lights on at 35 f.c.; off at 58 f.c. as specified by CAA/FCC. Low-loss circuit insulation. High-wattage industrial type resistors. Tube ratings well over operational requirements. Fail-Safe: if any parts fail in service, lights automatically turn on. Models for all load capacities.

SF30E MERCURY BEACON FLASHER

Models available for any loads. Compact, spray-tight and drip-proof cast aluminum housing mountable on vertical OR horizontal member. Heavy-duty, self-starting, constant-speed synchronous timing motor is unaffected by extreme temperature and voltage ambients. Positive-acting ELECTRONIC fail-safe circuit guards against failure of ANY component.



Kit No. A3-GCK

WIRING DIAGRAM & MATERIAL LIST

CAA TYPE A3 TOWER LIGHTING

Uniform Cross-Sectional Tower (See Note 1)

For Tower Heights 150 to 400 ft.

(Galvanized Conduit Kit)

TYPICAL HUGHEY & PHILLIPS LIGHTING KIT

IMPORTANT

Install All Wires with Drip-Loops As Shown

Item No.	Part No.	Quantity	Description
1	KG114	1	300 MM Code Beacon w/ 2 Red Color Screens.
2	SF30E	4	Cable-Neoprene, Type SO, #2 Conductor.
3	OB10EZ	4	Mercury Code Flasher, Weatherproof Housing & Mounting Bracket.
4		1	Single Obstruction Light, Multiple Med. Screw w/ Red Fresnel Globe.
5		6	620W., 120 V., Med. Screw Airway Beacon Lamps (2 Spares).
6		4	111W., 120 V., Med. Screw Traffic Signal Lamps (4 Spares).
7	L2222-3	3	Junction Box, Weatherproof $\frac{3}{4}$ " Hubs, w/ Terminal Block.
8	L3333-3	3	Nipple-Conduit, Galv. $\frac{3}{4}$ " x 12".
9		2	Nipple-Conduit, Galv. $\frac{3}{4}$ " x 18".
10		2	Nipple-Conduit, Galv. $\frac{3}{4}$ " x 24".
11		2	Couplings-Conduit, Galv. $\frac{3}{4}$ " (Spares).
12		2	Conduit Fitting, Offset 1".
13		1	Conduit Fitting, Cover, 1".
14		1	Conduit Fitting, Gasket, 1".
15		2	Union-Conduit, Male 1".
16		2	Reducer-Conduit, 1" x $\frac{3}{4}$ ".
17		2	Pipe Plugs, Recessed Head, $\frac{3}{4}$ ".
18		2	Locknuts-Conduit, $\frac{3}{4}$ ".
19		1	Connector-Weathertight, $\frac{3}{4}$ " for (** O.D.) Cable.
20		1	Kit-Wraplock Tape, Stainless Steel, $\frac{1}{2}$ " x 100".
21		1	Bolts-Galv. w/ Nuts and Lockwashers, $\frac{1}{2}$ " x 2".
22		4	Wire-Moistureproof, #14 TW (White).
23		5	Wire-Moistureproof, #10 TW (White).
24		5	Wire-Moistureproof, #10 TW (Black).
25		5	Wire-Moistureproof, #10 TW (Red).
26		5	Wire-Moistureproof, #8 TW (White).
27		5	Wire-Moistureproof, #8 TW (Black).
28		5	Wire-Moistureproof, #8 TW (Red).
29		5	Wire-Moistureproof, #8 TW (White).
30		5	Wire-Moistureproof, #8 TW (Black).
31		5	Wire-Moistureproof, #8 TW (Red).
32		5	Wire-Moistureproof, #8 TW (White).
33		5	Wire-Moistureproof, #8 TW (Black).
34		5	Wire-Moistureproof, #8 TW (Red).

† Detail prints and parts list covering items 1, 3 and 4 are available upon request from your distributor, or contact your nearest HUGHEY & PHILLIPS Office.
 * Standard Kits have 4 ft. of No. 12 Gauge attached, on special installations see specific Bill of Materials.
 ** Standard Kits have rubber gromet for Item 2 Cable O.D., on special installations see specific Bill of Materials.
 *** Height of Tower plus 15 ft. of each color. May be furnished in lengths equivalent to or in multiples of 1/3 height of tower, with colors equal in length.
 **** Height of tower in 10 ft. lengths.
 Item 1. 300 MM Code Beacon, is shipped completely assembled including Item 2, except for the two red color screens which are packed separately and should be installed only after the beacon has been permanently bolted to the tower with item No. 25.
 Item 15. Mercury Flasher Unit, is provided with "U" bolts in the event tower leg is not wide enough to be drilled for bracket mounting holes. Be sure that unit is earth level in both directions for proper operation of Mercury Tube. Bracket can be adjusted for tower slope in one direction only.
 NOTE: 1. This material list allows for towers, triangular or square, where the face dimension does not exceed 3 ft. at the 1/3, 2/3, or top levels. This includes self-supporting types falling within these limits. For exceptions to this, furnish tower prints or dimensions and see specific Bill of Materials.

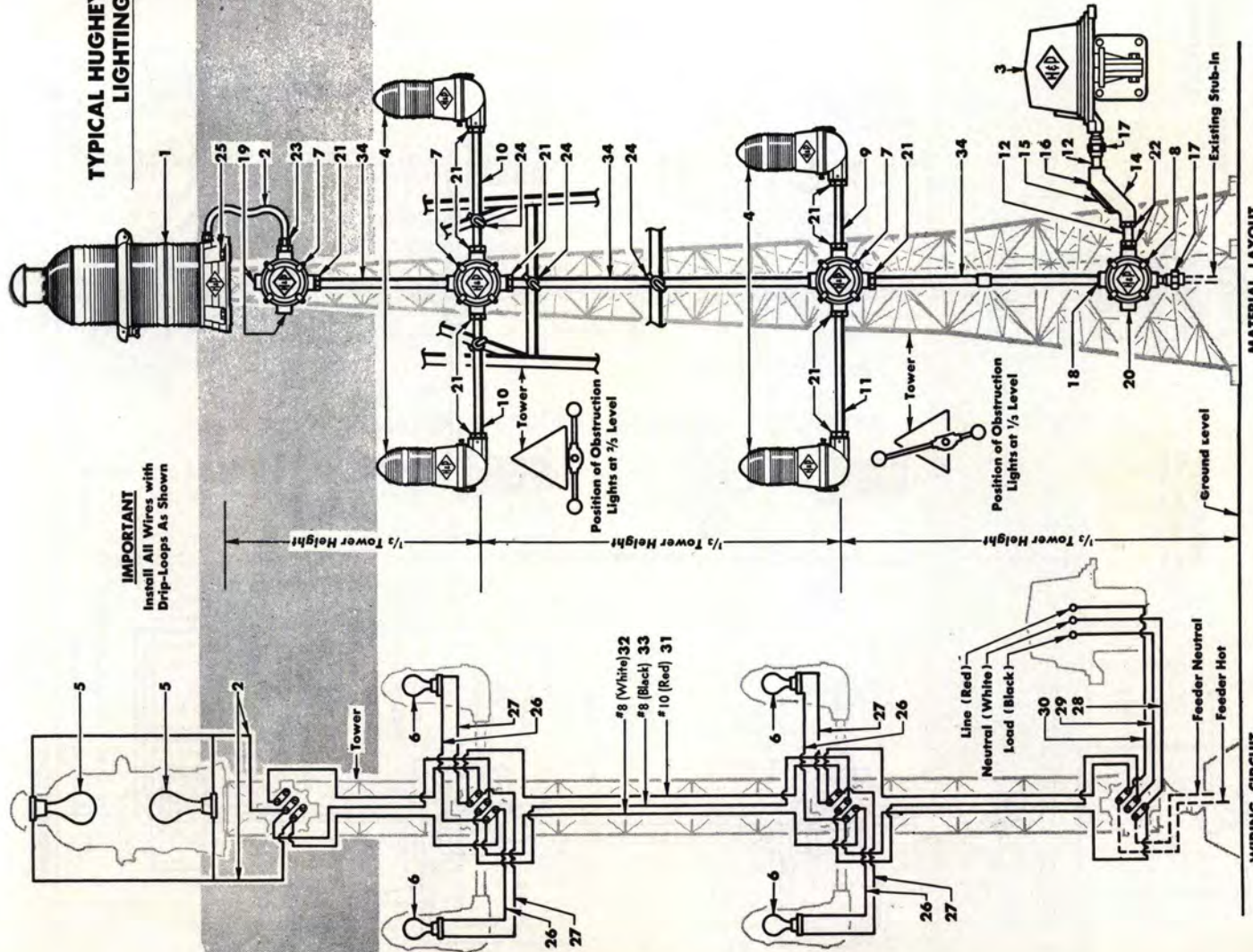

INSTALLATION DRAWING FOR A3-GCK

DO YOU NEED NEW BULBS FOR YOUR PRESENT TOWER LIGHTS?
 —THE GATES CONSOLIDATED PRICE LIST SHOWS THEM ALL... STOCK DELIVERY.

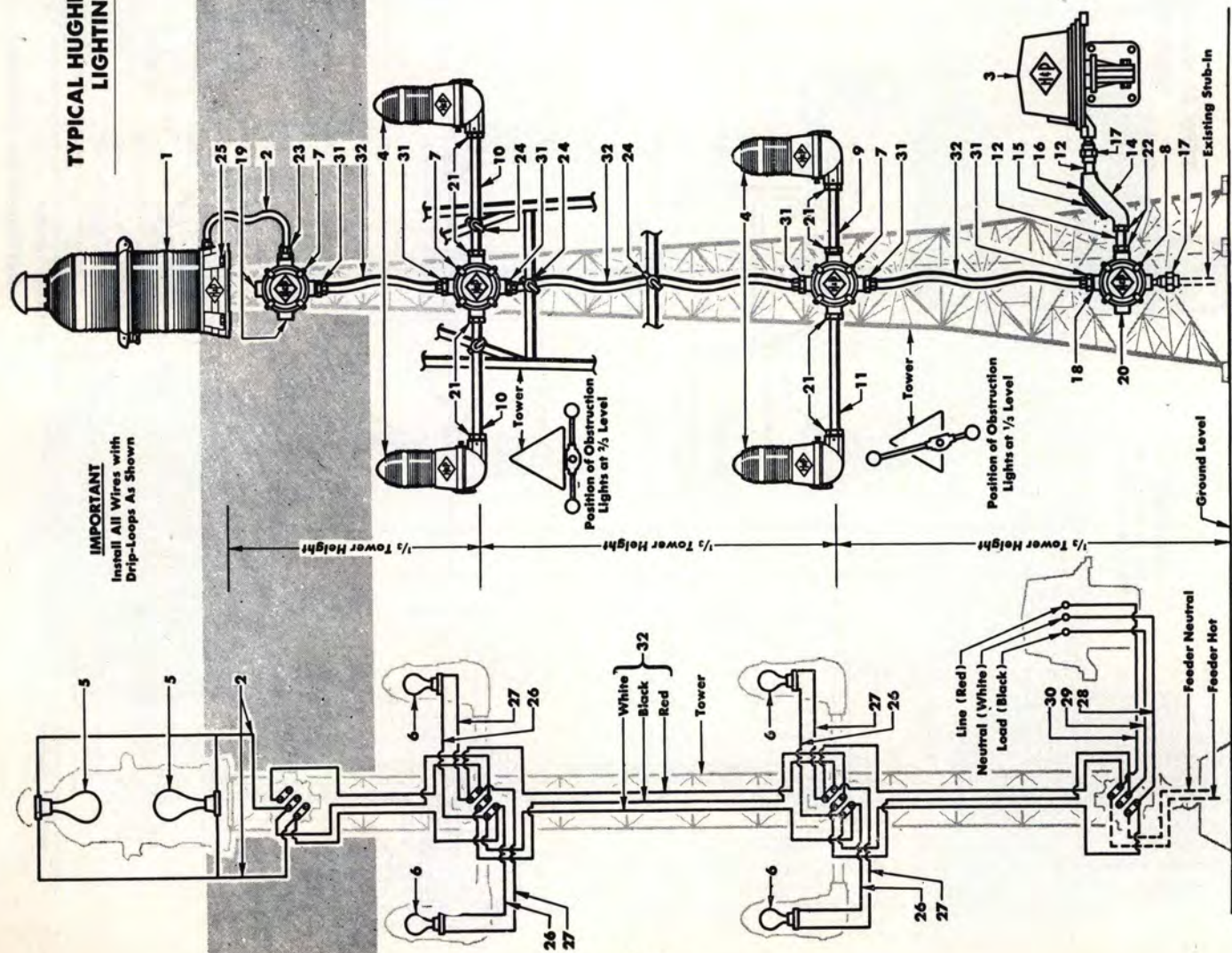

IMPORTANT
Install All Wires with Drip-Loops As Shown

TYPICAL HUGHEY & PHILLIPS LIGHTING KIT
CAA TYPE A3 TOWER LIGHTING
Uniform Cross-Sectional Tower (See Note 1)
For Tower Heights 150 to 400 ft.
(Exposed Wire Kit)

Kit No. A3-EWK

WIRING DIAGRAM & MATERIAL LIST

Item No.	Part No.	Quantity	Description
1	KG114	1	300 MM Code Beacon W/2 Red Color Screens.
2	SF30E	1	Cable-Neoprene, Type SO, #2 Conductor.
3	OB10E2	4	Mercury Code Flasher, Weatherproof Housing & Mounting Bracket.
4		4	Single Obstruction Light, Multiple Med. Screw w/Red Fresnel Globe.
5		8	620W., 120 V., Med. Screw Traffic Signal Lamps (2 Spares).
6		3	111W., 120 V., Med. Screw Traffic Signal Lamps (4 Spares).
7	L2222-3	3	Junction Box, Weatherproof 3/4" Hubs, w/Terminal Block.
8	L3333-3	2	Nipple-Conduit, Galv., 3/4" x 12".
9		2	Nipple-Conduit, Galv., 3/4" x 18".
10		2	Nipple-Conduit, Galv., 3/4" x 24".
11		2	Couplings-Conduit, Galv., 3/4" (Spares).
12		2	Conduit Fitting, Offset 1".
13		2	Conduit Fitting, Cover, 1".
14		2	Conduit Fitting, Gasket, 1".
15		2	Union-Conduit, Male 1".
16		2	Reducer-Conduit, 1" x 3/4".
17		2	Pipe Plugs, Recessed Head, 3/4".
18		2	Locknuts-Conduit, 3/4".
19		2	Connector-Weathertight, 3/4" for (***O.D.) Cable.
20		12	Kit-Wraplock Tape, Stainless Steel, 1/2" x 100".
21		2	Bolts-Galv., w/Nuts and Lockwashers, 1/2" x 2".
22		4	Wire-Moistureproof, #14 TW (White).
23		20 ft.	Wire-Moistureproof, #14 TW (Red).
24		20 ft.	Wire-Moistureproof, #10 TW (White).
25		5 ft.	Wire-Moistureproof, #10 TW (Black).
26		5 ft.	Wire-Moistureproof, #10 TW (Red).
27		6	Connector-Weathertight, 3/4" for (***O.D.) Cable.
28		6	Cable-Weatherproof, 3 Conductor, Type (See Kit Bill of Material).
29		6	
30		6	
31		6	
32		6	

† Detail prints and parts list covering items 1, 3 and 4 are available upon request from your distributor, or contact your nearest HUGHEY & PHILLIPS Office.
* Standard Kits have 4 ft. of No. 12 Gauge attached, on special installations see specific Bill of Materials.
** Standard Kits have rubber gromet for Item 2 Cable O.D., on special installations see specific Bill of Materials.
*** Connectors will have rubber gromet to fit O.D. of Item 32 Cable. For size see specific Bill of Materials.
**** Height of tower plus 15 ft., color coded. May be furnished in lengths equivalent to or in multiples of 1/3 height of tower.
Item 1. 300 MM Code Beacon, is shipped completely assembled including Item 2, except for the two red color screens which are packed separately and should be installed only after the beacon has been permanently bolted to the tower with item No. 25.
Item 15. Mercury Flasher Unit is provided with "U" bolts in the event tower leg is not wide enough to be drilled for bracket mounting holes. Be sure that unit is earth level in both directions for proper operation of Mercury Tube. Bracket can be adjusted for tower slope in one direction only.
NOTE 1. This material list allows for towers, triangular or square, where the face dimension does not exceed 3 ft. at the 1/3, 2/3, or top levels. This includes self-supporting types falling within these limits. For exceptions to this, furnish tower prints or dimensions and see specific Bill of Materials.

ORDER TOWER LIGHTS FROM GATES.
DELIVERY DIRECT OUT OF QUINCY,
ILL., HOUSTON, TEXAS, ATLANTA, GA.,
OR LOS ANGELES STOCK.

COAXIAL CABLE

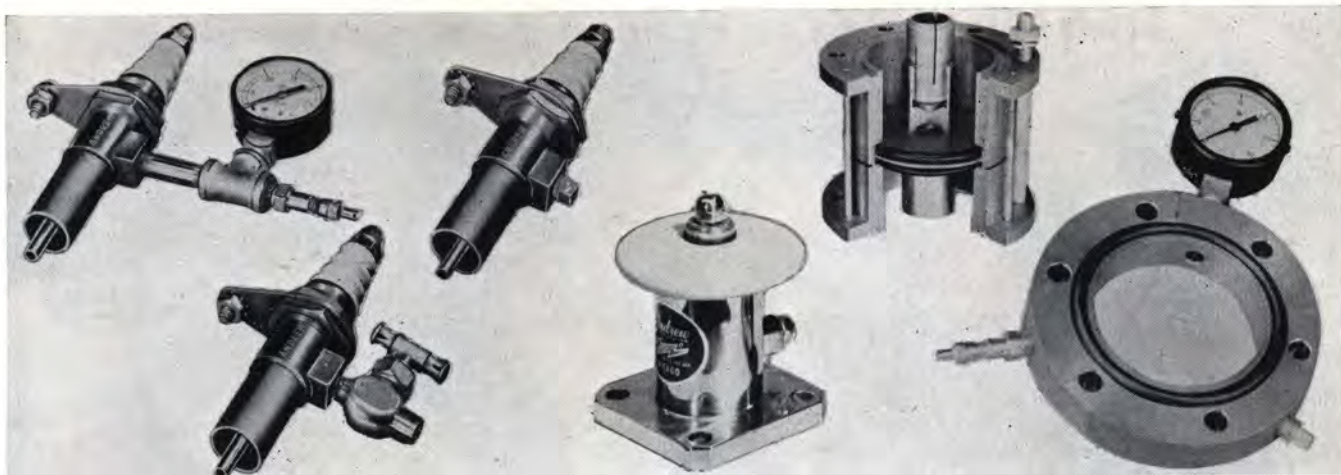

3/8" DIAMETER, TYPE 83 SEMI-FLEXIBLE (70 OHMS)

Description	Cat. No.	Description	Cat. No.
Coaxial cable 3/8" diameter semi-flexible.....	83	Right angle junction box for 3/8" cable. Use where bending radius sharper than 6 inches is required.....	853
Solder connectors, inner and outer, (pair).....	8319	T Junction Box for 3/8" cable.....	825
End terminal with removable exhaust plug, ceramic insulated.....	1701-P	Collar clamp (for passing cable thru panel).....	830
End terminal with pressure gauge and inlet valve, ceramic insulated.....	1701-GV	Coupling with side connection for 1/4" copper tubing.....	915
End terminal with gas release valve, ceramic insulated.....	1701-R	Coupling with gas release valve on side.....	915-R

7/8" DIAMETER, TYPE 737, SEMI-FLEXIBLE (64 OHMS)

Coaxial cable 7/8" diameter semi-flexible.....	737	Y junction box for 7/8" cable.....	859
Reducer connector, Type 737 to Type 83 cable.....	8329	Collar clamp (for passing cable thru panel).....	829
Adaptor, Type 737 to Type 451 flanged line.....	4876-1	Split collar clamp (two piece, for passing 7/8" cable thru panel).....	4878
Solder connectors, outer and inner, (pair).....	8328-B	Coupling with side connection for 1/4" copper tubing.....	917
Pair of connectors, solder outer, solderless inner.....	8328-C	Coupling with gas release valve on side.....	917-R
End terminal for 7/8" cable, ceramic insulated, with removable exhaust plug.....	1703-P	Coupling with pressure gauge and valve on side.....	917-GV
End terminal for 7/8" cable, ceramic insulated with pressure gauge and inlet valve.....	1703-GV	Adaptor for connecting Type 737 cable to RG-17/U solid dielectric cable. Fits on 1703 terminal and provides male thread to fit plug UG-154/U on end of solid dielectric cable. Terminal and plug not included.....	L-12423
End terminal for 7/8" cable, ceramic insulated, with gas release valve.....	1703-R	Pair of swivel flanges for field attachment to Type 737 cable. Includes solderless inner connector and all necessary hardware for joining flanges.....	L-13223-1
Right angle junction box for 7/8" cable. Use where bending radius sharper than 12" is desired.....	61	Single swivel flange for field attachment to Type 737 cable. Includes solderless inner connector and all necessary hardware.....	L-13223-2
Right angle bend, 7/8" cable bent to 12" radius, with 2 solder connectors.....	6500		
T junction box for 7/8" cable.....	65		

1 5/8" DIAMETER, TYPE 451 CERAMIC INSULATED (51.5 OHMS)

Transmission line, 1 5/8" diameter, 20 foot section.....	451	Tapered adaptor, Type 451 to RG-8/U solid dielectric cable. Flange on 1 5/8" end. Other end terminates in Type N fitting which requires UG-21/U plug (not included) on end of RG-8/U cable. Does not incorporate gas barrier.....	L-12859
Transmission line, similar to 451 except flange on one end only.....	451-1	Hardware kit for 451. Includes nuts and bolts for 6 flanged connections, 10 rubber gaskets, and 2 inner connectors.....	2451
Transmission line, similar to 451 except no end flanges.....	451-2	Special length of 451 transmission line with flanges on both ends. Indicate length in inches.....	M-12211
Right angle bend for Type 451.....	M-13941	Special length 1 5/8" transmission line, no end flanges. Specify length in inches. Price per inch.....	M-13280
Right angle bend, similar to Type M-13941 except flanged on one end only.....	M-13941-1	Five foot length of 451 transmission line, flanged on one end only.....	M-12843-5
Right angle bend, similar to Type M-13941 except no end flanges.....	M-13941-2	Ten foot length of 451 transmission line, flanged on one end only.....	M-12843-10
45 degree bend for Type 451.....	M-14216	Fifteen foot length of 451 transmission line, flanged on one end only.....	M-12843-15
45 degree bend, similar to Type M-14216 except flanged on one end only.....	M-14216-1	Extra clamp for 1 5/8" OD ungassed line.....	L-11809-2
45 degree bend, similar to Type M-14216 except no end flanges.....	M-14216-2	Set of hardware (nuts, bolts, lock-washers) for joining one pair of 1 5/8" flanges.....	L-11381-2
Special angle bend for Type 451. Indicate desired angle in degrees change of direction. Maximum angle, 90 degrees.....	K-13273	Flange for Type 451 transmission line.....	K-10875
Clamp connector for providing a flange on cut end of Type 451.....	T-1551	Silver solder ring preform, for brazing flange to line.....	K-10419-2
Gas barrier for Type 451.....	T-1251	Rotating and fixed ring for 1 5/8" swivel flange. Includes silver solder ring preform.....	K-14485
Reducer connector, Type 452 to 451.....	T-1851		
Ungassed reducer, 3 1/8" to 1 5/8", 51.5 ohms both sides.....	T-4831		
Ungassed straight coupling 1 5/8".....	T-4832		

COAXIAL CABLE

1 5/8" DIAMETER, TYPE 451 CERAMIC INSULATED (Continued)

Description	Cat. No.	Description	Cat. No.
Inner conductor tube 0.647" OD x 12 feet long	K-12233-2	Inner connector, used in joining adjacent sections of 1 5/8" transmission line. Not recommended for connection to fittings because of mechanical interference.	K-13944
Rubber gasket for 451 line	L-10683-2	Inner connector, used in connecting 1 5/8" line to fittings. Not recommended for joining sections of transmission line.	K-14156
Blank cover plate for capping 1 5/8" flange. With 1/8" pipe plug	K-12234-1	Clamp and grounding strap for connecting line to tower in quarter wave isolation systems.	K-12430
Clamp connector ungasged, for outer conductor only. Provides flange on cut end of Type 451.	T-4837		
Gas inlet coupling for 451 line	1351		

1 5/8" DIAMETER, TYPE 551-4 TEFLON INSULATED (51.5 OHMS)

Description	Cat. No.	Description	Cat. No.
Transmission line, 1 5/8" diameter, 20 foot section	551-4	Reducer connector, Type 552-1 to Type 551-4 line	M-12514
Special length Type 551-4 transmission line with flanges on both ends. Indicate length in inches	M-13981	Clamp connector for providing a flange on cut end of Type 551-4 line	1551

The following fittings, as described under Type 451, may also be used with Type 551-4 line.

Description	Cat. No.	Description	Cat. No.	Description	Cat. No.
90 degree bend	M-13941	Gas barrier	T-1251	Hardware kit	L-11381-2
90 degree bend	M-13941-1	Reducer	T-1851	Flange	K-10875
90 degree bend	M-13941-2	Rubber gasket	L-10683-2	Solder ring	K-10419-2
45 degree bend	M-14216	Blank flange	K-12234-1	Swivel flange	K-14485
45 degree bend	M-14216-1	Gas inlet	1351	Inner connector	K-13944
45 degree bend	M-14216-2	Reducer	L-12859	Inner connector	L-14156
Special bend	K-13273	Hardware kit	2451	Grounding strap	K-12430

3 1/8" DIAMETER, TYPE 452 CERAMIC INSULATED (51.5 OHMS)

Description	Cat. No.	Description	Cat. No.
Transmission line 3 1/8" diameter, 20 foot section	452	Ten foot length of 452 transmission line, flanged on one end only	M-12844-10
Transmission line, similar to 452, except flange on one end only	452-1	Fifteen foot length of 452 transmission line, flanged on one end only	M-12844-15
Transmission line, similar to 452, except no end flanges	452-2	Extra clamp for 3 1/8" OD ungasged line	L-11809-1
Right angle bend for 452	T-1052	Inner conductor tube 1.282 OD x 12 feet long	K-12233-3
Right angle bend similar to T-1052 except flange on one end only	T-1052-1	Rubber gasket for 452 line	L-10683-3
Right angle bend similar to T-1052 except no end flanges	T-1052-2	Blank cover plate for capping 3 1/8" flange. With 1/8" pipe plug	K-12234-2
45 degree bend for 452	T-1152	Gas inlet coupling for 452 line	1352
45 degree bend, similar to T-1152 except flange on one end only	T-1152-1	Hardware kit for Type 452. Includes nuts and bolts for 4 flanged connections, 10 rubber gaskets, and 2 inner connectors	2452
45 degree bend, similar to T-1152 except no end flanges	T-1152-2	Inner connector, used in joining adjacent sections of 3 1/8" transmission line. Not recommended for connection to fittings because of mechanical interference.	K-14417
Special angle bend for Type 452. Indicate desired angle in degrees change of direction. Maximum angle 90 degrees	T-1952	Inner connector, used in joining 3 1/8" line to fittings. Not recommended for joining sections of transmission line.	L-12650-2
Clamp connector, for providing a flange on cut end of 452	T-1552	Rotating and fixed ring for 3 1/8" swivel flange. Includes silver solder ring preform.	K-14486
Gas barrier	T-1252	Inner conductor adaptor, to adapt fittings designed for Type 452 line to fit Type 552-1 line or vice versa	K-13244-1
Reducer connector, Type 452 to 451	T-1851	Set of hardware (nuts, bolts, lock-washers) for joining one pair of 3 1/8" flanges	L-11381-3
Reducer connector, ungasged, 3 1/8" to 1 5/8"	T-4831	Flange for Type 452 transmission line	L-10881
Straight coupling 3 1/8" ungasged	T-4838	Silver ring preform for brazing 3 1/8" flange	K-10419-11
Special length of 3 1/8" OD 51.5 ohms transmission line flanged both ends. Specify length in inches	M-12173	Clamp and grounding strap for connecting line to tower in quarter wave isolation systems	K-12431
Special length of 3 1/8" transmission line, no end flanges. Specify length in inches. Price per inch	M-13278		
Five foot length of 452 transmission line, flanged on one end only	M-12844-5		

3 1/8" DIAMETER, TYPE 552-1 TEFLON INSULATED (51.5 OHMS)

Description	Cat. No.	Description	Cat. No.
Transmission line, 3 1/8" diameter, 20 foot section	552-1	Special length Type 552-1 transmission line with flanges on both ends. Indicate length in inches	M-13325
Right angle bend for Type 552-1 line	M-12512	Inner connector, used in connecting 3 1/8" line to fittings. Not recommended for joining sections of transmission line.	L-12650-3
45 degree bend for Type 552-1 line	M-12513	Inner connector, used in joining adjacent sections of 3 1/8" transmission line. Not recommended for connection to fittings because of mechanical interference.	K-13946
Special angle bend for Type 552-1. Indicate desired angle in degrees change of direction. Maximum angle 90 degrees	M-13928	Hardware kit for Type 552. Includes nuts and bolts for four flanged connections, ten rubber gaskets and two inner connectors	2552
Reducer connector, Type 552-1 to 551-1 or 451	M-12514		
Clamp connector, for providing a flange on cut end of 552-1	L-12515		
Gas barrier for 552-1	L-13163		
Reducing inner connector to adapt fittings designed for 452 line to fit Type 552-1 line	K-13244-1		

COAXIAL CABLE

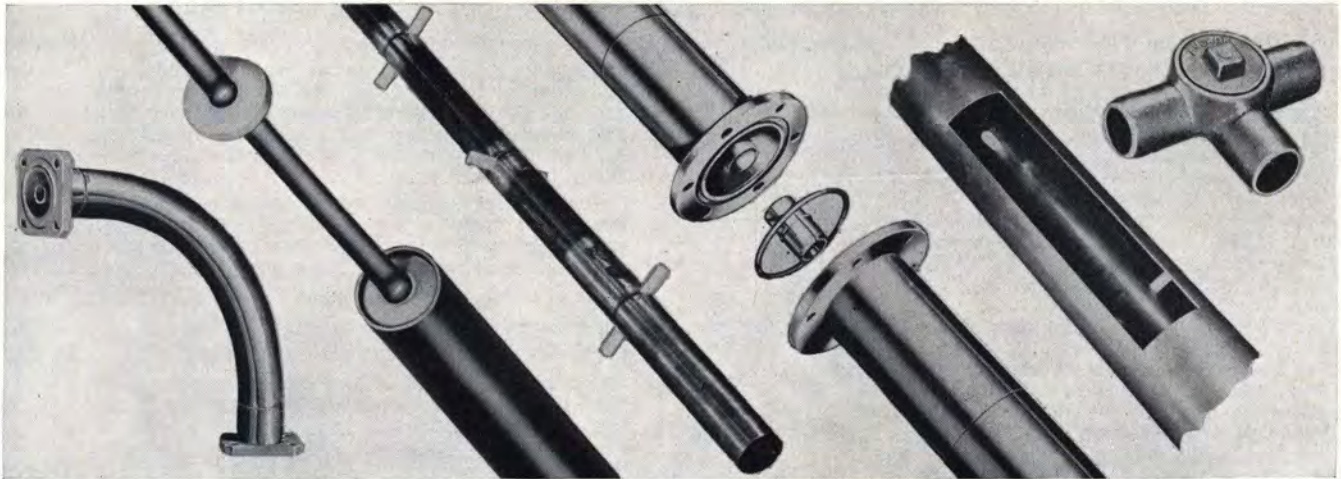

3 1/8" DIAMETER, TYPE 552-1 TEFLON INSULATED (51.5 Ohms) Continued

In addition, the following fittings, as described under Type 452 may be used with Type 552-1 line.

Description	Cat. No.	Description	Cat. No.	Description	Cat. No.
Rubber gasket.....	L-10683-3	Flange.....	L-10881	Swivel flange.....	K-14486
Blank flange.....	K-12234-2	Solder ring.....	K-10419-11	Inner adaptor.....	K-13244-1
Hardware kit.....	L-11381-3	Grounding strap.....	K-12431		

6 1/8" DIAMETER, TYPE T-453 TRANSMISSION LINE

Description	Cat. No.	Description	Cat. No.
Transmission line, 6 1/8" diameter, 20 foot section.....	T-453	Hardware kit for Type T-453. Includes nuts and bolts for 2 flanged connections, 10 rubber gaskets, and 2 inner connectors.....	2453
Right angle bend for Type T-453.....	T-1053	Set of hardware (nuts, bolts, lock-washers) for joining one pair of 6 1/8" flanges.....	L-11381-4
45 degree bend for Type T-453.....	T-1153	Flange for Type T-453 line.....	L-11271
Special angle bend for Type T-453. Indicate desired angle in degrees change of direction. Maximum angle 90 degrees.....	T-1953	Silver ring preform for brazing flange.....	K-10419-30
Gas barrier for Type T-453.....	T-1253	Rubber gasket for 6 1/8" flange.....	L-10683-10
Gas inlet coupling for Type T-453.....	1353	Inner connector for T-453 line.....	K-14418
Clamp connector, for providing a flange on cut end of Type T-453.....	1553	Rotating and fixed rings for 6 1/8" swivel flange. Includes silver solder ring preform.....	K-14675
Reducer connector, Type T-453 to 452.....	T-1852		

1 5/8" DIAMETER, TYPE 561 TEFLON INSULATED (50 OHMS)

(UHF Line)

UHF transmission line, 1 5/8" diameter, for UHF channels 14-45 inclusive, 20 foot section.....	561-5	Reducer connector, 3 1/8" Type 562 to 1 5/8" Type 561.....	1861
UHF transmission line, 1 5/8" diameter, for UHF channel 46-83 inclusive, 20 foot section.....	561-3	Special angle bend for Type 561. Indicate desired angle in degrees change of direction. Maximum angle, 90 degrees.....	1961
Right angle bend for Type 561.....	1061	Hardware kit for Type 561. Includes nuts and bolts for 6 flanged connections, 10 rubber gaskets and 2 inner connectors.....	2461
45 degree bend for Type 561.....	1161	Special length Type 561-3 transmission line with flanges on both ends. Indicate length in inches.....	2761
Gas barrier for Type 561.....	1261	Special length Type 561-5 transmission line with flanges on both ends. Indicate length in inches.....	2861
Gas inlet coupling for Type 561.....	1361		
Clamp connector, for providing flange on cut end of Type 561 line.....	1561		

3 1/8" DIAMETER, TYPE 562 TEFLON INSULATED (50 OHMS)

(UHF Line)

UHF transmission line, 3 1/8" diameter, for UHF channels 14-45 inclusive, 20 foot section.....	562-5	Reducer connector, 3 1/8" Type 562 to 1 5/8" Type 561.....	1861
UHF transmission line, 3 1/8" diameter, for UHF channels 46-83 inclusive, 20 foot section.....	562-3	Special angle bend for Type 562. Indicate desired angle in degrees change of direction. Maximum angle, 90 degrees.....	1962
Right angle bend for Type 562.....	1062	Hardware kit for Type 562. Includes nuts and bolts for 4 flanged connections, 10 rubber gaskets, and 2 inner connectors.....	2462
45 degree bend for Type 562.....	1162	Special length Type 562-3 transmission line with flanges on both ends. Indicate length in inches.....	2762
Gas barrier for Type 562.....	1262	Special length Type 562-5 transmission line with flanges on both ends. Indicate length in inches.....	2862
Gas inlet coupling for Type 562.....	1362		
Clamp connector, for providing flange on cut end of Type 562 line.....	1562		

COAXIAL CABLE

AUTOMATIC DEHYDRATORS—DRY AIR PUMPS—NITROGEN EQUIPMENT

Description	Cat. No.	Description	Cat. No.
Automatic dehydrator, motor driven, self-reactivating, output 1 1/4 cubic foot per minute. Use with 1/8" lines up to 40,000 feet, 1 5/8" lines up to 10,000 feet, 3 1/8" lines up to 2,500 feet, 6 1/8" lines up to 700 feet. Requires 115 volts, 60 cycles, 1250 watts peak.	1900	Fittings for oil pumped nitrogen tank. Includes diaphragm regulator valve, high and low pressure gauges, threaded adapters and ten feet of 1/4" copper tubing. Fits oil pumped nitrogen tank obtained on rental from Air Reduction Corporation, or any of the tanks listed below.	858
Spare parts kit for Type 1900. Includes diaphragm, V-belt, and other replaceable items.	1901	Cylinder of oil pumped dry nitrogen gas. 12.3 cubic feet. Price includes ownership of cylinder. When empty, obtain refill from local office of Air Reduction Corporation. Priced full.	L-10513-3
Dry air pump, contains indicating silica gel desiccant, easily reactivated. Output 26 cubic inches per stroke. Use with 3/8" cable up to 6,200 feet, 1/8" cable up to 1,000 feet, 1 5/8" cable up to 250 feet, 3 1/8" cable up to 70 feet.	878	Same as above, except 78 cubic feet. Priced full.	L-10513-6
Silica gel refill for Type 878 dry air pump. Net weight one pound.	210	Same as above, except 112 cubic feet. Priced full.	L-10513-5
Air drying hose; six foot length of transparent plastic tubing containing silica gel desiccant. Includes automobile tire pump to supply dry air to short lengths of coaxial cable. Also includes one Type 210.	879	Same as above, except 224 cubic feet. Priced full.	L-10513-8
Air drying hose, same as Type 879 except pump is not included.	K-14744	Gas distribution manifold; includes pressure gauge and needle valve for each outlet. Specify number of outlets required.	6600
		Line gassing kit, used for distributing gas to 2 lines in TV system.	T-4833

6 1/8" DIAMETER, RIGID TRANSMISSION LINE FOR UHF-TV

To quote on this size UHF transmission line, we would appreciate a sketch providing approximate installation details; such as height of tower, various bends, maximum operating power, etc. Quotation will follow promptly.

WR-1500 ALUMINUM WAVEGUIDE

Aluminum waveguide, WR-1500, 15" x 7 1/2" inside dimensions, 12 foot section.	M-14710	Adaptor from WR-1500 to 3 1/8" diameter Type 562 coaxial transmission line.	M-14713
E plane bend for WR-1500.	M-14711	Set of spring hangers for one 12 foot section of WR-1500.	M-14714
H plane bend for WR-1500.	M-14712		

WR-1150 ALUMINUM WAVEGUIDE

Aluminum waveguide, WR-1150, 11 1/2" x 5 3/4" inside dimensions, 12 foot section.	M-14715	Adaptor from WR-1150 to 3 1/8" diameter Type 562 coaxial transmission line.	M-14718
E plane bend for WR-1150.	M-14716	Set of spring hangers for one 12 foot section of WR-1150.	M-14719
H plane bend for WR-1150.	M-14717		

SOLID DIELECTRIC RF TRANSMISSION LINES

Amphenol coax cables have low-loss, flexible, polyethylene inner jacket, covered by copper shield; with tough, resistant vinyl outer jacket over-all. These cables are impervious to exposure, to acids, alkalis, oils, and gasoline. Solid dielectric coax finds many applications in the radio broadcast station, including sampling lines, monitor pickup lines, and power transmission lines. Flexibility and durability of this type line allow ease of installation and extended trouble-free service.

The chart below shows characteristics and dimensions.

AN No.	Nom. Imp.	Nom. mmfd/ft.	Wire Size	Dielectric O. D.	Cable O. D.	Cat. No.
RG-8/U	52	29.5	7/21	.285	.405	21-004
RG-9/U	51	30	7/21S	.280	.420	21-005
RG-11/U	75	20.5	7/26T	.285	.405	21-007
RG-12/U	75	20.5	7/26T	.285	*.475	21-008
RG-17/U	52	29.5	.188	.680	.870	21-013
RG-19/U	52	29.5	.250	.910	1.120	21-015
RG-22/U	95	16	Two 7/.0152	.285	.405	21-038
RG-22A/U	95	16	Two 7/.0152	.285	.420	21-148
RG-58/U	53.5	28.5	20	.116	.195	21-024
RG-58A/U	50	29	19/.0068	.116	.195	21-199
RG-59/U	73	21	22CW	.146	.242	21-025
.....	71	21.5	9	.680	.870	21-125

*Includes armor sheath over outer jacket.

S—silvered; T—tinned.



OPEN WIRE TRANSMISSION LINE

Very popular in radio broadcasting and certain types of high frequency operation is the open wire transmission line. When properly erected, open wire line requires little maintenance and is trouble-free. The problems that affect other types of transmission line, such as temperature changes or moisture, have little or no effect on open wire line. — Open wire line is impressive in appearance, as well as reliable and rugged. Whether for 250 watts or 150 kilowatts, you will find open wire worthy of consideration.

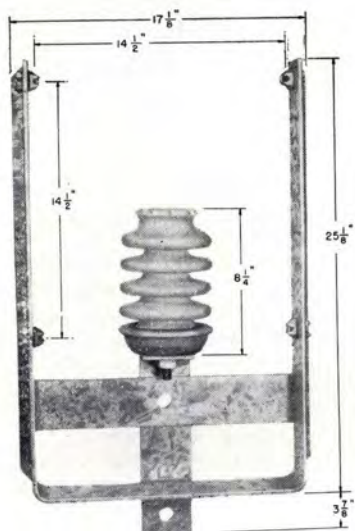

Transmission Line Bracket

(up to 150 kw)

A very rugged transmission line bracket for 5 or 6 wire line. Will not twist or change dimension under load of ice or wind. Hot dipped galvanized. Steel is $\frac{1}{4}$ " thick by 3" wide, with welded L section on side. Insulator is glazed wet process porcelain with corrugated design to prevent icing from shorting. Supplied with insulator and all hardware, ready to mount to pole. See impedance chart on next page for installation detail.

Transmission line bracket.

Cat. M-3327

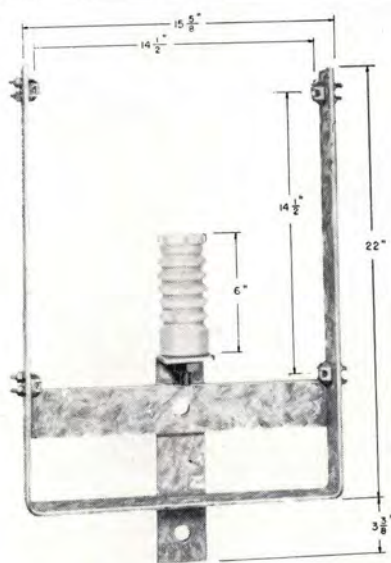

Transmission Line Bracket

(up to 50 kw)

Slightly lighter in construction than that illustrated above. Recommended for 250 watts up to 50 kw. Made of $\frac{1}{4}$ " by 3" steel, hot dipped galvanized. Insulator of Alsimag and corrugated to prevent leakage by ice formation. Installation and impedance chart is shown on opposite page. All hardware supplied.

Transmission line bracket.

Cat. M-2856

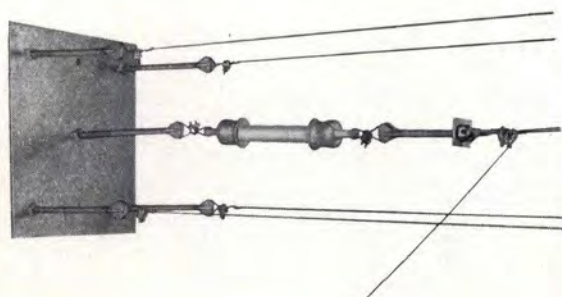

Transmission Line End Plate

For termination of the open wire line at each end, this end plate assembly with terminating strain insulator is used. Chart on opposite page illustrates method of mounting. Size is 20" square and $\frac{1}{4}$ " thick. Hot dipped galvanized—supplied with all hardware and insulator. Two types available, for up to 50 kw and up to 150 kw. 50 kw type has $15\frac{1}{2}$ " insulator and 150 kw has $25\frac{1}{2}$ " strain insulator. May be used for any lower power, of course.

End plate complete, for up to 50 kw.

Cat. M-2857

End plate complete, for up to 150 kw.

Cat. M-3328

OPEN WIRE TRANSMISSION LINE

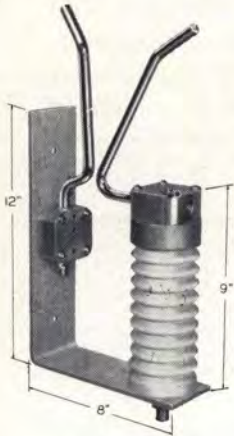

Horn Gap Assembly

A desirable part of the transmission line, particularly for higher powers. Connects to hot end of transmission line and ground to handle lightning and static discharges. Chart at bottom of page illustrates typical method of installation. For short transmission lines up to 200 feet, usually only one is required. For longer lines, install one at each end. Will handle up to 150 kw modulated. Insulator ceramic and arc gaps are heavy chrome plate. Bracket is hot dipped galvanized.

Horn gap assembly. Cat. M-3322



Center Post Assembly

The center post insulator has a variety of uses such as: (a) end or corner angling of transmission line, (b) support insulator for two wire line, (c) a support insulator for rhombic antenna, or (d) a guide insulator such as on end of building or coupling unit. Insulator, wet process porcelain, corrugated to prevent ice shorting. 20 3/4" high, 3" wide, 5" deep. Rating up to 150 kw modulated.

Center post assembly. Cat. M-3864

Entrance Bowl Insulators



A double bowl assembly for entrance into building or tuning house. Rating up to 50 kw at broadcast frequencies. Bowls of Alsimag. All hardware of heavy brass. Vellutex seals are provided for a weather-tight installation. Four types available, all identical other than stud length for various wall thickness.

- Feed-thru bowl, for wall up to 4" thick.
- Feed-thru bowl, for wall 4" to 8" thick.
- Feed-thru bowl, for wall 0" to 1" thick.
- Feed-thru bowl, for wall 8" to 10" thick.

- Cat. M-2870A
- Cat. M-2870B
- Cat. M-2870C
- Cat. M-2870D

MISCELLANEOUS MATERIALS

Gates has supplied material for all types of installations, including nearly 30 miles of open wire line in the Arctic, high powered installations on the sands of Africa, and many others. — Where design is special, Gates engineers will work with your engineers to determine your exact needs. Galvanized or wood mounting poles, wire, ground rods, turnbuckles and silver solder are often requested items. Gates will gladly quote on anything else necessary for the complete open wire installation.

Open Wire Design and Impedance Chart

Chart below illustrates typical five or six wire open type transmission line. Table is provided to show impedances with various wire sizes at certain heights above ground. Transmission line brackets may be either M-3327 or M-2856, end plate either M-2857 or M-3328. Horn gap is M-3322. The power, lighting and telephone circuits shown are optional, according to requirements of installation. Open wire line will average about the same per foot cost as 7/8" coaxial cable.

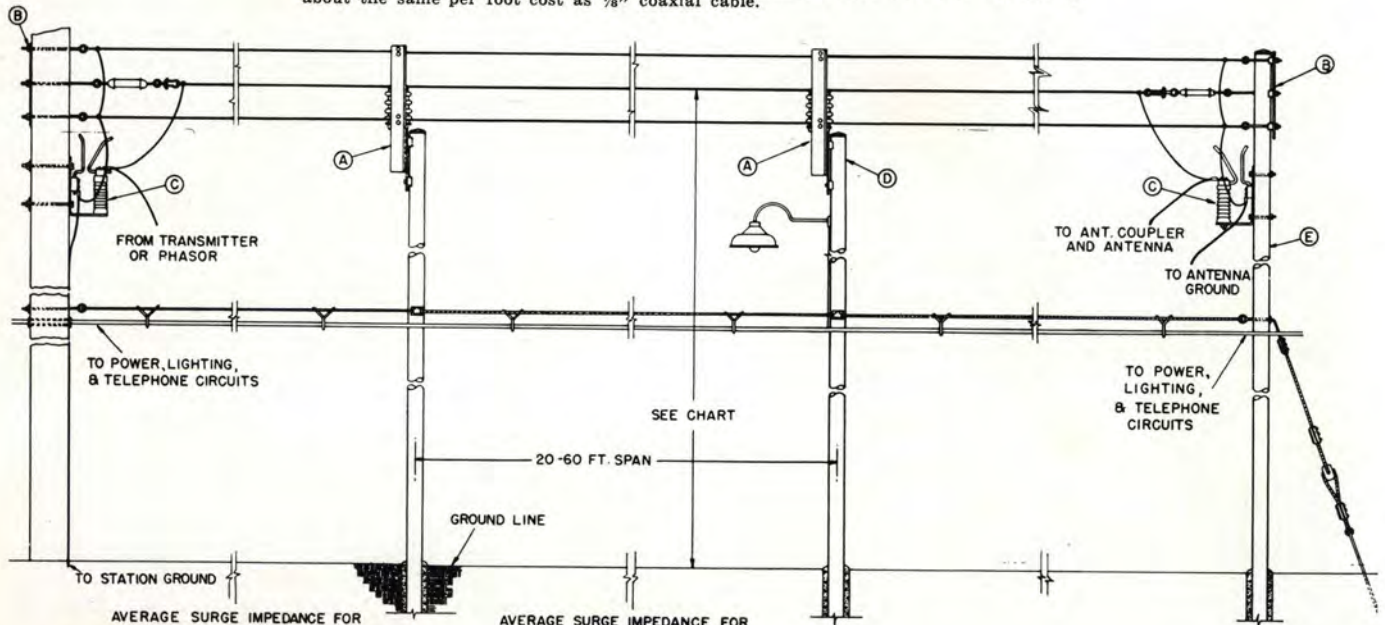

AVERAGE SURGE IMPEDANCE FOR 6 WIRE TRANSMISSION LINES

HEIGHT OF CENTER WIRE	WIRE SIZE		
	6	8	10
9'	232Ω	246Ω	250Ω
10'	234Ω	250Ω	256Ω
12'	240Ω	252Ω	260Ω

AVERAGE SURGE IMPEDANCE FOR 5 WIRE TRANSMISSION LINES

HEIGHT OF CENTER WIRE	WIRE SIZE		
	6	8	10
9'	330Ω	346Ω	364Ω
10'	333Ω	350Ω	365Ω
12'	332Ω	348Ω	363Ω

AUDITORY TRAINING SYSTEM

Designed specifically to assist the hard of hearing in classroom work or other gatherings. A built-in limiting amplifier increases the audibility and intelligibility of all sounds, regardless of the position of the microphones, or the distances of the microphones from the sound source. Fast limiting action minimizes the annoying and disturbing sounds such as exist in large gatherings. — Basic design consists of provision for four microphones, a self-contained 3-speed turntable, and several utility input sources. Dual meters provide adjustment for output level and amount of limiting action. Power of 16 watts supplies capacity for as many as 20 headphones at an acoustical level of 120 db—considered more than sufficient for sound reinforcement for the hard of hearing. — Sizable storage facilities in the lower part of the cabinet allow room for storage of headphones and records.

Auditory Training System complete, less headphones. Cat. CD-1



Plug-in amplifiers and power supplies are used throughout. Amplifiers are located directly behind drop-down front panel. Size is approximately 22" square and 36" high. Finished in medium gray.

For microphones, see pages 184, 185. Headphones, page 186. Special headphones such as pillow speakers, etc., are available. Full information sent on request.

Designed after months of research with one of the nation's leading specialists in the field of hearing problems.

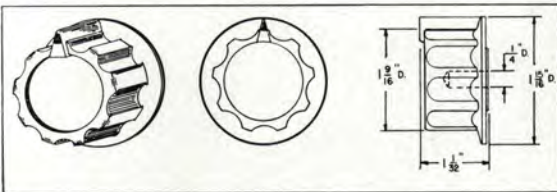
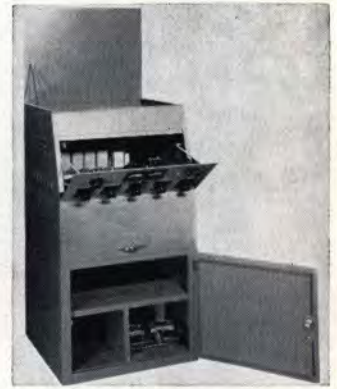

Gates Natural Grip Knobs

Now used on all Gates speech input consoles. Specially prepared by Gates designers to provide a natural finger grip, with absence of fatigue. Skirt design with index extrusion, easily located by touch, for exact rotation position. Has dual set screws, hardened brass insert, and fits right up to face of panel. Made of Tenite No. 2. Finish black. Face of knob will accommodate six different colors of decals as listed below. This provides full color indexing of various control functions.

Control Knob. Cat. GK-53

Color Decal Inserts for Knobs

This kit contains 30 decals. Five each of the following colors: red, green, blue, white, gold and silver. Fit in the face of the Gates natural grip control knobs described above.

Color Coding Kit for Knobs. Cat. DC-53

Plant Visitation

Visitors to our plant are always welcome. Likewise, broadcasters—both radio and TV—are invited to send their engineers to investigate Gates designs or receive helpful instruction on new equipment purchased. The Gates factories may be reached by air, vistadome streamliners, and numerous bus lines.

Installation Service

Arrangements can be made for installation supervision by qualified technical personnel who are fully instructed on Gates equipment. This is quoted on a per diem basis, plus travel and living expenses. Service includes all normal installation and testing functions, but excludes any service regularly performed by the consulting engineering profession.

Copper Ground Screen

For increased efficiency—reducing the dielectric losses in the ground immediately under the tower. Recommended as a requirement for a better radiated signal. 23 ga. split expanded copper. Each screen 8x24 feet.

Ground screen, per screen. Cat. GS-8

Copper Ground Wire

Standard No. 10 soft drawn copper wire. Comes in coils of about 200 lbs. Approximately 3000 feet to 100 lbs.

Copper Ground Wire, per cwt. Cat. W-10

Ground Rods

Available in two sizes. Both are steel copper weld with point for easy driving.

Rod 1/2"x6 ft. Cat. GR-6
Rod 3/4"x8 ft. Cat. GR-8

Insulators

Gates has hundreds of insulators of various types in stock, ranging from small post insulators to large feed-thru bowls. Tell us the length, diameter and other details.

Soldering Irons

Famous American Beauty, standard in the industry for years. Supplied with long heavy cord and stand.

60 watt soldering iron. Cat. 2128
100 watt soldering iron. Cat. 3138
200 watt soldering iron. Cat. 3158
300 watt soldering iron. Cat. 3178
550 watt soldering iron. Cat. 3198

Touch-Up Paint

Available in all colors to match Gates equipment. Supplied in pints only. Air dry for brushing or spraying. State color when ordering.

Touch-Up Paint, pint. Cat. PA-19

Lead-Covered Wire

Two-conductor, with a heavy lead sheath. For tower lights, remote metering, phasing switching, etc.

2-conductor No. 12 lead-covered wire. Cat. LE-2-12
2-conductor No. 18 lead-covered wire. Cat. LE-2-18

Ground Strap

Copper ground strap for brazing, transmitter grounds, etc. 0.026 thick.

Copper strap, 2" wide, per ft. Cat. CS-2
Copper strap, 4" wide, per ft. Cat. CS-4

Tower Lamps

For replacement of obstruction or beacon lights. All lamps are 120-125 volts to assure long life on 115 volt circuits. Type A21 is clear traffic, 100 watt with medium screw base. Type PS40 is a 500 watt clear beacon lamp with mogul pre-focus base.

Tower lamp, obstruction. Cat. LL-A21
Tower lamp, beacon. Cat. LL-PS40

Exhaust Fans

As exhaust fans vary in size, to comply with requirements, if you will let us know the size of your room, and give us a general description of the equipment therein—especially the size of the transmitter—we will be glad to quote on the fan you need. Many styles in stock.

General Hardware

In equipment installation, there is the need for a complete stock of special, as well as standard, hardware. We will be glad to quote on all sizes of nuts, bolts, door handles, catches, etc. (various materials and plating). Thousands of these items in stock.

GATES IN PICTURES



Quincy, Ill., Business District



Gates Plant No. 1 On Mississippi

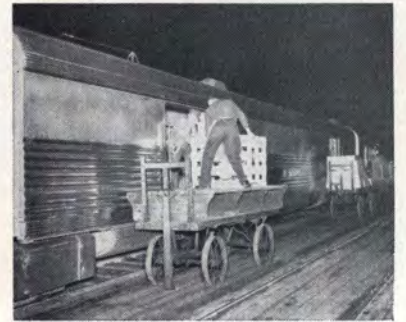

Ship By Express



Private Siding



Cabinet Making



Ship By Air



Carried in Stock



Gates Nine



Soap Box Winner



ABC Beauties



Gates Picnic



They Won It



Visitors From Pakistan

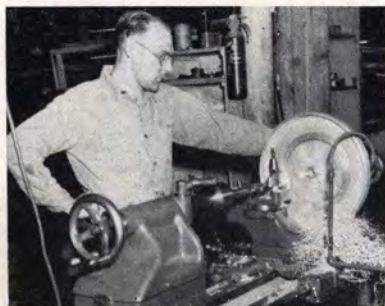

Turntables

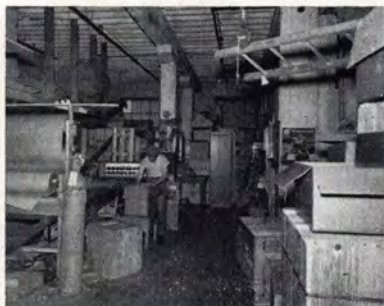

Pack Carefully



On Frequency

SPECIAL DESIGN EQUIPMENT

10,000-Watt Audio Amplifier

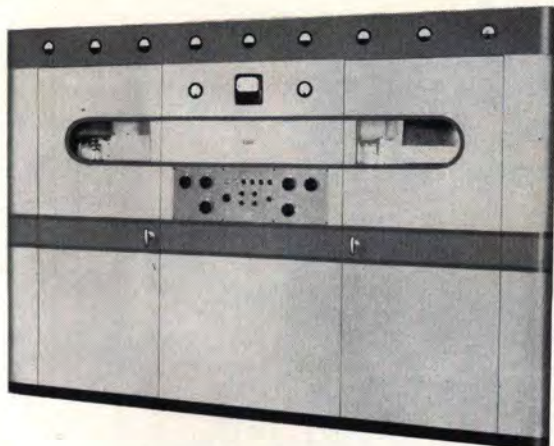

To the left and below is pictured a very unusual audio amplifier that will deliver 10,000 watts of audio power at less than 5% distortion. Designed primarily for fatigue service in driving dynamic vibrator to test materials under varying frequency and rigor of vibration. Though having many applications, it has been most valuable in the design of airplane propellers and other heavy aircraft parts. Output transformer design varies to customer demands. Typical design ranges from 1 ohm to 600 ohms output, providing high current low voltage or low current high voltage output. Amplifiers are available with or without direct reading wattmeter, as desired. — Gates engineers will be happy to plan with other engineering departments in the application of this equipment to fatigue service. Operates from 230 volts 3 phase current.

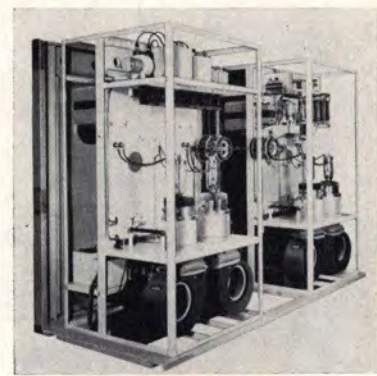
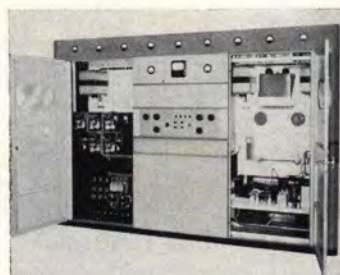

Gates 10,000 watt amplifier, 11' wide, 84" high and 50" deep. Employs four 892R audio amplifier tubes in the output stage.

1000-Watt Amplifier



This amplifier may be used as a modulator, large power amplifier for super public address service, or as a fatigue amplifier. Employs four 833A tubes in output stage. Output transformer may be according to customer's requirements, matching any desired impedance. Response may be restricted or linear.

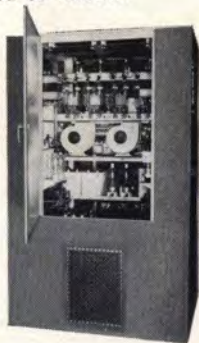

For heavy duty service, the Gates 1000 - watt amplifier stands 78" high, 40" wide and 36" deep. Operates from 220 volts single phase.

300-Watt Stadium Amplifier

In large stadiums, the use of a single high powered audio amplifier greatly reduces the amount of wiring to the loudspeaker system. This 300-watt unit provides wide response, low distortion, and plenty of peak power capacity. Standard output impedance is 500 ohms. Input is 0 dbm. Designed for continuous duty. May be used as modulator or fatigue amplifier with only slight modification in design.



Totalizing Recorder



This device counts the number of times a receiver or receivers have been actuated by a signal with a predetermined signal strength. Available in any number of channels. Unit illustrated has ten channels. Used in propagation measurements and other applications where recording of signal intensity, by visual means, is desired.



Complete Educational FM Station

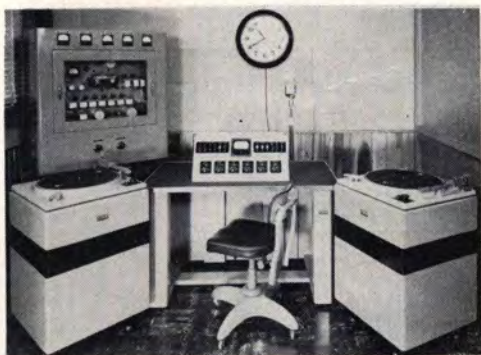

Page 37 of this catalog describes in detail the Gates BFE 10 ten-watt FM transmitter for educational purposes. The FCC will license any high school, college or university that is non-commercial, to operate in the regular FM broadcast band. Illustrated above is a typical complete educational installation. Let us plan with you to fit your exact budget requirements. You will be surprised at the modest cost for this complete radio station.

← Centralized Sound Systems

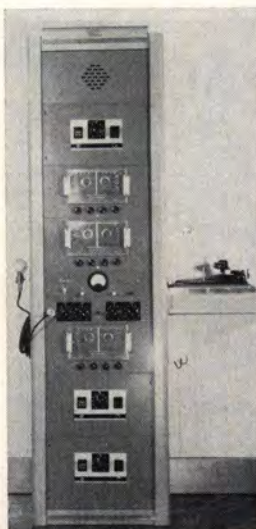

One of the many activities of the Gates special equipment section is the manufacture of custom design centralized sound systems. To the left is illustrated a 3 channel complete system for a modest-sized hospital or hotel. Available for any size installation, from a dozen to several hundred rooms. Let Gates engineers plan with you.

GUIDE FOR SELECTING RADIO STATION EQUIPMENT

EQUIPMENT FOR THE TYPICAL AM RADIO STATION

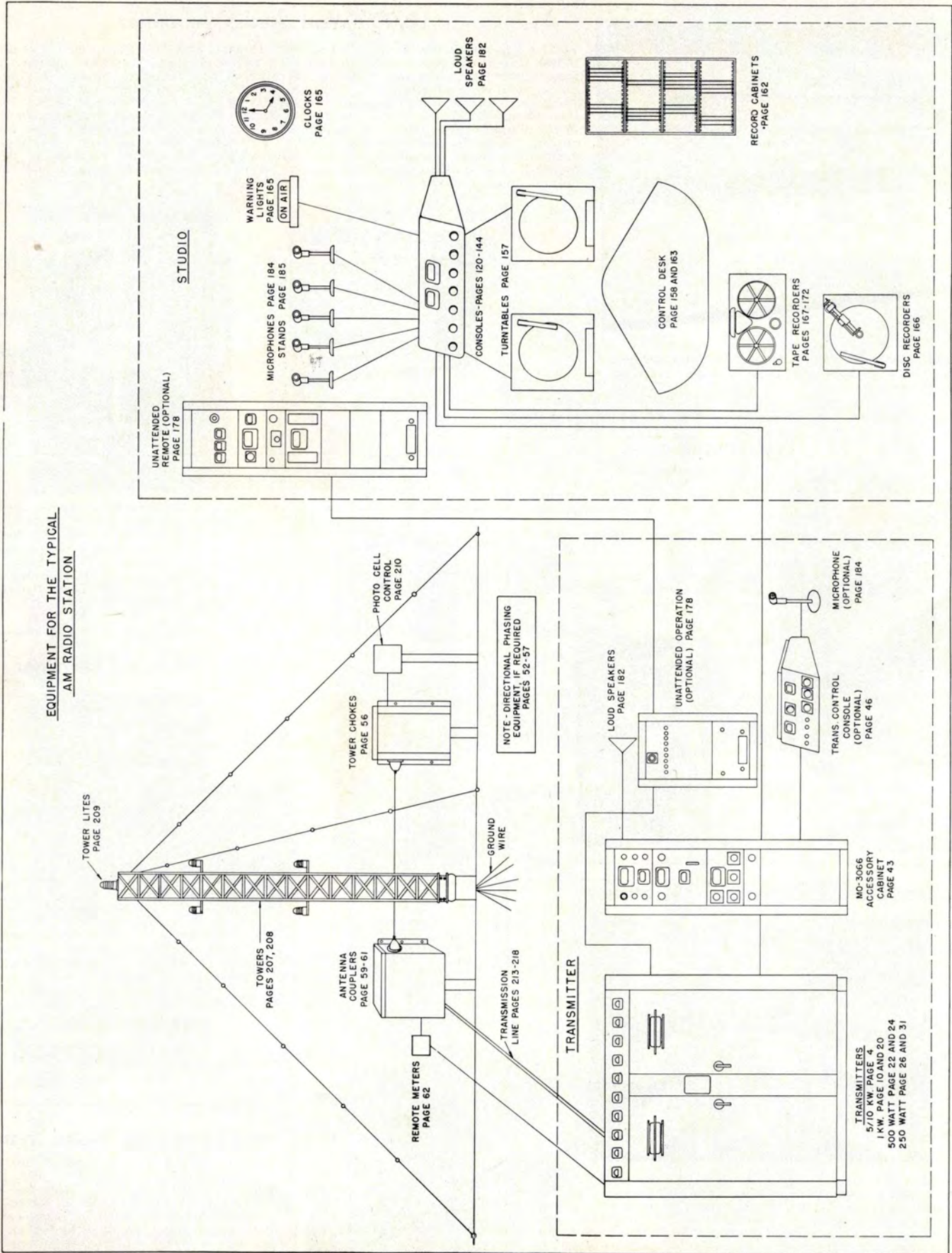

FLOOR PLANS AND BUILDING LAYOUTS

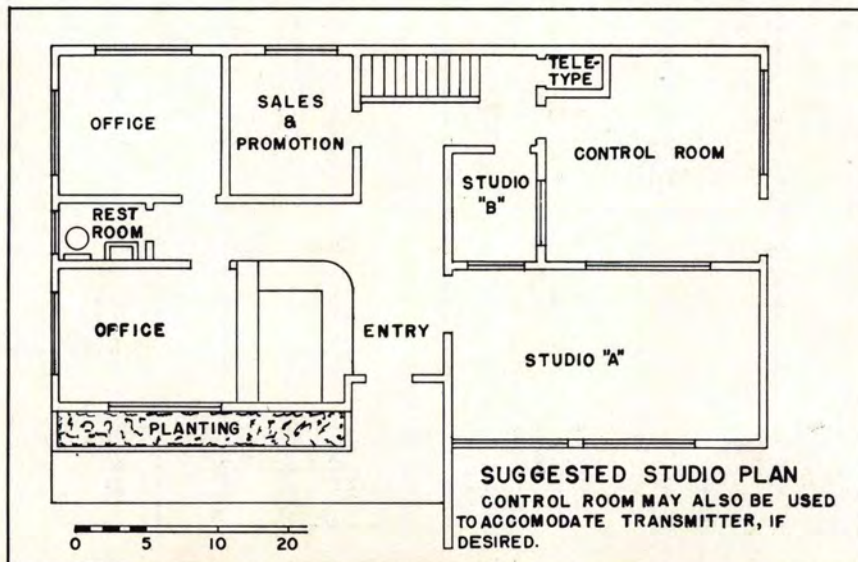
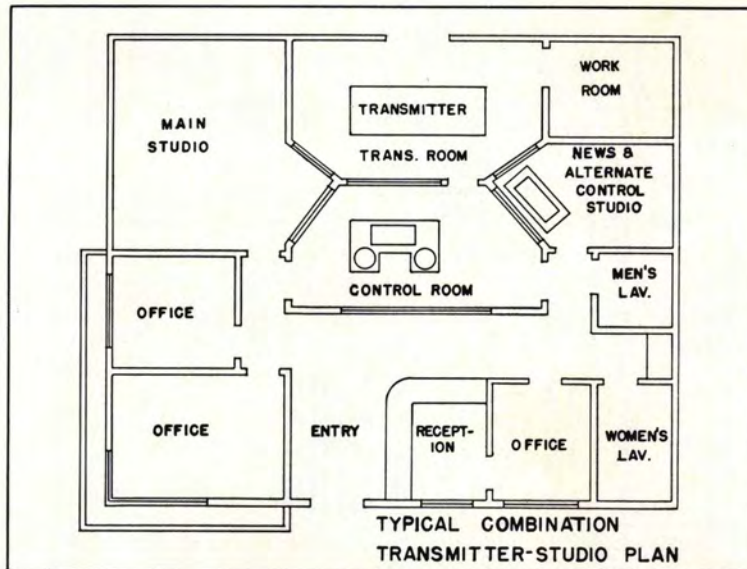
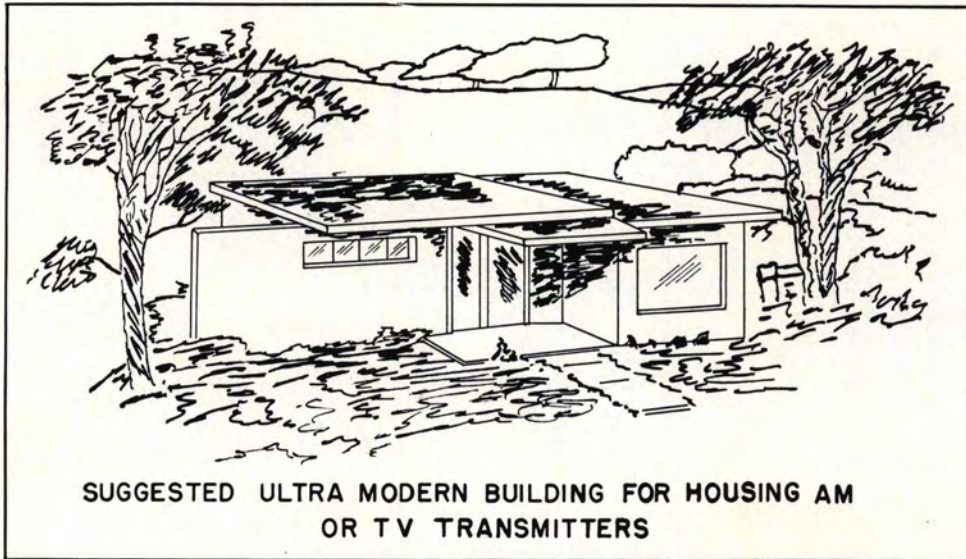

FUNCTIONAL DRAWING CCI CONSOLE

FUNCTIONAL DIAGRAM

TYPE CCI CONSOLE WITH ACCESSORIES

STANDARD CCI CONSOLE INCLUDES 2 BOOSTER AMPS, 1 PROGRAM AMP, 1 MONITOR AMP, 2 POWER SUPPLIES, 1 PANEL AND SHELF ASSEMBLY, AND 3 RELAYS. ALL OTHER EQUIPMENT IN THIS DRAWING IS EXTRA.

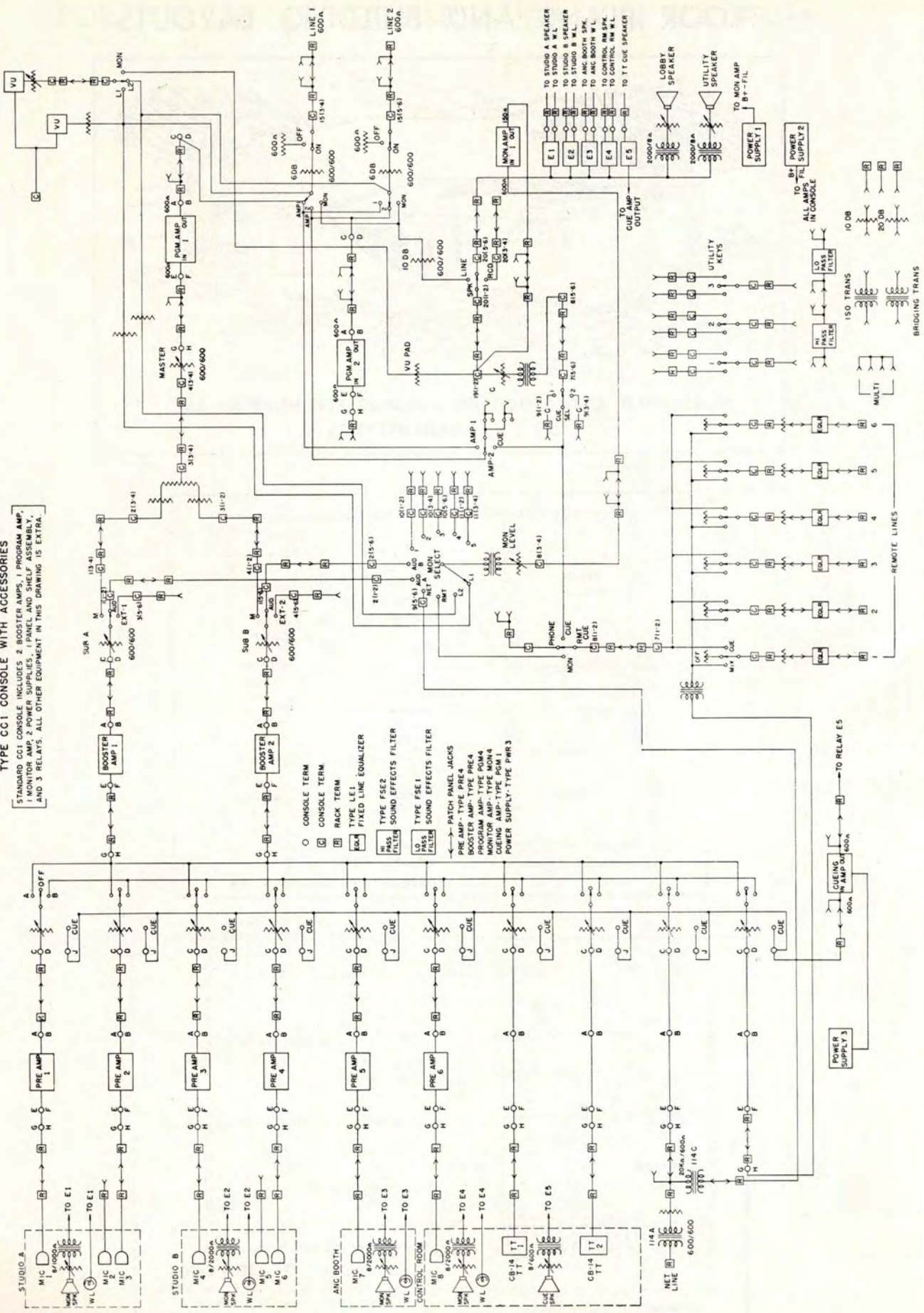

See pages 120 through 126 for equipment referred to above.

**FUNCTIONAL DIAGRAM
TYPICAL TAPE RECORDING SYSTEM**
USING GATES 52CS STUDIOETTE WITH EXTERNAL
EQUIPMENT.

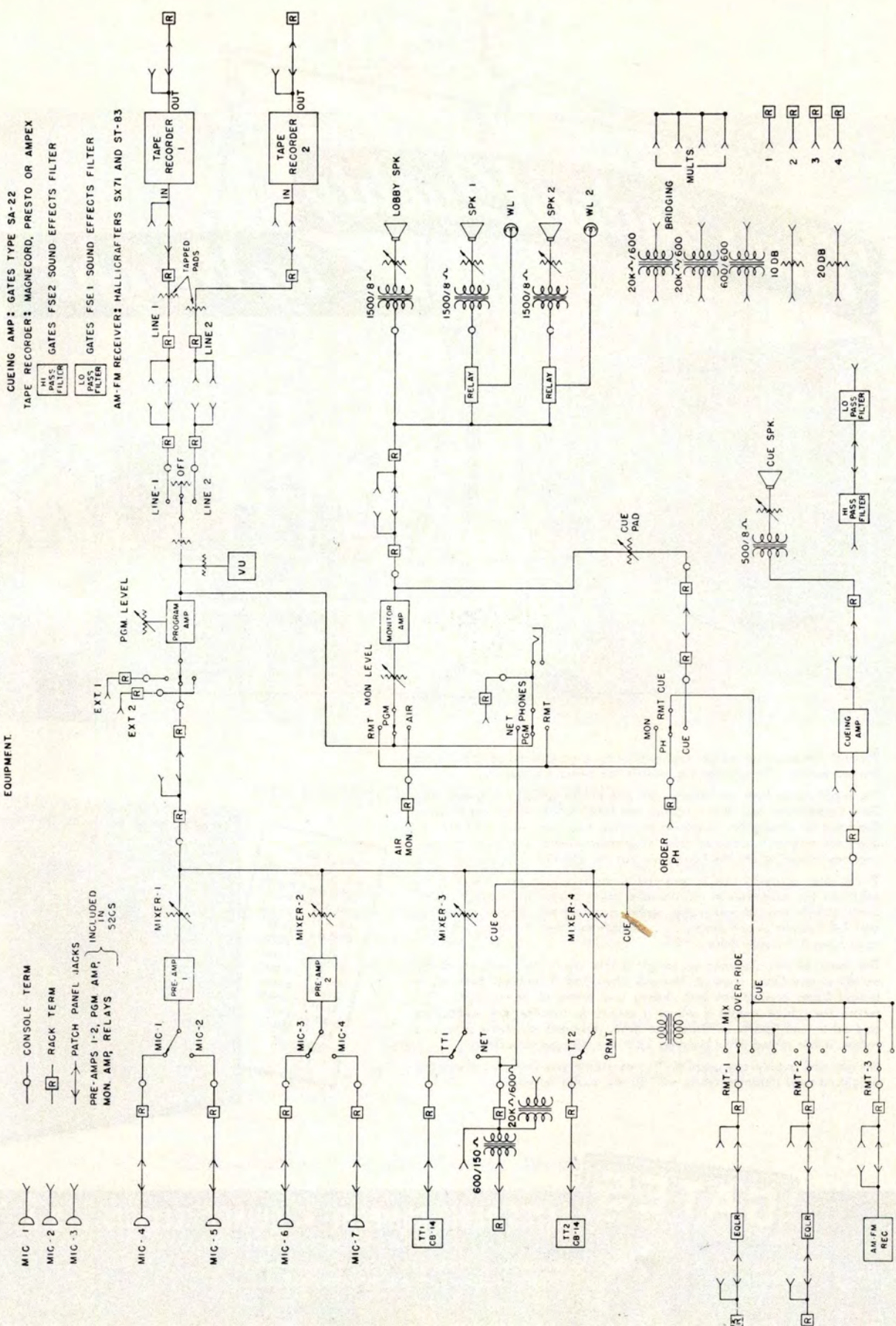

CUEING AMP: GATES TYPE SA-22
TAPE RECORDER: MAGNACORD, PRESTO OR AMPEX
GATES FSE2 SOUND EFFECTS FILTER
GATES FSE1 SOUND EFFECTS FILTER
AM-FM RECEIVER: HALLICRAFTERS SX71 AND ST-83

MIC 1-3 } INCLUDED IN 52CS
MIC 4-7 }
MIXER 1-4 }
PRE-AMP 1-2 }
MON. AMP RELAYS }
CONSOLE TERM }
RACK TERM }
PATCH PANEL JACKS }
PRE-AMPS 1-2, PGM AMP }
MON. AMP RELAYS }
52CS

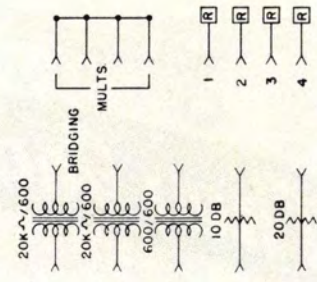

Suggested complete tape recording layout.

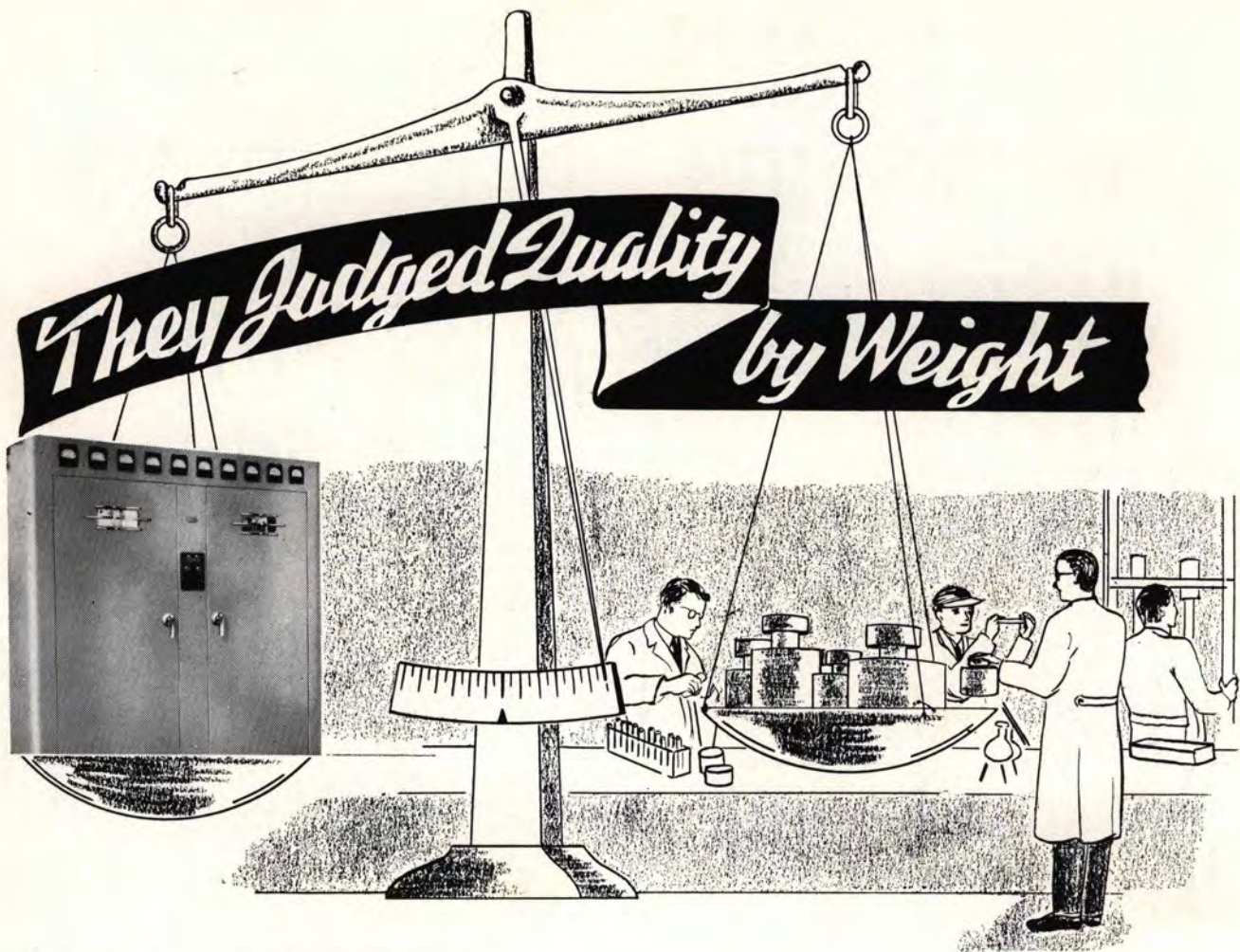

Through the centuries weight and quality have gone hand in hand. With few exceptions, the greater the weight the better the quality.

The super ocean liner was always the one of the greatest tonnage. The 5000 horsepower locomotive pulling one hundred car trains was heavier. Gold is even among the weightiest of metals and, yes, even the finer airliners are largely superior because of greater weight. There are few exceptions indeed where the heaviest is not the greatest in its class.

This is most assuredly true in commercial radio equipment. There is no substitute for more iron in transformers, more copper in windings, additional shields around vulnerable audio transformers, larger capacitors and full-fledged circuit design . . . weightwise, that is. In short, you can't have it if it isn't there.

The moral of this discourse on weight is this: We invite you to check the weight of any Gates product. You will often find it heavier. Even so, a typical Gates product has both chassis and panel of aluminum. — This means the added weight is where it counts, in transformers, capacitors and other husky parts. — Gates has never designed to meet a price . . . rather, it has priced after bringing forth the best possible design.

Weight and quality are parallel. The next time you buy . . . check the weight. In most instances Gates will tip the scales heaviest.

GATES BC-1F
 Air-Conditioned
 1000 watt broad-
 cast transmitter,
 weight packed
 2650 lbs, size 78"
 high, 72" wide,
 33" deep. Broad-
 casting's largest,
 heaviest quality-
 filled broad-
 cast transmit-
 ter in the
 1000 watt
 field.



GATES

GATES RADIO COMPANY • QUINCY, ILLINOIS, U. S. A.
 manufacturing engineers since 1922

2700 Polk Avenue, Houston, Texas — Warner Building, Washington, D. C. — International Division, 13 E. 40th St., New York City
 Canadian Marconi Company, Montreal, Quebec

GATES



TELEVISION BY GATES

The following several pages list and illustrate several television transmitters and other associated television equipment manufactured and sold by Gates. Preceding pages describe modern speech input equipment, and many other equipments and accessories that are standard items in television transmission of sight and sound.

Gates will soon release a complete and separate catalog with a much more extensive listing of everything needed for the complete TV station, large or small. — Watch Gates for big things in TV. For further information write any Gates office listed below.

Gates Radio Company, Quincy, Illinois, U. S. A.

- In New York City: 51 E. 42nd Street, Telephone Murray Hill 7-7971.
- In Washington, D. C.: Warner Building, Telephone Metropolitan 8-0522.
- In Houston, Texas: 2700 Polk Avenue, Telephone Atwood 8536.
- In Atlanta, Ga.: Spring at 13th Street.*
- In Canada, Montreal, Que.: Canadian Marconi Co., Telephone Atlantic 9441.
- (Export) in New York: 13 E. 40th Street, Telephone Murray Hill 9-0200.
- In Los Angeles, California: 7501 Sunset Blvd.*

*After Sept. 1, 1953.

500 WATT VHF GATES MODEL BT1A

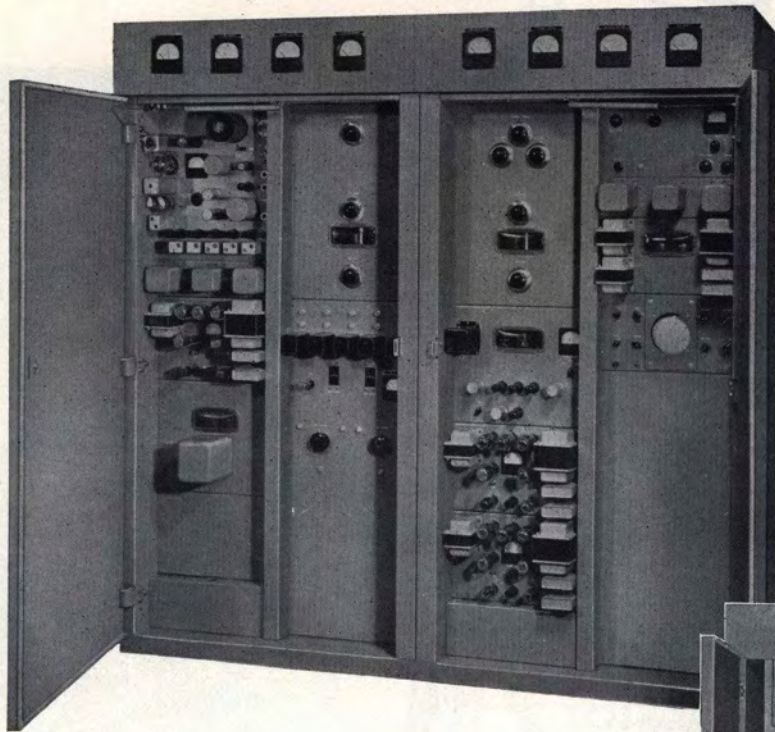

FOR MODERN SPEECH
EQUIPMENT FOR TV,
SEE PAGE 120.

Gates TV model BT1A: 500-watt visual,
250-watt aural, and exciter for all higher
power VHF TV transmitters.

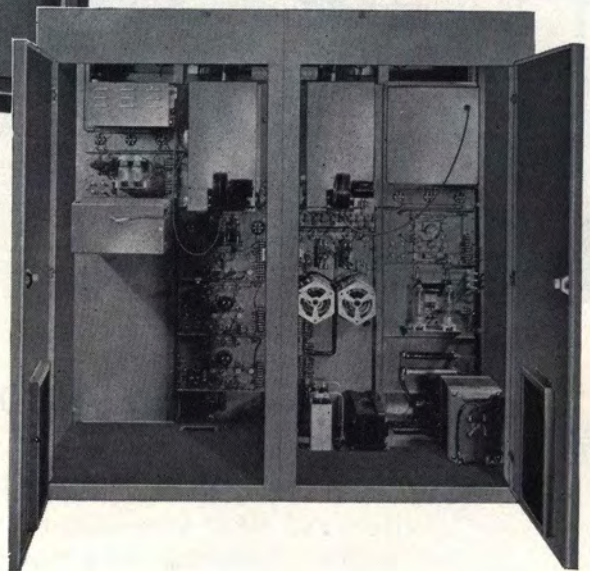

Roomy, easy-to-service design is a must in TV. — For the engineer with a full knowledge of TV, or the engineer who must yet acquire familiarity—the ease of servicing, tracing of circuits, and quick accessibility of all parts in the new Gates BT1A TV transmitter will be appreciated.

The Gates BT1A has built-in wave form and modulation monitor for the visual transmitter, a mighty important feature that is often an extra with other transmitters. — If going to higher power, of course, the BT1A is basic for the Gates BT5A 5000-watt transmitter, described on the opposite page. — For full specifications, see Page 230.

For channels 2-6.
For channels 7-13.
100% set of spare tubes.

Cat. BT1A-L
Cat. BT1A-H
Cat. TK-160

5000 WATT VHF GATES MODEL BT5A

Five kilowatts of visual power along with 2500 watts of aural power are now developed in a straightforward manner by the new Gates BT5A TV transmitter. — This large, roomy transmitter is a TV engineer's delight in serviceability, ease of maintenance and performance. The four cubicles comprising the BT5A include everything except the side band filter. Size overall: 174" wide by 35" deep and 78" high. Full size front and back doors. Metering is generous, 30 in all, with no meter switching in important circuits.

Dual powerstats (continuously variable auto transformers) control all filaments and high voltage. This allows direct primary control providing a wide variation to cover any sagging or over-ambitious primary supply. — A high pressure turbine type blower supplies a great excess of air to the four 3X2500A3 power tubes used in the visual and aural power amplifiers.

Backed by a wealth of experience in the design of high frequency transmitting equipment, Gates engineers have provided a 5 kilowatt TV transmitter that will perform at top efficiency with minimum servicing, and with an abundance of mechanical and electrical features which have made Gates' leadership a well known fact throughout the broadcasting industry.

Technical specifications, next page.

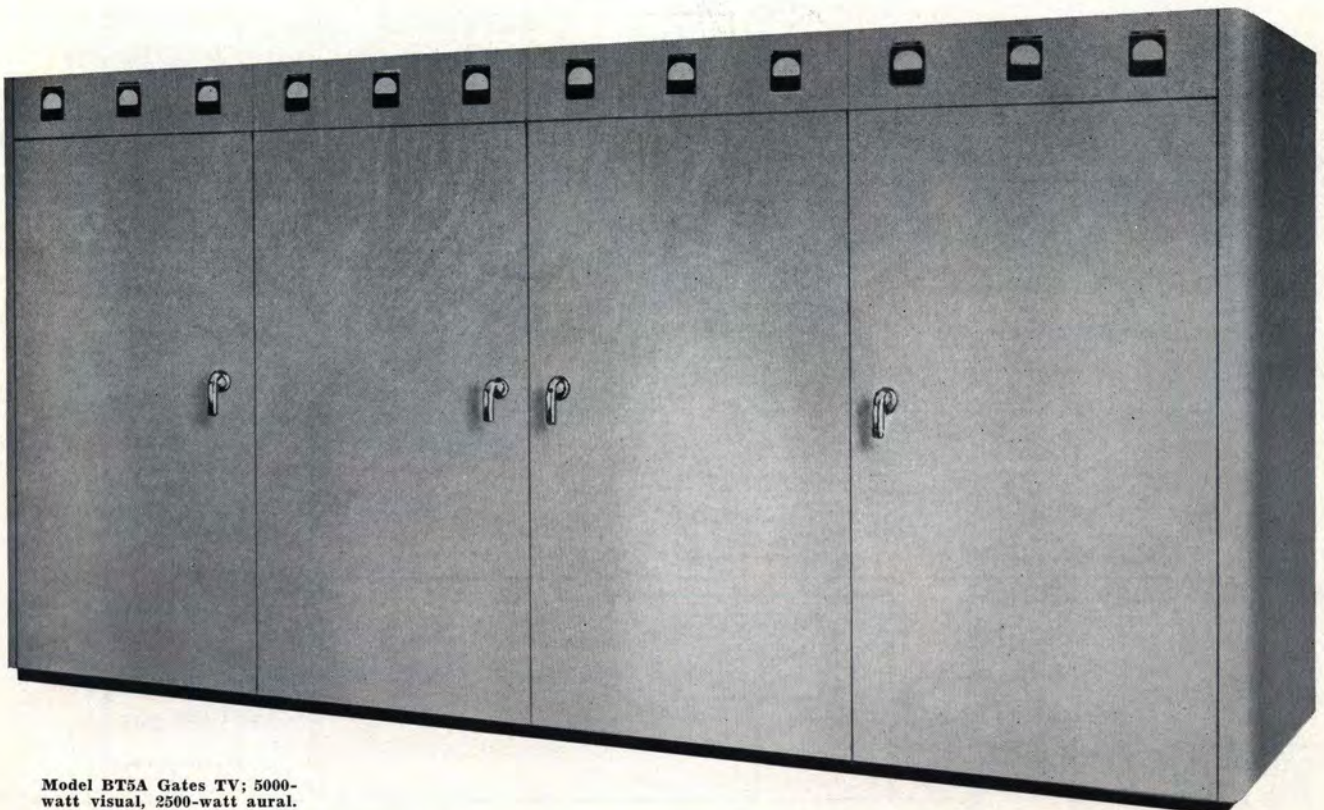

Model BT5A Gates TV; 5000-watt visual, 2500-watt aural.

For channels 2-6.
For channels 7-13.
100% set of spare tubes.

Cat. BT5A-L
Cat. BT5A-H
Cat. TK-161

SPECIFICATIONS GATES VHF TV TRANSMITTERS

Since the BT1A is a basic part of the BT5A, specifications which are given for the BT1A also hold true for the BT5A.

Model BT1A (500 watt VHF)

- POWER OUTPUT**—Visual: 500 watts. Aural: 250 to 500 watts.
- PRIMARY REQUIREMENTS**—230 volts, single phase, two wire, load 14½ amperes.
- SIZE**—89" wide, 78" high, 35" deep.
- R. F. OUTPUT**—51.5 ohms, both visual and aural.
- MODULATION CAPACITY**—Aural: 100% = 25 kc swing, but capable of 40 kc swing. Visual: 90%.
- RESPONSE**—Aural: ±1½ db 50-15,000 cycles.
 Visual: ±2 db at 0.5 mc.
 ±2 db at 1.25 mc.
 ±2 db at 2.0 mc.
 ±2 db at 3.0 mc.
 ±3 db at 4.0 mc.
- INPUT LEVEL**—Aural: +10 dbm.
 Visual: approximately 2 volts peak to peak.
- CARRIER STABILITY**—Aural: .002% direct crystal control.
 Visual: .002% direct crystal control.
- NOISE (or amplitude variation over 1 frame)**—
 Aural: -60 db FM or -50 db AM.
 Visual: less than 5% of sync. peak level.

- INPUT IMPEDANCE**—Visual: 75 ohms.
 Aural: 600 ohms.
- TYPE OF MODULATION**—Aural: phase shift.
 Visual: grid amplitude modulation.
- MONITORS**—Built-in wave form and modulation monitor for visual section.
 Built-in power and standing wave ratio monitors for both visual and aural transmitters.
- RANGE**—Channels 2 through 13.
- TUBES**—9, 6AS7; 6 each, 6AG7, 5U4G; 5 each, VR105, 6SJ7; 4 each, 4/400A, 12AY7; 3 each, 6SH7, 6BG6G; 2 each, 815, 829B, 866A, 8008; 1 each, 6V6, 6SN7, 12AX7, 6BA6, 6X5, 5BP1A, 1X2, 6X4.

Model BT5A (5000 watt VHF)

- POWER OUTPUT**—Visual: 5000 watts.
 Aural: 2500 watts.
- SIZE**—174" wide, 78" high, 35" deep.
- RESPONSE**—Aural: ±1½ db 50-15,000 cycles.
 Visual: ±2 db at 0.5 mc.
 ±2 db at 1.25 mc.
 ±2 db at 2.0 mc.
 ±3 db at 3.0 mc.
 ±4 db at 4.0 mc.
- TUBES**—6 each, 8008, 6AS7; 4 each, 3X2500A3, 5U4G, VR105; 2, 6SH7; plus all tubes as used in Model BT1A above.
- Note—All other data essentially same as Model BT1A listed above.

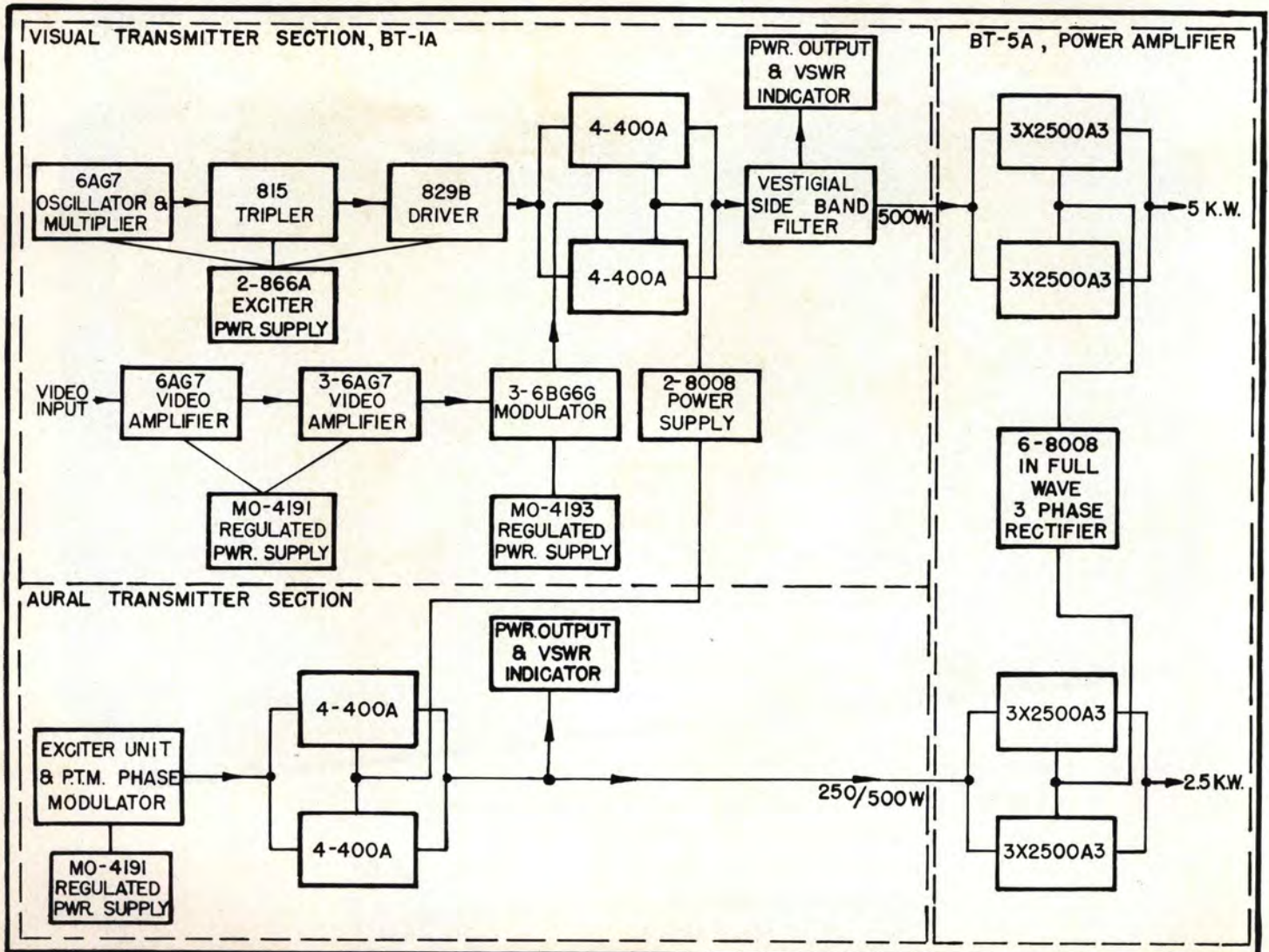

BT-1000A UHF Television Transmitter

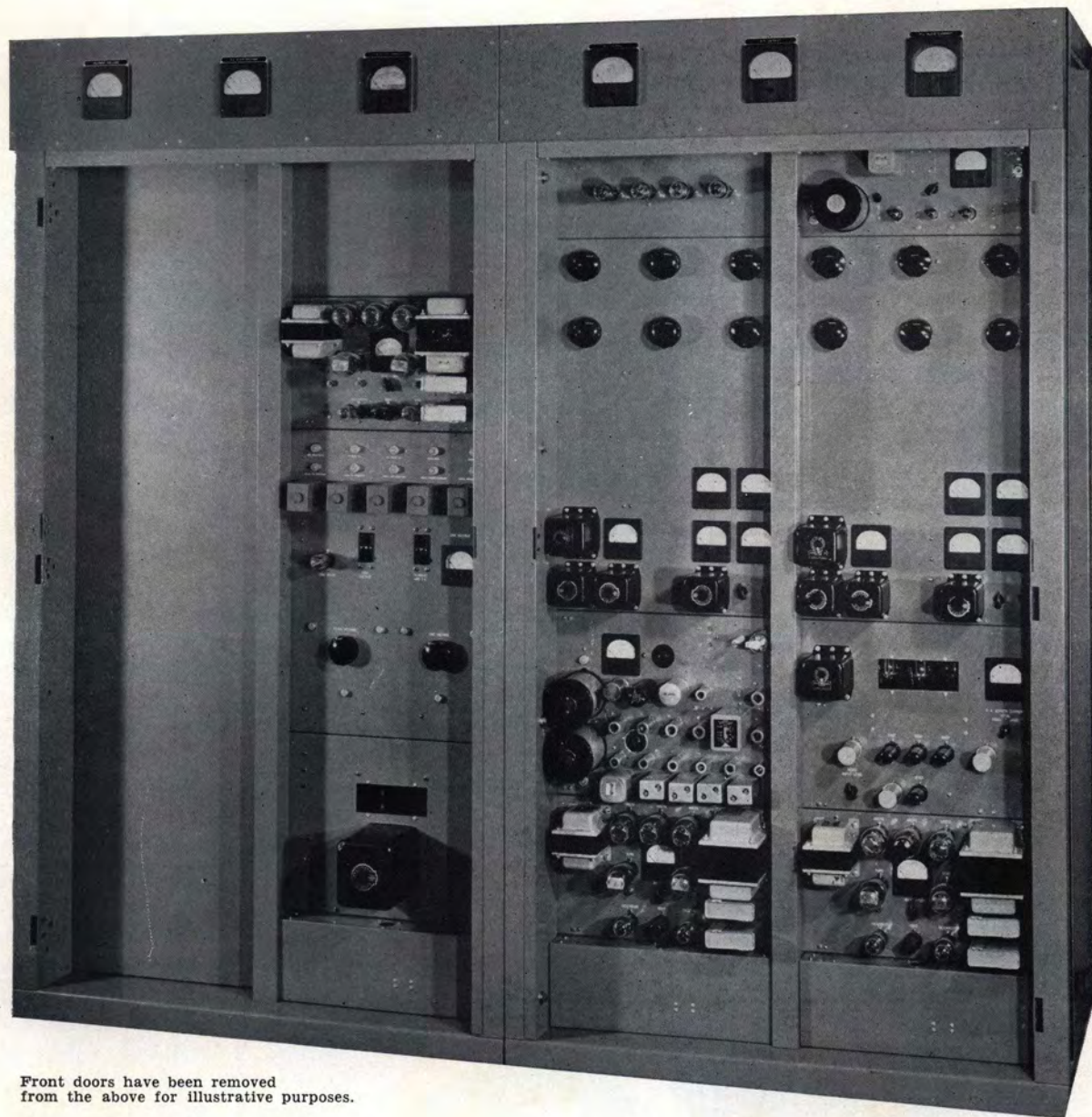

Front doors have been removed from the above for illustrative purposes.

Under development in the Gates laboratories for over a year, this new 1000 watt UHF television transmitter will soon be offered to the industry. It is designed along the same rugged material and performance specifications as the equipment that has made Gates the world leader in AM broadcast transmitter sales. The BT-1000A transmitter is sectionalized into a 100 watt exciter, that may also be utilized as a 100 watt transmitter, and a 1000 watt amplifier—both combined in the above enclosure. Also, the use of the BT-1000A transmitter is excellent as an exciter unit for higher powers when these become practical and economically feasible.

GATES BT-1000A UHF TELEVISION TRANSMITTER

Cubicles are of heavy construction, with full size front and rear doors. Sides are removable for ease in installation or servicing. Mechanical design includes micrometer machining and symmetrical electrical layout, combined with practical engineering, assuring easy access to every part, large or small. Particular attention has been given to cooling of power tubes so these tubes will provide maximum life. Metering is generous. Six large major meters are across the top, while 17 three-inch meters eliminate multimetering to assist greatly in tune-up and touch-up procedures.

Specifications

- EMISSION—Visual: A5; Aural: F5.
- FREQUENCY RANGE—Channels 14-83.
- POWER OUTPUT—1000 watts peak visual, 600 watts aural.
- R. F. OUTPUT IMPEDANCE—50 ohms visual and aural.
- CARRIER STABILITY—0.0001%.
- MODULATION CAPACITY—Visual: 85%; Aural: ± 40 kc.
- METHOD OF MODULATION—Visual: amplitude grid modulation of power amplifier stage.
Aural: phase, employing pulse timing circuits.
- INPUT IMPEDANCE—Visual: 75 ohms; Aural: 600/150 ohms.
- VISUAL RESPONSE— ± 2 db at 500 kc.
 ± 2 db at 1.5 mc.
 ± 2 db at 2 mc.
 ± 2 db at 3 mc.
 ± 3 db at 4 mc.
- AURAL RESPONSE— $\pm 1\frac{1}{2}$ db 50-15,000 cycles.
- DISTORTION— $1\frac{1}{2}\%$ maximum.
- NOISE LEVEL—FM: 55 db below 100% modulation.
AM: 50 db below 100% modulation.
- SIZE—87" wide, 78" high, 35" deep; door swing excluded.

UHF 1000 watt transmitter with one set of tubes, 4 crystals and ovens, and nominal installation materials.

100% set spare tubes for BT-1000A transmitter.

Cat. BT-1000A

Cat. TK-162

Specifications on this page are preliminary; and subject to change by the Gates Company, for either mechanical or electrical improvements, without notice either prior or subsequent to purchase.

NEW CC1 TV CONSOLE FULLY
DESCRIBED ON PAGE 120

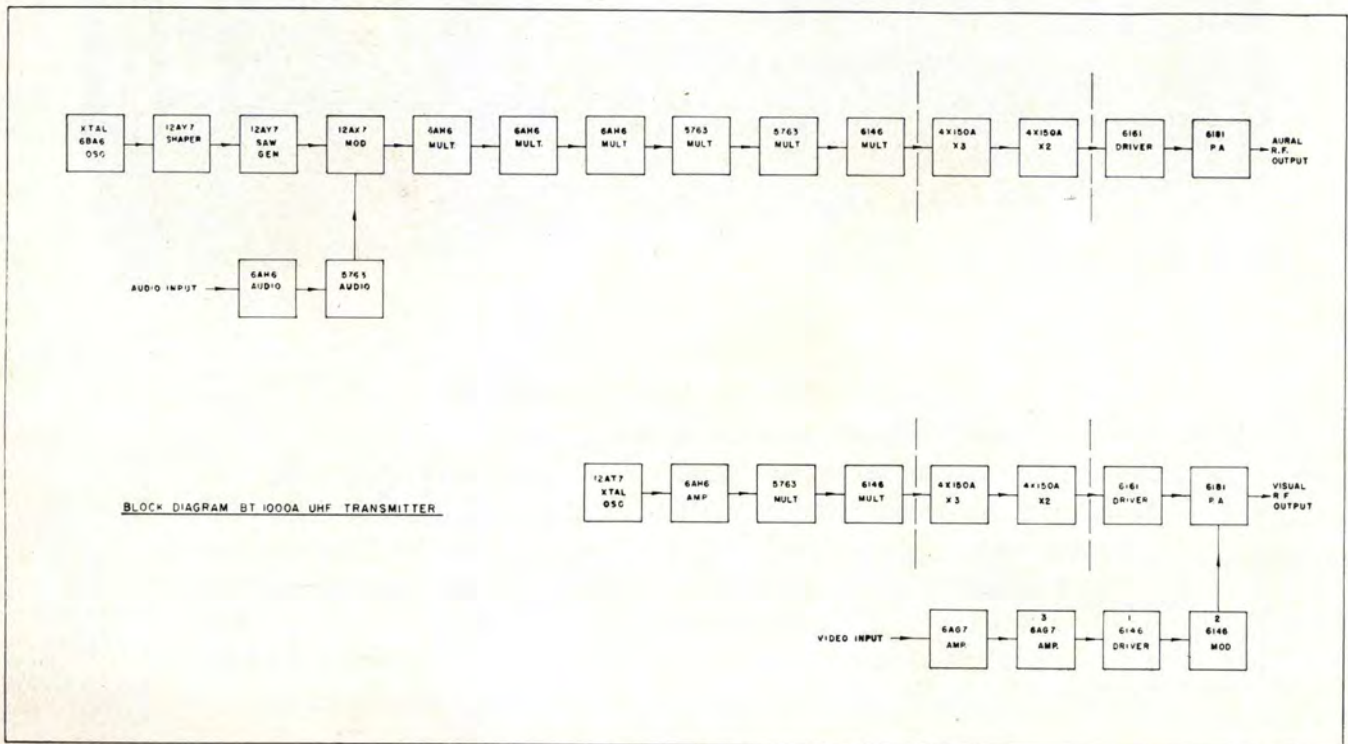

Block diagram Gates BT-1000A UHF television transmitter.

Holmes 16MM Television Projector

The Holmes 16 mm Television Projector is designed to project standard 16 mm sound films, which use a frame frequency of 24 frames per second, into a television pickup tube, either Iconoscope or Image Orthicon, which operates at a repetition frequency of 60 fields per second or 30 interlaced frames per second. Each time the picture is projected, the video signal is generated by the usual television scanning. Conversion from 24 to 30 frames, as required for TV, is accomplished by having one frame scanned twice. The 60 light impulses required each second, one for each vertical blanking period, are provided by a single shutter with 2 apertures. This revolves 1800 RPM and, with 2 openings, produces 60 light pulses per second.

For Image Orthicon pickup, the projector is equipped with shutter openings which transmit light somewhat longer than standard vertical blanking time. The characteristics of the Orthicon chain are such that the effect of this longer light pulse is eliminated. Iconoscope projection requires the use of a light mask in the projector. The Holmes design copes with both of these situations excellently.

Sound pickup combines excellent fidelity with top mechanical design. The result is fine quality, free from wow and flutter. It is impossible to thread this projector out of synchronism. No tools are required to change exciter lamps. The sound pickup unit is completely shock mounted to prevent extraneous vibrations from affecting the pickup quality. A 3-stage preamplifier attaches to the photocell, which has high resistance when dark. Output matches standard mixer impedances, and preamplifier has power supply self-contained.

Controls have been simplified. The circuit breaker acts, also, as the master switch. Two additional switches control motor and projection lamp. A remote control switch and pilot lamp operate in conjunction with a remote system incorporated in the projector. A

1000 watt projection lamp is standard equipment. However, 500 or 750 watt lamps may be alternately supplied. A spare lamp socket is standard equipment for quick change.

Bausch and Lomb Super Cinephor lenses are used exclusively. Speed of lenses are f1.6 regardless of focal length. A 2" lens is standard with the projector. Other focal lengths are available, and are listed on page 234 as accessories.

Air Cooled Aperture: Note, in the illustration below, the motor (on top) which feeds an air blast to the aperture gate and plate. This is why as much as 4000 feet of film may be used without any part heating. It also eliminates the need for light-reducing, heat-absorbing glass, often used in projectors in place of air cooling of the aperture. This added feature keeps the projector always cool; and allows a new film to be threaded instantly after the completion of even a 4000' 1 hour 45 minute film. The projector is never too warm handle.

(continued next page)

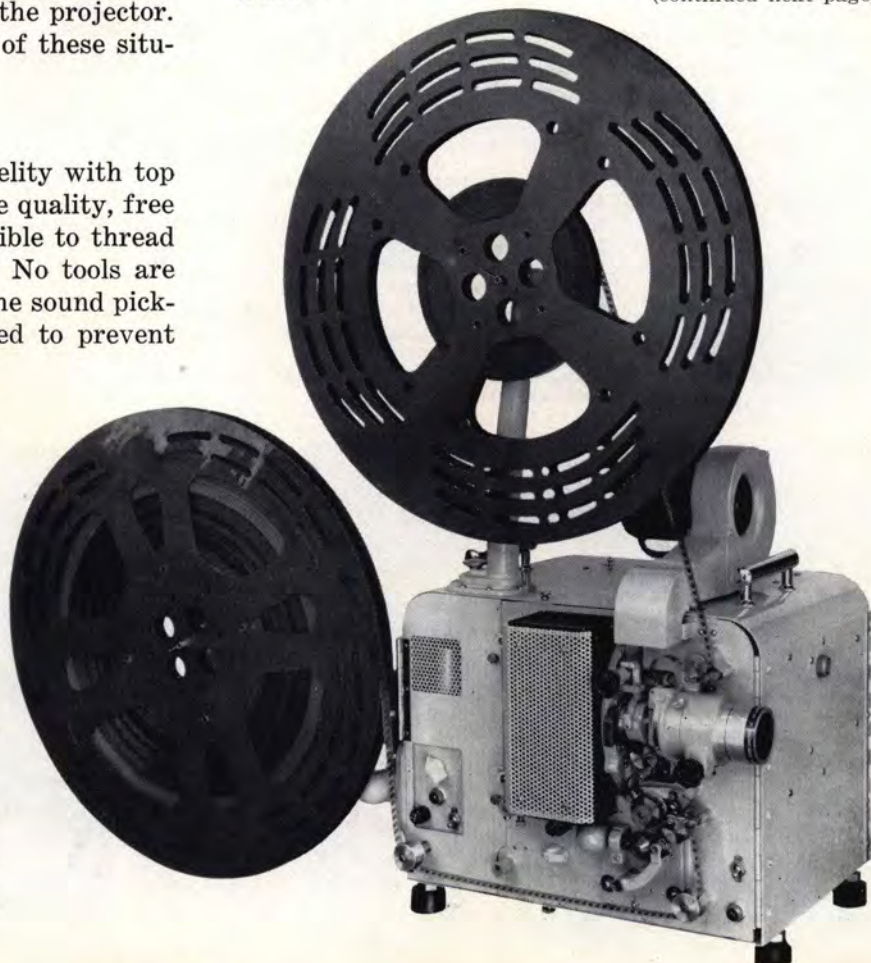

Holmes 16MM Television Projector

Decimittent Movement: A new design with the cam so built that the film pull-down speed can be set to meet television projection requirements. Speed of pull-down is 1/337th part of a second or 2968 microseconds. For long life, large 10-tooth sprockets engage four film perforations.

Mechanical Construction: Fabricated from 14 gg Wellsville polished steel, reinforced with angles and channel ribs, and welded. Weight has not been sacrificed as vibration-free operation is mandatory in good TV projection. Feed and takeup reels are aluminum castings with 4000' reel capacity. Four rubber mounting feet are adjustable for leveling or tilting the projector. These feet are drilled from underneath in case the projector is to be bolted to a table or pedestal. Preamplifier and tubes are available on the threading side of the projector. Motor is 1800 RPM synchronous for 107-117 volt 60 cycle operation.

Phasing: Motor, by throwing one switch, may be phased 180 degrees. Manually operated phasing device also provided. A handwheel allows fine micrometer adjustment of phasing in both directions.

Specifications

SIZE—15¼"x16½"x15¼" high.
 HEIGHT OF LENS—10⅞".
 LAMPS—Two 1000 watt T12 medium
 prefocus.
 PHOTOCELL—No. 927.
 WEIGHT—Unpacked 95 lbs.
 FILM CAPACITY—4000'.

EXCITER—7½ amp, 4 volt, T5.
 AMPLIFIER OUTPUT—
 +5 VU. Noise 50 db below +5 VU.
 Distortion 1%. Gain 65 db. Out-
 put 50, 250, 500 ohms.
 TUBES—One each 5879, 12AX7, 6V6GT,
 5Y3GT.

Ordering Detail

Complete projector, with 2" lens, lamps, tubes, one 1600' reel.
 Remote control unit for above.
 3 point pedestal for floor mounting with 3" tilting adjustment.
 2½" lens, speed F1.6.
 3" lens, speed F1.6.
 3½" lens, speed F1.6.
 4" lens, speed F1.6.
 Shadow box for Image Orthicon (includes dual stand, image inverter).

Dual stand with image inverter for Iconoscope projection.
 4000' empty reel.

Cat. LT-16
 Cat. LR-16
 Cat. LP-16
 Cat. LL-2½
 Cat. LL-3
 Cat. LL-3½
 Cat. LL-4
 Cat. LSB-16
 Cat. LIP-16
 Cat. LRR-16

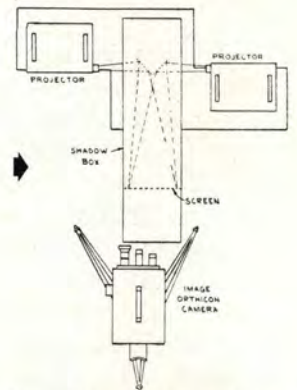

Above illustrates dual projectors into a single Image Orthicon camera by use of a simple light-tight shadow box 76" long. This provides a picture 11"x14" in size. Screen is set back in shadow box to prevent front lighting.

Iconoscope projection is illustrated below. With Iconoscope cameras the light path need not be enclosed. Picture is projected on image inverter and then reflected to the mosaic of the Iconoscope.

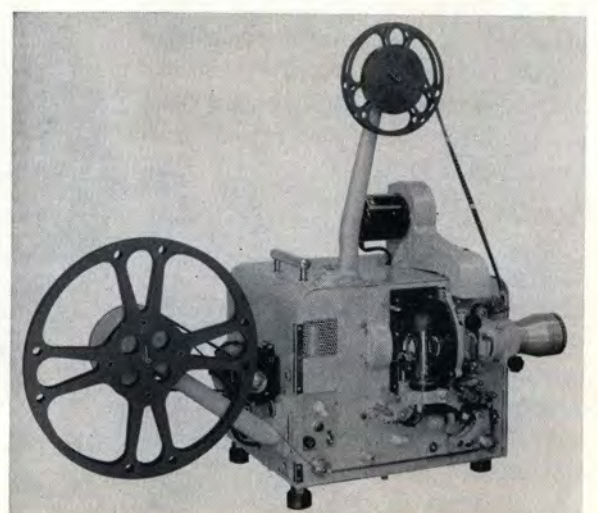
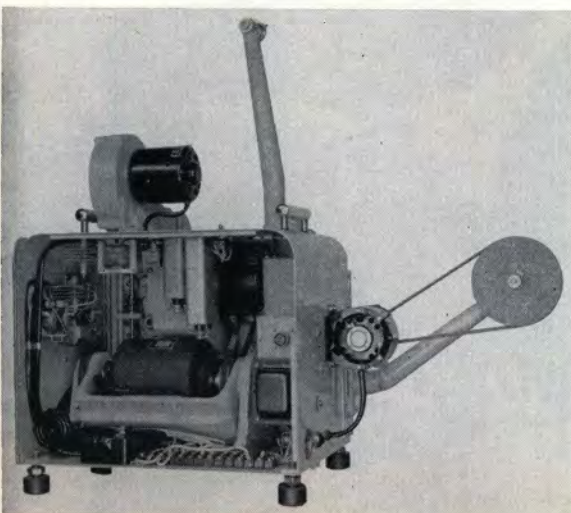
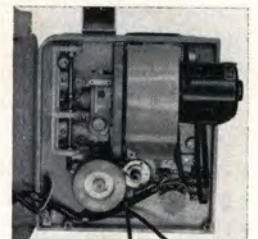
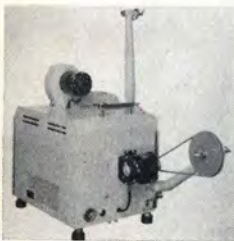
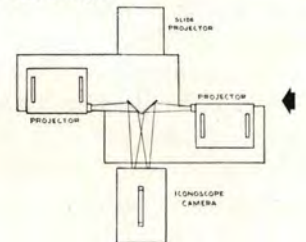

UHF Television Antenna—Channels 14-83

(By Workshop Associates)

A new, rugged, yet simple, and highly effective UHF transmitting antenna. Available in single or dual sections and at power gains of either 14 or 25. The line drawings at the bottom of this page, and the complete chart on the opposite page, give full details for mechanical computations.

Electrically, the antenna provides an essentially perfect circle of radiation. VSWR is rated at 1.1 or less. Horizontal pattern circularity is within $\pm 1/2$ db. Input impedance is 50 ohms to a single $3 1/8$ " UHF flanged coaxial cable.

Design is a self-supporting cantilever section, with adequate rigidity to maintain the deflection of the radiation center of the largest, or two-bay, antenna within $1/2^\circ$ for a 100 MPH wind velocity. Tubular steel construction is specified throughout. The main tubes, base mounting, top plates, and short circuiting blocks are welded together as a complete assembly. The self-supporting feeder assembly is assembled separately, and welded into place prior to hot dip galvanizing of the entire assembly. Means to drain off condensation are provided. A single gas seal is all that is required, and is provided at the base of the antenna. Antenna is weatherized, using windows of dielectric material, caulked and clamped over the slot faces. The exposed surfaces are mostly of smooth dielectric material which resists ice formations. In exceptional cases, de-icing equipment is available.

Top plate is designed to hold a 300 mm code beacon. Power inputs up to 50 kw may be handled safely. — The twin-bay unit (model WA25) is so designed that the feed point can be offset to provide optional beam tilt for particular requirements. All antennas are adjusted and tuned to frequency prior to shipment.

By consulting the table on the next page, full mechanical data is quickly obtainable. Type WA14 is single-bay, power gain of 14. Type WA25 is two-bay, power gain of 25. Height shown includes 300 mm beacon. Weight includes 300 mm beacon (allowance 70 lbs.). The number following the type number refers to the channel. Example WA14-20 would mean a single-bay, power gain 14, for channel 20.

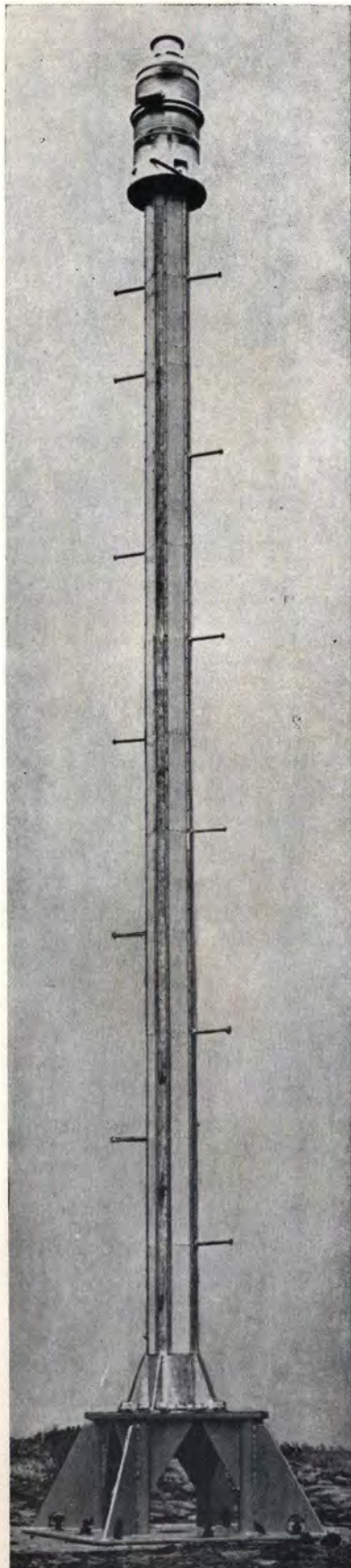

Single Bay WA14

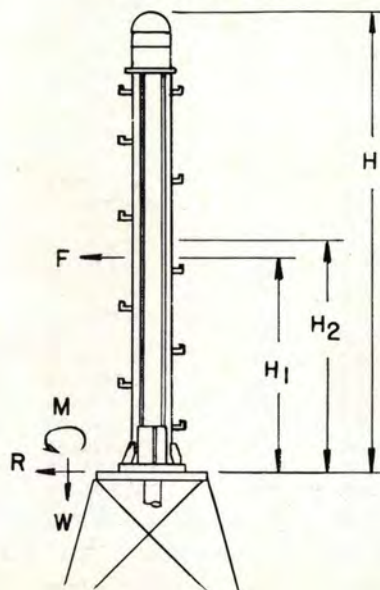

Double Bay WA25

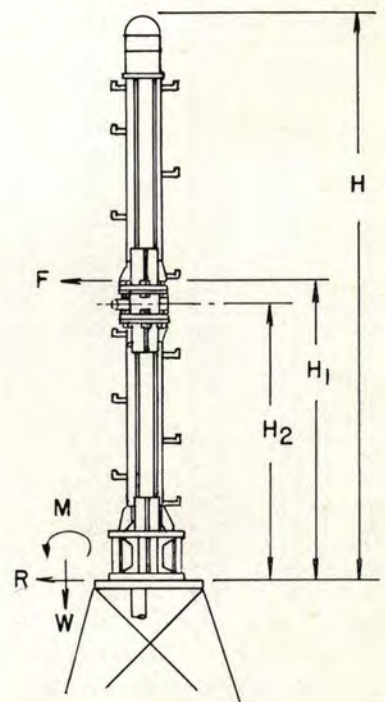

SPECIFICATIONS UHF ANTENNAS

(See reference drawings, preceding page)

Model WA14, Power Gain 14							Model WA25, Power Gain 25						
Model	H	H ₁	H ₂	M	R	W	Model	H	H ₁	H ₂	M	R	W
WA14-14	28.3	13.50	13.9	8200	608	1132	WA25-14	56.4	28.00	27.7	34700	1240	2820
WA14-15	28.0	13.35	13.7	8020	601	1120	WA25-15	55.7	27.70	27.3	33800	1220	2780
WA14-16	27.6	13.15	13.5	7780	592	1104	WA25-16	55.0	27.40	27.0	33000	1205	2750
WA14-17	27.4	13.05	13.4	7660	587	1096	WA25-17	54.5	27.05	26.7	32400	1194	2720
WA14-18	27.1	12.90	13.3	7490	581	1084	WA25-18	53.9	26.80	26.4	31700	1180	2700
WA14-19	26.8	12.75	13.1	7310	574	1072	WA25-19	53.4	26.50	26.1	31000	1170	2670
WA14-20	26.6	12.65	13.0	7200	569	1064	WA25-20	52.6	26.05	25.9	30000	1150	2630
WA14-21	26.2	12.45	12.8	6970	560	1048	WA25-21	52.3	25.90	25.6	29700	1145	2610
WA14-22	26.0	12.35	12.7	6860	556	1040	WA25-22	51.8	25.70	25.3	29200	1135	2590
WA14-23	25.8	12.25	12.6	6750	551	1032	WA25-23	51.3	25.50	25.1	28600	1122	2560
WA14-24	25.5	12.05	12.5	6590	546	1020	WA25-24	50.8	25.20	24.8	28000	1110	2540
WA14-25	25.3	12.00	12.4	6480	540	1010	WA25-25	50.3	25.00	24.6	27500	1100	2510
WA14-26	25.0	11.85	12.2	6310	533	1000	WA25-26	49.8	24.80	24.3	27000	1090	2490
WA14-27	24.8	11.75	12.1	6220	529	992	WA25-27	49.3	24.40	24.1	26400	1080	2460
WA14-28	24.6	11.65	12.0	6110	524	984	WA25-28	48.8	24.10	23.9	25800	1070	2440
WA14-29	24.3	11.50	11.9	5950	518	972	WA25-29	48.4	24.00	23.6	25400	1060	2420
WA14-30	24.1	11.35	11.8	5830	513	964	WA25-30	47.9	23.60	23.4	24800	1050	2390
WA14-31	23.9	11.25	11.7	5720	509	956	WA25-31	47.5	23.50	23.2	24400	1040	2370
WA14-32	23.7	11.15	11.6	5630	504	948	WA25-32	47.1	23.30	23.0	24000	1030	2350
WA14-33	23.5	11.10	11.5	5540	500	940	WA25-33	46.7	23.10	22.8	23600	1020	2330
WA14-34	23.3	11.00	11.4	5450	495	932	WA25-34	46.3	23.00	22.6	23200	1010	2310
WA14-35	23.1	10.90	11.3	5340	491	924	WA25-35	45.9	22.80	22.3	22800	1000	2290
WA14-36	22.9	10.80	11.2	5260	486	916	WA25-36	45.5	22.60	22.2	22400	990	2270
WA14-37	22.7	10.70	11.1	5150	482	908	WA25-37	45.1	22.30	22.0	22000	985	2250
WA14-38	22.5	10.65	11.0	5070	477	900	WA25-38	44.7	22.20	21.8	21600	975	2230
WA14-39	22.3	10.50	10.9	4960	473	892	WA25-39	44.4	22.10	21.6	21500	965	2220
WA14-40	22.1	10.40	10.8	4870	468	884	WA25-40	44.0	22.00	21.4	21100	957	2200
WA14-41	21.9	10.30	10.7	4770	464	876	WA25-41	43.6	21.60	21.2	20400	948	2180
WA14-42	21.8	10.20	10.6	4720	462	872	WA25-42	43.3	21.40	21.1	20200	943	2160
WA14-43	21.6	10.15	10.5	4640	457	864	WA25-43	42.9	21.30	20.9	19900	934	2140
WA14-44	21.4	10.05	10.4	4540	452	860	WA25-44	42.6	21.00	20.7	19430	926	2120
WA14-45	21.3	10.00	10.4	4500	450	856	WA25-45	42.3	20.90	20.6	19210	921	2110
WA14-46	21.1	9.90	10.3	4410	446	844	WA25-46	42.0	20.70	20.4	18900	914	2100
WA14-47	21.0	9.85	10.2	4370	443	840	WA25-47	41.6	20.60	20.3	18600	904	2080
WA14-48	20.8	9.75	10.1	4280	439	832	WA25-48	41.3	20.40	20.1	18300	898	2060
WA14-49	20.6	9.65	10.0	4190	434	824	WA25-49	41.0	20.20	19.9	18000	892	2050
WA14-50	20.5	9.60	10.0	4140	432	820	WA25-50	40.7	20.10	19.8	17800	885	2040
WA14-51	20.3	9.50	9.9	4060	427	812	WA25-51	40.4	19.85	19.6	17400	877	2020
WA14-52	20.2	9.45	9.8	4020	425	808	WA25-52	40.1	19.75	19.5	17200	870	2000
WA14-53	20.0	9.35	9.7	3940	421	800	WA25-53	39.7	19.55	19.4	16900	864	1990
WA14-54	19.9	9.30	9.7	3890	419	796	WA25-54	39.4	19.40	19.2	16600	855	1970
WA14-55	19.8	9.25	9.6	3860	416	792	WA25-55	39.3	19.35	19.1	16500	853	1965
WA14-56	19.6	9.15	9.5	3770	412	784	WA25-56	39.0	19.15	18.9	16200	846	1950
WA14-57	19.5	9.10	9.5	3730	410	780	WA25-57	38.8	19.00	18.8	16000	841	1940
WA14-58	19.4	9.05	9.4	3680	407	776	WA25-58	38.5	18.90	18.7	15800	835	1925
WA14-59	19.2	8.95	9.3	3600	403	768	WA25-59	38.2	18.80	18.5	15600	828	1910
WA14-60	19.1	8.90	9.3	3560	401	764	WA25-60	37.8	18.55	18.4	15200	820	1890
WA14-61	19.0	8.85	9.2	3520	398	760	WA25-61	37.7	18.50	18.3	15100	817	1885
WA14-62	18.9	8.80	9.2	3480	396	756	WA25-62	37.5	18.40	18.2	15000	815	1875
WA14-63	18.7	8.70	9.1	3410	392	748	WA25-63	37.2	18.30	18.1	14800	806	1860
WA14-64	18.6	8.65	9.0	3370	389	744	WA25-64	37.0	18.20	17.9	14600	800	1850
WA14-65	18.5	8.60	9.0	3330	387	740	WA25-65	36.8	18.10	17.8	14400	796	1840
WA14-66	18.4	8.55	8.9	3290	385	736	WA25-66	36.5	18.00	17.7	14200	790	1825
WA14-67	18.3	8.50	8.9	3250	383	732	WA25-67	36.3	17.80	17.6	14000	785	1815
WA14-68	18.2	8.45	8.8	3210	380	728	WA25-68	36.0	17.70	17.5	13800	780	1800
WA14-69	18.1	8.40	8.8	3180	378	724	WA25-69	35.8	17.60	17.4	13600	774	1790
WA14-70	17.9	8.30	8.7	3100	374	716	WA25-70	35.6	17.40	17.2	13400	770	1780
WA14-71	17.8	8.25	8.6	3060	371	712	WA25-71	35.4	17.35	17.1	13300	765	1770
WA14-72	17.7	8.20	8.6	3030	369	708	WA25-72	35.2	17.25	17.0	13100	760	1760
WA14-73	17.6	8.15	8.5	2990	367	704	WA25-73	35.0	17.20	16.9	13000	756	1750
WA14-74	17.5	8.10	8.5	2950	365	700	WA25-74	34.8	17.00	16.8	12800	752	1740
WA14-75	17.4	8.05	8.4	2910	362	696	WA25-75	34.4	16.85	16.7	12500	743	1720
WA14-76	17.3	8.00	8.4	2880	360	692	WA25-76	34.3	16.75	16.6	12400	740	1715
WA14-77	17.2	7.95	8.3	2840	358	688	WA25-77	34.2	16.70	16.5	12300	738	1710
WA14-78	17.1	7.90	8.3	2810	356	684	WA25-78	34.0	16.60	16.4	12200	734	1700
WA14-79	17.0	7.85	8.2	2770	353	680	WA25-79	33.8	16.50	16.3	12000	729	1690
WA14-80	16.9	7.80	8.2	2740	351	676	WA25-80	33.6	16.40	16.2	11900	725	1680
WA14-81	16.8	7.75	8.1	2700	349	672	WA25-81	33.4	16.35	16.1	11800	720	1670
WA14-82	16.7	7.70	8.1	2660	347	668	WA25-82	33.2	16.20	16.0	11600	716	1660
WA14-83	16.6	7.65	8.0	2630	344	664	WA25-83	33.1	16.10	15.9	11500	713	1655

Note: Tower drilling detail available on request. See drawings page 235 for legend.

H—height (ft.) H₁—mechanical center (ft.) H₂—electrical center (ft.) M—moment (ft./lbs.)
 R—shear (lbs.) W—weight (lbs.) F—total wind force (lbs.) equals R.

INDEX

Description	Page
Accessory cabinet, MO-3066	43
A. C. generators	188
Adapters, remote microphone	177
Air pressure control	197
Ampex precision power supply	169
Ampex speed lock	169
Ampex tape recorders	168, 169
Amplifiers	
Aircraft homing beacon transmitter	101
Amplifier power supplies	132, 153
Announco-mote	177
Cueing amplifiers	149
Fatigue	221
Intercommunication	187
Limiting amplifiers	148, 149
McIntosh	206
Monitoring amplifiers	131, 150, 152
Plug-in amplifiers	127-133
Preamplifiers	128, 129, 151
Presidential	194
Program amplifiers	130, 150, 152
Public address	180, 181, 206, 221
Recording (disc)	167
Recording (tape)	170, 172
Remote	see remote amplifiers
Selective amplifiers	117
Speech input consoles	see speech input consoles
Totalizing	221
Andrew coaxial cable	213-216
Antenna ammeters	62, 196
Antenna couplers	53, 59, 60, 61
Antenna isolation coils	56
Antenna meter shorting switches	197
Antenna meters, remote reading	62
Antenna tower chokes	56
Antenna tower lights	209
Antenna towers	207, 208
Antennas, dummy	206
Antennas (FM)	206
Arms, transcription	161, 206
Attenuator dials	194
Attenuator knobs	195, 219
Attenuators	194
Audio oscillator	50
Audio panel, transmitter	48
Audio terminal board	63
Audio transformers	190-193
Audition turntables	160
Auditory training unit	219
Auxiliary transmitter	33
Bass reflex speakers	182, 183
Beacon, 300 MM	210-212
Beacon transmitter	101
Binaural recorders	169, 171
Blank panels	154
Blowers	197
Boards, terminal	63
Boom stand, microphone	185
Bowls, feed-thru	218
Brackets, transmission line	217, 218
Branching equipment (phasors)	52
Bridging controls	132
Broadcast station layout	222
Broadcast transmitters, AM (540-1600 kc)	
250 watt, BC-250GY transmitter	26-30
250 watt, GY-48 radio station	31-32
250 watt, BCA-250 auxiliary transmitter	33-34
500 watt, BC-500GY transmitter	22-23
500 watt, GY-50 radio station	26
1000 watt, BC-1F transmitter	10-18
1000 watt, GY-1000 radio station	20-21
5000 watt, BC-5B transmitter	4-9
10,000 watt, BC-10B transmitter	4-9
20,000 watt, BC-20B transmitter	96-100
Unattended operation, remote control	178
Broadcast transmitters, FM	
10 watt educational BF-E-10 transmitter	37-38
250 watt, FMR-250 transmitter	35-36
Portable FM equipment	106

Description	Page
Broadcast transmitters (short wave)	
1000 watt, HF1-2 transmitter	73-78
5000 watt, HF-5B transmitter	66-72
10,000 watt, HF-10B transmitter	66-72
20,000 watt, HF-20B transmitter	96-100
Cabinets, disc	162
Cabinets, loudspeaker	182, 183
Cabinets, rack	63, 64, 197
Cable, microphone	185
Call letter plates	185
Cannon connectors	186
Capacitors, filter	204
Capacitors, mica	203
Capacitors, vacuum	202
Cathode ray oscilloscope	195
Center post insulator	217, 218
Centralized sound systems	221
Chokes, filter	190-193
Chokes, tower	56
Clocks	165
Coaxial cable	213-216
Coaxial speakers	182, 183
Coils, antenna isolation	56
Communications receivers	114, 115
Communications transmitters (FM)	
10 watt, 150 mc, BF-E-10 transmitter	99, 100
250 watt, FMR-250 transmitter	35, 36
3000/5000 watt, 200 mc, transmitter	105
FM Littlefone	106
Communications transmitters (short wave)	
250 watt, unit system	79-83
250 watt, CMG-1	84, 85, 86
500 watt, CMW-1	78, 79, 80, 81
1000 watt, police	91, 92, 93, 94
1000 watt, HF-1 series	73-78
5000 watt, HF-5 series	66-72
10,000 watt, HF-10 series	66-72
20,000 watt, HF-20 series	96-100
Two-way communications	106
Compressors, volume	148
Cone speakers	182, 183
Connectors, microphone	186
Consoles	see speech input consoles
Control console, transmitter	46
Control, master	146
Controls, bridging	132
Converter, frequency shift	109
Cordette, Magnecord	171
Cords, patch	145
Couplers, antenna	53, 59, 60, 61
Crystals and holders	112, 113
Cueing amplifier	149
Custom desks	162, 163
Daven attenuators	194
Demagnetizer, tape	172
Desk stands, microphone	185
Desks—Model CB-4 horseshoe	158
Model CB-60, CB-62, etc.	163
Sectionalized control desk	164
Dials	194
Diode type remote reading antenna meter	62
Directional phase monitors	57
Directional phasors	52-55
Disc cabinets	162
Disc recorders	160, 166
Disc recording amplifiers	167
Discs, blank recording	173
Distortion measuring equipment	50
Dual diversity receiver	116
Dummy antennas	206
Eicor tape recorders	173
Eimac tubes	199
End plates, open wire transmission line	217, 218
Entrance insulators	218
Equalizers, automatic (disc recording)	166
Equalizers, line	174
Equalizers, pickup	161
Equalizers, sound effects	175

INDEX

(continued)

Description	Page	Description	Page
Fan, rack cabinet ventilating	186	Monosets	186
Fatigue amplifiers	221	Noise and distortion meter	50
Federal tubes	198	Obstruction lights for towers	209-212, 219
Feed-thru bowls	218	Oil-filled capacitors	204
Ferrule resistors	205	Onan, A. C. generators	188
Filter capacitors	204	Open wire transmission line	217, 218
Filters, pickup	161	Oscillator, audio	50
Floor stands, microphone	185	Oscillator, variable master	110
FM antennas	206	Oscilloscope	195
Foreword	1	Ovens, crystal	112, 113
Four-hour tape recorder	171	Packaged radio stations	
Frequency and modulation monitor (FM)	111	250 watt	31
Frequency and shift monitor	108	500 watt	26
Frequency monitor (AM)	39-40	1000 watt	20
Frequency shift converter	109	Pads, fixed	194
Frequency shift keyer	107	Panels, blank	154
Gain set	50	Panels, patch	145
Gates, factories	3	Peak limiting amplifiers	148, 149
Gates, in pictures	220	Phase monitors	57
Gates, sales policy	2	Phase sampling loops	56
Generating plants, alternating current	188, 189	Phasors	52
Ground screen	219	Phones (headphones)	186
Ground wire	219	Pickup coil with rectifier	50
Hallicrafters Littlefone	106	Pickups, transcription	161, 206
Hallicrafters receivers	114-115	Plans	
Hammarlund receivers	114-115	Broadcast station	222
Headphones	186	CC1 console wiring plan	224
Hearing, auditory training unit	219	Floor plans	223
Homing beacon transmitter	101-104	Tape recorder wiring plan	225
Horn gap assembly	217	Plates, call letter	185
Housings, rack	154	Plug-in amplifiers	127
Houston, Texas Branch	25	Plug-in power supplies	132
Hughey & Phillips, tower lighting	209	Portable audition equipment	160
Indicators, volume	174	Portable remote amplifier	176, 177
Intercom equipment	187	Portable tape recorders	see tape recorders
Isolation chokes (tower light)	56	Portable transmitters	187
Isolation coils (antenna)	56	Power rheostats	205
Jacks, patch	145	Power supplies	132, 153, 169
Jennings, vacuum capacitors	202	Power supplies, A. C. generating	188
Keyer, frequency shift	107	Power terminal board	63
Keys, telegraph	186	Power transformers	190-193
Keys, telephone	195	Presidential amplifier	194
Klystrons	200	Pressure control, static	197
Knobs	195, 219	Presto amplifier, disc recording	167
Lamps, for tower lights	219	Presto recorders, disc	166
Library, tape	171	Presto tape recorders	172
Lights, studio warning	165	Presto turntables	159
Lights, tower	209	Projectors, television	233, 234
Limiting amplifiers	148, 149	Proof of performance package	49-51
Line equalizers	174	Public address systems	180-206
Littlefone, 2-way radio	106	Quincy, Illinois, picture of	220
Loops, phase sampling	56	Rack cabinets	63, 64, 197
Loudspeaker cabinets	182, 183	Rack cabinet ventilating fan	186
Loudspeakers, cone	182, 183	Rack housings	154
Magnecord tape recorders	170, 171	Radiators, vertical	207, 208
Master control	146, 147	Radio tubes	198
Master oscillator, variable	110	Receiver, selective amplifier	117
Mats, patch	145	Receivers, communications	114, 115
McIntosh amplifiers	206	Receivers, dual diversity	116
Meter shorting switches	197	Receptacles, microphone	186
Meters	197	Record cabinets	162
Meters, remote reading	62	Recorders, disc	160, 166
Mica capacitors	203	Recorders, tape	see tape recorders
Microphone cable	185	Recording amplifiers, disc	167
Microphone call letter plates	185	Recording discs	173
Microphones	184, 185	Recording equalizers, disc	166
Mobile transmitters	187	Recording supplies	173
Modulation monitor	41-42	Recording tape	173
Modulation transformers	192	Rectifier for RF (proof of performance)	50
Monitors		Reel adapter, Magnecord	171
Complete monitor accessory cabinet	43	Regulators, voltage	175
Frequency	39	Relay panel, plug-in	126
Frequency and modulation (FM)	111	Relays, solenoid	197
Frequency and shift	108		
Modulation	41		
Phase	57		

INDEX

(continued)

Description	Page	Description	Page
Remote amplifiers		Test set, volt ohmmeter	195
Adapter kits	177	Thermocouple antenna meters	62, 196
Announco-mote	177	Thermocouple type remote reading antenna meters	62
Dynamote, 3-channel	176	Three-channel remote amplifier	176
Presidential amplifier	194	Tools, burnishing	194
SA-134 amplifier	151	Totalizing amplifiers	221
SA-136 amplifier	177	Tower chokes	56
Remote control for unattended operation	178	Tower lights	209-212, 219
Remote meters for phasors	57	Tower termination equipment, 47A	61
Remote reading antenna meters	62	Towers, antenna	207, 208
Resistors	205	Transcription cabinets	162
Rheostats	205	Transcription turntables	
Rotary and lever switches	195	CB-4 desk with turntables	158
Sales policy	2	CB-11 chassis	157
Sampling loops	56	CB-14 transcription equipment	157
SA rack housings	154	CB-15 turntable	159
Screen, ground	219	Portable transcription unit	159
Sectionalized control desk	164	Presto Model 15G	159
Selective amplifier	117	Presto Model 64A	159
Shielded wire	185	Rek-O-Kut turntables	160
Short wave transmitters		Turntable pickups	161, 206
..... see communications transmitters		Turntable equalizers	161
Signal generator, audio frequency	50	Transformers	190-193
Sockets, transmitting tube	197	Transmitter accessory cabinet	43
Solenoid relays	197	Transmitter audio panel	48
Solid dielectric coaxial cable	216	Transmitter control console	46-47
Sound effects consoles	155	Transmitters, broadcast	see broadcast transmitters
Sound effects equalizers	175	Transmitters, communications see communications transmitters
Sound equipment	180	Transmitters, homing beacon	101-104
Sound systems, centralized	221	Transmitters, mobile portable	187
Southwestern office	25	Transmitters, television	
Speakers, loud	182, 183	500 watt VHF	228
Speech input consoles		5000 watt VHF	229
Accessories for CC1 console	125, 126	1000 watt UHF	231, 232
CC1 console	120-124	Transmitters, unattended operation equipment	178, 179
Master control	146, 147	Transmission line, coaxial	213-216
SA-40 console	141, 142	Transmission line, open wire	217, 218
SA-40 console on CB-4 desk	139	Tubes	198-202
SA-40 console on CB-63 desk	138	Tube sockets	197
SA-50 dual channel console	134, 137	Tuners, antenna	53, 59, 60, 61
52-CS studioette	142, 143, 144	Tuners, Hi-Fi	115
Speed lock, Ampex	169	Turntable preamplifier, SA-134	151
Spring-wound tape recorder	167	Twin-track recorders	see tape recorders
Stands, microphone	184, 185	Twinset headphones	186
Static pressure control	197	UHF television transmitters	231, 232
Stereophonic tape recorder	169	Unattended operation, remote control	178
Stethoscope type headphones	186	Vacuum capacitors	202
Studio clocks	165	Vacuum tube voltmeter	195
Switches, audio	195	Variable attenuators	194
Switches, meter shorting	197	Variable equalizers, disc	166
Taking proof of performance	51	Variable equalizers, line	174
Tape recorders		Variable equalizers, pickup	161
Ampex	168, 169	Variable equalizers, sound effects	175
Demagnetizer	172	Variable frequency oscillator	44-45
Eicor	173	Variable master oscillator	110
Magnecord	170, 171	Ventilating fan, rack cabinet	186
Reel adapter, 10½"	171	VHF television transmitters	228-230
TaPak, spring-wound	167	Voltage regulators	175
Tape, leader	173	Volt-amp wattmeter	195
Tape library	171	Voltmeter, vacuum tube	195
Tape, recording tape	173	Voltmeters	196
Tape, reels	173	Volt ohmmeters	195
Tapped resistors	205	Volume indicators	174
Telegraph keys	186	Voyager, Magnecord	171
Telephone keys	195	VU meters	196
Television, CC1 speech console	120	Wagons, sound effects	155
Television, projectors	233, 234	Waist-high rack cabinets	64
Television, sound effects console	155	Warning lights, studio	165
Television, UHF antenna	235, 236	Wattmeters	195
Temperature controlled ovens	112, 113	Wire, ground	219
Terminal boards	63	Wire, shielded studio	185
Test equipment (proof of performance)	49		

NOTICE—It has been the continuing policy of Gates to maintain each and every equipment manufactured to very highest standards of modern engineering design. Because of this, the Gates Radio Company reserves the right to modify any specification stated in this catalog where it is for the improvement of the equipment quality, either electrical or mechanical. Equipment sold by Gates, but not manufactured by Gates, is supplied with the same understanding.

QUICK INDEX OF COMPLETE EQUIPMENT

	Starting Page
Amplifiers, plug-in	127
Antenna couplers	59
A. C. generating plants	188
Coaxial cable	213
Consoles, speech input	120
Equalizers	174
Loudspeakers	182
Microphones and stands	184
Public address systems	180
Projectors	233
Rack cabinets	63
Remote equipment	176
Sound effects equipment	155
Towers	207
Tower lights	209
Transmitters, AM	4
Transmitters, FM	35
Transmitters, short wave	66
Transmitters, television	227
Tape recorders	167
UHF TV antenna	235
Unattended operation	178

See detailed index, preceding pages, for complete listing.

GATES RADIO COMPANY, QUINCY, ILLINOIS, U. S. A.

Manufacturing Engineers Since 1922

MAIN OFFICE* AND FACTORY

Quincy, Ill.
123 Hampshire St.

INTERNATIONAL OFFICE

New York City
13 E. 40th St.

CANADIAN SALES (Including Newfoundland)

Canadian Marconi Co.
Montreal, Que.

SOUTHWESTERN* OFFICE

Houston, Texas
2700 Polk Ave.

SOUTHEASTERN* OFFICE

Atlanta, Ga.
13th & Spring Sts.

NORTHEASTERN OFFICE

New York, N. Y.
51 East 42nd St.

WESTERN* OFFICE

Los Angeles, Calif.
7501 Sunset Blvd.

EASTERN ZONE OFFICE

Washington, D. C.
Warner Building

*Indicates stock carrying office.

Atlanta and Los Angeles offices opening
September 1, 1953.

Night and holiday engineering phone service at Quincy, Ill.
Cable address: GARCO, Quincy, Ill., or New York City.
Direct Western Union Printer service (WUX), Quincy, Ill.
Western Union Facsimile Service (FAX), Washington, D. C.

PRICE LIST — GATES MASTER CATALOG

PRICE LIST

GATES 240 PAGE MASTER CATALOG

GATES

Effective July 15, 1953

GATES RADIO COMPANY

MANUFACTURING ENGINEERS SINCE 1922

If You Didn't Get This From My Site, Then It Was Stolen From... QUINCY, ILLINOIS, U. S. A.

www.SteamPoweredRadio.Com

PRICE LIST — GATES MASTER CATALOG

(Effective July 15, 1953)

It is the purpose of this price list to provide the latest up-to-date selling prices on all equipment listed in the Gates 240 Page Master Catalog. So you may have a full understanding, it will be appreciated if you will note the following simple conditions pertaining to prices.

- 1—All prices are either F. O. B. Quincy, Illinois, or F. O. B. factory, unless otherwise stated. Where any item is prepaid, this means that prepayment is on the basis of railway freight or commercial truck carrier. If faster method of shipment is desired, then the freight charges will be allowed and the customer pays only the difference. In some instances, due to accounting procedures, and where any item is prepaid, the shipment may actually go forward transportation charges collect. In such an instance, and if the item is one that is to be prepaid, the equalized amount of these charges will be deducted from the invoice.
- 2—We are living in times of rapidly changing conditions, which means that prices are unstable. Some are up, others are down. Because of this, the prices herein are subject to change without notice. Where there has been any appreciable upward change in price, we will notify you before shipment. Where the price increase does not represent more than 5% of the total price shown in this list, shipment will go forward without request for permission from our customer, unless he specifically requests otherwise on the face of the order. In any event, the price applicable at time of shipment will supersede this price list.
- 3—Prices herein do not include export packing. They do include, however, proper packing charges for shipment within continental North America.
- 4—Where a later item replaces an item listed in this catalog, Gates will supply the later or newer item without requesting permission from the customer, provided the later or newer item is no higher in price, and does not deviate from specifications by reduction in quality.
- 5—Very little of the material listed in this catalog is subject to federal excise tax. Where this tax is applicable, it will be billed either separately or as part of the item itself. Sales or use tax, where applicable, will be billed in accordance with the regulations of each state in which the transaction is made. In those states where the collection of the "use" tax may be optional—collected from either the buyer or the seller—Gates delegates this option to the buyer.
- 6—All materials are shipped in approved shipping containers. Broken or damaged materials, regardless of the condition of the shipping container, should be immediately reported to the delivering carrier, who is finally responsible for any damage incurred during shipment.
- 7—Over-remittances with your order will be promptly refunded. Under-remittances, unless credit has been established, will automatically mean that you desire the balance to be shipped by sight draft or that payment will be made at time of delivery by the transportation company. Gates invites any customer who has not established credit with us to submit financial data to our credit department.
- 8—It is the sincere desire of the Gates Radio Company to provide fast shipment. Most items in this catalog and price list are carried in stock. Where they are not, the Gates purchasing department will use the Western Union leased wire service, or telephone, to see that the item is shipped on the same day your order is received, wherever possible. It is pointed out that our Emergency Shipping Service personnel do not have access to credit department files. Therefore, orders received after business hours, or on Sundays and holidays, may be shipped on a cash-on-delivery basis, even though the credit standing of the customer may be of the very best. This, we feel, is understandable to all of our customers.

GATES RADIO COMPANY, QUINCY, ILLINOIS.

PRICE LIST

(By Page Number)

Page	ITEM	PRICE	Page	ITEM	PRICE
8	BC-5B, 5000 watt transmitter with one set tubes, one crystal and oven	\$18,250.00	29	BC-250GYA, 250 watt transmitter with one set of tubes, one crystal and oven and for direct coupling to antenna	\$ 2,536.49
	Same as above for 50 cycle operation	18,500.00		Complete 100% set of tubes for BC-250GY or BC-250GYA transmitter	106.89
	BC-10B, 10,000 watt transmitter with one set tubes, one crystal and oven	22,000.00		JK57M crystal and oven to frequency, as ordered	50.00
	Same as above for 50 cycle operation	22,350.00	32	GY-48 packaged 250 watt radio station	4,144.49
	M-3701 complete 100% set of tubes for BC-5B transmitter	786.50		GY-48A packaged 250 watt radio station	4,074.49
	M-3825 complete 100% set of tubes for BC-10B transmitter	1,082.30	33	BCA-250, 250 watt auxiliary transmitter with one set of tubes	1,133.00
	PCH-1 protective covering for BC-5B transmitter power components	175.00		100% set of tubes for BCA-250 auxiliary transmitter, TK-157	38.00
	PCH-1 protective covering for BC-10B transmitter power components	250.00		JK57M crystal and oven to frequency, as ordered	50.00
	JK57M crystal and oven to frequency, as ordered	50.00		Note: Where BCA-250 transmitter is desired for 2 frequency operations such as standby and Conelrad—add \$50.00.	
17	1000 watt transmitter BC-1F/M-3250 with one set of tubes, one crystal and oven	5,950.00	36	FMR-250 transmitter with one set of tubes, crystal and oven to frequency, as ordered	2,475.00
	1000/500 watt transmitter BC-1F/M-3410 with one set of tubes, one crystal and oven	6,000.00		100% set of tubes for FMR-250 transmitter, M-4054	155.96
	JK57M crystal and oven to frequency, as ordered	50.00	38	BF-E-10 transmitter , one set of tubes, one crystal and oven	1,195.00
	Complete 100% set of tubes for BC-1F transmitter	305.25		BF-R-10 transmitter , one set of tubes, one crystal and oven	1,395.00
	CB-62 desk, less equipment	97.50		100% set of tubes for BF-E-10 or BF-R-10 transmitter	126.54
	Remote starting panel M-3409	35.00		FM-11 broad band antenna	37.50
21	GY-1000 packaged 1000 watt radio station	7,635.00	40	MO-2890 frequency monitor with tubes, to frequency as ordered	695.00
	GY-1000A packaged 1000 watt radio station	7,565.00		Complete 100% set of tubes for frequency monitor, M-2951	10.40
	Note: Add \$50.00 to either GY-1000 or GY-1000A if transmitter for 1000/500 watts.		42	MO-2639 modulation monitor with tubes	335.00
23	BC-500GY, 500 watt transmitter with one set of tubes, one crystal and oven	4,250.00		100% set of tubes for modulation monitor, M-2789	11.27
	BC-500AGY, 500 watt transmitter with one set of tubes, one crystal and oven	4,325.00	43	MO-3066 accessory cabinet , with tubes and to frequency as ordered	1,685.00
	JK57M crystal and oven to frequency, as ordered	50.00		MO-3066A accessory cabinet , with tubes and to frequency as ordered	1,615.00
	100% set of tubes for BC-500GY or BC-500AGY transmitter, TK-132	142.70	45	VFO/crystal oscillator and amplifier with tubes, less crystal	800.00
24	GY-50 packaged 500 watt radio station	5,935.00		JK57M crystal and oven to frequency, as ordered	50.00
	GY-50A packaged 500 watt radio station	5,865.00		100% tube kit for VFO	5.83
	Note: Add \$75.00 to either GY-50 or GY-50A where transmitter for direct coupling.		47	CCD-2 transmitter control console	750.00
29	BC-250GY, 250 watt transmitter with one set of tubes, one crystal and oven	2,461.49		CCD-2A transmitter control console	718.00
			48	SA-89 transmitter audio panel	495.00
				100% set of tubes for SA-89 unit, M-3179	6.85

Page	ITEM	PRICE	Page	ITEM	PRICE
49	SA-131 proof of performance package	\$ 458.50	64	CR-70 waist-high cabinet	\$ 52.00
51	MO-3625 gain set	115.00		CR-71 base for CR-70 cabinet	13.50
	Type 200 oscillator	138.00		TR-80 single linoleum top	19.00
	Type 400 noise and distortion meter	168.00		TR-81 double linoleum top	27.00
	MO-3626 rectifier and pickup coil	37.50		TR-82 triple linoleum top	39.00
	Extra plug-in pads for MO-3625 gain set, any impedance or loss	5.00		TR-83 quad linoleum top	51.00
53,54, 55	Phasing equipment	to order	71	HF-5B, 5000 watt transmitter	21,900.00
56	Sampling loop M-3283	95.00		HF-10B, 10,000 watt transmitter ..	25,200.00
	Sampling loop M-3389	95.00		HF-5BX, 5000 watt transmitter	22,300.00
	Sampling loop M-3723	35.00		HF-10BX, 10,000 watt transmitter ..	25,600.00
	Isolation coil M-3073	175.00		HF-5C, 5000 watt transmitter	19,250.00
	Isolation coil M-4561	140.00		HF-10C, 10,000 watt transmitter ..	21,500.00
	Tower choke M-3935	45.50		HF-5CX, 5000 watt transmitter	19,650.00
	Tower choke M-3936	65.00		HF-10CX, 10,000 watt transmitter ..	21,900.00
	Tower choke M-3937	85.75		HF-5TX, 5000 watt transmitter	15,485.00
	Tower choke M-3938	105.00		HF-10TX, 10,000 watt transmitter ..	15,985.00
58	Phase meter JI-108	550.00		HFXT-1 crystal and oven	55.00
	Phase meter JI-108A	575.00		HFTSB-5 100% tube complement for 5000 watt telephone models	789.00
	Phase meter JI-108B	600.00		HFTSB-10 100% tube complement for 10,000 watt telephone models....	1,063.30
	100% tube kit for JI-108 monitor ..	9.25		HFTSX-5 100% tube complement for 5000 watt telegraph models	535.00
59	Antenna coupling unit, Model 44..	230.00		HFTSX-10 100% tube complement for 10,000 watt telegraph models....	695.00
60	Antenna coupling unit, ACU-11 ..	575.00		HFK tube set for electronic keyer ..	7.00
	Antenna coupling unit, ACU-12 ..	875.00	78	HF1-2Y, 1000 watt transmitter	7,910.00
61	Tower termination equipment, Type 47A	585.00		HF1-3Y, 1000 watt transmitter	7,400.00
62	Remote meter M-3383	35.00		HF1-XY, 1000 watt transmitter	5,800.00
	Remote meter M-3133	35.00		JI-H17 crystal and holder	14.95
	Remote meter M-3386	35.00		JKO-2 oven for 2, JI-H17 holders ..	12.50
	Remote meter M-3931	35.00	80	Radio frequency unit M-3452Y	221.00
	Remote meter M-3384	40.50		Coil set M-3641	13.50
	Remote meter M-3385	40.50		Coil set M-3642	13.50
	Remote meter M-3387	40.50		Coil set M-3643	13.50
	Remote meter M-3932	40.50		Coil set M-3644	13.50
	Rack panel M-3955	6.50		Coil set M-3645	13.50
	Rack panel M-3956	6.50		M-3675 100% tube complement for M-3452Y R. F. unit	12.29
	Diode remote meter M-3294	49.50		Note: Catalog refers to coil set for 2-3 mc as M-3641 which is error. Correct number is M-3641.	
	Diode remote meter M-3294B	49.50		Modulator unit M-3453Y	350.00
	Diode remote meter M-3294D	49.50		M-3676Y 100% tube complement for modulator	13.60
	Diode remote meter M-3294A	55.00	81	Dual channel antenna coupler M-3451Y	160.00
	Diode remote meter M-3294C	55.00		Note: Above stated in catalog in error as M-3461Y.	
	Diode remote meter M-3294E	55.00		Single channel antenna coupler M-4239	80.00
63	Basic rack RAK-1	130.00	82	Main power supply M-3454Y	275.00
	SH1 shield	5.50		100% set of tubes for M-3454Y Power Supply, M-3677Y	6.15
	SH2 shield	6.25		Control panel M-3461Y	175.00
	SP1 side panel	16.00		Meter panel M-3460Y	47.00
	TRM1 single corner trim	10.00		Filament transformer AF-1994K ..	15.75
	TRM2 double trim	11.00		Note: Type number above corrected to AF-7994K.	
	BRK1 terminal board mounting bracket	3.40	83	M-3449Y two channel transmitter, one set of tubes, less crystals	1,700.88
	DMIX rack cabinet	89.00		Complete 100% set of tubes for M-3449Y transmitter	44.88
	TRM3 double trim	12.50			
	Terminal board No. 46	10.65			
	Terminal board CDM-12	2.74			

Page	ITEM	PRICE	Page	ITEM	PRICE
83	M-3491Y single channel transmitter, one set of tubes, less crystals	\$ 1,452.59	106	HT-21LDS Littlefone	\$ 324.95
	Complete 100% set of tubes for M-3491Y transmitter	32.59		HT-21LWS Littlefone	349.95
	M-3680Y single channel transmitter	1,281.59		HT-21HWS Littlefone	399.95
	Complete 100% set of tubes for M-3680Y transmitter	32.59		HT-22LDS Littlefone	324.95
	M-3629Y single channel telegraph transmitter	978.99		HT-22LWS Littlefone	349.95
	Complete 100% set of tubes for M-3629Y transmitter	18.99		HT-22HWS Littlefone	399.95
	H17 crystal and holder to frequency	14.95		HT-23 central station	485.00
	JK0-2 oven for 2 Type H17 holders	12.50		HT-24 central station	485.00
	M-4237 microphone assembly	35.00		S-82 receiver	49.50
				S-81 receiver	49.50
86	CMG-1, 250 watt transmitter	1,450.00		Note: Under certain conditions of sale, the above Hallcrafters Littlefone units are subject to Federal Excise Tax. This is applicable in about all cases except where tax is exempt such as Local, State and Federal purchases, etc. Federal Excise Tax is computed on 5% of the Littlefone prices listed above and will be billed as an additional amount over and above the above stated prices where tax is applicable.	
	100% set of tubes for above, TK-136	39.25	107	Frequency shift keyer 105-4	790.00
	Microphone assembly M-4576	36.00		100% tube complement for above, TK-141	14.20
	Filter LPF-52	22.50	108	Frequency and shift monitor 106-4	895.00
	Filter LPF-72	22.50		100% tube complement for above, TK-142	11.85
	Filter LPF-250	22.50	109	Frequency shift converter 107-2	705.00
90	CMW-1, 500 watt transmitter	2,955.00		100% tube complement for above, TK-145	28.67
	100% set of tubes for above, TK-137	123.06	110	Variable master oscillator 115-1	980.00
	Microphone assembly, M-4576	36.00		100% tube complement for above, TK-144	11.80
	Coil set FDK-2A	35.18	111	Communications Frequency-Modulation monitor, JK-FD-12:	
	Coil set FDK-2B	29.19		For single frequency operation	425.00
	Coil set FDK-2C	27.88		For two frequency operation	465.00
	Coil set FDK-2D	13.50		For three frequency operation	505.00
	Coil set FDK-2E	12.50		For four frequency operation	545.00
	Coil set FDK-2F	12.50		Desk cabinet DL-128	12.00
	Coil set FDK-2G	12.90		100% tube complement, TK-147	15.76
94	CMP-1, 1000 watt transmitter	3,785.00		Below, when ordering crystals and ovens, please specify frequency in kilocycles.	
	CMP-1A, 1000 watt transmitter	3,785.00	112	H-4 crystal and holder	14.95
	CMP-1B, 1000 watt transmitter	3,785.00		H-17 crystal and holder:	
	CMP-1D, 1000 watt transmitter on application			200-500 kc	14.95
	CON-2 remote control panel	116.50		500-1000 kc	24.95
	100% set of tubes, TK-138	166.90		1000-50,000 kc	14.95
				50,000-100,000 kc	19.95
100	HF-20B transmitter	} on application		H-17L crystal and holder:	
	HF-20BX transmitter			200-500 kc	14.95
	BC-20B transmitter			5000-35,000 kc	14.95
	HF-20TX transmitter			H-17W crystal and holder:	
	TK-139 tube set			200-500 kc	14.95
	TK-140 tube set		5000-35,000 kc	24.95	
104	Homing beacon transmitter M-3975	5,825.00		35,000-100,000 kc	24.95
	Antenna coupler M-4116	295.00		H-17T crystal and holder:	
	M-4033 remote control unit	see below		15-20 kc	29.95
	Note: M-4033 remote unit is part of M-3975 transmitter and included in selling price of \$5,825.00.			20-100 kc	24.95
	M-4124 microphone assembly	35.00		100-200 kc	14.95
	JK0-2 oven with crystal to frequency	50.00		H-22 stabilized crystal and holder:	
				50-80 kc	29.50
105	200 mc 5000 watt transmitter on special order			80-150 kc	24.95

Page	ITEM	PRICE	Page	ITEM	PRICE
112	JK57M crystal and oven	\$ 50.00	125	Four channel mixer, Type MX-1.	\$ 177.00
	JK57MT crystal and oven	56.00		Single switching unit, Type SSW-1	177.00
	JK87M crystal and oven	50.00		Double switching unit, Type	
	JK87MT crystal and oven	56.00		DSW-1	199.00
113	JK-02 stabilized heat less crystals:		126	Sound effects unit, Type CSE-2	536.00
	6 volt heater	12.50		CB-6300 desk	137.95
	12 volt heater	14.50	128	Preamplifier, Type PRE4	59.75
	JK-02T stabilized heat less crystals:			Tube set for PRE4, Type TK-112.	3.50
	6 volt heater	18.00		Base and receptacle for PRE4,	
	12 volt heater	24.50		Type BA20	5.25
	JK-07 oven only	39.50		Preamplifier, Type PRE1	79.00
	JK-07E oven only	49.50		Tube set for PRE1, Type TK-100.	5.25
	Note: Crystals for above quoted on request. State frequency and tolerance desired.			Base and receptacle for PRE1,	
	JK-G9 stabilized unit:			Type BA20	5.25
	3 kc— 10 kc	99.50	129	Preamplifier, Type PRE3	58.75
	10 kc— 20 kc	69.50		Tube set for PRE3, Type TK112	3.50
	20 kc— 60 kc	59.50		Base and receptacle for PRE3,	
	60 kc— 90 kc	49.50		Type BA20	5.25
	90 kc—200 kc	29.95		Base and receptacle, small size	5.25
	180 kc—300 kc (GT)	59.50		Base and receptacle, large size	5.50
	JK-G9J stabilized unit:			Panel and shelf unit, PAS1	22.50
	1.2 kc—2.5 kc	270.00		Panel and shelf unit, PAS1A	24.50
	2.5 kc—4.0 kc	231.00	130	Program amplifier, Type PGM4	87.75
	4.0 kc—6.6 kc	195.00		Tube set for PGM4, Type TK122 ..	5.35
	6.6 kc— 10 kc	150.00		Base and receptacle for PGM4,	
	Frequency Standard:			Type BA21	5.50
	FS-344 standard	79.50		Program amplifier, Type PGM1 ..	115.00
	FS-344A temperature controlled			Program amplifier, Type PGM1A.	137.00
	frequency standard	149.50		Tube set for either PGM1 or	
114	Receiver, Model S40B	119.95		PGM1A, Type TK101	6.55
	Receiver, Model S40BO	special order		Base and receptacle for PGM1 or	
	Receiver, Model S76	179.50		PGM1A, Type BA21	5.50
	Receiver, Model SX71	224.50	131	Monitoring amplifier, Type MON4	92.85
	Loudspeaker, Model R46	19.95		Tube set for MON4, Type TK121	6.70
	Receiver, Model SX73	975.00		Base and receptacle for MON4,	
115	High fidelity tuner, Model ST-83.	129.95		Type BA21	5.50
	Hi-Fi amplifier, Model A-84	99.50		Monitoring amplifier, Type MON1	124.50
	SP-600JX receiver	1,075.00		Tube set for MON1, Type TK102	9.46
	CAB14 cabinet for SP-600JX	15.00		Base and receptacle for MON1,	
116	Dual diversity receiver	on application		Type BA21	5.50
	M-3737 modulation monitor	95.00	132	Power supply, Type PWR3	62.00
	M-3738 modulation monitor	95.50		Tube set for PWR3, Type TK103	6.70
117	Selective amplifier M-3922	220.00		Bias supply unit for PWR3,	
	100% tube complement for above	5.41		Type PWR4	9.25
124	Basic CC1 console with tubes	1,496.75		Base and receptacle for PWR3,	
	PRE4 preamplifier with tubes	63.25		Type BA21	5.50
	PGM4 program amplifier with			Preamplifier power supply,	
	tubes	93.10		Type PWR5	37.00
	CB-6300 desk	137.95		Tube set for PWR5, Type TK104.	.75
	Typical CC1 console combinations:			Base and receptacle for PWR5,	
	CC1 console with 5 preamplifiers			Type BA20	5.25
	and tubes	1,813.00		Bridging control AT1	6.50
	CC1 console with 10 preamplifiers			Bridging control AT2	6.50
	and tubes	2,129.25		Bridging control AT3	6.50
	CC1 console with 10 preamplifiers			Bridging control AT4	6.50
	and 2 program amplifiers, with			Bridging control AT5	6.50
	tubes	2,222.35			
	Note: Add \$137.95 to any of above if CB-6300 desk is desired.				

Page	ITEM	PRICE	Page	ITEM	PRICE
137	Complete console, Model SA-50 ...	\$ 1,650.00	153	Power supply, SA-77	\$ 25.00
	100% tube complement for SA-50			Power supply, SA-99	62.00
	console, TK149	27.60		Power supply, SA-101	42.50
	SA-50 console with CB-60 desk			Power supply, SA-78	27.00
	and cable, Type SA-5060	1,754.50		Power supply, SA-79	31.50
141	Complete console, Model SA-40 ...	1,295.00		Power supply, M-3229	90.00
	100% tube complement for SA-40,			100% tube complement for SA-77,	
	Type TK118	25.17		SA-99, SA-78 or SA-79, Type	
	Desk, Type CB-63	87.50		TK133	1.32
	SA-40 console complete with CB-60			100% tube complement for SA-101	
	desk and cable, Type SA-4060	1,399.50		or M-3229, Type TK134	1.50
144	Console, Model 52-CS	695.00		Power supply, SA-7	85.00
	100% tube set for 52-CS,			100% tube complement for SA-7,	
	Type TK106	18.24		Type TK154	1.50
145	C-150 single row jack strip	29.00		Power supply, SA-102	80.00
	C-1500 double row jack strip	46.00	154	Housing, Model SA-400	16.95
	PD1 jack mat	7.25		Housing, Model SA-500	17.50
	PD2 jack mat	7.25		Housing, Model SA-600	18.00
	PD3 jack mat	7.25		Housing, Model SA-700	18.50
	PJ12 patch cord	7.80		Housing, Model SA-800	19.00
	PJ13 patch cord	7.98	156	Sound effects console, CSE-9	4,995.00
	PJ14 patch cord	8.28		Loudspeaker and mobile dolly,	
	PJ15 patch cord	8.52		LSB-2	358.00
147	Local pre-set unit, M-4219	630.00		100% tube complement for CSE-9,	
	Master pre-set unit, M-4218	640.00		Type TK155	66.40
148	Limiting amplifier, SA-38	395.00	157	Turntable CB-14A	382.00
	100% tube complement for SA-38,			Turntable CB-14B	479.00
	Type TK150	16.34		Turntable CB-14M	391.00
149	Limiting amplifier, SA-39	335.00		Turntable CB-14N	490.00
	100% tube complement for SA-39,			Turntable chassis CB-11	165.00
	Type TK150	16.34	158	Horseshoe desk, CB-4	350.00
	SA-22 cueing amplifier	110.00		Desk with turntables, CB-4A	999.00
	100% tube complement for SA-22,			Desk with turntables and pre-	
	Type TK151	4.70		amplifiers, CB-4B	1,151.00
150	Program amplifier, SA-20	179.00		Note: Models CB-4A and CB-4B are com-	
	100% tube complement for SA-20,			pletely wired, ready for use, includ-	
	Type TK107	5.30		ing all necessary cutouts, switches,	
	Monitoring amplifier, SA-10	199.00		fuse blocks, etc.	
	100% tube complement for SA-10,		159	Turntable, Model CB-15	559.00
	Type TK152	8.12		100% tube complement for CB-15,	
151	Preamplifier, SA-70	57.75		Type TK156	8.83
	Preamplifier, SA-71	62.00		Portable turntable, CB-16	360.00
	Preamplifier, SA-72	66.50		Portable turntable, CB-16A	435.00
	100% tube complement for SA-70,			100% tube complement for CB-16A,	
	SA-71, SA-72, Type TK105	1.98		Type TK107	3.68
	Amplifier, Model SA-134	75.00		Presto Model 15-G turntable	53.50
	100% tube complement for SA-134,			Presto Model 64-A turntable	420.75
	Type TK107	3.68	160	3-speed transcription chassis,	
152	Program amplifier, SA-94	105.00		B16H	250.00
	100% tube complement for SA-94,			Variable speed turntable, LP-743	59.50
	Type TK108	3.76		Recording turntable, TR12H	129.95
	Monitoring amplifier, SA-95	100.00		Overhead mechanism, M12-108 ...	99.95
	100% tube complement for SA-95,			Overhead mechanism, M12-120 ...	99.95
	Type TK117	5.41		Overhead mechanism, M12-192 ...	99.95
	Monitoring amplifier, SA-96	85.00		Note: Above overhead mechanisms include	
	100% tube complement for SA-96,			lead screw. For extra lead screws	
	Type TK153	4.40		to any pitch, order 108, 120 or 192	
				lines. State whether inside-out or	
				outside-in. Price each, \$17.95.	

Page	ITEM	PRICE	Page	ITEM	PRICE
160	Recording turntable, Model V	\$ 215.00	164	Electrical shield, AHT-12	\$ 3.50
	Overhead mechanism, MS-105	215.00		Angular trim piece, 22½ degree, AHT-13	5.00
	Overhead mechanism, MS-120	215.00		Angular trim piece, 45 degree, AHT-14	7.50
	Overhead mechanism, MS-210	215.00			
	Note: Above overhead mechanisms include lead screw. Price is \$37.50 for 105 and 120 lines and \$47.50 for 210 lines. State whether inside-out or outside-in.		165	Warning light, AM-1	14.95
	Deluxe auditioning equipment, 12-VP2	122.50		Warning light, AM-2	14.95
	Transcription player, 6-U	67.95		Warning light, AM-3	14.95
	Audition unit, 10-P2	89.50		Warning light, AM-4	15.50
	Needle force gauge, 301	1.50		Warning light, AM-5	16.25
				Warning light, AM-6	17.00
161	Gray 106-SP arm	45.15		Warning light, AM-7	17.00
	Gray 108-B arm	56.00		Clock No. 438-W	13.95
	Gray 602 equalizer	49.50		Clock No. 12-B	13.95
	RPX047 dual stylus cartridge, less styli	9.27	166	Presto 66-G recorder	846.60
	RPX046 cartridge, less stylus	6.87		Additional for microgroove	59.50
	Sapphire stylus, RPJ-001, RPJ-005, RPJ-006	2.10		Presto 6-N recorder	624.75
	Diamond stylus, RPJ-002, RPJ-003, RPJ-004	16.50		Additional for microgroove	59.50
	Sapphire stylus, RPJ-007, RPJ-010	3.57		Presto K-10 recorder	348.00
	Diamond stylus, RPJ-011, RPJ-012	29.97		Presto 160-A equalizer	218.45
	Chip chaser CH-1 for 16" discs	3.75		Presto 160-B equalizer	340.00
	Chip chaser CH-1 for 12" discs	3.00		Presto 161-A slider unit	89.25
	Tape splicer Edit-11	6.50	167	Presto 90-B recording amplifier....	505.75
	Presto 1-D-16 cutting head	159.80		Presto 92-B recording amplifier....	333.75
	Presto 1-D-500 cutting head	159.80		Spring wound tape recorder, TPK-7	309.95
162	Discabinet A-7	22.50	168	Ampex Model 300C-560C recorder	1,735.00
	Discabinet B-10	24.75		Ampex Model 300C-3389 recorder..	1,735.00
	Discabinet C-12	34.65		Bridging meter control panel 515-2	125.00
	Discabinet D-16	46.75		Model 300-S deluxe portable recorder 4408-S	1,875.00
	Sectional tape cabinet No. 1021	9.90		Model 300-S deluxe portable recorder 4409-S	1,875.00
	Reel storage cabinet No. 5384	96.00		Model 300-S deluxe portable recorder 4424-S	1,875.00
	Reel storage cabinet No. 7288	90.00		Model 300-S deluxe portable recorder 4423-S	1,875.00
	Sectional tape cabinet No. 542	11.50		Model 400 console tape recorder 3672	995.00
	Sectional tape cabinet No. 742	13.50		Model 400 console tape recorder 3672-1	995.00
163	Desk, Model CB-60	135.00		Model 400 console tape recorder 3675	995.00
	Joiner cable, CP-95	39.50		Model 400 console tape recorder 3675-1	995.00
	Joiner cable, CP-94	39.50		Remote control unit 3766	60.00
	Desk, Model CB-60A	108.00	169	Model 400 portable No. 1048	985.00
	Desk, Model CB-62	97.50		Model 400 portable No. 3377	985.00
	Desk, Model CB-62A	85.00		Model 400 portable No. 1996	985.00
	Desk, Model CB-63	87.50		Model 400 portable No. 3379	985.00
164	Sectionalized control desk:			Model 402 portable No. 3677	1,045.00
	Basic control desk, M-4356	177.50		Model 402 portable No. 3677-1	1,045.00
	Left end bell, M-4437	60.00		Four channel mixer No. 3761	250.00
	Right end bell, M-4438	60.00		Speed lock No. 2535-1	on application
	Standard shelf support, M-4439....	22.50		Speed lock No. 2535-2	on application
	Angle shelf support, M-4440	22.50		Precision power supply No. 841	600.00
	Right shelf end bell, M-4441	15.00		Stereophonic recorder 4043	1,575.00
	Left shelf end bell, M-4442	15.00		Stereophonic recorder 4043-1	1,575.00
	Standard metal shelf, M-4443	10.00			
	Standard Formica shelf, M-4444 ..	25.00			
	Angle shelf, M-4445 (metal)	10.00			
	Angle shelf, M-4446 (Formica)	25.00			
	Fill piece and back cover, M-4447	30.00			

Page	ITEM	PRICE	Page	ITEM	PRICE	
170	Magnecord Model PT63-AH	\$ 365.00	173	Minnesota Mining Recording Tape and Accessories:		
	Magnecord Model PT63-A2H	395.00		Cat. No.	Price less than 12	
	Plug-in equalizer 91-S-133	21.00		HU-6-111A	\$13.33	
	Note: Where above units desired for half track, add \$20.40. Deduct \$20.00 if carrying case not desired.			RE-6-111A	17.33	
	Record and playback amplifier, PT63-J	395.00		111-AP-1200	4.00	
	Record and playback amplifier, PT63-JX	375.00		41-100½27	
	Magnecord Model PT6-AH	330.00		41-100¾32	
	Magnecord Model PT6-A2H	351.00		43-15040	
	Plug-in equalizer for ¾ in. sec. No. 91-S-133	21.00		RE-3P17	
	Note: Where above units desired for half track, add \$14.85. Deduct \$20.00 if carrying case not desired.			RE-4P37	
	Tape recording amplifier, PT6-J	260.00		RE-5P44	
	Tape recording amplifier, PT6-JX	240.00		RE-7P50	
171	Magnecord Voyager, PT6-VAH	499.50		RE-7M50	
	Magnecordette No. PT6-AHX6C ..	425.00		RE-10½M	3.00	
	Magnecordette No. PT6-BAHX6C ..	425.00		RE-14M	5.80	
	4-hour tape player No. 4-14	585.00		HU-850	
	8-hour tape player No. 8-14	615.00				
	10½-inch reel adaptor No. 93X4....	39.00		Audio Discs and Styli:		
	Binaural recording amplifier PT6-BN	515.00		Red Label	less than 25	
	Binaural recorder and playback PT6-BAH	390.00		R8-D	\$.54	
172	Presto amplifier No. 900-A2	403.00		R10-D75	
	Complete recorder and amplifier RC7-900-A2	828.00		R12-D	1.23	
	Mechanism Type RC-7	425.00		R16-D	2.25	
	Amplifier A-920	324.00		R12-S99	
	Complete recorder RC7-A920	749.00		R16-S	1.77	
	RC-11 mechanism	775.00		Yellow Label		
	RC-11P mechanism in portable case	827.00		Y-8D45	
	RC-11CM console cabinet	925.00		Y-10D60	
173	Minnesota Mining Recording Tape and Accessories:			Y-12D99	
	Cat. No.	Price less than 12		Y-16D	1.77	
	120A-600	\$ 2.67		Reference Label		
	120A-1200	4.34		RE-10D51	
	120A-1200P	special order		RE-12D75	
	HU-1-120A	8.00		RE-16D	1.35	
	RE-1-120A	9.90		Blue Label		
	HU-2-120A	16.00		B-6½D24	
	RE-2-120A	20.00		B-8D33	
				B-10D48	
	101A-15050		Masters		
	101A-300	1.00		M-12D	1.56	
	101A-600	1.50		M-13¼D	2.01	
	101A-1200P	2.34		M-17¼D	3.36	
	101A-1200M	2.34		M-12S	1.23	
	HU-3-101A	4.34		M-13¼S	1.41	
	RE-3-101A	6.24		M-17¼S	2.46	
	HU-4-101A	8.67		Recording Styli		
	RE-4-101A	12.67		SY-1	3.63	
				SY-1L	3.63	
	111A-15067		SY-2	3.63	
	111A-300	1.17		SY-2L	3.63	
	111A-600	2.34		Eicor tape recorder, 230-S	114.40	
	111A-1200P	3.67		Eicor tape recorder, 230-D	110.47	
	111A-1200M	3.67				
	HU-5-111A	6.67		174	VU range set, V-22	108.25
	RE-5-111A	8.57			Terminal board kit TER-37	5.00
					Fixed equalizer LE-1	15.25
					Variable equalizer LE-2	80.25
					SA-116 line equalizer	56.40
					SA-117 line equalizer	60.40
					SA-118 line equalizer	58.40
					SA-119 line equalizer	44.40
					SA-120 line equalizer	40.40
					SA-121 panel for four equalizers	10.00
					SA-122 panel for five equalizers	10.00

Page	ITEM	PRICE	Page	ITEM	PRICE
175	Sound effects equalizer FSE-1	\$ 145.00	182	Baronet enclosure, EV-AR8B	\$ 41.40
	Sound effects equalizer FSE-2	145.00		Baronet enclosure, EV-AR8M	39.00
	Voltage regulator No. 3954-1	534.00		Stephens co-spiral speaker, 102-FR	70.50
	Voltage regulator No. 3954-2	590.00		Stephens co-spiral speaker, 5102-FR	76.50
	Voltage regulator No. 3954-3	770.00		Tru Sonic silver cabinet, 525-12	59.25
	Voltage regulator No. 3954-4	1,522.00		Tru Sonic silver cabinet, 525-15	59.25
	Voltage regulator No. 3954-5	2,317.00		Surface mount ceiling baffle, BL-6A	7.80
176	Dynamote, Model CB-65	325.00		Surface mount ceiling baffle, BL-8A	13.20
	Microphone plug XL3-1290		Surface mount ceiling baffle, BL-10A	16.20
	100% tube kit for Dynamote, M-3811	7.08		Surface mount ceiling baffle, BL-12A	16.20
	Spare set of batteries for Dyna- mote, DY-B-1	11.10		Flush mount ceiling baffle, AL-6A	4.50
177	SA-134 single channel remote amplifier	75.00		Flush mount ceiling baffle, AL-8A	7.30
	ANO-134 Announco-mote	135.00		Flush mount ceiling baffle, AL-10A	9.18
	SA-136 two-microphone remote amplifier	125.00		Back cover assembly, XCP-6	3.60
	100% tube kit for SA-134, ANO-134 or SA-136—No. M-3691	3.68		Back cover assembly, XCP-8	4.50
	Microphone plug XL3-1290		Back cover assembly, XCP-1012	6.00
	Microphone adaptor cable, M-3782	2.50			
	Microphone adaptor cable, M-3781	4.82			
	Microphone adaptor cable, M-3780	3.54			
179	RCM-12 remote control system for unattended operation	2,335.00			
	RCM-14 remote control system for unattended operation	2,195.00			
	Note: Prices of above vary slightly, depending on type of transmitting equipment, etc. Prices stated are maximum prices. Installation may be anywhere in the United States for \$300.00 flat fee, subject to change without notice.				
180	Stromberg-Carlson amplifier, AU-29	42.00		Steel plaster ring, PR-6	1.20
	Cover, Type AC-29	4.20		Steel plaster ring, PR-8	1.59
	Stromberg-Carlson amplifier, AU-42	60.00		Steel plaster ring, PR-12	3.00
	Stromberg-Carlson amplifier, AU-34	70.50		Flush mount wall baffle, RS-6A	3.00
	Stromberg-Carlson amplifier, AU-36	114.00		Flush mount wall baffle, RS-8A	3.33
	Stromberg-Carlson amplifier, AP-50	108.00		Flush mount wall baffle, RS-10A	4.56
	Cover, Type AC-50	4.50		Flush mount wall baffle, RS-12A	4.56
181	25-watt 2-speaker portable, PS-33	149.10		Wall cabinet, M6	3.30
	15-watt 2-speaker portable, PS-32	109.80		Wall cabinet, M8	4.15
	Stromberg-Carlson amplifier, AU-32	64.80		Wall cabinet, M12	7.50
	Stromberg-Carlson amplifier, AU-33	89.10	183	Jensen speaker, P-4X	3.10
	Stromberg-Carlson amplifier, AU-35	147.00		Jensen speaker, P-6X	3.42
182	Radax 12" speaker, SP-12	57.00		Jensen speaker, P-8T	6.90
	Radax 12" extended range speaker, SP-12B	29.70		Jensen speaker, P-10T	7.65
	Aristocrat enclosure, EV-AR12B	72.00		Jensen speaker, P-10Q	17.40
	Aristocrat enclosure, EV-AR12M	66.00		Jensen speaker, P-12T	8.70
	Radax 8" coaxial speaker, SP-8B	28.50		Jensen speaker, P-12Q	19.74
	Stephens coaxial speaker, 5106-AX	134.25		Jensen speaker, P-15Q	26.55
				Speaker matching transformer, Z-3300	1.08
				Speaker matching transformer, ZL-2021	1.55
				Speaker matching transformer, ZY-4004	3.60
				Speaker matching transformer, ZY-2002	3.60
				Speaker matching transformer, ZY-2003	5.18
				Speaker matching transformer, Z-3423	6.24
				Utility cabinet, B-121	32.65
				Bass reflex cabinet, C81-ST864	25.00
				Bass reflex cabinet, C81-ST865	25.00

Page	ITEM	PRICE
183	Bass reflex cabinet, C121-ST866 ..\$	33.16
	Bass reflex cabinet, C121-ST867 ..	33.16
	Bass reflex cabinet, C151-ST868 ..	41.33
	Bass reflex cabinet, C151-ST869 ..	41.33
	Imperial cabinet, D121-ST156	51.67
	Imperial cabinet, D121-ST157	51.67
	Triaxial speaker, G610-ST900	229.50
	Transformer for triaxial speaker, T202	12.36
	Coaxial speaker, K510	92.70
	Coaxial speaker, K410	71.70
	Coaxial speaker, K310	39.30
	Coaxial speaker, K210	23.70
	Control network, A110-ST832	18.90
	Impedance transformer, T102	7.95
	Impedance transformer, T103	7.95
	Type M reproducer cabinet, M-ST-838	109.50
	Type M reproducer cabinet, M-ST-858	109.50
	X stretcher leg assembly, ST-843	10.50
	X stretcher leg assembly, ST-863	10.50
	High frequency control, ST-606	1.80
	Coaxial level control, ST-783	5.25
	Range control switch, ST-784	5.25
184	Telefunken microphone, U47M and U47N power supply	390.00
	Note: Power supply and microphone sold together only.	
	Microphone, American DR-332	51.00
	Desk stand, Type ND	6.00
	Microphone, Shure 556-S	60.00
	Microphone, Shure 300	75.00
	Microphone, Shure 315	45.00
	Microphone, American D-33	75.00
	Desk stand, Type ND	6.00
	Microphone, velocity V2A	39.00
	Microphone, velocity V1A	27.60
	Microphone, Altec 660A	45.00
	Microphone, Altec 660B	49.50
	Lavalier microphone, No. 647	48.00
	Microphone, No. 635	42.00
	Microphone, slim trim, No. 655.....	120.00
	Microphone, slim trim, No. 654.....	57.00
185	Studio floor stand, MS-25	12.90
	Collapsible floor stand, CS-1	9.60
	Sky hook, SK-1	2.10
	Boom stand, BS-36	36.00
	Bracket clamp, BC-1	2.10
	Snap-on microphone attachment, SO-1	1.65
	Banquet stand, TS-6	5.40
	Desk stand, DS-7	3.00
	Rear exit desk stand, DS-10	3.00
	Duplex microphone-copy stand, TB-1	6.00
	Shielded audio wire, SH2-20	per M 50.00
	Shielded audio wire, No. 1261	per M 55.00
	Microphone cable, MIC-100	per C 8.00

Page	ITEM	PRICE
185	A-125 call letter plate	\$ 7.50
	A-118A call letter plate	9.00
	A-110 call letter plate	10.50
	A-105 call letter plate	3.50
	A-115 call letter plate	8.50
	A-118 call letter plate	9.00
	A-127 call letter plate	11.00
	A-117 call letter plate	8.50
	A-116 call letter plate	8.50
186	Cannon Connectors:	
	P3-14	1.68
	P3-CG-11S	3.78
	P3-CG-12S	3.10
	P3-13	3.21
	P3-35	5.49
	P3-35-2G	11.13
	P3-36	4.26
	P3-36-2G	8.79
	XL-3-1472
	XL-3-1193
	XL-3-1393
	XL-3-1290
	XL-3-35	2.64
	XL-3-36	2.67
	XL-3-35-2G	5.61
	XL-3-36-2G	5.59
	Hubbell Connectors:	
	7557	1.43
	757284
	7559	1.43
	Amphenol Connectors:	
	91-PG3F33
	91-MC3M66
	91-MC3F66
	Headphones, Type A	7.20
	Headphones, Type A-1	10.80
	Monoset, Type 2841	11.13
	Monoset, Type 2842	11.13
	Monoset, Type 3725	10.35
	Monoset, Type 3735	10.35
	Standard semi-automatic key, 114-501	19.20
	Standard semi-automatic key, 114-501L	21.00
	Heavy duty key, 114-321	5.10
	Rack cabinet ventilating fan, RAK-F-1	16.50
187	Two-station intercom system, LC-2	30.60
	3 conductor cable, 5303	per ft. .03
	Master station, LM-5	27.00
	Master station, LM-10	34.80
	Sub-station, LR-3	8.57
	3 conductor cable, 5303	per ft. .03
	Note: Where earphone is added to models LC-2, LM-5 or LM-10, add \$12.00.	
	Redi-power master station, C5912	96.00
	Redi-power master station, C59520	107.40
	Note: Cradle phone hand set may be included with models C5912 or C5920, add \$27.00.	
	Staff station, C41	13.20
	Staff station, C41M	13.20

Page	ITEM	PRICE
187	Weatherproof re-entrant horn, C20	\$ 26.98
	Cable for connecting master stations, 6204	per ft. .06
	RP-10 mobile transmitter with hand microphone	450.00
	RP-10A mobile transmitter, less microphone	435.00

188	Generating Plants	
	1000 watts, Model 10LS (115 volts)	461.00
	1000 watts, Model 10L (115 volts)	384.00
	1000 watts, Model 10LS (230 volts)	461.00
	1000 watts, Model 10L (230 volts)	384.00
	3500 watts, Model 305CK-1R	625.00
	3500 watts, Model 305CK-1P	615.00
	3500 watts, Model 305CK-1M	550.00
	3500 watts, Model 305CK-2R	625.00
	3500 watts, Model 305CK-2P	615.00
	3500 watts, Model 305CK-2M	550.00
	3500 watts, Model 305CK-3R	670.00
	3500 watts, Model 305CK-3P	665.00
	3500 watts, Model 305CK-3M	590.00
	5000 watts, Model 5CW-3M	850.00
	5000 watts, Model 5CW-3R	895.00
	5000 watts, Model 5CW-4M	850.00
	5000 watts, Model 5CW-4R	895.00
	5000 watts, Model 5CW-5M	850.00
	5000 watts, Model 5CW-5R	895.00

Models 5CW-7M and 5CW-7R special order

	10,000 watts, Model 10CW-3M	1,130.00
	10,000 watts, Model 10CW-3R	1,175.00
	10,000 watts, Model 10CW-4M	1,130.00
	10,000 watts, Model 10CW-4R	1,175.00
	10,000 watts, Model 10CW-5M	1,130.00
	10,000 watts, Model 10CW-5R	1,175.00
	10,000 watts, Model 10CW-6M	1,130.00
	10,000 watts, Model 10CW-6R	1,175.00

Models 10CW-7M and 10CW-7R ... special order

189	15,000 watts, Model 15HK-3R	2,415.00
	15,000 watts, Model 15HK-4R	2,470.00
	15,000 watts, Model 15HK-5R	1,810.00
	15,000 watts, Model 15HK-7R	special order
	14,000 watts, Model 14HK-53R	2,415.00
	14,000 watts, Model 14HK-54R	2,470.00
	14,000 watts, Model 14HK-55R	1,810.00
	14,000 watts, Model 14HK-57R	special order
	25,000 watts, Model 25HN-3R	2,745.00
	25,000 watts, Model 25HN-4R	2,800.00
	25,000 watts, Model 25HN-5R	2,800.00
	25,000 watts, Model 25HN-7R	special order
	20,000 watts, Model 20HN-53R	2,745.00
	20,000 watts, Model 20HN-54R	2,800.00
	20,000 watts, Model 20HN-55R	2,800.00
	20,000 watts, Model 20HN-57R	special order
	35,000 watts, Model 35JT-3R	3,625.00
	35,000 watts, Model 35JT-4R	3,680.00
	35,000 watts, Model 35JT-5R	3,680.00

Note: Models 35JT-6R and 35JT-7R—special order.

189	30,000 watts, Model 30JT-53R	\$ 3,625.00
	30,000 watts, Model 30JT-54R	3,680.00
	30,000 watts, Model 30JT-55R	3,680.00

Note: Models 30JT-56R and 30JT-57R—special order.

189 Automatic Line Transfer Panels:

Cat. No.	Voltage	Cycle	Phase	Wire	Amps.	Price
AF10-1	115	60	1	2	10	\$ 85.00
AF60-1					60	145.00
AF100-1					100	265.00
AF200-1					200	465.00
AF30-2	230	60	1	2	30	145.00
AF60-2					60	265.00
AF100-2					100	365.00
AF200-2					200	675.00
AF30-3	115 or 230	60	1	3	30	145.00
AF60-3					60	265.00
AF100-3					100	365.00
AF200-3					200	675.00
AF30-4	120 or 208	60	3	4	30	165.00
AF60-4					60	265.00
AF100-4					100	365.00
AF200-4					200	675.00
AF30-5	230	60	3	3	30	165.00
AF60-5					60	265.00
AF100-5					100	365.00
AF200-5					200	675.00

190 Input Transformers:

AI-3001U transformer	16.74
AI-3002U transformer	23.05
AI-3006T transformer	10.50
AI-3009T transformer	14.80
AI-3011T transformer	14.70
AI-7638T transformer	21.95
AI-7639T transformer	22.00
AI-7683T transformer	24.40
AI-7715T transformer	10.35
AI-7716T transformer	10.20
AI-8357U transformer	9.90
HS-1 transformer	23.10

Modulation Transformers:

AM-3161C transformer	286.20
AM-3167M transformer	2,142.00
AM-7718C transformer	1,638.00
BM-1 transformer	40.20
M-3X transformer	3.75
AM3205M transformer	502.60
AM3204M transformer	397.45

191 Output Transformers:

AO-3033U transformer	17.55
AO-3037U transformer	14.14
AO-3039T transformer	7.15
AO-3040 transformer	14.90
AO-3045T transformer	23.00
AO-7244T transformer	14.50
AO-7640T transformer	13.25
AO-7717T transformer	11.45

Page	ITEM	PRICE	Page	ITEM	PRICE
191	AO-8459C transformer.....	\$ 7.75	193	AP-7430C transformer.....	\$ 27.72
	AO-8549C transformer.....	225.00		AP-7431C transformer.....	22.59
	AO-8554T transformer.....	12.20		AP-8000M transformer.....	648.00
	CG-710 transformer.....	9.35		AP-8093T transformer.....	13.66
	BO-1 transformer.....	21.45		P-2520 transformer.....	79.20
	PSO-150 transformer.....	8.79		R-11A transformer.....	5.55
				7P91 transformer.....	855.36
192	Special Transformers:			AS-8766M transformer.....	375.00
	AS-3154U transformer.....	11.32		Reactors:	
	AS-3155U transformer.....	21.00		AC-3121U reactor.....	4.50
	AS-3157U transformer.....	28.80		AC-3122U reactor.....	6.78
	AS-3158C transformer.....	20.25		AC-3135C reactor.....	230.00
	AS-3172C transformer.....	57.42		AC-3136C reactor.....	169.50
	AS-3174C transformer.....	36.45		AC-3137C reactor.....	14.35
	HS-66 transformer.....	16.50		AC-3138C reactor.....	12.15
	LPF-1 transformer.....	8.13		AC-3140C reactor.....	53.75
	Z-3342 transformer.....	8.40		AC-3141C reactor.....	72.00
	ZL-2021 transformer.....	1.86		AC-3143C reactor.....	93.60
	ZY-2002 transformer.....	2.16		AC-3146C reactor.....	56.88
	ZY-2003 transformer.....	6.18		AC-3147C reactor.....	187.20
	ZY-4004 transformer.....	4.32		AC-3168C reactor.....	1,769.40
	114A transformer.....	19.50		AC-3170C reactor.....	1,170.00
	114B transformer.....	20.50		AC-7427 reactor.....	54.00
	114C transformer.....	20.46		AC-7719C reactor.....	1,386.00
	Filament Transformers:			BR-1 reactor.....	75.90
	AF-3091 transformer.....	10.00		C-12X reactor.....	2.16
	AF-3097 transformer.....	7.45		R-18 reactor.....	1.80
	AF-3098 transformer.....	8.30	194	Attenuators:	
	AF-3120C transformer.....	19.71		LA-350-K.....	8.65
	AF-3176C transformer.....	15.21		LA-350-EF.....	8.65
	AF-3180C transformer.....	50.85		LA-350-F.....	8.65
	AF-7234C transformer.....	14.45		LA-350-G.....	8.65
	AF-7236C transformer.....	28.17		LAQ-350-EF.....	8.65
	AF-7237C transformer.....	19.65		LAQ-350-G.....	10.00
	AF-7238C transformer.....	9.32		Spec. 2574-EF.....	12.50
	AF-7240C transformer.....	54.72		LA-730-EF.....	16.00
	AF-7241C transformer.....	51.30		LA-730-F.....	16.00
	AF-7242C transformer.....	19.98		T-257-G.....	18.00
	AF-7428C transformer.....	28.26		T-330-G.....	20.15
	AF-7429C transformer.....	28.26		BAL-330-G.....	27.50
	AF-7432C transformer.....	11.15		TA-1000-4.....	25.00
	AF-7433C transformer.....	40.39		A-4311-101.....	6.00
	AF-7434C transformer.....	20.34		Lever Type Attenuators:	
	AF-7435C transformer.....	27.65		LA-821-K.....	20.50
	AF-7782C transformer.....	53.46		LA-821-G.....	20.50
193	AF-7994K transformer.....	17.10		T-831-K.....	32.50
	AF-8003C transformer.....	22.25		T-831-G.....	32.50
	AF-8334C transformer.....	32.73		Tapped Fixed Networks:	
	AF-8345C transformer.....	55.35		1030-K.....	7.00
	F-14X transformer.....	1.62		1030-G.....	7.00
	Power Transformers:			1230-K.....	11.00
	AP-3061U transformer.....	14.40		1230-G.....	11.00
	AP-3062U transformer.....	19.33		Single Input—Multiple Output Pads:	
	AP-3065U transformer.....	14.87		1130-1.....	5.50
	AP-3078 transformer.....	8.85		1130-2.....	5.50
	AP-3090M transformer.....	1,161.00		1130-8.....	5.50
	AP-7235C transformer.....	125.10		1130-9.....	5.50
	AP-7239C transformer.....	31.86			

Page	ITEM	PRICE
194	Potentiometers:	
	A-3404-4	\$.75
	A-3404-3	1.15
	CP-354X	8.65
	A-5544-2	2.70
	Fixed Pads:	
	PH-46	2.50
	PH-420	2.50
	PH-16	2.50
	PH-120	2.50
	PH-212	2.50
	PT-46	2.50
	PT-420	2.50
	PT-16	2.50
	PT-120	2.50
	PT-212	2.50
	Presidential amplifier, Type PRE-34	775.00
	Tools and Supplies:	
	TM-151
	TM-5	3.36
	No. 3245
	TM-2	3.36
	Davenoil attenuator lubricant25
	Plug burnishing paste65
	Dial plates (all styles)60
195	Mirroscope, Model 476	179.50
	Volt-Ohm-Milliammeter, Model 240	26.35
	Vacuum Tube Voltmeter, Model 303	58.75
	Vacuum Tube Voltmeter, Model 303RT	66.70
	Volt-Ohm-Milliammeter, Model 260	38.95
	Volt-Ohm-Milliammeter, Model 260RT	46.90
	Volt-Amp-Wattmeter, Model 390 ..	39.50
	Keys—Mountings:	
	170D	4.09
	173N	5.83
	173P	8.94
	55	1.00
	Rotary and Lever Switches:	
	1316-L	1.50
	B-11139-390
	B-11139-2	1.30
	1325-L	2.10
	1346-L	5.45
	1335-L	3.00
	N-1007650
	N-1007880
	N-973575
	Knobs and Handles:	
	S-489-64L-BB45
	483-64-4040

Page	ITEM	PRICE
195	2921-L	\$.10
	4901-H (red)10
	4901-H (black)10
	5149-A (red)10
	5149-A (black)10
	5149-A (ivory)10
	4926 (red)10
	4926 (black)10
196	Weston 3" radio frequency ammeter, 425	17.85
	Weston 3" radio frequency ammeter, 425EX	24.25
	Weston 3" radio frequency ammeter, 425ET	24.85
	Westinghouse 3" radio frequency ammeter, RT-35	14.45
	Westinghouse 3" radio frequency ammeter, RT-35EX	18.70
	Westinghouse 3" radio frequency ammeter, RT-35ET	22.95
	Weston 4" radio frequency ammeter, 743	33.15
	Weston 4" radio frequency ammeter, 743EX	40.80
	Weston 4" radio frequency ammeter, 743ET	38.25
	Westinghouse 4" radio frequency ammeter, RT-37	16.58
	Westinghouse 4" radio frequency ammeter, RT-37EX	20.83
	Westinghouse 4" radio frequency ammeter, RT-37ET	26.35
	Weston 4" illuminated VU meter, 862	46.62
	Weston 3" VU meter, 301	34.45
	Burlington 4" VU meter, 745	22.00
	Burlington 3" VU meter, 535	20.00
	A. C. Voltmeters, 3" case:	
	Weston 476	
	0-1.5 to 0-50	12.10
	0-100	12.75
	0-150	13.40
	0-250	13.80
	0-300	15.30
	0-500	17.85
	Westinghouse RA-35	
	0-1.5 to 0-80	10.20
	0-100	11.05
	0-150	11.50
	0-200	11.90
	0-300	17.00
	Burlington 532	
	0-1.5 to 0-100	7.80
	0-150	8.55
	0-300	10.20
	0-500	12.60
	D. C. Milliammeters, 3" case:	
	Weston 301	12.15
	Westinghouse RX-35	9.35
	Burlington 531	7.80

Page	ITEM	PRICE
196	D. C. Voltmeters, 3" case:	
	Weston 301	\$ 12.75
	Westinghouse RX-35	10.20
	Burlington 531	9.00
	D. C. Milliammeters, 4" case:	
	Weston 741	25.50
	Westinghouse RX-37	11.50
	Burlington 741	8.85
	A. C. Voltmeters, 4" case:	
	Weston 744	
	0-10 to 0-75	25.50
	0-100	26.15
	0-130	26.80
	0-150	26.80
	0-250 to 0-300	33.80
	Westinghouse RA-37	
	0-10 to 0-80	12.35
	0-100	13.20
	0-130	13.20
	0-150	13.60
	0-250	13.60
	0-300	19.15
	Burlington 742B	
	0-10 to 0-100	8.85
	0-150	9.60
	0-250 to 0-300	11.25
	D. C. Voltmeters, 4" case:	
	Weston 741	25.50
	Westinghouse RX-37	14.50
	Burlington 741B	10.20
	Meter Multipliers for D. C. Voltmeters:	
	MFB-155	23.40
	MFB-205	27.70
	MFB-255	31.90
	MFB-305	36.15
	MFA-505	53.15
	MFA-605	61.65
197	Meter shorting switch, MO-3823....	55.00
	Meter shorting switch, MO-3863....	20.00
	Note: Above type number should read MO-2863.	
	Solenoid relay, MO-3480A	60.00
	Solenoid relay, MO-3480B	60.00
	Tube socket, MO-3934	35.00
	Tube socket, MO-3933	39.50
	Power tube blower, BC-25	295.85
	Meter base with shorting bar, MO-3280	3.75
	Meter mounting plug, MO-3281	6.00
	Pressure switch, 104A	32.57
	Pressure switch, 104B	32.57
	Pressure switch, 104C	32.57
	Pressure switch, 104D	32.57
	Pressure switch, 104E	32.57

Page	ITEM	PRICE
198	Tubes:	
	F-123-A	\$ 17.15
	F-127-A	55.20
	F-204-A	115.00
	F-212-E	104.00
	F-849	138.00
	F-450TH	60.00
	F-128-A	184.00
	F-132-A	230.00
	F-7C26	272.00
	F-7C23	173.00
	F-5680, Pulse	214.00
	F-5680, R. F. Amplifier	214.00
	F-7C25	154.00
	F-3X2500	198.00
	F-891-R	385.00
	F-892-R	385.00
	F-129-R	431.00
	F-889-RA	285.00
	F-5667	302.50
	F-8C25	576.00
	F-124-R	1,357.00
	F-9C31	1,460.00
	F-9C29	1,505.00
	F-893-AR	1,150.00
	F-8002-R	1,300.00
	F-872-A	8.20
	F-315-A	38.60
	F-575-A	21.00
	F-869-B	132.00
	F-857-B	209.00
	F-266-B	209.00
	F-873	12.00
	F-5563	40.00
	F-222-A	300.00
	802	4.75
	803	24.25
	805	17.50
	806	34.25
	807	2.50
	810	16.25
	811A	5.00
	812A	5.00
	813	18.00
	814	14.25
	828	13.75
	833A	49.50
	838	13.75
	845	13.75
	849	138.00
	866A	2.10
	872A	8.20
	885	2.00
	889R	210.00
	891R	385.00
	892R	385.00
	8008	8.20
	673	21.00

Page	ITEM	PRICE	Page	ITEM	PRICE
199	2C39A	\$ 34.00	202	Vacuum Capacitors:	
	3W5000A3	198.00		VC6-20	\$ 15.00
	3W5000F3	198.00		VC6-32	17.25
	3W10000A3	957.00		VC12-20	16.50
	3X2500A3	198.00		VC12-32	20.00
	3X2500F3	198.00		VC25-20	20.00
	3X3000A1	198.00		VC25-32	23.25
	3X3000F1	198.00		VC50-20	24.25
	6C21	77.00		VC50-32	27.50
	25T	9.00		VVC60-20	60.00
	35T	10.50		VVC2-60-20	147.50
	35TG	10.50		VVC4-60-20	284.00
	75TH	13.25			
	75TL	13.25		Jennings Vacuum Capacitors:	
	100TH	18.25		VCC6, 20KV	11.44
	100TL	18.25		VCC6, 30KV	12.60
200	4-65A	20.00		VCC12, 20KV	13.99
	4-125A	30.25		VCC12, 30KV	15.50
	4-250A	41.25		VCC25, 20KV	16.52
	4-400A	60.25		VCC25, 30KV	18.17
	4-1000A	132.00		VCC50, 20KV	19.07
	4PR60A	90.00		VCC50, 30KV	20.97
	4W20000A	1,850.00		VCC75, 20KV	28.04
	4X150A	48.00		VCC75, 30KV	30.08
	4X150D	48.00		VCC100, 20KV	30.49
	4X150G	54.00		VCC100, 30KV	33.54
	4X500A	121.00		VCC150, 20KV	42.90
	4X500F	121.00		VCC150, 30KV	47.19
	4E27A/5-125B	35.75		VCC200, 20KV	52.63
201	152TH	28.75		VCC200, 30KV	57.89
	152TL	28.75		VCC250, 20KV	62.37
	250TH	33.00		VCC250, 30KV	68.61
	250TL	33.00		VC6, 20KV	11.44
	304TH	60.50		VC6, 30KV	12.60
	304TL	60.50		VC12, 20KV	13.99
	450TH	77.00		VC12, 30KV	15.50
	450TL	77.00		VC25, 20KV	16.52
	592/3-200A3	30.25		VC25, 30KV	18.17
	750TL	137.50		VC50, 20KV	19.07
	1000T	137.50		VC50, 30KV	20.97
	1500T	220.00		VC75, 20KV	28.04
	2000T	275.00		VC75, 30KV	30.08
	3K20000LA	2,975.00		VC100, 20KV	30.49
	3K20000LF	2,975.00		VC100, 30KV	33.54
	3K20000LK	2,975.00		VC150, 20KV	42.90
202	2-01C	15.25		VC150, 30KV	47.19
	2-25A	11.00		VC200, 20KV	52.63
	2-50A	13.75		VC200, 30KV	57.89
	2-150D	19.25		VC250, 20KV	62.37
	2-240A	66.00		VC250, 30KV	68.61
	2-2000A	214.50		MC500, 10KV	123.33
	250R	22.00		MC500, 15 & 20KV	135.66
	253	20.50		MC750, 10KV	142.06
	8020/100R	15.00		MC750, 15 & 20KV	156.27
	KY21A	13.25		MC1000, 10KV	158.56
	RX21A	9.00		MC1000, 15 & 20KV	174.42
	866A	1.95		M500, 10KV	94.86
	872A	8.20		M500, 15 & 20KV	104.35
				M750, 10KV	109.27
				M750, 15 & 20KV	120.20

Page	ITEM	PRICE	Page	ITEM	PRICE
202	M1000, 10KV	\$ 121.97	203	F2-5325	\$ 10.38
	M1000, 15 & 20KV	134.17		F2-533	10.38
	AT10-50, 20KV	70.81		F2-534	10.38
	AT10-50, over 20KV	77.89		F2-535	10.38
	AT15-75, 20KV	70.81		F2-536	10.38
	AT15-75, over 20KV	77.89		F2-5375	10.38
	UCS10-375, 7½KV	127.05		F2-538	10.38
	UCS10-375, over 7½KV	139.76		F2-521	10.38
	UCS25-500, 7½KV	147.00		F2-5215	10.38
	UCS25-500, over 7½KV	161.70		F2-522	10.38
	UHC10-75, 35KV	183.68		F2-5225	10.38
	UHC10-75, over 39KV	202.05		F2-523	10.38
	UH10-75, 35KV	107.34		F2-424	10.38
	UH10-75, over 35KV	118.07		F2-325	10.38
	UXC25-500, 10KV	223.23		F2-326	10.38
	UXC25-500, over 10KV	245.55		F2-328	10.38
	UX25-500, 10KV	107.34		F2-211	10.38
	UX25-500, over 10KV	118.07		F2-2115	10.38
	VMMC50-1000, 10KV	308.00		F2-212	10.38
	VMMC50-1000, over 10KV	338.00		F2-213	10.38
	VMMC100-2000, 10KV	439.60		F2-1514	10.38
	VMMC100-2000, over 10KV	483.56		F2-1515	10.38
	VMM100-2000, 10KV	357.00		F2-0501	11.52
	VMM100-2000, over 10KV	392.70		F2-0202	15.15
	VMMHC25-450, 35KV	439.60		F2-02025	16.74
	VMMHC25-450, over 35KV	483.56			
	VMMH25-450, 35KV	357.00		Type F3 Mica Capacitors:	
	VMMH25-450, over 35KV	392.70		F3-8325	21.15
203	Type F1 Mica Capacitors:			F3-835	21.15
	F1-341	7.56		F3-821	23.55
	F1-345	7.56		F3-822	23.55
	F1-331	7.56		F3-825	29.16
	F1-3315	7.56		F3-811	33.12
	F1-332	7.56		F3-415	37.11
	F1-3325	7.56		F3-201	29.16
	F1-333	7.56		F3-06025	26.76
	F1-334	7.56		F3-0605	31.53
	F1-335	7.56		F3-0610	49.11
	F1-336	7.56			
	F1-3375	7.56		Type E Mica Capacitors:	
	F1-338	7.56		E-1245	6.60
	F1-321	7.56		E-1231	6.60
	F1-3215	7.56		E-12325	6.60
	F1-322	7.56		E-1235	6.60
	F1-3225	7.56		E-1221	6.60
	F1-223	7.56		E-12215	7.83
	F1-224	7.56		E-1222	9.00
	F1-225	7.56		E-1023	10.83
	F1-226	7.56		E-1024	11.43
	F1-1528	7.56		E-1025	12.03
	F1-111	7.56		E-721	6.03
	F1-112	8.58		E-722	7.83
	F1-0215	8.58		E-723	8.43
	F1-0201	9.06		E-711	12.63
	Type F2 Mica Capacitors:			E-3524	8.43
	F2-545	10.38		E-3525	7.83
	F2-531	10.38		E-3511	12.03
	F2-5315	10.38		E-3512	12.03
	F2-532	10.38		E-3515	13.83
				E-215	12.03
				E-201	13.83

Page	ITEM	PRICE
203	Type G1 Mica Capacitors:	
	G1-641	\$ 21.27
	G1-645	22.92
	G1-631	24.36
	G1-632	24.36
	G1-634	26.61
	G1-635	27.99
	G1-621	27.99
	G1-6215	29.34
	G1-622	29.34
	G1-623	30.36
	G1-624	30.36
	G1-625	30.36
	G1-526	30.87
	G1-511	30.87
	G1-4115	30.87
	G1-312	30.87
	Type G2 Mica Capacitors:	
	G2-1031	39.33
	G2-10315	39.33
	G2-1032	39.33
	G2-10325	39.33
	G2-1035	39.33
	G2-1021	39.33
	G2-10212	39.33
	G2-10215	39.33
	G2-1022	39.33
	G2-823	39.33
	G2-824	39.33
	G2-525	39.33
	G2-526	41.49
	G2-511	41.49
	G2-4115	41.49
	G2-312	41.49
	Type G3 Mica Capacitors:	
	G3-2045	66.54
	G3-2031	72.60
	G3-2032	78.66
	G3-20325	78.66
	G3-2033	78.66
	G3-2035	82.29
	G3-2038	82.29
	G3-2021	84.69
	G3-15215	85.92
	G3-1522	85.92
	G3-1523	90.75
	G3-1524	90.75
	G3-1025	90.75
	G3-1026	90.75
	G3-1028	90.75
	G3-1011	90.75
	G3-512	90.75
	G3-313	90.75
	Type G4 Mica Capacitors:	
	G4-3043	100.74
	G4-3045	100.74
	G4-3031	126.18
	G4-30315	126.18
	G4-30325	132.69

Page	ITEM	PRICE
203	G4-3035	\$ 132.69
	G4-3038	132.69
	G4-3021	137.46
	G4-25215	137.46
	G4-2022	137.46
	G4-2023	137.46
	G4-2024	140.61
	G4-1525	145.20
	G4-1526	151.35
	G4-1228	156.00
	G4-1011	163.46
	G4-612	163.46
	G4-514	163.46
	Type G5 Mica Capacitors:	
	G5-5045	265.80
	G5-3531	278.40
	G5-35325	302.40
	G5-3534	302.40
	G5-3535	326.40
	G5-3521	336.80
	G5-3022	322.80
	G5-30225	328.80
	G5-3023	340.80
	G5-2525	340.80
	G5-2026	340.80
	G5-1511	340.80
204	Type A Mica Capacitors:	
	A-T145087
	A-T131087
	A-T131587
	A-T132087
	A-T132587
	A-T135087
	A-T121087
	A-T122099
	A-T1225	1.02
	A-T1230	1.11
	A-T1240	1.20
	A-T1250	1.26
	A-T1260	1.32
	A-T1280	1.47
	A-T1110	1.68
	A-T1115	1.83
	A-T1120	2.13
	A-T1125	2.61
	A-T1130	2.73
	A-T245096
	A-T231096
	A-T231596
	A-T232096
	A-T232596
	A-T235096
	A-T2210	1.14
	A-T2220	1.50
	A-T2225	1.68
	A-T2230	1.77
	A-T2240	1.86
	A-T2250	1.98
	A-T2260	2.07

Page	ITEM	PRICE	Page	ITEM	PRICE
204	A-T2280	\$ 2.46	204	H-T5350	\$ 1.44
	A-T2110	2.82		H-T5210	1.68
	A-T5450	1.14		H-T5215	2.13
	A-T5310	1.14		H-K1115	1.59
	A-T5325	1.29		H-K1120	1.83
	A-T5350	1.53		H-K1125	2.16
	A-T5210	1.74		H-K1130	2.69
	A-T5220	2.55		H-K2240	1.83
	A-T5225	2.76		H-K2250	1.98
	A-T5230	3.06		H-K2260	1.98
	A-T5240	3.39		H-K2280	2.31
	A-K1140	3.51		H-K2110	3.06
	A-K1150	4.26		H-K5220	2.49
	A-K1160	4.83		H-K5230	2.94
	A-K2115	3.48		H-K5240	3.39
	A-K2120	4.23		H-K5250	3.84
	A-K2125	4.74			
	A-K2130	4.86		Type 71 Paper Capacitors (Filter):	
	A-K5250	3.72		7106-.5	2.82
	A-K5260	3.81		7106-1	3.48
	A-K5280	4.11		7106-2	4.29
	A-K5110	4.38		7106-4	5.46
	A-K5115	4.83		7106-6	6.78
				7106-8	8.10
	Type H Mica Capacitors:			7106-10	9.09
	H-T145072		7110-.1	2.49
	H-T131072		7110-.25	2.82
	H-T132072		7110-.5	2.97
	H-T132572		7110-1	3.81
	H-T133072		7110-2	4.95
	H-T134072		7110-4	6.27
	H-T135072		7110-6	8.43
	H-T121072		7110-8	9.09
	H-T121572		7110-10	10.08
	H-T122078		7110-12	10.89
	H-T122578		7110-15	12.06
	H-T123087		7115-.5	3.81
	H-T124090		7115-1	4.47
	H-T125093		7115-2	6.27
	H-T1260	1.08		7115-4	8.43
	H-T1270	1.11		7115-6	10.23
	H-T1280	1.14		7115-8	12.54
	H-T1110	1.29		7115-10	15.03
	H-T245096		7115-12	16.35
	H-T231096		7115-15	18.00
	H-T232096		7120-.1	3.96
	H-T232596		7120-.25	4.29
	H-T233096		7120-.5	4.47
	H-T234096		7120-1	5.46
	H-T235096		7120-2	6.45
	H-T2210	1.08		7120-4	9.09
	H-T2215	1.38		7120-6	12.06
	H-T2220	1.44		7120-8	15.03
	H-T2225	1.68		7120-10	18.33
	H-T2230	1.83		7120-12	19.98
	H-T5450	1.14		7125-.5	6.93
	H-T5310	1.14		7125-1	7.92
	H-T5320	1.14		7125-2	12.87
	H-T5325	1.32		7125-4	18.00
	H-T5330	1.35		7125-10	45.06
	H-T5340	1.38		7130-.1	8.43

Page	ITEM	PRICE	Page	ITEM	PRICE
206	McIntosh power supply with tube, D-101	\$ 19.50	206	McIntosh 36-watt amplifier, A-116	\$139.50
	McIntosh 50-watt amplifier, 50W-A2	249.50		Equalizer-Preamplifier, less wood cabinet, C-104	49.50
	Plug-in input transformer, for 50, 250, 600 ohms, M-107	23.00		Equalizer-Preamplifier, with wood cabinet, C-104W	57.50
				Announco-note	135.00

207 Type 600 TV Towers:

Cat. No.	Height	Tower Price	Freight	Tower Price Delivered	Concrete Base	Concrete Anchor	Erection Cost	Total Tower Erected
42	200'	\$ 3,550.00	\$300.00	\$ 3,850.00	\$250.00	\$ 350.00	\$ 1,200.00	\$ 5,650.00
42	300'	5,446.00	450.00	5,896.00	300.00	600.00	2,100.00	8,896.00
60	400'	11,280.00	600.00	11,850.00	350.00	900.00	4,000.00	17,130.00
70	400'	14,447.00	700.00	15,147.00	350.00	900.00	4,000.00	20,397.00
80	500'	18,800.00	800.00	19,600.00	500.00	900.00	7,500.00	28,500.00
90	600'	25,500.00	900.00	24,400.00	500.00	1,200.00	10,800.00	36,900.00

Note 1: Erection of any 40' TV antenna on top of above towers, such as RCA 6-bay antenna. — Price, \$3000.00.
 Note 2: Erection of any 80' TV antenna on top of above towers, such as RCA 12-bay antenna. — Price, \$5500.00.
 Note 3: Installation of duplicate 3 1/2" transmission lines. — Per tower foot, \$2.00.
 Note 4: Installation of single 6 1/2" transmission line. — Per tower foot, \$1.50 — Or two 6 1/2" lines, \$3.00 per tower foot.
 Note 5: Antenna erection costs include testing time.
 Note 6: Type 42 towers are galvanized.
 Note 7: For proper tower lights, see Page 209.

Type 12 and 15 Antenna Towers:

Height	Price Type 12	Price Type 12N	Estimated Freight	Erection Charge	Total Type 12	Total Type 12N
150'	\$1,098.00	\$ 948.00	\$ 75.00	\$ 900.00	\$2,073.00	\$1,923.00
160'	1,121.00	961.00	80.00	945.00	2,146.00	1,986.00
170'	1,322.00	1,152.00	85.00	990.00	2,397.00	2,227.00
180'	1,338.00	1,158.00	90.00	1,035.00	2,463.00	2,283.00
190'	1,391.00	1,201.00	95.00	1,080.00	2,566.00	2,376.00
200'	1,439.00	1,239.00	100.00	1,125.00	2,664.00	2,464.00
210'	1,579.00	1,369.00	105.00	1,170.00	2,854.00	2,644.00
220'	1,613.00	1,393.00	110.00	1,215.00	2,938.00	2,718.00
	Price Type 15	Price Type 15N			Total Type 15	Total Type 15N
150'	\$1,366.00	\$1,216.00	\$ 77.00	\$ 900.00	\$2,343.00	\$2,193.00
160'	1,467.00	1,307.00	82.00	945.00	2,494.00	2,334.00
170'	1,590.00	1,420.00	87.00	990.00	2,667.00	2,497.00
180'	1,613.00	1,393.00	92.00	1,035.00	2,740.00	2,520.00
190'	1,674.00	1,484.00	97.00	1,080.00	2,851.00	2,661.00
200'	1,848.00	1,648.00	102.00	1,125.00	3,075.00	2,875.00
210'	1,926.00	1,716.00	107.00	1,170.00	3,203.00	2,993.00
220'	1,960.00	1,740.00	112.00	1,215.00	3,287.00	3,067.00
230'	2,027.00	1,797.00	117.00	1,260.00	3,404.00	3,174.00
240'	2,201.00	1,961.00	122.00	1,305.00	3,628.00	3,388.00
250'	2,290.00	2,040.00	127.00	1,350.00	3,767.00	3,517.00
260'	2,346.00	2,086.00	132.00	1,395.00	3,873.00	3,613.00
270'	2,436.00	2,166.00	137.00	1,440.00	4,013.00	3,743.00
280'	2,565.00	2,285.00	142.00	1,485.00	4,192.00	3,912.00
290'	2,649.00	2,359.00	147.00	1,530.00	4,326.00	4,036.00
300'	2,733.00	2,433.00	152.00	1,575.00	4,460.00	4,160.00
310'	2,822.00	2,512.00	157.00	1,620.00	4,599.00	4,289.00
320'	2,923.00	2,603.00	162.00	1,665.00	4,750.00	4,430.00

Note 1: For tower lights, see Pages 209-212.
 Note 2: Erection includes concrete base, concrete anchors, painting and attachment of lights.
 Note 3: Erection is based on normal soil conditions, but does not include swamp, extreme rocky soil, roof top installations, or where site is not easily accessible.
 Note 4: Catalog numbers 12 and 15 are galvanized towers. Types 12N and 15N are non-galvanized.

Type 15 Towers

Prices all models, with or without erection on application

208 Wincharger Towers:
Types 101, 150 and 300, insulated AM towers.

Tower Height (feet)	Type Tower	Price Galvanized	Price Non-Galvanized	ANCHORS	
				Kit No.	Price
150'	101	\$1,187.00	\$ 973.00	ANC-8	\$ 90.00
160'	101	1,225.00	996.00	ANC-8	90.00
170'	101	1,380.00	1,132.00	ANC-9	94.00
180'	101	1,408.00	1,146.00	ANC-9	94.00
190'	101	1,457.00	1,185.00	ANC-9	94.00
200'	101	1,509.00	1,220.00	ANC-9	94.00
210'	101	1,663.00	1,356.00	ANC-10	135.00
220'	101	1,700.00	1,376.00	ANC-10	135.00
150'	150	1,496.00	1,174.00	ANC-11	49.00
160'	150	1,604.00	1,265.00	ANC-12	98.00
170'	150	1,691.00	1,323.00	ANC-12	98.00
180'	150	1,720.00	1,344.00	ANC-12	98.00
190'	150	1,793.00	1,390.00	ANC-12	98.00
200'	150	1,980.00	1,553.00	ANC-13	98.00
210'	150	2,061.00	1,605.00	ANC-13	98.00
220'	150	2,094.00	1,628.00	ANC-13	98.00
230'	150	2,176.00	1,683.00	ANC-13	98.00
240'	150	2,337.00	1,822.00	ANC-14	146.00
250'	150	2,401.00	1,860.00	ANC-14	146.00
260'	150	2,469.00	1,915.00	ANC-14	146.00
270'	150	2,553.00	1,970.00	ANC-14	146.00
280'	150	2,740.00	2,133.00	ANC-15	146.00
290'	150	2,821.00	2,186.00	ANC-15	146.00
300'	150	2,911.00	2,261.00	ANC-15	146.00
310'	150	3,011.00	2,331.00	ANC-15	146.00
320'	150	3,174.00	2,473.00	ANC-16	195.00
150'	300	2,615.00	2,014.00	ANC-11	49.00
160'	300	2,721.00	2,082.00	ANC-11	49.00
170'	300	2,835.00	2,158.00	ANC-11	49.00
180'	300	2,949.00	2,233.00	ANC-11	49.00
190'	300	3,190.00	2,424.00	ANC-12	98.00
200'	300	3,289.00	2,486.00	ANC-12	98.00
210'	300	3,414.00	2,572.00	ANC-12	98.00
220'	300	3,513.00	2,634.00	ANC-12	98.00
230'	300	3,627.00	2,710.00	ANC-12	98.00
240'	300	3,909.00	2,938.00	ANC-13	98.00
250'	300	4,010.00	3,003.00	ANC-13	98.00
260'	300	4,110.00	3,066.00	ANC-13	98.00
270'	300	4,237.00	3,151.00	ANC-13	98.00
280'	300	4,347.00	3,225.00	ANC-13	98.00
290'	300	4,606.00	3,432.00	ANC-14	146.00
300'	300	4,735.00	3,521.00	ANC-14	146.00
310'	300	4,869.00	3,615.00	ANC-14	146.00
320'	300	4,965.00	3,674.00	ANC-14	146.00
330'	300	5,080.00	3,751.00	ANC-14	146.00
340'	300	5,387.00	4,002.00	ANC-15	146.00
350'	300	5,519.00	4,094.00	ANC-15	146.00
360'	300	5,650.00	4,186.00	ANC-15	146.00
370'	300	5,760.00	4,258.00	ANC-15	146.00
380'	300	5,863.00	4,322.00	ANC-15	146.00
390'	300	6,194.00	4,595.00	ANC-16	195.00
400'	300	6,293.00	4,659.00	ANC-16	195.00
410'	300	6,412.00	4,740.00	ANC-16	195.00
420'	300	6,530.00	4,817.00	ANC-16	195.00
430'	300	6,667.00	4,914.00	ANC-16	195.00
440'	300	6,759.00	4,969.00	ANC-16	195.00

Note 1: For tower lights, see Pages 209-212.
Note 2: Prices do not include erection.

208 Types 47, 78, 101, 150, 300, non-insulated towers.
(For Supporting High Frequency Antennas). (Not for AM Radio Broadcasting).

Tower Height	Type Tower	Tower Price	ANCHOR		Tower Height	Type Tower	Tower Price	ANCHOR	
			Kit No.	Price				Kit No.	Price
35'	47	\$ 127.00	ANC-5.....	\$ 21.00	230'	150	\$1,673.00	ANC-14.....	\$146.00
45'	47	173.00	ANC-5.....	21.00	240'	150	1,708.00	ANC-14.....	146.00
55'	47	198.00	ANC-5.....	21.00	250'	150	1,785.00	ANC-14.....	146.00
65'	47	224.00	ANC-5.....	21.00	260'	150	1,921.00	ANC-14.....	146.00
75'	47	246.00	ANC-5.....	21.00	270'	150	1,996.00	ANC-14.....	146.00
85'	47	273.00	ANC-5.....	21.00	280'	150	2,042.00	ANC-14.....	146.00
95'	47	348.00	ANC-5.....	21.00	290'	150	2,126.00	ANC-14.....	146.00
105'	47	371.00	ANC-5.....	21.00	300'	150	2,161.00	ANC-14.....	146.00
115'	47	404.00	ANC-5.....	21.00	310'	150	2,253.00	ANC-14.....	146.00
125'	47	446.00	ANC-17.....	42.00	320'	150	2,383.00	ANC-14.....	146.00
65'	78	339.00	ANC-5.....	21.00	180'	300	2,301.00	ANC-12.....	98.00
75'	78	375.00	ANC-5.....	21.00	190'	300	2,421.00	ANC-12.....	98.00
85'	78	409.00	ANC-5.....	21.00	200'	300	2,513.00	ANC-12.....	98.00
95'	78	514.00	ANC-5.....	21.00	210'	300	2,728.00	ANC-14.....	146.00
105'	78	549.00	ANC-5.....	21.00	220'	300	2,831.00	ANC-14.....	146.00
115'	78	584.00	ANC-5.....	21.00	230'	300	2,941.00	ANC-14.....	146.00
125'	78	659.00	ANC-17.....	42.00	240'	300	3,045.00	ANC-14.....	146.00
135'	78	699.00	ANC-17.....	42.00	250'	300	3,154.00	ANC-14.....	146.00
145'	78	738.00	ANC-17.....	42.00	260'	300	3,360.00	ANC-14.....	146.00
155'	78	783.00	ANC-17.....	42.00	270'	300	3,474.00	ANC-14.....	146.00
150'	101	826.00	ANC-8.....	90.00	280'	300	3,574.00	ANC-14.....	146.00
160'	101	861.00	ANC-8.....	90.00	290'	300	3,700.00	ANC-14.....	146.00
170'	101	982.00	ANC-9.....	94.00	300'	300	3,795.00	ANC-14.....	146.00
180'	101	1,018.00	ANC-9.....	94.00	310'	300	3,925.00	ANC-14.....	146.00
190'	101	1,060.00	ANC-9.....	94.00	320'	300	4,033.00	ANC-14.....	146.00
200'	101	1,101.00	ANC-9.....	94.00	330'	300	4,150.00	ANC-14.....	146.00
210'	101	1,209.00	ANC-10.....	135.00	340'	300	4,261.00	ANC-14.....	146.00
220'	101	1,245.00	ANC-10.....	135.00	350'	300	4,367.00	ANC-14.....	146.00
160'	150	1,113.00	ANC-8.....	90.00	360'	300	4,572.00	ANC-16.....	195.00
170'	150	1,264.00	ANC-12.....	98.00	370'	300	4,698.00	ANC-16.....	195.00
180'	150	1,291.00	ANC-12.....	98.00	380'	300	4,801.00	ANC-16.....	195.00
190'	150	1,356.00	ANC-12.....	98.00	390'	300	4,915.00	ANC-16.....	195.00
200'	150	1,382.00	ANC-12.....	98.00	400'	300	5,026.00	ANC-16.....	195.00
210'	150	1,563.00	ANC-14.....	146.00	410'	300	5,143.00	ANC-16.....	195.00
220'	150	1,597.00	ANC-14.....	146.00	420'	300	5,413.00	ANC-16.....	195.00
					430'	300	5,555.00	ANC-16.....	195.00
					440'	300	5,683.00	ANC-16.....	195.00

Note 1: All towers galvanized.
Note 2: See Pages 209-212 for tower lights.
Note 3: Prices do not include erection.
Note 4: Towers shipped knocked down.

Page	ITEM	PRICE	Page	ITEM	PRICE
209	Complete kit 1C-2 for towers up to 150 feet, conduit wiring	Kit Price \$ 96.00			
				Wire per tower foot \$.54	
	Complete kit 1E-2 for towers up to 150 feet, exposed wiring	91.00			.24
	Complete kit 2C1-2 for towers 150 feet to 300 feet, conduit wiring	431.00			.80
	Complete kit 2E1-2 for towers 150 feet to 300 feet, exposed wiring	426.25			.60
	Complete kit 3C1-4 for towers 300 feet to 450 feet, conduit wiring	486.25			.85
	Complete kit 3E1-4 for towers 300 feet to 450 feet, exposed wiring	480.50			.65
209	Complete kit 4C2-6 for triangular towers 450 feet to 600 feet, conduit wiring ..	Kit Price \$ 1,930.00			\$1.20
	Complete kit 4C2-8 for 4 legged towers 450 feet to 600 feet, conduit wiring	1,990.00			1.30
	Complete kit 5C2-9 for triangular towers 600 feet to 700 feet, conduit wiring	2,209.00			1.40
	Complete kit 5C2-12 for 4 legged towers, 600 feet to 750 feet, conduit wiring	2,357.50			1.55
	Complete kit 6C3-9 for triangular towers 750 feet to 900 feet, conduit wiring	2,624.00			1.55
	Complete kit 6C3-12 for 4 legged towers 750 feet to 900 feet, conduit wiring	2,759.50			1.70

Page	ITEM	PRICE	Page	ITEM	PRICE
209	Complete kit 7C3-12 for triangular towers 900 feet to 1050 feet, conduit wiring.....	Kit Price \$ 2,815.00			Wire per tower foot \$ 1.70
	Complete kit 7C3-16 for 4 legged towers 900 feet to 1050 feet, conduit wiring	2,990.00	1.85		
	Note 1: Telltale and alarm panel (not mandatory to meet FCC specifications) available at following added prices:				
	Kit 4C2-6	\$ 384.00			
	Kit 4C2-8	394.00			
	Kit 5C2-9	460.00			
	Kit 5C2-12	472.50			
	Kit 6C3-9	486.00			
	Kit 6C3-12	496.00			
	Kit 7C3-12	520.50			
	Kit 7C3-16	530.00			
	Note 2: For tower light kits above 1050 feet, prices on application.				
	Note 3: Tower light kits are shipped with freight allowed to nearest common carrier point. Shipment is made transportation collect with freight credit shown on invoice.				
210	Lights and Controls:				
	113-KG 300MM Code Beacon with 2 Red Color Screens	245.44			
	114-KG 300MM Code Beacon with 2 Red Color Screens	284.13			
	OB10-M Single Obstruction Light	12.47			
	OB10-MP Single Obstruction Light	14.55			
	OB10-S Single Obstruction Light	18.48			
	OB11-M Double Obstruction Light	24.95			
	OB11-MP Double Obstruction Light	29.11			
	OB11-S Double Obstruction Light	49.90			
	SF-30E Mercury Flasher	57.58			
	SF-80 Mechanical Flasher	77.96			
	SF-85 Mechanical Flasher	86.63			
	SF-90 Mechanical Flasher	98.18			
	PECA-2 Photo-Electric Control (400 w)	86.63			
	PECA-3 Photo-Electric Control (1800 w)	127.05			
	PECA-3DP Photo-Electric Control Double Pole (1800 w)..	150.15			
	PECA-4 Photo-Electric Control (3000 w)	155.93			
	PECA-4DP Photo-Electric Control Double Pole (3000 w)..	179.03			
	PECA-5 Photo-Electric Control (4400 w)	190.58			
	PECA-5DP Photo-Electric Control Double Pole (4400 w)..	213.68			
	Note: PECA controls are single pole except those with suffix "DP" which are double pole.				
	Bulbs only:				
	PS-40 beacon light, 500 watt, 125 volt, one focus mogul base	1.50			
	A-21 clear traffic light A-21, 125 volt44			
211	Kit A3-GCK lighting as illustrated	\$ 454.61			
	Wire, per tower foot for above75			
212	Kit A3-EWK lighting as illustrated	454.61			
	Wire, per tower foot for above46			
	How to order any kit: Take price of tower kit and add to tower height price of wire per tower foot. Example: Kit A3-EWK for a 200' tower would be \$454.61 + \$92.00, or total of \$546.61. The same applies to all kits listed on Page 209.				
213	3/8" Type 83 Coaxial Cable:				
	Type 83 coaxial cable	per ft. .50			
	(Reel deposit additional—refunded on return)				
	8319 solid connectors75			
	1701P end terminal	7.00			
	1701GV end terminal	8.75			
	1701R end terminal	8.75			
	853 right angle box	2.50			
	825 T junction box	4.50			
	830 collar clamp	1.90			
	915 coupling	6.25			
	915R coupling	8.75			
	7/8" Type 737 Coaxial Cable:				
	Type 737 coaxial cable	per ft. 1.10			
	(Reel deposit additional—refunded on return)				
	8329 reducer coupling	3.75			
	4876-1 adaptor	14.00			
	8328B solder connector	1.60			
	8328G pair solder connectors	1.60			
	1703P end terminal	9.50			
	1703GV end terminal	11.25			
	1703R end terminal	11.25			
	61 right angle junction box	5.00			
	6500 right angle bend	5.00			
	65 T junction box	8.25			
	859 Y junction box	15.00			
	829 collar clamp	3.25			
	4878 split collar clamp	3.75			
	917 coupling	5.75			
	917R coupling	8.25			
	917GV coupling	8.25			
	L-12423 adaptor	17.50			
	L-13223-1 pair swivel flanges	8.75			
	L-13223-2 single swivel flange	5.00			
	1 1/2" Type 451 Coaxial Cable:				
	Type 451 coaxial cable, Per 20 ft. length	55.00			
	451-1, same as 451 but flange one end only	50.00			
	451-2, same as 451 but no flanges..	45.00			
	M-13941 right angle bend	40.00			
	M-13941-1, same as M-13941 but flange one end only	36.00			
	M-13941-2, same as M-13941 but no flanges	32.00			
	M-14216 45° bend	40.00			

Page	ITEM	PRICE	Page	ITEM	PRICE
213	M-14216-1, same as M-14216 but flange one end only	\$ 36.00	214	3 1/8" Type 452 Coaxial Cable:	
	M-14216-2, same as M-14216 but no flanges	32.00		20' section 452 coaxial cable	\$ 115.00
	K-13273 special angle bend	70.00		452-1, same as 452 but flange one end only	105.00
	T-1551 clamp connector	12.50		452-2, same as 452 but no flanges..	97.00
	T-1251 gas barrier	32.00		T-1052 right angle bend	48.00
	T-1851 reducer connector	44.00		T-1052-1, same as T-1052 but flange one end only	43.00
	T-4831 ungasged reducer	26.00		T-1052-2, same as T-1052 but no flanges	38.00
	T-4832 ungasged straight coupling	3.75		T-1152 45° bend	70.00
	L-12859 tapered adaptor	32.00		T-1152-1, same as T-1152 but flange one end only	65.00
	2451 hardware kit	12.50		T-1152-2, same as T-1152 but no flanges	60.00
	M-12211 special length line	19.00 + 20c per inch		T-1952 special angle bend	85.00
	M-13280 special length line per inch20		T-1552 clamp connector	20.00
	M-12843-5 five-foot length	19.00		T-1252 gas barrier	42.00
	M-12843-10 ten-foot length	30.00		T-1851 reducer	44.00
	M-12843-15 fifteen-foot length	40.00		T-4831 reducer	26.00
	L-11809-2 extra clamp55		T-4838 coupling	8.25
	L-11381-2 set hardware65		M-12173 special length	37.50 + 38c per inch
	K-10875 flange	1.60		M-13278 special length ... per inch	.38
	K-10419-2 silver solder ring15		M-12844-5 five-foot length	35.00
	K-14485 rotating and fixed ring ..	2.85		M-12844-10 ten-foot length	55.00
	K-12233-2 inner conductor tube ...	3.75		M-12844-15 fifteen-foot length ...	72.00
	L-10683-2 rubber gasket25		L-11809-1 extra clamp75
	K-12234-1 cover plate	4.50		K-12233-3 inner conductor tube ..	.15
	T-4837 clamp connector	7.50		L-10683-3 rubber gasket45
	1351 gas inlet coupling	12.50		K-12234-2 blank cover plate	6.25
	K-13944 inner connector	2.50		1352 gas inlet coupling	15.00
	K-14156 inner connector	2.00		2452 hardware kit	18.00
	K-12430 clamp and grounding strap	6.25		K-14417 inner connector	5.14
214	1 5/8" Type 551-4 Coaxial Cable:			L-12650-2 inner connector	1.60
	20' section No. 551-4	74.00		K-14486 rotating and fixed ring ..	6.50
	M-13981 special length	19.00 + 25c per inch		K-13244-1 inner conductor	3.45
	M-12514 reducer connector	37.00		L-11381-3 set of hardware	1.15
	1551 clamp connector	12.00		L-10881 flange	6.00
	M-13941 90° bend	40.00		K-10419-11 silver ring25
	M-13941-1 90° bend	36.00		K-12431 clamp and grounding strap	8.75
	M-13941-2 90° bend	32.00		3 1/8" Type 552-1 Coaxial Cable:	
	M-14216 45° bend	40.00		20' section 552-1	140.00
	M-14216-1 45° bend	36.00		M-12512 right angle bend	66.00
	M-14216-2 45° bend	32.00		M-12513 45° bend	56.00
	K-13273 special bend	70.00		M-13928 special angle bend	75.00
	T-1251 gas barrier	32.00		M-12514 reducer connector	37.50
	T-1851 reducer	44.00		L-12515 clamp connector	18.75
	L-10683-2 rubber gasket25		L-13163 gas barrier	44.00
	K-12234-1 blank flange	4.50		K-13244-1 reducer	3.45
	1351 gas inlet	12.50		M-13325 special length	37.00 + 44c per inch
	L-12859 reducer	32.00		L-12650-3 inner connector	1.75
	2451 hardware kit	12.50		K-13946 inner connector	3.15
	L-11381-2 hardware kit65		2552 hardware kit	19.00
	K-10875 flange	1.60	215	L-10683-3 rubber gasket45
	K-10419-2 solder ring15		K-12234-2 blank flange	6.25
	K-14485 swivel flange	2.85		L-11381-3 hardware kit	6.50
	K-13944 inner connector	2.50			
	L-14156 inner connector	2.00			
	K-12430 grounding strap	6.25			

Page	ITEM	PRICE	Page	ITEM	PRICE	
215	L-10881 flange	\$ 6.50	216	6 1/8" Coaxial Cable for UHF:		
	K-10419-11 solder ring25		All types quoted per your diagram of layout.		
	K-12431 grounding strap	8.75		WR-1500 Aluminum Waveguide:		
	K-14486 swivel flange	6.50		M-14710 twelve-foot section	\$ 260.00	
	K-13244-1 inner adaptor	3.45		M-14711 E plane bend	330.00	
	6 1/8" Type T-453 Coaxial Cable:			M-14712 H plane bend	330.00	
	20' section T-453	380.00		M-14713 adaptor	300.00	
	T-1053 right angle bend	165.00		M-14714 spring hangars	33.00	
	T-1153 45° bend	165.00		WR-1150 Aluminum Waveguide:		
	T-1953 special angle bend	250.00		M-14715 twelve-foot section	235.00	
	T-1253 gas barrier	105.00		M-14716 E plane bend	280.00	
	1353 gas inlet coupling	25.00		M-14717 H plane bend	280.00	
	1553 clamp connector	35.00		M-14718 adaptor	225.00	
	T-1852 reducer	60.00		M-14719 spring hangars	30.00	
	2453 hardware kit	25.00		Solid Dielectric Line:		
	L-11381-4 set of hardware	2.50		Cat. No.	Price 100-999 ft. (per ft.)	Price over 1000 ft. (per ft.)
	L-11271 flange	12.50		RG8U	\$.14	\$.13
	K-10419-30 silver ring50		RG9U32	.31
	L-10683-10 rubber gasket60		RG11U13	.12
	K-14418 inner connector	13.00		RG12U27	.26
	K-14675 rotating and fixed ring ..	25.00		RG17U63	.62
	N-12681 special length	100.00 + 1.25 per inch		RG19U97	.96
	1 1/8" Type 561 Teflon UHF Line:			RG22U16	.16
	All items	on application		RG22AU28	.28
	3 1/8" Type 562 Teflon UHF Line:			RG58U08	.07
	20' length 562 line (channels 14-15)	160.00		RG58AU08	.07
	562-3, same as 562 but channels 46-83	160.00		RG59U08	.07
	1062 right angle bend	75.00	217	M-3327 transmission line bracket	21.00	
	1162 45° bend	75.00		M-2856 transmission line bracket	15.00	
	1262 gas barrier	47.00		M-2857 end plate	25.00	
	1362 gas inlet coupling	17.00		M-3328 end plate	38.00	
	1562 clamp connector	22.00	218	M-3322 horn gap assembly	42.00	
	1861 reducer	48.00		M-3864 center post assembly	8.50	
	1962 special angle bend	85.00		M-2870A feed-thru bowl	9.00	
	2462 hardware kit	28.00		M-2870B feed-thru bowl	9.00	
	2762 special length of 562-3 line	47.00 + 60c per inch		M-2870C feed-thru bowl	9.00	
	2862 special length of 562-5 line	47.00 + 60c per inch		M-2870D feed-thru bowl	9.00	
	216 1900 automatic dehydrator	450.00		The following are similar to above feed-thru bowls but have tubular center studs instead of solid center studs.		
	1901 spare parts kit	12.50		MO-3110 feed-thru insulator, 10" stud for 3" wall	9.00	
	878 dry air pump	45.00		MO-3111 feed-thru insulator, 8" stud for 1" wall	9.00	
	210 silica gel refill	2.50		MO-3137 feed-thru insulator, 1 1/2" for 6" wall	9.00	
	879 air drying hose	15.00		Note: Gates will gladly quote on galvanized poles, or other materials for open wire line equipment, on receipt of sketch or specifications.		
	K-14744 air drying hose	12.00	219	Auditory training unit CD-1	2,160.00	
	858 fittings for nitrogen tank	39.00		Control knob GK-53 (less than 50)90	
	L-10513-3 nitrogen gas 12.3 cu. ft. ..	25.00		Control knob GK-53 (more than 50)81	
	L-10513-6 nitrogen gas 78 cu. ft. ...	60.00		Color coding kit for knobs DC-53	2.50	
	L-10513-5 nitrogen gas 112 cu. ft. ..	68.00				
	L-10513-8 nitrogen gas 224 cu. ft. ..	83.00				
	6600 gas dist. manifold	13.00 + 6.00 per outlet				
	T-4833 line gassing kit	18.75				

Page	ITEM	PRICE	Page	ITEM	PRICE
219	Copper ground screen GS-8	\$ 35.00	234	Projector, LT-16	\$ 1,800.00
	Copper ground wire W-10..per cwt.	57.00		Remote control unit, LR-16	25.00
	Ground rods GR-6	1.80		3 point pedestal	125.00
	Ground rods GR-8	3.25		2½" lens, LL-2½	100.00
	Soldering irons, 60 watt, No. 2128	3.67		3" lens, LL-3	125.00
	Soldering irons, 100 watt, No. 3138	5.83		3½" lens, LL-3½	150.00
	Soldering irons, 200 watt, No. 3158	6.85		4" lens, LL-4	175.00
	Soldering irons, 300 watt, No. 3178	9.00		Shadow box, LSB-16	445.00
	Soldering irons, 550 watt, No. 3198	11.00		Dual stand, LIP-16	375.00
	Touch-up paint, PA-19			4000' empty reel, LRR-16	24.00
	(state color)	1.75		Extra 1000 watt 115 volt	
	Lead covered wire, LE-2-12..per ft.	.20		projection lamp	6.00
	Lead covered wire, LE-2-18..per ft.	.12	235	UHF Transmitting Antennas:	
	Ground strap, CS-2.....per ft.	.16		Type WA-14, Channels 24 to 24	7,000.00
	Ground strap, CS-4.....per ft.	.27		Type WA-14, Channels 25 to 43	6,500.00
	Tower lamp, LL-A2144		Type WA-14, Channels 44 to 83	6,000.00
	Tower lamp, LL-PS40	1.50		Type WA-25, Channels 14 to 24	14,500.00
	Note: All copper products such as ground			Type WA-25, Channels 25 to 43	13,000.00
	wire, ground strap, ground rods, cop-			Type WA-25, Channels 44 to 83	12,000.00
	per screen, subject to market fluctu-			6-Bay UHF Antennas:	
	ation either upward or downward,			(Now available but not listed in catalog.)	
	and prices will be billed according to			Gain approximately 7.	
	market at time of shipment.			Channels 14 to 24	4,000.00
221	All items this page	on application		Channels 25 to 43	3,750.00
228	Television transmitter, BT1A-L	22,000.00		Channels 44 to 83	3,500.00
	Television transmitter, BT1A-H	24,000.00		Note: UHF TV antennas are tested to your	
	100% tube set, TK-160	395.00		channel frequency. Prices are F.O.B.	
229	Television transmitter, BT5A-L	48,500.00		Norwood, Mass.	
	Television transmitter, BT5A-H	52,500.00		Where Null fill-in and beam tilt is	
	100% tube set, TK-161	1,263.00		desired, add \$500.00.	
232	Television transmitter,			Shipping time 90 days or less.	
	BT-1000A	on application			
	Tube set, TK-162	on application			

All prices in this price list subject to change without notice.



MANUFACTURING ENGINEERS SINCE 1922

Make Gates Your One Source of Supply

For All

Broadcasting Equipment Needs

If You Didn't Get This From My Site,
Then It Was Stolen From...

www.SteamPoweredRadio.Com

You Can Order from



Gates Radio Company
123 Hampshire Street
Quincy, Ill.
Tel. 8202

Gates Radio Company
Warner Building
Washington 4, D. C.
Tel. Metropolitan 8-0522

Gates Radio Company
51 E. 42nd Street
New York 17, N. Y.
Tel. Mu-Hill 7-7971

Gates Radio Company
2700 Polk Ave.
Houston 3, Texas
Tel. Atwood 8536

Gates Radio Company
7501 Sunset Blvd.
Los Angeles 46, Calif.
Tel. Hollywood 2-6351

Gates Radio Company*
13th & Spring Streets
Atlanta, Ga.

Canadian Marconi Company
2442 Trenton Ave.
Montreal, Que., Canada
Tel. Atlantic 9441

Gates Radio Company
International Division
13 E. 40th Street
New York 16, N. Y.
Tel. Mu-Hill 9-0200

*Atlanta Branch Open September 1, 1953.

➡ Quincy, Houston, Los Angeles and Atlanta—
all stock carrying and distributing branches



GATES RADIO COMPANY

MANUFACTURING ENGINEERS SINCE 1922

QUINCY, ILLINOIS, U. S. A.

If You Didn't Get This From My Site,
Then It Was Stolen From...