

ALTEC

LANSING CORPORATION

A Subsidiary of Ling-Temco-Vought, Inc.



RECORDING, MOTION PICTURE,
AUDIO-VIDEO and
BROADCASTING STUDIO

SPEECH-INPUT and
PLAYBACK
EQUIPMENT



- ★ **MICROPHONES**
CARDIOID — OMNIDIRECTIONAL — CONDENSER — DYNAMIC
- ★ **CONSOLES**
STANDARD AND CUSTOM
- ★ **AMPLIFIERS**
LINE — BOOSTER — PROGRAM — MIXER — COMPRESSOR
LIMITER — MONITOR — PRE-RECORDING —
REMOTE — PLAYBACK
- ★ **EQUALIZERS**
PROGRAM — GRAPHIC — MICROPHONE
- ★ **FIXED FILTERS**
- ★ **ATTENUATORS**
- ★ **MIXER NETWORKS**
- ★ **MATCHING and FIXED LOSS PADS**
- ★ **VARIABLE HIGH and LOW PASS FILTERS**
- ★ **SPEAKER SYSTEMS**
MONITOR — PLAYBACK
- ★ **TRANSFORMERS**
MATCHING — LINE

If You Didn't Get This From My Site,
Then It Was Stolen From...

www.SteamPoweredRadio.Com

1515 SOUTH MANCHESTER AVENUE — ANAHEIM, CALIFORNIA

ALTEC LANSING
1515 South Manchester Ave.
Anaheim, California

INDEX
SPEECH INPUT AND
PLAYBACK EQUIPMENT

April 21, 1965

<u>Product or Part Number</u>	<u>Latest Issue</u>
<u>Recording and Broadcast Studio Equipment Price List</u>	
<u>Attenuators, Equalizers, Filters, Switches</u>	
60A Microphone Equalizers	AL-1488
61A and 63A Program Equalizers	AL-1486-1
62A, 72A, 73A, 74A Graphic Equalizers	AL-1489-1
64A, 65A, 66A and 71A Fixed Filters and Attenuators	AL-1491-1
67A, 68A, and 69A Variable High and Low Pass Filters	AL-1487
8000, 8001, 8002, 8003, 8004, and 8005 Mixer Networks, Matching Pads and Fixed Loss Pads	AL-1490
Altec Attenuators	AL-1496
<u>Source</u>	
Altec Microphones	AL-1327-F-1
632C Dynamic Microphone	AL-1407-1
Altec Microphones and Accessories	AL-1327-H-1
Altec Microphones	AL-1327-G-1
Altec Microphone Accessories	AL-1439-6
<u>Amplification</u>	
250 SU Control Console	AL-1448-4
Altec Stereo Tuner-Preamp and Power Amplifiers	AL-1327-C-1
361A Mixer/Power Amplifier	AL-1483
Altec Amplifiers and Preamplifiers	AL-1327-E-1
470A Amplifier	AL-1481
474A Amplifier	AL-1484
475A Amplifier	AL-1485
Altec Amplifier Accessories	AL-1440-5
<u>Loudspeakers</u>	
Altec A-7 -- A7-500 Speaker Systems	AL-1327-A-1
Altec Full Range Speakers	AL-1327-B-1
Monitor/Playback Speaker System	AL-1495
604E Super Duplex Loudspeaker	AL-1492-1
70 & 25 Volt Line Transformers	AL-1438-7

ALTEC LANSING

A DIVISION OF *ALTEC* LING ALTEC, INC.

1515 SOUTH MANCHESTER AVENUE, ANAHEIM, CALIFORNIA • 92803
774-2900 AREA CODE 714

RECORDING AND BROADCAST STUDIO EQUIPMENT PRICE LIST*

EFFECTIVE JULY 1, 1965

ORDERING INFORMATION: Altec Studio Equipment is offered at the "Studio Net" prices listed below to professional users in the recording, broadcast, motion picture, and audio-video fields. Altec Studio Equipment is available to such professional users, at these "Studio Net" prices, through Authorized Altec Recording and Broadcast Distributors and Authorized Altec Sound Contractors.

Any direct sales will be f.o.b. Altec's Anaheim, plant or New York warehouse.

DESCRIPTION		STUDIO NET	APPROX. SHIPPING WEIGHT
4A	Microphone Switch	\$ 24.00	1
7A	Microphone Switch Kit	8.25	1
A7	VOICE OF THE THEATRE System	288.00	154
A7-W	VOICE OF THE THEATRE System, Walnut	372.00	154
A7-500	VOICE OF THE THEATRE System	315.00	160
A7-500W	VOICE OF THE THEATRE System, Walnut	399.75	160
8B	Microphone Attachment	21.75	0.5
9A	Microphone Attachment	9.00	0.5
11A	Microphone Attachment	27.00	1
M-20	Condenser Microphone System	233.00	10
21D	Condenser Microphone Head	75.00	1
22C	Microphone Floor Stand	19.00	17
23A	Microphone Desk Stand	18.00	4
24C	Microphone Desk Stand	13.50	4
26A	Microphone Desk Stand	15.00	2
29B	Condenser Microphone Head	73.00	1
M-30	Condenser Microphone System	252.00	10
34A	Mic. Desk Stand with Shock Mtg.	12.00	4
100A	Bass Energizer	30.00	1
128B	Amplifier (40 watt)	240.00	45
159B	Probe Tube	28.00	1
165A	Microphone Lipstik Base (21 type)	66.00	1
166A	Microphone Stand Holder	4.50	1
167A	Microphone Extension Cable	34.50	1
168A	Wind Screen (21D)	10.75	1

*Prices subject to change without notice.

RECORDING AND BROADCAST STUDIO EQUIPMENT PRICE LIST
EFFECTIVE JULY 1, 1965

DESCRIPTION		STUDIO NET	APPROX. SHIPPING WEIGHT
169A	Microphone Shock Mount (175A Base)	\$ 13.50	1
170B	Wind Screen (29B)	16.50	1
175A	Microphone Lipstik Base (29 type)	72.00	1
181B	Microphone Boom Mount	27.00	2
250 SU	Console	1,393.00	126
311A	Microphone Plug	24.00	2
314A	PLAYBACK Stereo FM Tuner	337.00	24
351B	Amplifier	234.00	19
360B	PLAYBACK Stereo Pre/Power Amplifier	389.00	28
361A	Amplifier (18/25 watts)	135.00	28
402D	8" L.F. Speaker	19.50	3
412C	12" BIFLEX Speaker	57.00	16
414A	12" L.F. Speaker	54.00	16
415C	15" BIFLEX Speaker	67.50	19
416A	15" L.F. Speaker	63.00	19
436C	Compressor Amplifier	165.00	17
438C	Compressor Amplifier	199.00	17
442A	Microphone Jack	15.75	0.5
458A	Preamplifier	120.00	6
459A	Line Amplifier	148.00	6
N-500D	Network (500 cps)	52.50	8
511B	H.F. Horn	36.00	18
525A	Microphone Power Supply	100.00	9
535A	Power Supply	183.00	29
601C	12" DUPLEX Speaker	114.00	18
602C	15" DUPLEX Speaker	132.00	21
604E	SUPER DUPLEX Speaker	199.00	40
605B	15" DUPLEX Speaker	168.00	36
612A-B	Cabinet (Utility Large)	80.00	53
614A-B-C	Cabinet (Utility Medium)	72.50	32
618B-C	Cabinet (Utility Small)	40.00	20
622B	Cabinet (Wall)	39.00	20
632C	Microphone	52.00	3
633A	Microphone	54.00	3
633C	Microphone	66.00	3
639A-B	Microphone	302.00	7
681A*	Microphone (green or chrome, high or low impedance)	46.50	1
682A#	Microphone (green, chrome, platinum)	54.00	1
683A#	Microphone (green, chrome, platinum)	76.50	1
684A	Microphone (green)	78.00	3

*Specify high or low impedance. Specify color.
#Specify color

RECORDING AND BROADCAST STUDIO EQUIPMENT PRICE LIST
EFFECTIVE JULY 1, 1965

DESCRIPTION		STUDIO NET	APPROX. SHIPPING WEIGHT
685A	Microphone (green)	\$ 96.00	3
686A	Microphone (green)	45.00	2
688A	Microphone (green)	90.00	3
689A	Microphone (green)	108.00	3
697A	Noise Cancelling Dynamic Microphone	51.75	2
708A	Astro AM/FM Stereo Tuner Amplifier	560.00	40
712A	Microphone Adapter	6.75	0.5
713A	Microphone Adapter	3.50	0.5
755C	8" Speaker	32.25	7
N-800D	Network (800 cycles)	39.00	8
N-800E	Network (800 cycles)	46.50	5
802D	H.F. Driver	75.00	9
806A	H.F. Driver (500-22,000)	57.00	8
811B	H.F. Horn	24.00	11
825	L.F. Horn	100.00	100
831A	CAPISTRANO Speaker System (Walnut)	399.00	133
836A	LIDO Speaker System (Walnut)	112.50	40
837B	AVALON Speaker System (Walnut)	297.00	107
838B	CARMEL Speaker System (Walnut)	346.50	117
841B	CORONADO Speaker System (Walnut)	214.50	58
843A	MALIBU Speaker System (Walnut)	357.00	120
844A	Monitor/Playback Speaker System	294.30	100
845A	VERDE Speaker System (Walnut)	96.00	30
846A	VALENCIA Speaker System (Walnut)	333.00	100
855A	Cabinet, Walnut (15" speaker)	126.00	80
856A	Cabinet, Walnut (A7)	183.00	100
857A	Monitor Speaker Cabinet (15" speaker)	71.55	50
858A	Cabinet (Walnut)	114.00	80
859A	Cabinet (Walnut)	147.00	75
1566A	Preamplifier	87.00	14
1567A	Mixer Preamplifier	189.00	24
1578A	Preamplifier	18.00	1
1579A	Phono-Preamplifier	24.00	1
1883-H6	Microphone Tensolite Cable	.30/ft.	--
2000B	H.F. Speaker	22.50	2
3000B	H.F. Speaker	40.50	2
N-3000E	Network	21.00	2
4665	Microphone Transformer	33.00	1
4722	Microphone Transformer	12.75	1
5426	Microphone Cable	.35/ft.	--

RECORDING AND BROADCAST STUDIO EQUIPMENT PRICE LIST
EFFECTIVE JULY 1, 1965

DESCRIPTION		STUDIO NET	APPROX. SHIPPING WEIGHT
5981	Tube Test Meter (250 SU)	\$ 21.00	1
7160	VU Meter (250 SU)	33.00	1
8000-2	Mixer Network	10.80	1
8000-3	Mixer Network	12.15	1
8000-4	Mixer Network	13.05	1
8000-5	Mixer Network	14.40	1
8000-6	Mixer Network	15.75	1
8000-7	Mixer Network	17.10	1
8000-8	Mixer Network	18.90	1
8000-9	Mixer Network	20.25	1
8000-10	Mixer Network	21.60	1
8000-11	Mixer Network	23.40	1
8000-12	Mixer Network	27.00	1
8000-13	Mixer Network	28.80	1
8000-14	Mixer Network	30.60	1
8000-15	Mixer Network	32.40	1
8000-16	Mixer Network	35.10	1
8001-2	Mixer Network	7.43	1
8001-3	Mixer Network	8.55	1
8001-4	Mixer Network	9.45	1
8001-5	Mixer Network	10.80	1
8001-6	Mixer Network	12.15	1
8001-7	Mixer Network	13.50	1
8001-8	Mixer Network	14.40	1
8001-9	Mixer Network	15.75	1
8001-10	Mixer Network	17.10	1
8001-11	Mixer Network	18.00	1
8001-12	Mixer Network	18.90	1
8001-13	Mixer Network	20.25	1
8001-14	Mixer Network	21.60	1
8001-15	Mixer Network	22.95	1
8001-16	Mixer Network	24.30	1
8004	Fixed Loss Pad	6.75	1
8005	Fixed Loss Pad	11.50	1
8010	Fixed Loss Pad	15.53	1
8200	Rotary Mixer	18.90	3
8201	Rotary Mixer	18.90	3
8201-Q	Rotary Mixer	21.60	3
8202	Rotary Mixer	27.00	3
8203	Rotary Mixer	37.80	3
8205	Rotary Mixer	39.15	3
8209	Rotary Mixer	29.70	3
8210	Rotary Mixer	35.10	3
8213	Rotary Mixer	48.60	3
8228	Rotary Mixer	32.40	3

RECORDING AND BROADCAST STUDIO EQUIPMENT PRICE LIST
EFFECTIVE JULY 1, 1965

	DESCRIPTION	STUDIO NET	APPROX. SHIPPING WEIGHT
8254	Rotary Mixer	\$ 51.30	3
8272	Straight Line Mixer	37.80	3
8273	Straight Line Mixer	37.80	3
8274	Straight Line Mixer	46.80	3
8276	Straight Line Mixer	51.30	3
8282	Straight Line Mixer	89.10	3
8413	Unbalanced Calibrated Attenuator	39.15	3
8416	Unbalanced Calibrated Attenuator	32.40	3
8470	Balanced Calibrated Attenuator	33.75	3
8701	VU Range Extender	24.30	3
8702	VU Range Extender	27.00	3
8703	VU Range Extender	24.30	3
8705	VU Range Extender	32.40	3
8709	VU Range Extender	36.45	3
8801	Motion Picture Projector and Turntable Fader	29.70	3
8806	Stereo Pan Potentiometer	81.00	3
8807	Stereo Pan Potentiometer	135.00	3
8808	Stereo Pan Potentiometer	37.80	3
8809	Stereo Pan Potentiometer	63.00	3
9060A	Microphone Equalizer	202.50	4
9061A	Program Equalizer	225.00	4
9062A	Graphic Equalizer	526.50	15
9063A	Program Equalizer	308.00	16
9064A	Notch Filter - single notch above 60 cycles	90.00	4
9064A	Notch Filter - single notch below 60 cycles	132.30	4
9064A	Notch Filter - double notch above 60 cycles	180.00	4
9064A	Notch Filter - double notch below 60 cycles	-Special Quote-	
9065A	8KC Fixed LP Filter	27.00	4
9065A	10 KC Fixed LP Filter	27.00	4
9065A	12 KC Fixed LP Filter	27.00	4
9065A	15 KC Fixed LP Filter	27.00	4
9066A	40 cycle Fixed HP Filter	40.50	4
9066A	50 cycle Fixed HP Filter	40.50	4
9066A	70 cycle Fixed HP Filter	40.50	4
9066A	100 cycle Fixed HP Filter	40.50	4
9067A	Variable Hi/Lo Pass Filter	279.00	20
9068A	Variable Low Pass Filter	103.50	4
9069A	Variable High Pass Filter	108.00	4
9071A	Playback Equalizer	40.50	2
9072A	Graphic Equalizer	567.00	16

RECORDING AND BROADCAST STUDIO EQUIPMENT PRICE LIST
EFFECTIVE JULY 1, 1965

	DESCRIPTION	STUDIO NET	APPROX. SHIPPING WEIGHT
9073A	Graphic Equalizer	\$ 459.00	15
9074A	Graphic Equalizer	486.00	16
9470A	Preamplifier (formerly 470A)	118.80	6
9475A	Preamplifier (formerly 475A)	118.80	6
9550A	Power Supply (formerly 550A)	126.90	25
9611	Escutcheon Plate	2.97	1
9623	Escutcheon Plate	3.65	1
9701	Plug-In Mounting Frame	2.43	1
9702	Plug-In Mounting Frame	2.43	1
9703	Plug-In Mounting Frame	2.57	1
9800	Mounting Frame (formerly 800)	10.80	5
9850	Tray (9470A) (formerly 850)	8.10	1
9852	Tray (9550A) (formerly 852)	9.45	2
11853	Rack Mounting Assembly (525A)	23.11	10
KS-12000	Microphone Cover (639)	3.00	0.5
12495	Cabinet (436C, 438C)	27.00	6
12666	Microphone Case (upper, 639)	34.00	2
12862	VU Meter Assembly (1567A)	27.00	1
12863	XL Connector Assembly (1567A)	27.00	1
12864	Phono Equalizer (1567A)	5.25	1
12866	Portable Carrying Case	50.00	10
13033	Phono Adapter (1566A, 1561A)	7.50	1
13225	Rack Mounting Assembly (458A, 459A)	19.50	5
13387	Apparatus Unit (250 SU)	32.00	1
13401	Tray (458A, 459A)	4.50	1
14404	Cover (360B)	9.00	5
14678A	Compressor Assembly (361A)	60.00	2
14722	Bracket (361A)	4.85	1
15036	Repeat Coil	45.00	2
15064	70 Volt Transformer (1 watt)	8.25	1
15065	70 Volt Transformer (8 watt)	13.00	3
15074	70 Volt Transformer (4 watt)	8.60	1
15075A	70 Volt Transformer (15 watt)	7.50	4
15095	Line Transformer	12.00	1
15132	70 Volt Transformer (4 watt)	4.20	1
16660	70 Volt Transformer (361A)	10.50	2
50057	Connector Cover (9550)	3.15	1

ATTENUATORS, EQUALIZERS,
FILTERS, SWITCHES



Features:

- Up to 12 db High- and Low-Frequency Equalization
- Down to -16 db High- and Low-Frequency Attenuation
- Precision-Calibrated in 2 db steps
- Wide Range over Entire Audio Spectrum
- Vertical Slider Controls for Greater Accuracy — Easiest Reading
- Compensation for Wide Variations in Microphone/Ambient Characteristics
- Passive Circuit Elements — No Power Required
- Plug-In Connections to Mounting Frame
- May be Inserted Directly in Audio Line
- Miniature Size — Readily Installed
- Quietness of Operation
- Long-Term Stability

PROFESSIONAL RECORDING, BROADCAST AND REMOTE CONTROLS — PUBLIC ADDRESS AND SOUND REINFORCEMENT SYSTEMS — MOTION PICTURES

Multi-channel recording allows the audio engineer to select the particular microphone which provides an optimum response and pickup pattern for each of a variety of soloists, ensembles or acoustic environments. This procedure of using different types of microphones for recording a single master, however, may produce an uneven overall response in the finished product. The Altec 60A Microphone Equalizer is designed to correct the variations in response which occur under these circumstances, and to compensate for variations in apparent frequency response caused by changes in the microphone-to-subject distance, and for acoustical characteristics of the recording area (indoor or outdoor, 'dead' room or 'live' room, etc.)

In remote and 'on location' broadcast and sound recording applications, the continuously variable low and high frequency controls of the 60A make possible immediate attenuation of many ambient disturbances with minimal effect on the program material. In high-quality sound reinforcement usage, the 60A is exceptionally valuable in reducing low-frequency signal pickup, thereby minimizing acoustic feedback from this source.

The compact 'plug-in' design and precision sliding lever controls facilitates installation of the 60A in virtually any type of fixed or mobile mixer console. The passive L/C/R bridged 'T' network circuit requires no power supply and introduces no distortion. The 60A may be inserted directly into a 600 ohm transmission line at any point where the maximum/minimum input levels are satisfied.

The positive operation, small size, extreme quietness of operation and wide range make the Altec 60A Microphone Equalizer the ideal choice for the finest microphone compensation in all professional sound applications.



A Division of *LPV* Ling Altec, Inc.

1515 S. Manchester Ave., Anaheim, Calif.
New York

RECORDING &

BROADCASTING

EQUIPMENT

ALTEC 60A

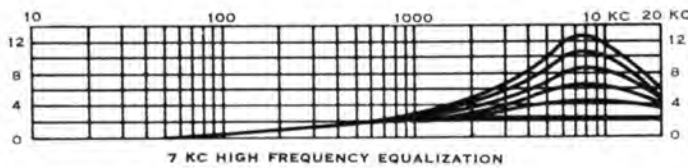
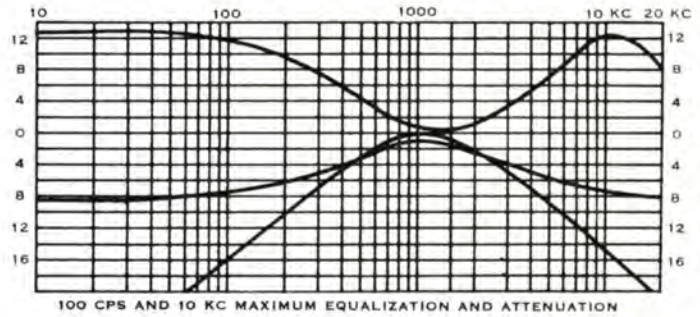
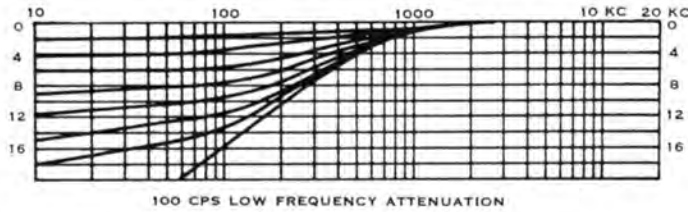
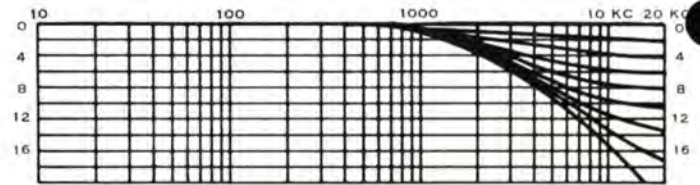
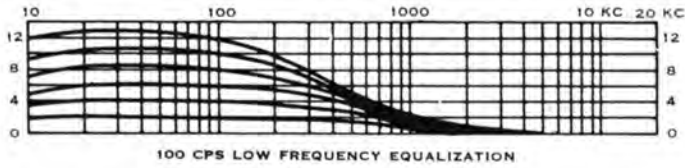

SPECIFICATIONS

Circuit: Passive L/C/R Bridged 'T', Constant 'K'
Impedance: Input — 600 ohms
 Output — 600 ohms
Insertion Loss: 14 db (with controls at '0')
Calibration: 2 db steps
Equalization: HF: Maximum +12 db at 7 kc; Minimum -16 db at 10 kc
 LF: Maximum +12 db at 100 cps; Minimum -16 db at 100 cps

Input Level: Minimum: -70 dbm to
 Maximum +20 dbm
Controls: 2 vertical slider type, silent operation
Connections: Plug-in mounting
Power Requirements: None
Distortion: None
Dimensions: 3 1/2" H x 1 1/2" W x 5 1/2" D
Weight: 1 lb. 12 oz.
Finish: Black anodized escutcheon with bright nickel hardware

DIMENSIONAL INFORMATION

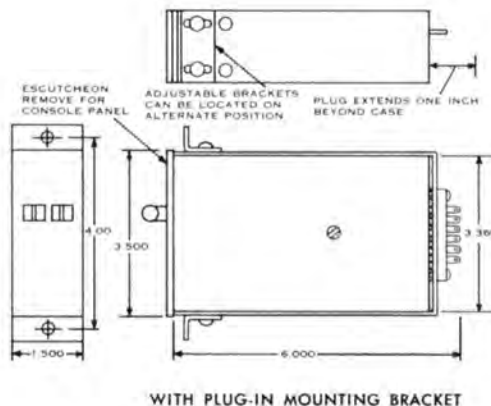
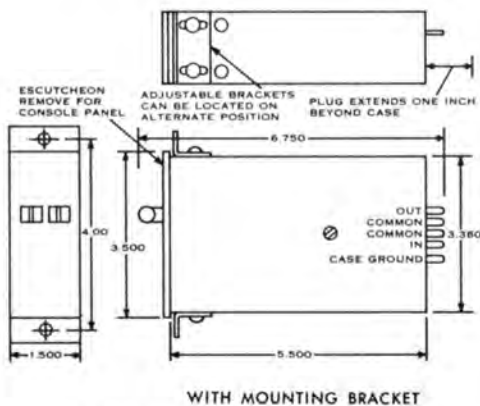

PRINTED IN U.S.A. 4/65

NOTICE
 We recommend that you obtain your Altec products from factory trained authorized Altec Sound Contractors and Distributors. This will assure you of proper installation, a continuing source of knowledgeable advice, service, and quick warranty protection.

61A and 63A Program Equalizers

61A

63A



Features:

Continuously Variable Low and High Frequency Equalization

Selectable Equalization Points

Up to 12 db Boost at 40 & 100 Cycles

16 db Attenuation at 100 Cycles

Up to 12 db Boost at 3, 5, 10, or 15 KC (16 db Attenuation at 10 KC)

Silent Operation

Passive Circuitry — Negligible Noise Level — No Distortion

Switchable "LF-HF-In-Out" Positions

Standard Rack Mounting

DISC, TAPE AND MOTION PICTURE RECORDING AND RE-RECORDING — NETWORK RADIO RELAY STATIONS — SOUND SYSTEMS IN HIGH-REVERBERATION AREAS — BROADCAST TRANSMISSION

The Altec 61A and 63A Program Equalizers provide for continuously variable equalization at selectable low- and high-frequencies for sound recording and transmission. Such equalization allows corrections to be made for the limitations of electro-mechanical equipment, reduces low frequency rumble, allows corrections to be made for the limitations of electro-mechanical equipment and permits the creation of the proper sonic 'illusions' necessary for the completed master or transmission to duplicate the frequency range and dynamic qualities of the original performance. In network relay or remote pickups where losses occur in the frequency spectrum, they may be corrected by use of the Program Equalizer. In public address or sound reinforcement usage, acoustic characteristics of the listening area may be compensated.

These Altec Program Equalizers provide continuously variable equalization at six important frequencies: at 40 or 100 cycles in the low frequency range, and — in the high frequency area — at 3, 5, 10 or 15 kc; and with calibrated attenuation frequency fixed at 10 kc. The relative amplitude of the high and low frequency peak is selected by individual controls which permit a maximum boost of +12 db and a maximum attenuation of -16 db. Roll-off remains at 100 cycles and 10 kc regardless of the setting of the frequency selector switches. Both equalizers incorporate a passive network so that no distortion is introduced into the system, nor is any external power source required.

The Altec 61A Program Equalizer includes a mounting frame which, once installed in the console, permits the unit to be plugged in or removed as desired. The 61A features two slider-type controls for ease of operation and greater accuracy. The unit measures 3½" H x 1½" W x 5½" D, and weighs only 1 lb. 12 oz.

The Altec 63A Program Equalizer, identical in circuitry to the 61A, is designed for standard 19" rack mounting for those installations where space limitations are not a problem. The Altec 63A has rear-mounted input and output terminals normaled through front panel jacks and features rotary switches instead of slider controls. It measures 3½" H x 19" W x 5¼" D, and weighs 12 lbs.



A Division of LTV Ling Altec, Inc.

1515 S. Manchester Ave., Anaheim, Calif.
New York

ALTEC 61A and 63A

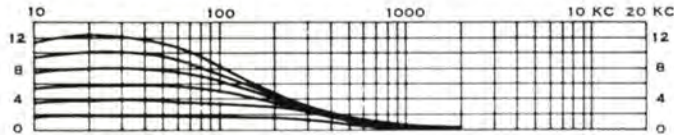

40 CPS LOW FREQUENCY EQUALIZATION

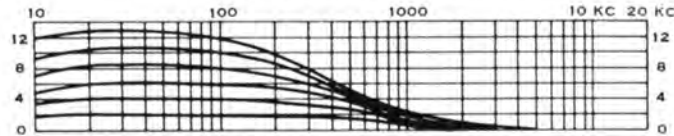

100 CPS LOW FREQUENCY EQUALIZATION

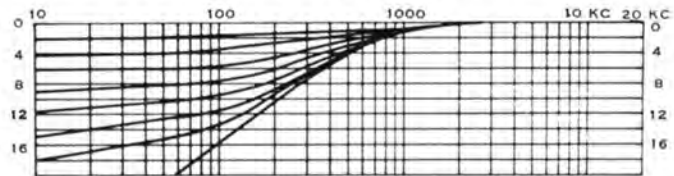

100 CPS LOW FREQUENCY ATTENUATION

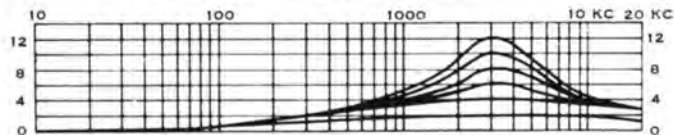

3 KC HIGH FREQUENCY EQUALIZATION

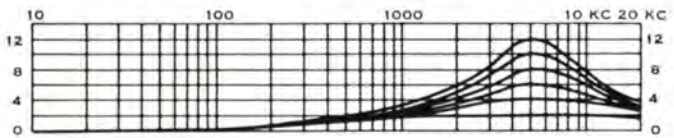

5 KC HIGH FREQUENCY EQUALIZATION

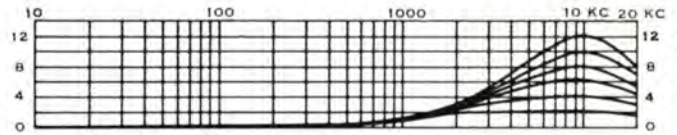

10 KC HIGH FREQUENCY EQUALIZATION

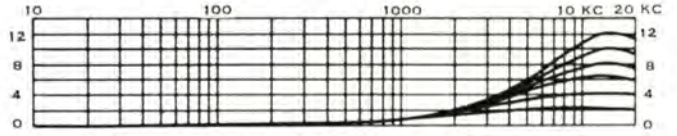

15 KC HIGH FREQUENCY EQUALIZATION

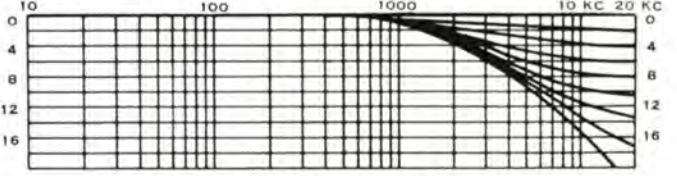

10 KC HIGH FREQUENCY ATTENUATION

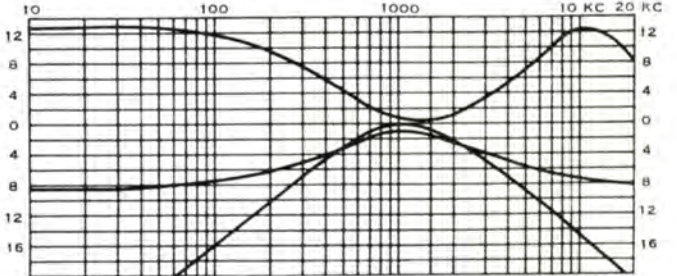

100 CPS AND 10 KC MAXIMUM EQUALIZATION AND ATTENUATION

SPECIFICATIONS

Circuit:	Bridged 'T', Constant 'K'
Impedance:	Input — 600 ohms Output — 600 ohms
Insertion Loss:	14 db (with controls at '0')
Input Level:	-70 dbm minimum to +20 dbm maximum
Power Requirements:	None
Distortion:	None

Controls:

61A
2 vertical slider type, adjustable in 2 db steps at (LF) 40 or 100 cycles (HF) 3, 5, 10 or 15 kc

63A
4—HF Rotary Equalizer
LF Rotary Equalizer
HF Frequency Selector
Equalizer 'In-Out' Selector

Connections:

61A
"Plug-in" unit

63A
Rack mounted, with rear terminals normaled with front panel input and output jacks.

DIMENSIONAL INFORMATION

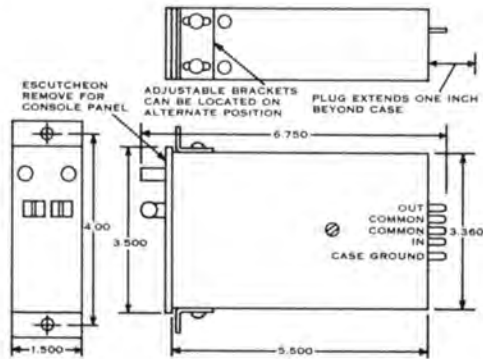

WITH MOUNTING BRACKET

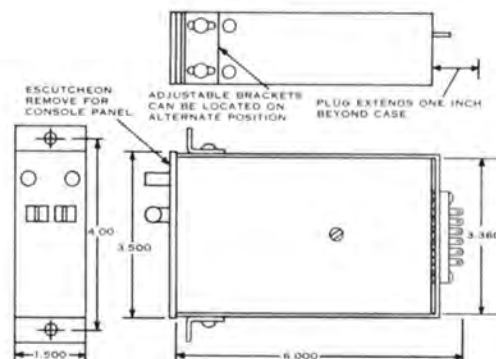

WITH PLUG-IN MOUNTING BRACKET

NOTICE
 We recommend that you obtain your Altec products from factory trained authorized Altec Sound Contractors and Distributors. This will assure you of proper installation, a continuing source of knowledgeable advice, service, and quick warranty protection.

62A, 72A, 73A, 74A Graphic Equalizers

62A
72A
73A
74A



Features:

Selected Frequencies of
Variable High and Low
Equalization and Attenuation

Passive Circuit Elements

Calibrated in 1 db Steps

Controlled Selectivity

Smooth, Noiseless Vertical
Slide Fingertip Controls

Plug-In Filter Units

Dirt and Lint Barrier

Gold Plated Glass Epoxy
Etched Circuit Boards

Readily Installed

Long Term Stability

No Maintenance

TAPE, DISC AND MOTION PICTURE SOUND RE-RECORDING SOUND REINFORCEMENT FOR THEATRES AND CONCERT HALLS NETWORK BROADCAST AND TELECAST TRANSMISSION

Sound recording often requires a means of immediate equalization simultaneously at various important points within the audio spectrum. Such equalization often is employed to accentuate a vocal or instrumental soloist or group, to compensate for high-frequency loss, to reduce peaks caused by unwanted mechanical resonances, or to change the overall frequency curve.

For broadcast use, multi-frequency equalization provides accurate control of remote and network transmissions which, otherwise, would suffer greatly from an improper overall response because of transmission line limitations. For public address and sound reinforcement use, the multi-frequency equalizer may accentuate certain frequencies for best intelligibility while simultaneously reducing other frequencies to prevent acoustic feedback or 'muddiness' of the reproduced sound.

The Altec 62A, 72A, 73A and 74A Graphic Equalizers have completely passive circuitry which induces no hum or distortion at levels from -70 to +24 dbm. The compact design permits installation of either unit in virtually all types of fixed and mobile consoles.

The Altec 62A and 72A units provide the engineer with quiet, positive, variable boost or attenuation — in steps of 1 db — at seven critical frequencies. The 73A and 74A units will boost or attenuate six different frequencies of +8 or -8 db in 1 db steps. The precise slider controls, having an accuracy of ± 0.5 db for each step, enable a frequency overlap which produces an essentially flat response when all controls are positioned in a straight line at any position of boost or attenuation. A new and improved brush design features dual contacts on each brush, and each brush is a gold-tipped bifurcated contact.

The 62A Graphic Equalizer measures $3\frac{1}{2}'' \times 10'' \times 5\frac{1}{4}''$ and has adjustable side-mount brackets for flush, recessed or protruding mounting. The 72A Graphic Equalizer is identical to the 62A except that it is designed for rack mounting and measures $3\frac{1}{2}'' \times 19'' \times 5\frac{1}{4}''$ deep. The rack mounting 72A and 74A have input and output jacks. The 73A measures $3\frac{1}{2}'' \times 8\frac{3}{4}'' \times 5\frac{1}{4}''$, and the 74A, identical to the 73A except that it is designed for rack mounting, measures $3\frac{1}{2}'' \times 19'' \times 5\frac{1}{4}''$ deep.



A Division of *LSV* Ling Altec, Inc.

1515 S. Manchester Ave., Anaheim, Calif.
New York

RECORDING &

BROADCASTING

EQUIPMENT

ALTEC 62A, 72A, 73A, 74A

62A and 72A Equalization Chart

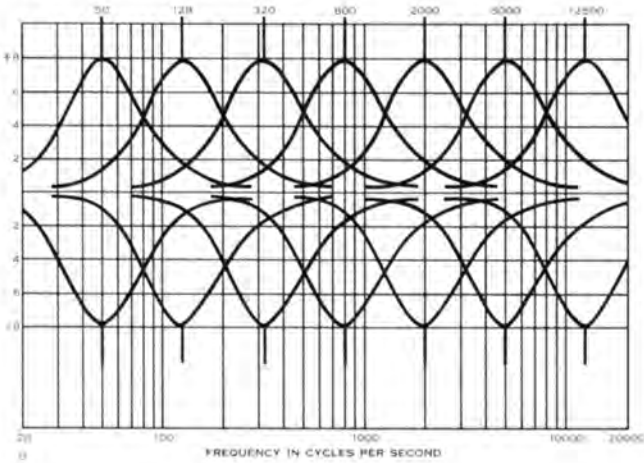

73A and 74A Equalization Chart

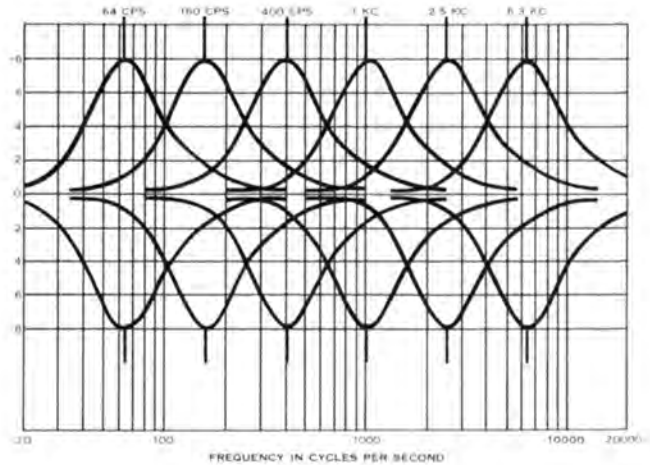

SPECIFICATIONS

Circuit:	Bridged 'T', Constant 'K'
Input and Output Impedances:	600 ohms
Insertion Loss:	16 db (with all controls at '0')
Operating Level:	-70 to +24 dbm
Controls:	<p>62A and 72A Seven — each providing from -8 db to +8 db of equalization at frequencies of: 50, 130, 320, 800, 2000, 5000, and 12,500 cps.</p> <p>73A and 74A Six — each providing from -8 db to +8 db of equalization at frequencies of: 64, 160, 400, 1000, 2500, and 6300 cps.</p>
Calibration:	16 steps of 1 db for each control
Accuracy:	±0.5 db at all steps
Distortion:	None
Hum and Noise Level:	None
Power Requirements:	None
Terminals:	Turret lugs
Finish:	<p>62A and 73A Black anodized escutcheon with bright nickled hardware</p> <p>72A and 74A Altec green</p>
Connections: (72A and 74A)	Rear-mounted input and output terminals normaled through with front panel jacks allow units to be permanently connected or patched in and out of the circuit with standard patch plugs and cables.

NOTICE
We recommend that you obtain your Altec products from factory trained authorized Altec Sound Contractors and Distributors. This will assure you of proper installation, a continuing source of knowledgeable advice, service, and quick warranty protection.

64A, 65A, 66A and 71A Fixed Filters and Attenuators

64A
65A
66A
71A

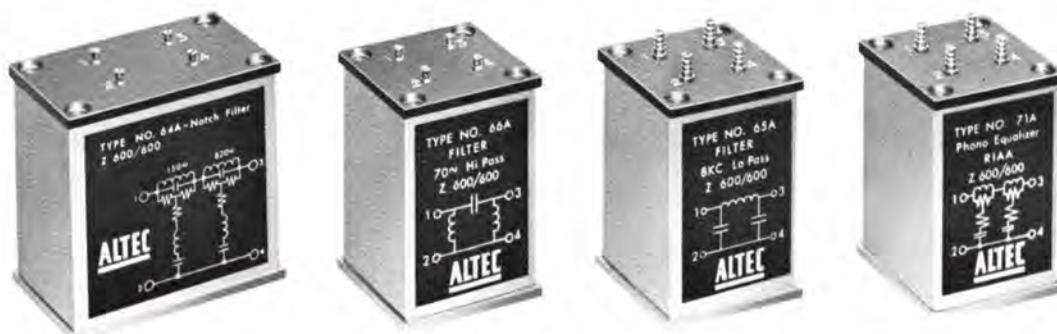

Features:

- Customer-Selected
Cut-Off Point
- Constant "K" Networks
- Zero Insertion Loss
- Either 18 or 30 db Per Octave
Attenuation Rate
- High Maximum Attenuation
- No Ringing
- Compact Design
- Easily Mounted
- No Maintenance
- No Power Required
- 71A Meets NARTB, AES,
and RIAA Requirements

PROFESSIONAL RECORDING, BROADCAST AND TELEVISION STUDIOS — PUBLIC ADDRESS AND SOUND REINFORCEMENT SYSTEMS — MOTION PICTURES

These Altec units are efficient, accurate and compact. They utilize passive, constant 'K' circuits which require no power and permit no distortion, and they have input and output impedances of 600 ohms. Use of toroidal coils assures minimum noise pick-up or hum, and permits the units to be mounted adjacent to other sound equipment operating at various levels without fear of the induction of extraneous noise.

The Altec 64A Notch Filter eliminates unwanted narrow band frequencies. Undesirable sounds such as camera noise, generator drone, arc-light sputter, air conditioner rumble, etc., may be reduced in recorded material with virtually no effect on the program material. Because the specific frequency of undesirable disturbances varies, the 64A is custom made to specifications submitted by the customer. The unit is available as a single or dual notch filter which attenuates two different frequencies, eliminating the need for two separate units. Notch frequencies may be ordered from 50 to 20,000 cps. The 64A will accept input levels from -70 to +24 dbm. It measures 2" x 3" x 2¹⁵/₁₆", and weighs approximately 12 ounces for the single notch filter; 1 pound for the dual notch unit.

The Altec 65A and 66A Filters provide attenuation at a fixed rate of 18 db per octave from a selected cut-off point. (Upon request, 30 db per octave units are available.) Since insertion loss, internal noise, and 'ringing' are not present, these filters are ideal for installation anywhere in transmission lines where input level varies from -70 to +24 db. For PA and sound reinforcement systems, these filters will prove useful in eliminating or reducing unwanted signals or noise that could deteriorate the program material. The 65A Low Pass Filter may be ordered to any specified cut-off point from 50 to 20,000 cps, and is exceptionally valuable in reducing acoustic feedback, high-frequency 'chirps', etc. The 66A High Pass Filter will eliminate or reduce unwanted low frequency signals or noises below a selected cut-off point (from 40 to 20,000 cps) preventing overmodulation, lack of intelligibility, etc. Both filters weigh 10 ounces each and measure 1¹⁵/₁₆" x 1¹⁵/₁₆" x 2¹⁵/₁₆".

The Altec 71A RIAA Equalizer is designed for transcription pickups to obtain the proper RIAA playback characteristics from disc masters. The 71A has an input level from -70 to +24 db, and an insertion loss of 20 db at 1000 cps. The unit weighs only 14 ounces and measures 1¹⁵/₁₆" x 1¹⁵/₁₆" x 2¹⁵/₁₆".



A Division of *LSPV* Ling Altec, Inc.

1515 S. Manchester Ave., Anaheim, Calif.
New York

RECORDING &

BROADCASTING

EQUIPMENT

ALTEC 64A, 65A, 66A and 71A

64A SINGLE NOTCH FILTER

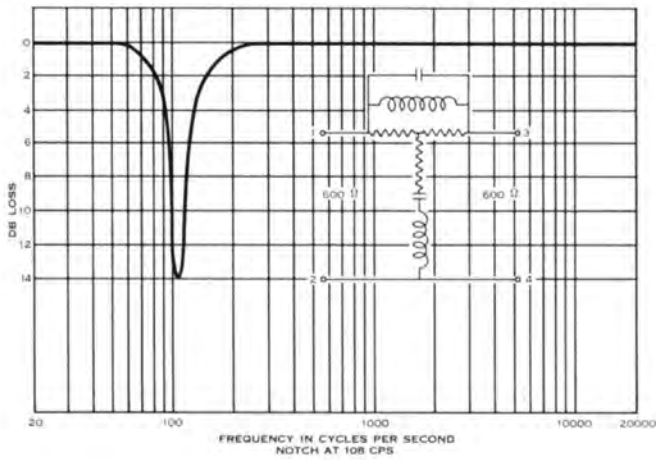

64A DUAL NOTCH FILTER

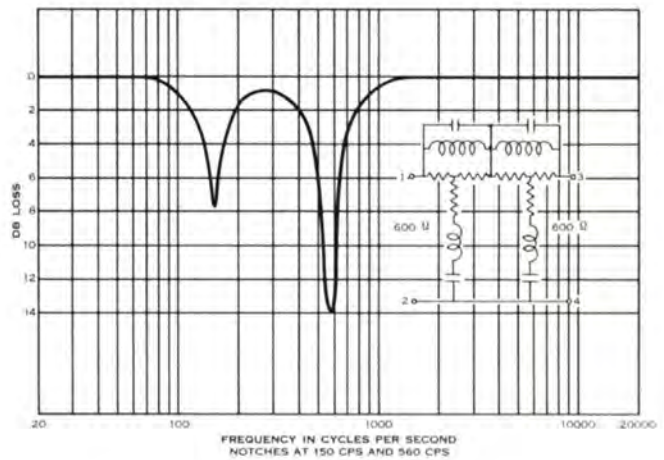

65A FIXED LOW PASS FILTER

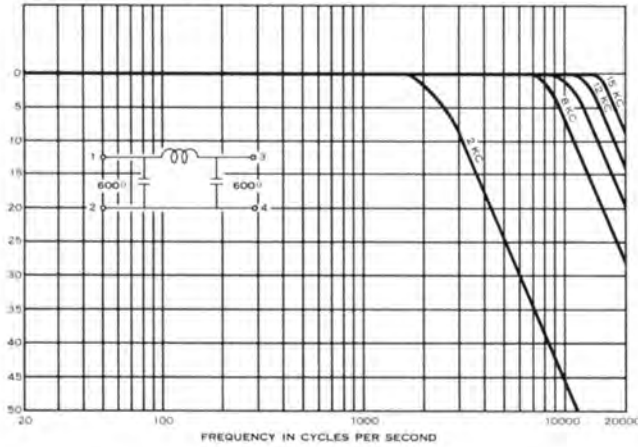

66A FIXED HIGH PASS FILTER

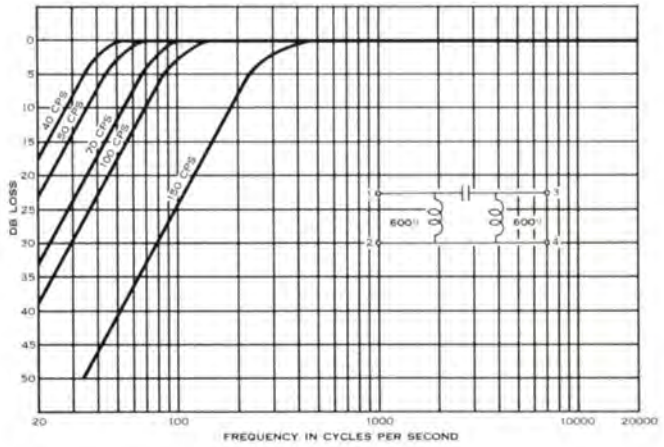

RIAA CURVE

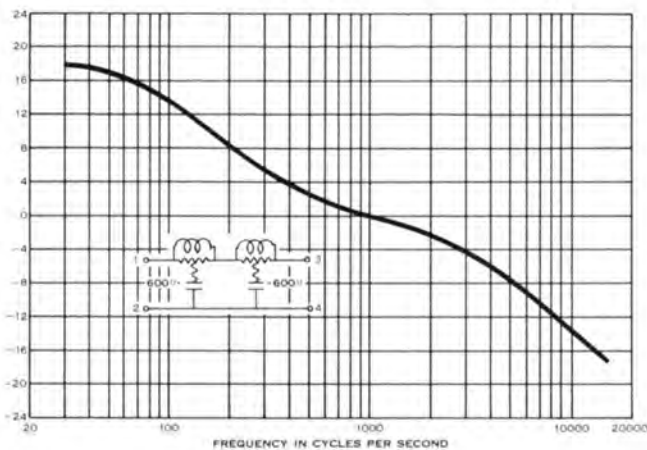

SPECIFICATIONS

Circuit:	Passive, constant 'K'
Impedance:	Input — 600 ohms Output — 600 ohms
Insertion Loss:	None (20 db at 1000 cps on 71A)
Power Required:	None
Mounting:	4 holes on 1 1/2 centers for 6-32 machine screws
Notches	64A —optional from 20 to 20,000 cps
Cut-Off Frequency:	65A —optional from 50 to 20,000 cps 66A —optional from 40 to 20,000 cps
Input Level:	64A & 71A —70 minimum to +24 maximum 65A & 66A —70 minimum to +28 maximum
Attenuation Rate:	65A & 66A 18 db per octave (30 db per octave available on request)
Ordering Information:	On 64A, 65A & 66A specify model number and notch or cut-off frequency desired when ordering.

NOTICE
We recommend that you obtain your Altec products from factory trained authorized Altec Sound Contractors and Distributors. This will assure you of proper installation, a continuing source of knowledgeable advice, service, and quick warranty protection.

9067A, 9068A, and 9069A

(FORMERLY 67A, 68A, 69A)

Variable High and Low Pass Filters

9067A
9068A
9069A



9067A VARIABLE
HIGH AND LOW PASS FILTER



9069A HIGH PASS FILTER



9068A LOW PASS FILTER

Features:

- 10 Positions of LF and HF Cutoff
- 18 db per Octave Attenuation at Any Selected Frequency
- Zero Insertion Loss
- Completely Silent Control Action
- Immediate Selection of Either or Both Filters into Circuit
- No Hum Pickup — Even in Low-Level Circuitry
- No Distortion
- Standard Rack Mounting

FOR PROFESSIONAL USE
DISC, TAPE AND FILM RECORDING — BROADCAST
AND TELECAST STUDIOS — "SOUND EFFECTS" —
MOTION PICTURE SOUND STAGES — "SPECIAL EFFECTS"
PUBLIC ADDRESS AND SOUND REINFORCEMENT SYSTEMS

These Altec variable filters are ideal for all phases of broadcasting, recording and reproduction of sound. As 'sound effects' or 'special effects' components, they are unsurpassed. The wide variety of effects possible—coupled with the simplicity and ease of operation—make these filters a necessity for professional audio applications wherever accurate control of the audio spectrum is required.

Incorporating both the 9068A and the 9069A, the Altec 9067A Variable Low Pass and High Pass Filter affords complete flexibility in one compact unit. The entire filter may be switched in and out of the transmission line instantly, or—if desired—either or both sections may be switched individually. The low frequency control provides 10 cut-off characteristics: at 70, 100, 150, 250, 500, 1000, 2000, 3000, 5000 and 7500 cycles. An equal number are available with the high frequency control at 250, 500, 1000, 2000, 3000, 4000, 5000, 6000, 8000, and 10,000 cycles. Regardless of the selected cut-off frequency, the attenuation rate remains constant at 18 db per octave. Both controls have an 'off' position which allows the full frequency range of the program material to be transmitted. The silent action of positive detents allows frequency cut-off changes to be made during actual sound processing.

All inductances employed are toroidally wound, permitting the unit to be used in extremely low-level circuitry without noise or hum pick-up. The zero insertion loss facilitates the connection of these units to any point in the transmission line (having a level from -70 to +28 dbm) without the need for external power supplies or additional amplification stages.

The Altec 9067A is totally enclosed with rear-mounted input and output terminals normaled through front panel jacks. It measures only 3½" high by 19" wide and is 5¼" deep, and weighs 15 pounds.

The Altec 9068A Variable Low Pass Filter and the Altec 9069A Variable High Pass Filter are electrically identical to the filters incorporated within the Altec 9067A, but are furnished as individual units for custom mounting. Four 1¼ inch mounting centers are provided on the front panel of these units. They measure 2¼" W x 3" H x 5½" D, and weigh 2 pounds each.



A Division of LTV Ling Altec, Inc.

1515 S. Manchester Ave., Anaheim, Calif.
New York

RECORDING &

BROADCASTING

EQUIPMENT

ALTEC 9067A, 9068A, 9069A

RESPONSE CHARACTERISTICS

9067A (High Pass Section) and 9069A

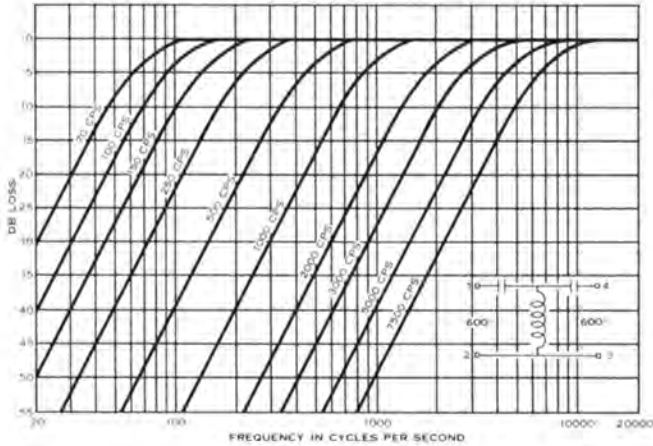

9067A (Low Pass Section) and 9068A

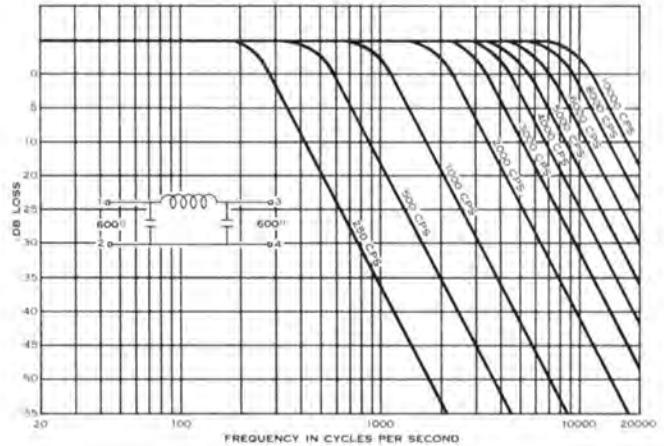

SPECIFICATIONS

Circuit:	Bridged 'T', constant 'K'
Impedance:	Input — 600 ohms Output — 600 ohms
Insertion Loss:	None
Phase Distortion:	None
Input Level:	+24 dbm maximum -70 dbm minimum
Cut-Off Frequencies:	(LF) 70, 100, 150, 250, 500, 1000, 2000, 3000, 5000, and 7500 cycles. (HF) 250, 500, 1000, 2000, 3000, 4000, 5000, 6000, 8000, and 10,000 cycles.
Attenuation:	18 db per octave
Power Requirements:	None
Connections: (9067A)	Rear-mounted input and output terminals normaled through with front panel jacks allow units to be permanently connected or patched in and out of the circuit with standard patch plugs and cables.

DIMENSIONAL INFORMATION

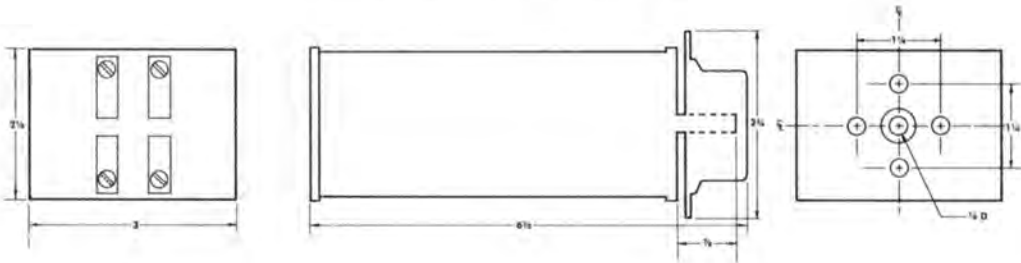

NOTICE
We recommend that you obtain your Altec products from factory trained authorized Altec Sound Contractors and Distributors. This will assure you of proper installation, a continuing source of knowledgeable advice, service, and quick warranty protection.

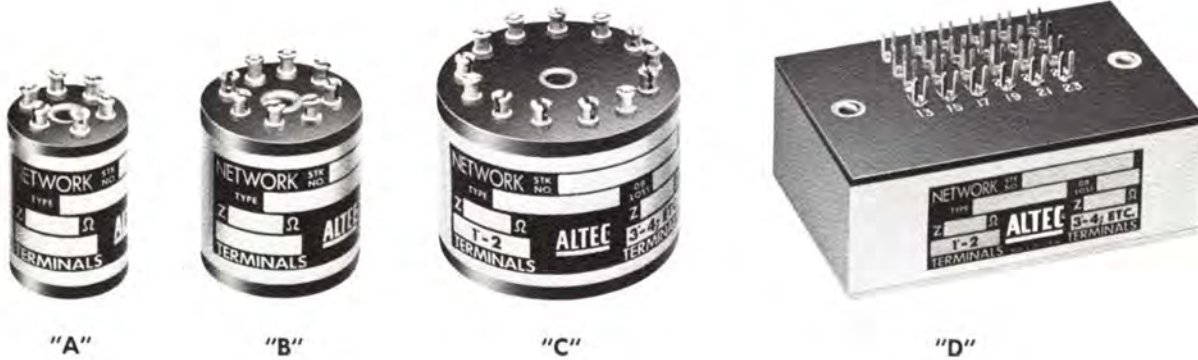

Features:

Precision Components in
Totally Enclosed Cases

Unbalanced "T" or
Balanced "H" Circuits

Mixer Networks
with Up to 20 Inputs
(More on Special Order)

Available in Wide
Range of Impedances

Special Units Designed to
Customer Specifications

Dust and Dirt Protected

Lightweight

Easily Mounted

DISC, TAPE AND FILM RECORDING — AM AND FM BROADCASTING TELEVISION AND MOTION PICTURE STUDIOS SOUND LABORATORIES — BROADCAST AND TELECAST TRANSMISSION

Precision networks are essential tools of the audio engineer who cannot tolerate any compromises in his sound equipment. Altec has designed a special line of precision networks; mixers, matching pads, fixed loss pads, bridging pads, VU meter extenders — in unbalanced "T" and balanced "H" configurations — 'instock' in the commonly used values, or custom made for special applications. These precision networks introduce no frequency discrimination or distortion from 0 to 150 kilocycles. The extreme care used in every detail, together with many years of experience designing and producing the highest quality audio equipment, assures the professional engineer that he is using the finest components available.

Altec Precision Networks are made in four case sizes, totally enclosed for dust and dirt protection, and are equipped with solder terminals for permanent installation. The four case sizes are illustrated in Figure 3 together with dimensional information. The cases are made of anodized aluminum with a black bakelite mounting block for the terminals. Mounting holes are provided in the case (two in the larger D size, one each in the A, B, and C size), and extend through the case allowing the network to be bolted in position.

MODEL	DESCRIPTION	CASE SIZE
8000	Mixer Network — unbalanced circuit	A, B, C, or D
8001	Mixer Network — balanced circuit	A, B, C, or D
8002	Minimum Loss Matching Pad — unbalanced "T" circuit	A
8003	Minimum Loss Matching Pad — balanced "H" circuit	A
8004	Fixed Loss Pad — unbalanced "T" circuit	A
8005	Fixed Loss Pad — balanced "H" circuit	A
8006	Adjustable T Pad — 0 to 40 db in 1 db steps — unbalanced "T"	C
8007	Adjustable H Pad — 0 to 40 db in 1 db steps — balanced "H"	D
8008	Bridging Pad — unbalanced "T" circuit	A
8009	Bridging Pad — balanced "H" circuit	A
8010	Adjustable VU Meter Extender — +4 to +35 VU in 1 db steps	C
8011	Fixed VU Meter Extender — from +4 to +40, as specified	A
8012	Adjustable T Pad — 0 to 63 db in 1 db steps, unbalanced "T"	C
8013	Adjustable H Pad — 0 to 63 db in 1 db steps, balanced "H"	D



A Division of BSW Ling Altec, Inc.

1515 S. Manchester Ave., Anaheim, Calif.
New York

8000 MIXER NETWORK — Unbalanced

8001 MIXER NETWORK — Balanced

Mixer networks allow a number of input signals to be paralleled and match the desired line impedance. The Altec series of mixer networks will handle any number of mixer branches, up to 20, (more on special order), and are available in both the unbalanced (8000 series) or the balanced (8001 series) configuration. These mixers will sustain steady sine wave tones up to a level of +30 dbm. (1 watt). Designed for standard impedances of 600 or 150 ohms, these mixers are also available (to the customer's specifications) for those situations where line inputs of several different impedances must be mixed, or where the input impedance is different from the output. To order: Specify by model number; for example, 8000-2 is an unbalanced mixer with two inputs — model 8001-8 is a balanced mixer with eight inputs.

Model Number*	Number of Inputs	DB Loss	Case Size	Model Number*	Number of Inputs	DB Loss	Case Size
8000-2	2	6	A	8000-12	12	21.6	D
8000-3	3	9.5	B	8000-13	13	22.3	
8000-4	4	12	C	8000-14	14	22.9	
8000-5	5	14		8000-15	15	23.5	
8000-6	6	15.6	D	8000-16	16	24.1	
8000-7	7	16.9		8000-17	17	24.6	
8000-8	8	18.1		8000-18	18	25.1	
8000-9	9	19.1		8000-19	19	25.6	
8000-10	10	20		8000-20	20	26.0	
8000-11	11	20.8					

*Model numbers shown are for unbalanced circuits. Use 8001 for balanced circuits.

Table 1

NETWORKS ARE REVERSIBLE

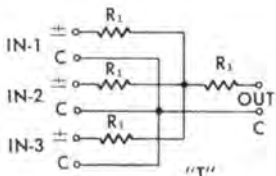

MODEL 8000

$$\frac{N-1}{N+1} Z = R_1$$

$$\frac{N+1}{N-1} Z = R_1$$

Where

N = number of inputs

Z = impedance in ohms

R = resistance in ohms

(Applies only to equal input and output impedances)

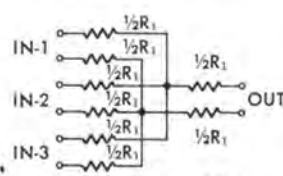

BALANCED

MODEL 8001

Figure 1

8002 MINIMUM LOSS MATCHING PAD — Unbalanced

8003 MINIMUM LOSS MATCHING PAD — Balanced

The Altec 8002 and 8003 Minimum Loss Matching Pads are designed for the exact matching of frequently used line impedances. The combinations and the amount of loss in db is shown in Table 2. The schematics are illustrated in Figure 2. To order: Specify the model number, the input impedance and the output impedance desired, for example; 8003-600-50 is a balanced pad with an input impedance of 600 ohms and an output impedance of 50 ohms. This will provide a minimum loss of 16.63 db and assure an impedance match of the 600 ohm input and the 50 ohm output of the matching pad.

Input Impedance	Output Impedance							
	30	50	125	150	200	250	500	600
600	18.92	16.63	12.33	11.43	9.95	8.73	3.76	0
500	18.11	15.79	11.43	10.52	8.96	7.65	0	3.76
250	14.95	12.54	7.65	6.47	4.18	0	7.65	8.73
200	13.91	11.44	6.19	4.74	0	4.18	8.96	9.95
150	12.53	8.93	3.76	0	4.74	6.47	10.52	11.43
125	11.63	8.97	0	3.76	6.19	7.65	11.43	12.33
50	6.47	0	8.97	9.96	11.44	12.54	15.79	16.63
30	0	6.47	11.63	12.53	13.91	14.95	18.11	18.92

Altec 8002 and 8003 Minimum Loss Matching Pads — Input Impedance versus Output Impedance — Loss in DB

Table 2

Losses greater than minimum loss specified in Table 2 are available on special order. For example: Minimum loss specified for the 150 to 600 ohm pad is 11.43 db, losses of 15, 20, etc., are available on special order.

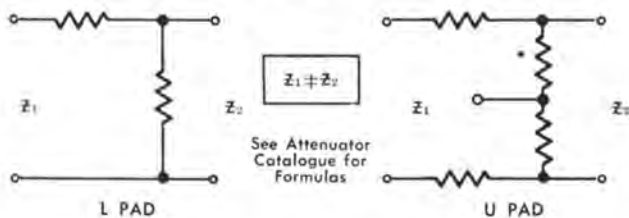

MODEL 8002

MODEL 8003

Figure 2

SPECIFICATIONS

Dimensions:

(including terminals)

Type A — 3/4" in diameter x 1 1/4" high
 Type B — 1" in diameter x 1 3/4" high
 Type C — 1 1/2" in diameter x 1 3/4" high
 Type D — 2" x 3" x 1 1/4"

Weight:

Type A — less than 1/2 oz.
 Type B — less than 1/2 oz.
 Type C — less than 1/2 oz.
 Type D — Approximately 3 oz.

DIMENSIONAL INFORMATION

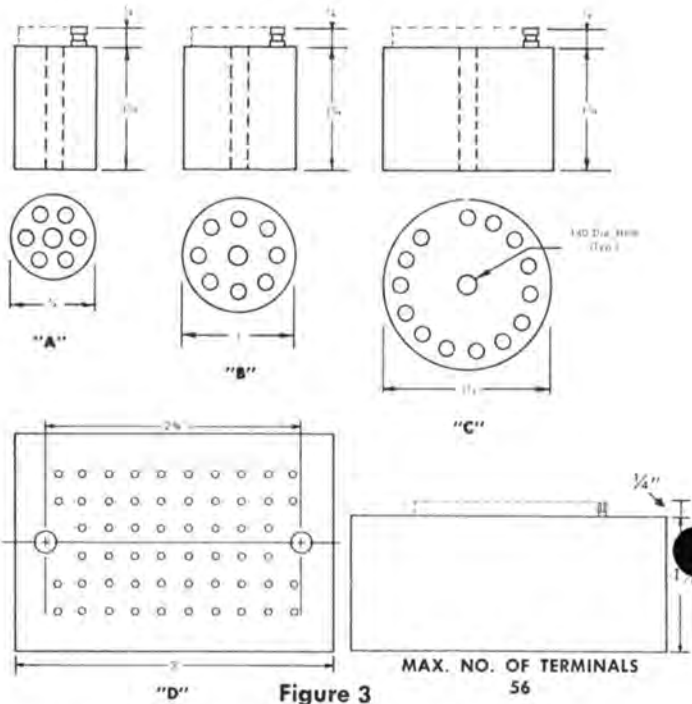

Figure 3

8004 FIXED LOSS PAD — Unbalanced

8005 FIXED LOSS PAD — Balanced

Occasionally the audio engineer may encounter a situation where an amplifier provides more gain than desired. To compensate for this condition, a Fixed Loss Pad may be employed which will protect the other equipment in the line from possible overload without adding any distortion to the signal or program material. In addition, a Fixed Loss Pad provides impedance stabilization between circuits assuring the engineer of proper impedance matching while preventing overload.

The Altec 8004 (unbalanced "T" circuit) and the 8005 (balanced "H" circuit) Fixed Loss Pads are available in any amount of loss up to 60 db, and have an impedance of 600 ohms. Other impedance values are available to customer specification, on request. Figure 4 illustrates the circuit configuration. To order: Specify the model number, amount of loss required and the impedance value. For example; 8004-30-600 would be an unbalanced pad using the "T" circuit with a loss of 30 db and an impedance of 600 ohms, a 8005-23-150 would be a balanced pad using the "H" circuit with a loss of 23 db and an impedance of 150 ohms.

See Attenuator Catalogue for Formulas



MODEL 8004

MODEL 8005

Figure 4

8006 FIXED LOSS PAD — Adjustable — Unbalanced
8007 FIXED LOSS PAD — Adjustable — Balanced

There are certain situations where the engineer may require a Fixed Loss Pad that must be changed in value from time to time. For this condition, the Altec 8006 in the unbalanced "T" circuit, and the Altec

8007 in the balanced "H" circuit has been provided. These Fixed Loss Pads permit selection, by strapping, of any loss up to 40 db in 1 db steps by utilizing combinations of 1, 2, 3, 4, 10 and 20 db. Table 3 illustrates the method used in accomplishing this and the circuits are diagrammed in Figure 5.

Input and Output Impedance = 600 Ω
 Maximum Power Level = +30 dbm (1 watt)

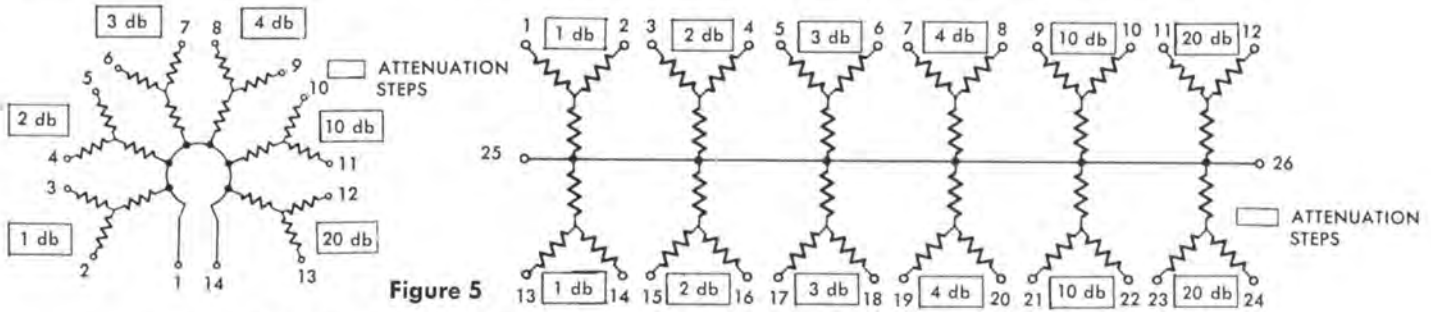

Figure 5

UNBALANCED "T," MODEL 8006

LOSS REQ'D	COMBINATION USED	STRAPPING	CONNECTIONS	
			INPUT	OUTPUT
1 db	None	None	1 & 2	3 & 14
2 db	None	None	1 & 4	5 & 14
3 db	None	None	1 & 6	7 & 14
4 db	None	None	1 & 8	9 & 14
5 db	2 db & 3 db	5-6	1 & 4	7 & 14
6 db	2 db & 4 db	5-8	1 & 4	9 & 14
7 db	3 db & 4 db	7-8	1 & 6	9 & 14
8 db	1, 3, & 4 db	3-4, 5-6, 7-8	1 & 2	9 & 14
9 db	2, 3, & 4 db	5-6, 7-8	1 & 4	9 & 14
10 db	None	None	1 & 10	11 & 14
11 db	10 & 1 db	3-10	1 & 2	11 & 14
12 db	10 & 2 db	5-10	1 & 4	11 & 14
13 db	10 & 3 db	7-10	1 & 6	11 & 14
14 db	10 & 4 db	9-10	1 & 8	11 & 14
15 db	10, 4 & 1 db	3-8, 9-10	1 & 2	11 & 14
16 db	10, 4 & 2 db	5-8, 9-10	1 & 4	11 & 14
17 db	10, 4 & 3 db	7-8, 9-10	1 & 6	11 & 14
18 db	10, 4, 3 & 1 db	3-6, 7-8, 9-10	1 & 2	11 & 14
19 db	10, 4, 3 & 2 db	5-6, 7-8, 9-10	1 & 4	11 & 14
20 db	None	None	1 & 12	13 & 14
21 db	20 & 1 db	3-12	1 & 2	13 & 14
22 db	20 & 2 db	5-12	1 & 4	13 & 14
23 db	20 & 3 db	7-12	1 & 6	13 & 14
24 db	20 & 4 db	9-12	1 & 8	13 & 14
25 db	20, 3, & 2 db	5-6, 7-12	1 & 4	13 & 14
26 db	20, 4 & 2 db	5-8, 9-12	1 & 4	13 & 14
27 db	20, 4 & 3 db	7-8, 9-12	1 & 6	13 & 14
28 db	20, 4, 3 & 1 db	3-6, 7-8, 9-12	1 & 2	13 & 14
29 db	20, 4, 3 & 2 db	5-6, 7-8, 9-12	1 & 4	13 & 14
30 db	20 & 10 db	11-12	1 & 10	13 & 14
31 db	20, 10 & 1 db	3-10, 11-12	1 & 2	13 & 14
32 db	20, 10 & 2 db	5-10, 11-12	1 & 4	13 & 14
33 db	20, 10 & 3 db	7-10, 11-12	1 & 6	13 & 14
34 db	20, 10 & 4 db	9-10, 11-12	1 & 8	13 & 14
35 db	20, 10, 3 & 2 db	5-6, 7-10, 11-12	1 & 4	13 & 14
36 db	20, 10, 4 & 2 db	5-8, 9-10, 11-12	1 & 4	13 & 14
37 db	20, 10, 4 & 3 db	7-8, 9-10, 11-12	1 & 6	13 & 14
38 db	20, 10, 4, 3 & 1 db	3-6, 7-8, 9-10, 11-12	1 & 2	13 & 14
39 db	20, 10, 4, 3 & 2 db	5-6, 7-8, 9-10, 11-12	1 & 4	13 & 14
40 db	20, 10, 4, 3, 2 & 1 db	3-4, 5-6, 7-8, 9-10, 11-12	1 & 2	13 & 14

Table 3

BALANCED "H," MODEL 8007

LOSS REQ'D	COMBINATION USED	STRAPPING	CONNECTIONS	
			INPUT	OUTPUT
1 db	None	None	1 & 13	2 & 14
2 db	None	None	3 & 15	4 & 16
3 db	None	None	5 & 17	6 & 18
4 db	None	None	7 & 19	8 & 20
5 db	2 & 3 db	4-5, 16-17	3 & 15	6 & 18
6 db	2 & 4 db	4-7, 16-19	3 & 15	8 & 20
7 db	3 & 4 db	6-7, 18-19	5 & 17	8 & 20
8 db	1, 3 & 4 db	2-5, 6-7, 14-17, 18-19	1 & 13	8 & 20
9 db	2, 3 & 4 db	4-5, 6-7, 16-17, 18-19	3 & 15	8 & 20
10 db	None	None	9 & 21	10 & 22
11 db	10 & 1 db	2-9, 14-21	1 & 13	10 & 22
12 db	10 & 2 db	4-9, 16-21	3 & 15	10 & 22
13 db	10 & 3 db	6-9, 18-21	5 & 17	10 & 22
14 db	10 & 4 db	8-9, 20-21	7 & 19	10 & 22
15 db	10, 3 & 2 db	4-5, 6-9, 16-17, 18-21	3 & 15	10 & 22
16 db	10, 4 & 2 db	4-7, 8-9, 16-19, 20-21	3 & 15	10 & 22
17 db	10, 4 & 3 db	6-7, 8-9, 18-19, 20-21 2-5, 6-7, 8-9, 14-17,	5 & 17	10 & 22
18 db	10, 4, 3 & 1 db	18-19, 20-21 4-5, 6-7, 8-9, 16-17,	1 & 13	10 & 22
19 db	10, 4, 3 & 2 db	18-19, 20-21	3 & 15	10 & 22
20 db	None	None	11 & 23	12 & 24
21 db	20 & 1 db	2-11, 14-23	1 & 13	12 & 24
22 db	20 & 2 db	4-11, 15-23	3 & 15	12 & 24
23 db	20 & 3 db	6-11, 16-23	5 & 17	12 & 24
24 db	20 & 4 db	8-11, 20-23	7 & 19	12 & 24
25 db	20, 3 & 2 db	4-5, 6-11, 16-17, 18-23	3 & 15	12 & 24
26 db	20, 4 & 2 db	4-7, 8-11, 16-19, 20-23	3 & 15	12 & 24
27 db	20, 4 & 3 db	6-7, 8-11, 18-19, 20-23 2-5, 6-7, 8-11, 14-17,	5 & 17	12 & 24
28 db	20, 4, 3 & 1 db	18-19, 20-23 4-5, 6-7, 8-11, 16-17,	1 & 13	12 & 24
29 db	20, 4, 3 & 2 db	18-19, 20-23	3 & 15	12 & 24
30 db	20 & 10 db	10-11, 22-23	9 & 21	12 & 24
31 db	20, 10 & 1 db	2-9, 10-11, 14-21, 22-23	1 & 13	12 & 24
32 db	20, 10 & 2 db	4-9, 10-11, 16-21, 22-23	3 & 15	12 & 24
33 db	20, 10 & 3 db	6-9, 10-11, 18-21, 22-23	5 & 17	12 & 24
34 db	20, 10 & 4 db	8-9, 10-11, 20-21, 22-23 4-5, 6-9, 10-11, 16-17,	7 & 19	12 & 24
35 db	20, 10, 3 & 2 db	18-21, 22-23 4-7, 8-9, 10-11, 16-19,	3 & 15	12 & 24
36 db	20, 10, 4 & 2 db	20-21, 22-23 6-7, 8-9, 10-11, 18-19,	3 & 15	12 & 24
37 db	20, 10, 4 & 3 db	20-21, 22-23 2-5, 6-7, 8-9, 10-11, 14-	5 & 17	12 & 24
38 db	20, 10, 4, 3 & 1 db	17, 18-19, 20-21, 22-23 4-5, 6-7, 8-9, 10-11, 16-	1 & 13	12 & 24
39 db	20, 10, 4, 3 & 2 db	17, 18-19, 20-21, 22-23 2-3, 4-5, 6-7, 8-9, 10-11,	3 & 15	12 & 24
40 db	20, 10, 4, 3, 2 & 1 db	14-15, 16-17, 18-19, 20-21, 22-23	1 & 13	12 & 24

Table 4

8008 BRIDGING PAD — Unbalanced "T"

8009 BRIDGING PAD — Balanced "H"

The Altec Bridging Pads are designed for those applications where a high impedance must be connected to a 600 ohm line output. These bridging pads are available in unbalanced or balanced configurations, models 8008 and 8009 respectively, and when ordering, specify the input and output impedance. To order: Specify by model number and impedance, for example; 8009-600-2000 would be a Bridging Pad with a balanced "H" circuit, 600 ohm input impedance and 2000 ohm output impedance. Figure 6 illustrates the circuit used in these pads.

For case size, see Table on front page.

See Pad Loss Table in Attenuator Catalogue to determine 'bridging' losses.

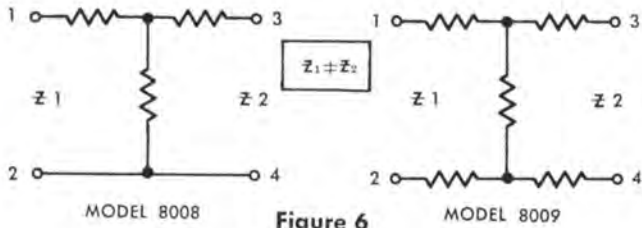

Figure 6

8010 VARIABLE VU METER EXTENDER

8011 FIXED VU METER EXTENDER

The VU Meter Extenders are designed for those conditions where line levels exceed the normal maximum input of the VU meter and a calibrated pad is desired to enable correct meter readings to be made. These pads insert a fixed loss in the VU meter circuit, permitting the range of the VU meter to be extended to cover the additional level.

These pads are designed to bridge 600 ohm lines and may be used in the 3900 ohm or 7500 ohm configuration. Figures 7 and 8 illustrates the circuits used in these pads.

To order: Specify the model number and in the case of the 8011 type, specify the size of the pad required, for example; the model 8011-15 is a Fixed VU Meter Extender in an "A" size case and when the input is connected across terminals 1 and 4, the meter will indicate 0 db for a true level of +15 dbm. The model 8010 is supplied in the "C" size case and must be strapped in accordance with Table 5 for the required meter readings.

Line Impedance Variation

When a VU meter is 'bridged' across a line that is not 600 ohms, the true line level in dbm will change. Some of the more commonly used line impedances are given in the following chart for reference:

Line Impedance	Meter Reading	Line Level in DBM	Watts at 70 Volts
4	0	+43.5	
8	0	+37.5	
16	0	+31.5	
19	0	+30.0	260
32	0	+25.5	175
50	0	+21.5	
62	0	+19.8	80
125	0	+13.5	40
150	0	+12.0	
200	0	+ 9.5	
250	0	+ 7.5	18
300	0	+ 6.0	
600	0	0	
1000	0	- 4.5	

**TABLE 5, STRAPPING FUNCTIONS FOR THE MODEL 8010 VARIABLE VU METER EXTENDER
LINE IMPEDANCE = 600 OHMS**

LINE LEVEL IN DB WHEN 0 VU IS DESIRED ON METER	STRAPPING		CONNECTIONS			
			INPUT		METER	
	7500 OHMS	3600 OHMS	7500 Ω	3600 Ω	7500 Ω	3600 Ω
1	None	4 & 1	5 & 14
2	None	6 & 1	7 & 14
3	5-6	4 & 1	7 & 14
4	None	None	2 & 1	8 & 1	3 & 14	9 & 14
5	3-4	5-8	2 & 1	4 & 1	5 & 14	9 & 14
6	3-6	7-8	2 & 1	6 & 1	7 & 14	9 & 14
7	3-4, 5-6	5-6, 7-8	1 & 2	4 & 1	7 & 14	9 & 14
8	3-8	None	1 & 2	8 & 1	9 & 14	11 & 14
9	3-4, 5-8	5-10	2 & 1	4 & 1	9 & 14	11 & 14
10	3-6, 7-8	7-10	2 & 1	6 & 1	9 & 14	11 & 14
11	3-4, 5-6, 7-8	5-6, 7-10	2 & 1	4 & 1	9 & 14	11 & 14
12	3-10	9-10	2 & 1	8 & 1	11 & 14	11 & 14
13	3-4, 5-10	5-8, 9-10	2 & 1	4 & 1	11 & 14	11 & 14
14	3-6, 7-10	7-8, 9-10	2 & 1	6 & 1	11 & 14	11 & 14
15	3-4, 5-6, 7-10	5-6, 7-8, 9-10	2 & 1	4 & 1	11 & 14	11 & 14
16	3-8, 9-10	None	2 & 1	12 & 14	11 & 14	13 & 14
17	3-4, 5-8, 9-10	5-12	2 & 1	4 & 1	11 & 14	13 & 14
18	3-6, 7-8, 9-10	7-12	2 & 1	6 & 1	11 & 14	13 & 14
19	3-4, 5-6, 7-8, 9-10	5-6, 7-12	2 & 1	4 & 1	11 & 14	13 & 14
20	3-12	9-12	2 & 1	8 & 1	13 & 14	13 & 14
21	3-4, 5-12	5-8, 9-12	2 & 1	4 & 1	13 & 14	13 & 14
22	3-6, 7-12	7-8, 9-12	2 & 1	6 & 1	13 & 14	13 & 14
23	3-4, 5-6, 7-12	5-6, 7-8, 9-12	2 & 1	4 & 1	13 & 14	13 & 14
24	3-8, 9-12	11-12	2 & 1	10 & 14	13 & 14	13 & 14
25	3-4, 5-8, 9-12	5-10, 11-12	2 & 1	4 & 1	13 & 14	13 & 14
26	3-6, 7-8, 9-12	7-10, 11-12	2 & 1	6 & 1	13 & 14	13 & 14
27	3-4, 5-6, 7-8, 9-12	5-6, 7-10, 11-12	2 & 1	4 & 1	13 & 14	13 & 14
28	3-10, 11-12	9-10, 11-12	2 & 1	8 & 1	13 & 14	13 & 14
29	3-4, 5-10, 11-12	5-8, 9-10, 11-12	2 & 1	4 & 1	13 & 14	13 & 14
30	3-6, 7-10, 11-12	7-8, 9-10, 11-12	2 & 1	6 & 1	13 & 14	13 & 14
31	3-4, 5-6, 7-10	5-6, 7-8, 9-10, 11-12	2 & 1	4 & 1	13 & 14	13 & 14
32	3-8, 9-10, 11-12	2 & 1	13 & 14
33	3-4, 5-8, 9-10, 11-12	2 & 1	13 & 14
34	3, 6, 7-8, 9-10, 11-12	2 & 1	13 & 14
35	3-4, 5-6, 7-8, 9-10, 11-12	2 & 1	13 & 14

Table 5

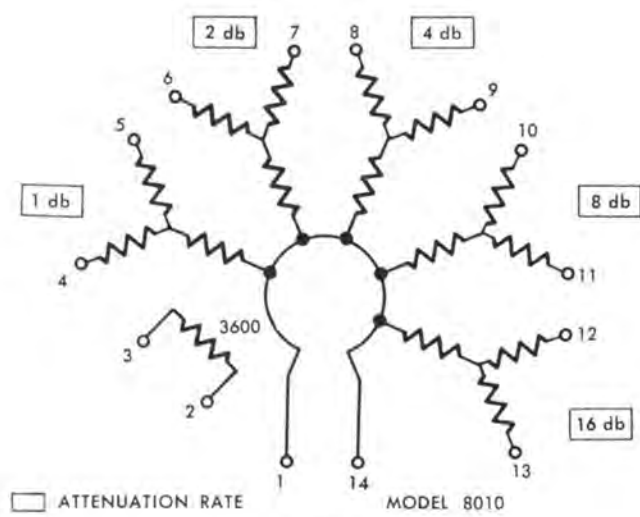

Figure 7

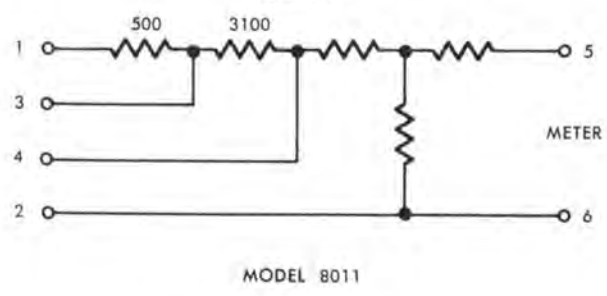

Figure 8

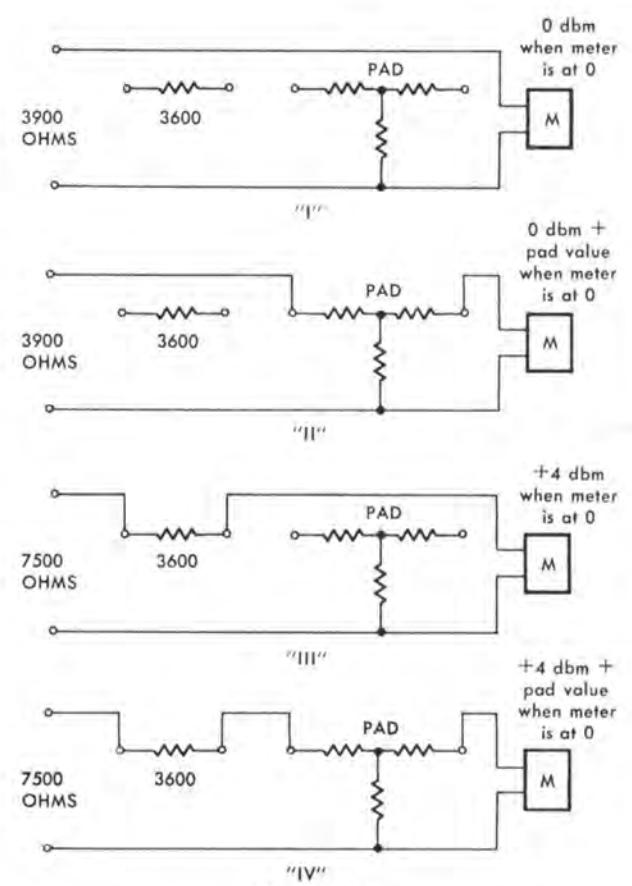

Figure 9

The block diagram, Figure 9, indicates the various ways that VU meters may be used. Circuit "I" may be used under normal conditions and with the meter 'bridged' across a 600 ohm line, it will indicate "0" on the meter scale for a line level of 0 dbm, when 1 milliwatt is applied to the line. With circuit "III," the meter will indicate 0 when the true line level is actually +4 dbm, and therefore, 4 db must be added to all readings.

If the line levels require the use of a pad, the circuits used in Figure 9 "II" and "IV" must be used, and the meter reading must be adjusted according to the value of the pad. For example: A 10 db pad in the circuit would require an adjustment of +10 db for the "II" configuration and +14 db for the "IV" configuration when the meter indicates 0 on the scale.

8012 FIXED LOSS PAD — Adjustable — Unbalanced
8013 FIXED LOSS PAD — Adjustable — Balanced

The Altec 8012 and the 8013 Fixed Loss Pads are identical to the 8006 and the 8007 except that the range has been extended to 63 db.

These loss pads utilize steps of 1 db, using combinations of 1, 2, 4, 8, 16, and 32 db. The model 8012 uses the unbalanced "T" circuit and the model 8013 uses the balanced "H" circuit. Table 6 illustrates the method used to accomplish the various loss values. Figure 10 diagrams the circuits used in these Fixed Loss Pads.

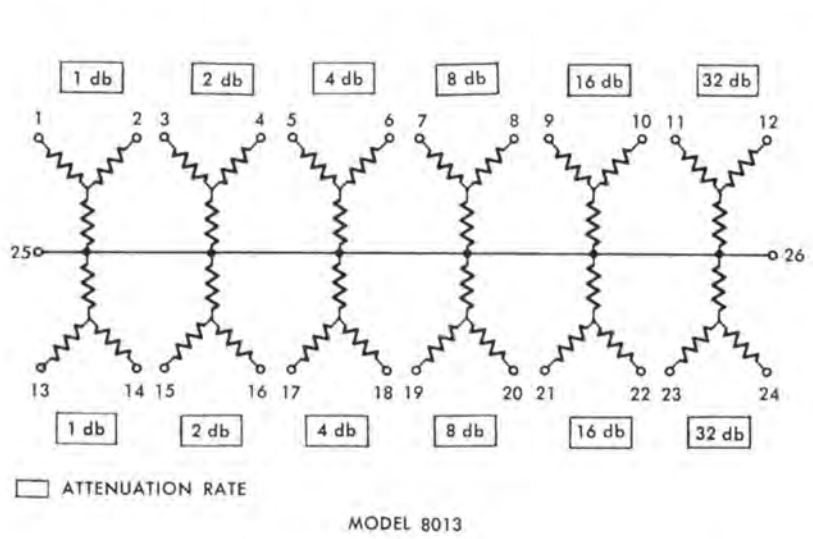

MODEL 8013

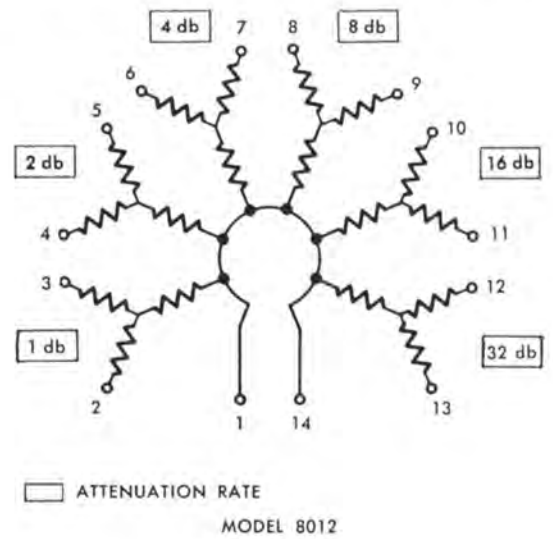

MODEL 8012

Figure 10

STRAPPING TABLE FOR THE MODEL 8012 AND 8013 FIXED LOSS PADS

LOSS REQUIRED	STRAPPING		INPUT		OUTPUT	
	8012	8013	8012	8013	8012	8013
1 db	None	None	1 & 2	1 & 13	3 & 14	2 & 14
2 db	None	None	4 & 1	3 & 15	5 & 14	4 & 16
3 db	3-4	2-3, 14-15	2 & 1	1 & 13	5 & 14	4 & 16
4 db	None	None	6 & 1	5 & 11	7 & 14	6 & 18
5 db	3-6	2-5, 14-17	2 & 1	1 & 13	7 & 14	6 & 18
6 db	5-6	4-5, 16-17	4 & 1	3 & 15	7 & 14	6 & 18
7 db	3-4, 5-6	2-3, 4-5, 14-15, 16-17	1 & 2	1 & 13	7 & 14	6 & 18
8 db	None	None	8 & 1	7 & 19	9 & 14	8 & 20
9 db	3-8	2-7, 14-19	2 & 1	1 & 13	9 & 14	8 & 20
10 db	5-8	4-7, 16-19	4 & 1	3 & 15	9 & 14	8 & 20
11 db	3-4, 5-8	2-3, 4-7, 14-15, 16-19	2 & 1	1 & 13	9 & 14	8 & 20
12 db	7-8	6-7, 18-19	6 & 1	5 & 17	9 & 14	8 & 20
13 db	3-6, 7-8	2-3, 4-7, 14-15, 16-19	2 & 1	1 & 13	9 & 14	8 & 20
14 db	5-6, 7-8	4-5, 6-7, 16-17, 18-19	4 & 1	3 & 15	9 & 14	8 & 20
15 db	3-4, 5-6, 7-8	2-3, 4-5, 6-7, 14-15, 16-17, 18-19	2 & 1	1 & 13	9 & 14	8 & 20
16 db	None	None	10 & 14	9 & 21	11 & 14	10 & 22
17 db	3-10	2-9, 14-21	2 & 1	1 & 13	11 & 14	10 & 22
18 db	5-10	4-9, 16-21	4 & 1	3 & 15	11 & 14	10 & 22
19 db	3-4, 5-10	2-3, 4-9, 14-15, 16-21	2 & 1	1 & 13	11 & 14	10 & 22
20 db	7-9	6-9, 18-21	6 & 1	5 & 17	11 & 14	10 & 22
21 db	3-6, 7-10	2-5, 6-9, 14-17, 18-21	2 & 1	1 & 13	11 & 14	10 & 22
22 db	5-6, 7-10	4-5, 6-9, 16-17, 18-21	4 & 1	3 & 15	11 & 14	10 & 22
23 db	3-4, 5-6, 7-10	2-3, 4-5, 6-9, 14-15, 16-17, 18-21	2 & 1	1 & 13	11 & 14	10 & 22
24 db	9-10	8-9, 20-21	8 & 1	7 & 19	11 & 14	10 & 22
25 db	3-8, 9-10	2-7, 8-9, 14-19, 20-21	2 & 1	1 & 13	11 & 14	10 & 22
26 db	5-8, 9-10	4-7, 8-9, 16-19, 20-21	4 & 1	3 & 15	11 & 14	10 & 22
27 db	3-4, 5-8, 9-10	2-3, 4-7, 8-9, 14-15, 16-19, 20-21	2 & 1	1 & 13	11 & 14	10 & 22
28 db	7-8, 9-10	6-7, 8-9, 18-19, 20-21	6 & 1	5 & 17	11 & 14	10 & 22
29 db	3-6, 7-8, 9-10	2-5, 6-7, 8-9, 14-17, 18-19, 20-21	2 & 1	1 & 13	11 & 14	10 & 22
30 db	5-6, 7-8, 9-10	4-5, 6-7, 8-9, 16-17, 18-19, 20-21	4 & 1	3 & 15	11 & 14	10 & 22
31 db	3-4, 5-6, 7-8, 9-10	2-3, 4-5, 6-7, 8-9, 14-15, 16-17, 18-19, 20-21	2 & 1	1 & 13	11 & 14	10 & 22
32 db	None	None	12 & 1	11 & 23	13 & 14	12 & 24
33 db	3-12	2-11, 14-23	2 & 1	1 & 13	13 & 14	12 & 24
34 db	5-12	4-11, 16-23	4 & 1	3 & 15	13 & 14	12 & 24
35 db	3-4, 5-12	2-3, 4-11, 14-15, 16-23	2 & 1	1 & 13	13 & 14	12 & 24
36 db	7-12	6-11, 18-23	6 & 1	5 & 17	13 & 14	12 & 24
37 db	3-6, 7-12	2-5, 6-11, 14-17, 18-23	2 & 1	1 & 13	13 & 14	12 & 24
38 db	5-6, 7-12	4-5, 6-11, 16-17, 18-23	4 & 1	3 & 15	13 & 14	12 & 24
39 db	3-4, 5-6, 7-12	2-3, 4-5, 6-11, 14-15, 16-17, 17-23	2 & 1	1 & 13	13 & 14	12 & 24
40 db	9-12	8-11, 20-23	8 & 1	7 & 19	13 & 14	12 & 24
41 db	3-8, 9-12	2-7, 8-11, 14-19, 20-23	2 & 1	1 & 13	13 & 14	12 & 24
42 db	5-8, 9-12	4-7, 9-11, 16-19, 20-23	4 & 1	3 & 15	13 & 14	12 & 24
43 db	3-4, 5-8, 9-12	2-3, 4-7, 8-11	2 & 1	1 & 13	13 & 14	12 & 24
44 db	7-8, 9-12	6-7, 8-11, 18-19, 20-23	6 & 1	5 & 17	13 & 14	12 & 24
45 db	3-6, 7-8, 9-12	2-5, 6-7, 8-11, 14-17, 18-19, 20-23	2 & 1	1 & 13	13 & 14	12 & 24
46 db	5-6, 7-8, 9-12	4-5, 6-7, 8-11, 16-17, 18-19, 20-23	4 & 1	3 & 15	13 & 14	12 & 24
47 db	3-4, 5-6, 7-8, 9-12	2-3, 4-5, 6-7, 8-11, 14-15, 16-17, 18-19, 20-23	2 & 1	1 & 13	13 & 14	12 & 24
48 db	11-12	10-11, 22-23	10 & 1	9 & 21	13 & 14	12 & 24
49 db	3-10, 11-12	2-9, 10-11, 14-21, 22-23	2 & 1	1 & 13	13 & 14	12 & 24
50 db	5-10, 11-12	4-9, 10-11, 16-21, 22-23	4 & 1	3 & 15	13 & 14	12 & 24
51 db	3-4, 5-10, 11-12	2-3, 4-9, 10-11, 14-15, 16-21, 22-23	2 & 1	1 & 13	13 & 14	12 & 24
52 db	7-10, 11-12	6-9, 10-11, 18-21, 22-23	6 & 1	5 & 17	13 & 14	12 & 24
53 db	3-6, 7-10, 11-12	2-5, 6-9, 10-11, 16-17, 18-21, 22-23	2 & 1	1 & 13	13 & 14	12 & 24
54 db	5-6, 7-10, 11-12	4-5, 6-9, 10-11, 16-17, 18-21, 22-23	4 & 1	3 & 15	13 & 14	12 & 24
55 db	3-4, 5-6, 7-10, 11-12	2-3, 4-5, 6-9, 10-11, 14-15, 16-17, 18-21, 22-23	2 & 1	1 & 13	13 & 14	12 & 24
56 db	9-10, 11-12	8-9, 10-11, 20-21, 22-22	8 & 1	9 & 21	13 & 14	12 & 24
57 db	3-8, 9-10, 11-12	2-7, 8-9, 10-11, 14-19, 20-21, 22-23	2 & 1	1 & 13	13 & 14	12 & 24
58 db	5-8, 9-10, 11-12	4-7, 8-9, 10-11, 16-19, 20-21, 22-23	4 & 1	3 & 15	13 & 14	12 & 24
59 db	3-4, 5-8, 9-10, 11-12	2-3, 4-7, 8-9, 10-11, 14-15, 16-19, 20-21, 22-23	2 & 1	1 & 13	13 & 14	12 & 24
60 db	7-8, 9-10, 11-12	6-7, 8-9, 10-11, 18-19, 20-21, 22-23	6 & 1	5 & 17	13 & 14	12 & 24
61 db	3-6, 7-8, 9-10, 11-12	2-5, 6-7, 8-9, 10-11, 14-17, 18-19, 20-21, 22-23	2 & 1	1 & 13	13 & 14	12 & 24
62 db	5-6, 7-8, 9-10, 11-12	4-5, 6-7, 8-9, 10-11, 16-17, 18-19, 20-21, 22-23	4 & 1	3 & 15	13 & 14	12 & 24
63 db	3-4, 5-6, 7-8, 9-10, 11-12	2-3, 4-5, 6-7, 8-9, 10-11 14-15, 16-17, 18-19, 20-21, 22-23	2 & 1	1 & 13	13 & 14	12 & 24

NOTICE
We recommend that you obtain your Altec products from factory trained authorized Altec Sound Contractors and Distributors. This will assure you of proper installation, a continuing source of knowledgeable advice, service, and quick warranty protection.

PLAYBACK *and speech-input* equipment for recording and broadcast studios

ALTEC
MICROPHONES

M-30 CAROID MICROPHONE SYSTEM

The M-30 provides the literally smooth response plus the exceptional front-to-back cardioid discrimination that only an instrument-type condenser microphone is capable of. The frequency characteristic of the M-30 Condenser is entirely free of the small irregularities in response that are common to most dynamics, and discrimination exceeds 20 decibels throughout critical feedback midrange extending to better than 10 db even at frequency extremes. Its small size and unobtrusiveness make it particularly popular for all types of pickup where the performer is in view, such as in television, motion pictures, etc. Being a condenser type transducer, it is absolutely free of magnetic hum pickup and can be used next to high power stage lighting. It comes equipped with a delicate shock-absorbing mounting to further enhance its selection for quiet recording and pickup of low level orchestral passages.

ENGINEERING SPECIFICATIONS

29A MICROPHONE HEAD, TYPE: Condenser. **DIRECTIVITY:** Cardioid. **FREQUENCY RANGE:** 20 to 15,000 cps. **HUM:** Not susceptible to magnetic fields. **CAPACITANCE:** 50 mmf. **DIMENSIONS:** 3/4" Diameter, 2 1/2" Seated Height. **FINISH:** Stainless Steel. **175A BASE, DIMENSIONS:** 1 1/4" Diameter, 2 1/4" Long. **TUBE:** 1 type 5840. **FINISH:** Anodized gray. **166A STAND ATTACHMENT, MOUNTING:** 3/8" - 27 thread. **FINISH:** Gray. **169A SHOCK MOUNT, MOUNTING:** 3/8" - 27 thread. **FINISH:** Gray. **525A POWER SUPPLY, POWER REQUIREMENTS:** 117 volts, 60 cycles, 15 watts. **SYSTEM OUTPUT LEVEL FROM POWER SUPPLY—UNBALANCED:** High Impedance (10,000 ohms or higher)—35 db/1v/10 dynes/cm² (open circuit voltage). 600 ohms—54 dbm/10 dynes/cm². 150 ohms—58 dbm/10 dynes/cm². 30 ohms—64 dbm/10 dynes/cm². **BALANCED:** Using 4665 Plug-in Transformer (must be ordered as an accessory) for 30, 150 or 600 ohms—53 dbm/10 dynes/cm². **LOAD IMPEDANCE:** 30, 150, 600 balanced (using 4665 Transformer), 30, 150, 600, 10,000 ohms unbalanced. **DIMENSIONS:** 2 3/8" H, 8 3/8" W, 7 1/2" D. **FINISH:** Gray anodized panel, silver gray case.



M-20 OMNI-DIRECTIONAL CONDENSER MICROPHONE SYSTEM

The M-20 System has same excellent condenser performance abilities of the M-30 System except that the M-20 is an omni-directional microphone. The M-20's ruggedness is attested by almost universal use by aircraft laboratories

for in-flight and ground noise instrumentation. It represents the only all American-made condenser microphone system on the market today, and outstrips foreign imports in years of acceptance by broadcast and recording engineers who dedicate their work as an art.



ENGINEERING INSTRUCTIONS

TYPE: Condenser—Omnidirectional. **FREQUENCY RESPONSE:** 10 to 15,000 cycles. **OUTPUT LEVEL (UNBALANCED):** @ 30 ohms, —59 dbm/10 dynes/cm². @ 150 ohms, —53 dbm/10 dynes/cm². @ 600 ohms, —49 dbm/10 dynes/cm². @ Hi Z, 44 dbm/10 dynes/cm² (10,000 ohms) or —30 db/1 v/10dynes/cm². **BALANCED:** Using 4665 plug-in transformer (must be ordered extra as an accessory) for 30, 150, or 600 ohms. —48 dbm/10 dynes/cm². **LOAD IMPEDANCE:** 30, 150, 600 and 10,000 ohms, unbalanced, 30, 150, and 600 ohms, balanced using 4665 transformer. **PICK UP PATTERN:** Omnidirectional. **HUM:** Not susceptible to magnetic fields. **CAPACITANCE:** 6 mmf. **21D MICROPHONE DIMENSIONS:** 3/8" diameter, height 3/8". **21D MICROPHONE WEIGHT:** 1/4 oz. **UNIT SEPARATION:** The microphone may be separated from the power supply up to 400 feet without any impairment in operation. **CATHODE FOLLOWER TUBE:** One 5840. **165A BASE DIMENSIONS:** Length 2 1/4" (length in 166A attachment 5 1/4" including 21D). Diameter 1 1/4". Weight 2 1/2 oz. **166A STAND ATTACHMENT:** Length 3 3/4", Diameter 3/4". **525A POWER SUPPLY DIMENSIONS:** Length 8 3/8", Width 2 3/8", Depth 7 1/2", Weight 5 1/2 lbs. **525A POWER REQUIREMENTS:** 117 volts, 60 cycle, 15 watts. **MICROPHONE MOUNTING:** Suspension or hand held; and, with 166A attachment, 3/8" - 27 thread. **FINISH:** Microphone unit: stainless steel. Stand attachment: instrument gray of high impact styrene. Power supply: instrument gray.

168A AND 170A WIND SCREENS

168A is a two-stage screen for use with M-20 Microphone Systems for suppression of wind noise and is recommended for outdoor applications is subjected to movement on a boom and to protect against breath blast in close talking.

170B is a two-stage wind screen for use with the M-30 Microphone System and features a maximum of protection against wind noise (approximately 24 db reduction).

11853 RACK MOUNTING ASSEMBLY

This rack mounting assembly provides standard 19" rack mounting facilities for two 525A Altec Power Supply units as used in the Altec M-20 and M-30 Microphone Systems. Rack space (3 1/2").





639A/B VARIABLE PATTERN CARDIOID MICROPHONE

The 639 Microphone, originally developed by the Bell Laboratories, has remained as a recognized standard in the recording, motion picture, and broadcast field for two decades. It consists of two independent elements, one dynamic and one velocity (ribbon), carefully phased and acoustically integrated to provide the finest poly-pattern microphone in current manufacture. The selective six directional patterns of the 639B, ranging from cardioid through Figure 8, to omnidirectional, result in an instrument for universal application of unfailing quality capable of producing the constant-standard results required in broadcast, motion picture and phonograph recording. Sometimes known as a "super cardioid", because of its high front to back pick-up ratio in the all-important mid-range, the 639 Microphone has contributed its quality towards the "Oscars" awarded a number of motion pictures by the Academy of Motion Picture Arts and Sciences for outstanding sound. See Microphone Accessories sheet AL 1327-H for necessary mounting assemblies.

ENGINEERING SPECIFICATIONS

FREQUENCY RESPONSE: 40 to 10,000 cycles. **OUTPUT IMPEDANCE:** 30/50 ohms. **OUTPUT LEVEL:** —52 dbm/10 dynes/cm². **PICKUP PATTERN:** 639A-3-directional pattern, 639B-6-directional pattern. **HUM:** —120 db (Ref.: 10⁻³ Gauss). **PROTECTION:** Two stage wind screen. **DIMENSIONS:** 7 1/2" H (including plug) x 3 3/8" W x 4 3/8" D. **WEIGHT:** 3 1/4 lbs. **FINISH:** Instrument gray.

633A/C OMNI-DIRECTIONAL DYNAMIC MICROPHONE

Originally designed by the Bell Laboratories and marketed under the banner of the Western Electric Company for many years, the 633A is affectionately known among broadcast and recording people as the "salt shaker" with a reputation of being the most rugged of all utility microphones. The ruggedness and durability of this microphone have lately been updated by conversion from its original aluminum diaphragm to a non-crushable diaphragm of mylar and the addition of the new standardized impedance of 150/250 ohms under the code number of 633C. See Microphone Accessories sheet AL 1327-H for necessary mounting assemblies.

ENGINEERING SPECIFICATIONS

FREQUENCY RESPONSE: 35 to 12,000 cycles. **OUTPUT IMPEDANCE:** 633A—30/50 ohms, 633C—30/50, 150/250 ohms, selective. **OUTPUT LEVEL:** —55 dbm/10 dynes/cm². **DIMENSIONS:** Length 3 1/2", Diameter 2". **WEIGHT:** 633A—10 ozs., 633C—13 ozs. **FINISH:** Instrument gray. **MOUNTING:** 3/8" - 24 thread.



690A MICROPHONE

The 690A provides distinct quality improvement for all local paging and inter-communication applications wherein the standard carbon transmitter has previously been employed. The wide frequency range (three times that of the carbon unit) and low distortion characteristics provide outstanding clarity and intelligibility for critical speech applications.

The integral, encapsulated transistor amplifier of the 690A obtains its operating voltage from the associated telephone/intercom line or external power source; the Mylar diaphragm and sintered bronze filter furnish maximum protection against blast, shock and moisture.

ENGINEERING SPECIFICATIONS

TYPE: Dynamic microphone with transistor amplifier. **SENSITIVITY:** —3 dbm for 10 dynes/cm² (Z_i = 100 ohms); —38 db referred to 1 volt re 1 dyne/cm², open circuit voltage. A 6 db reduction in sensitivity may be obtained by removing external strapping (under protective synthetic foam plug). **MAXIMUM OUTPUT:** 1 volt (RMS) at clipping level, 100-ohm load; 3 volts (RMS) at clipping level, 333-ohm load. Output signal is developed across impedance in series with DC power supply. **GAIN VARIATION:** Fixed load (100 ohms): With a 5- to 18-volt supply, gain variation is ±1 db; with 3.5-volt supply, gain variation is —3 db. Fixed supply (21 volts): With 200 to 1100 load, ±1 db; with 1500-ohm load, —3 db. **LOAD IMPEDANCE:** 100 ohms to infinity. **POWER SUPPLY REQUIREMENTS:** 14 VDC (Maximum terminal voltage) @ 30 ma, 3.5 VDC @ 15 ma. **APPLICATION:** Mechanical and electrical replacement for carbon transmitters for G1-type handsets utilized in local paging and intercom applications. **OPERATING TEMPERATURE RANGE:** To 45 degrees, Centigrade. **CONNECTIONS:** 2 screw terminals. **DIMENSIONS:** 1 3/8" Diameter; 1" High (excluding cord clamp). **WEIGHT:** 3 ounces. **CASE:** Molded epoxy, encapsulating and amplifier assembly.

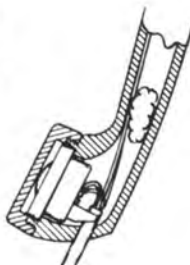

If You Didn't Get This From My Site,
Then It Was Stolen From...

www.SteamPoweredRadio.Com

632C Dynamic Microphone

632C



- Specialized speech instrument
- Close-talking
- High intelligibility
- Temperature & humidity proof
- Small size
- High output
- Low impedance
- Rugged
- Flexible
- Inexpensive

The 632C is specifically designed for clear, intelligible speech reproduction. This rugged close-talking microphone provides excellent results even where high ambient noise, background sound, or reverberation cause conventional microphones to be unsatisfactory. Its acoustically equalized frequency response generally eliminates the need for special speech equalization equipment in the associated amplifier system.

This true dynamic has a sensitive aluminum diaphragm employing tangential compliance, an edge-wound aluminum ribbon voice coil, and a highly efficient magnetic structure. This element is structurally protected from damage by loud speech or blowing and is unaffected by temperature changes, humidity, or breath condensation. A sturdy aluminum case minimizes danger of physical damage to the microphone.

Because of its low 30/50 ohm output impedance, the 632C may be operated several hundred feet from the amplifier without increasing noise pickup. As supplied, the 632C mounts directly on a stand in a vertical position. It may be "hand-held" or suspended from its cord. For angle mounting, the accessory 9A Swivel should be ordered. When the microphone is frequently taken from the stand, the 311A Plug may be attached for "plug-in" facility. The 422A Jack is used to terminate the microphone cord.

This specialized speech microphone offers the solution to many acoustical problems encountered in public address, paging, and roving announcement work, indoors or out. Its durability, performance, and truly reasonable price suit the 632C to most complex as well as to simplest sound installations.



A Subsidiary of Ling-Temco-Vought, Inc.

1515 S. Manchester Ave., Anaheim, Calif.
New York

SPECIFICATIONS

Type:	Dynamic
Frequency Response:	100 to 10,000 cycles
Output Impedance:	30/50 ohms
Output Level:	-55 dbm/10 dynes/cm ²
Dimensions:	Length 2 1/8" Diameter 2"
Weight:	8 1/4 ozs.
Finish:	Instrument gray
Mounting:	5/8" - 24 direct mounting

ACCESSORIES

See "Microphone Accessories" sheet for desk or floor stands, on-off switches, adapters, and other microphone accessories.

ARCHITECTS AND ENGINEERS SPECIFICATIONS

This microphone shall be of the dynamic moving coil type. It shall have an aluminum diaphragm with tangential compliance and the voice coil shall be of aluminum ribbon edge-wound. The frequency response shall be from 100 to 10,000 cycles. At 100 cycles it shall be approximately 6 db down and at 10,000 cycles shall be approximately 5 db down. From 150 to 10,000 cycles it shall have a gradually rising characteristic. This microphone shall have an impedance of 30/50 ohms and shall be balanced with respect to ground. The diameter of the microphone shall not exceed 2" with a length of not more than 2 1/8". The mounting adapter shall have 5/8" - 24 threads.

The microphone shall weigh not more than 8 1/4 ozs. The microphone shall be designed for close-talking operation. The unit shall be such as to be used with plug, jack, and adapter where specified. The output level of the microphone shall be at least -55 dbm/10 dynes/cm².

This microphone shall be Altec Lansing Model 632C.

NOTICE
We recommend that you obtain your Altec products from factory trained authorized Altec Sound Contractors and Distributors. This will assure you of proper installation, a continuing source of knowledgeable advice, service, and quick warranty protection.

PLAYBACK and speech-input equipment
for recording and broadcast studios

ALTEC
MICROPHONES



ALTEC'S REMARKABLE
SINTERED BRONZE FILTER

Most perfect acoustical filter known . . . This exclusive Altec development provides absolute protection against the gradual degradation of quality so commonly experienced in ordinary microphones caused by the microphone magnet constantly attracting microscopic airborne magnetic particles onto the diaphragm, which in turn loads and restricts diaphragm motion and destroys high frequency response. No other filter is as effective in preventing magnetic dust entry as the sintered bronze filter. Altec microphones 682A, 683A, 684A, 685A, 686A, 687A, and 690A contain the sintered bronze filter.

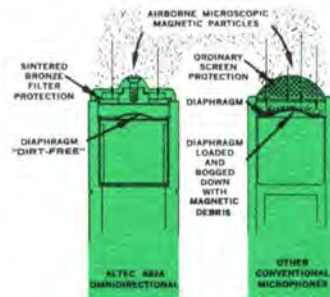

685A CARDIOID DYNAMIC MICROPHONE

The 685A provides the audio engineer with a general purpose, high quality microphone for a variety of studio uses. Its response is very slightly "tilted" upward to provide the presence-projection that is so important for announcing and newscasting, as well as to enhance a vocalist pick-up from an orchestral background. Besides being equipped with a non-crushable diaphragm of mylar, the 685A is also equipped with an exclusive sintered bronze filter which gives positive protection against the entrance on to the diaphragm of airborne magnetic dust, which condition is the common cause of the slow

quality deterioration that occurs with all ordinary dynamics. A "lock-in" feature assures positive mounting or, when desired, permits easy removal of the microphone from the stand for hand-held use by roving singers or interviewers. This easy-remove feature plus exceptional front-to-back cardioid discrimination makes the 685A ideal for audience participation shows. Two-tone green and black color prevents light reflection when the microphone is used before television and movie cameras. A Bruel and Kjaer automatically recorded frequency response chart comes with each 685A.

ENGINEERING SPECIFICATIONS

FREQUENCY RESPONSE: 40 to 16,000 cycles (calibration chart included). **OUTPUT IMPEDANCE:** 30/50, 150/250 and 20,000 ohms (selection by connections in microphone cable plug). The microphone is shipped with leads connected for 150/250 ohms. **OUTPUT LEVEL:** —54 dbm/10 dynes/cm². **DISCRIMINATION:** Average front to back, 20 db. **PICKUP PATTERN:** Cardioid. **HUM:** —120 db (Ref.: 10⁻³ Gauss). **DIMENSIONS:** 1½" diameter at top, 7¼" long not including plug. **WEIGHT:** 11 ozs. (not including cable and plug). **FINISH:** Two-tone baked enamel, black and dark green. **MOUNTING:** Separate "Slip-On" adapter No. 13798 (black) furnished. Adapter has standard ¾" - 27 thread. Swivel mounting permits proper positioning of microphone on all stands. Microphone includes a 15 foot, 2 conductor shielded cable with microphone plug.



684A OMNI-DIRECTIONAL DYNAMIC MICROPHONE

The 684A is the omni-directional counterpart of the 685A. It incorporates the same design features including the exclusive sintered bronze filter. Due to being omni-directional, rather than cardioid, it offers a somewhat wider frequency response which gives it favor for uses where a cardioid pattern is not essential. Each microphone is accompanied with frequency characteristic chart of the particular microphone measured in Altec's anechoic chamber by a Bruel and Kjaer automatic recorder.

ENGINEERING SPECIFICATIONS

PICKUP PATTERN: Omnidirectional. **FREQUENCY RESPONSE:** 35 to 20,000 cycles. **OUTPUT IMPEDANCE:** 30/50, 150/250 and 20,000 ohms (selection by connections in microphone cable plug). **OUTPUT LEVEL:** —55 dbm/10 dynes/cm². **HUM:** —120 db (Ref.: 10⁻³ Gauss). **DIMENSIONS:** 1¼" diameter at top (1½" largest diameter) 7½" long not including plug. **WEIGHT:** 8 ozs. (not including cable and plug). **FINISH:** Two-tone baked enamel, black and dark green. **MOUNTING:** Separate "Slip-On" adapter No. 13798 furnished. Adapter has standard ¾" - 27 thread. Swivel mounting permits proper positioning of the microphone on all stands. Microphone includes 15 feet, 2 conductor shielded cable with microphone plug.



686A DYNAMIC LAVALIER MICROPHONE

Small, lightweight and unobtrusive, the 686A has the widest frequency range and highest sensitivity of any dynamic lavalier-type microphone on the market today which accounts for its superiority among newscasters and the choice of moderators for panel shows, both on television and radio. It, also, is protected against slow quality deterioration by Altec's exclusive sintered bronze filter which prevents the entrance of airborne magnetic dust on to its mylar diaphragm.

ENGINEERING SPECIFICATIONS

FREQUENCY RESPONSE: 70 to 20,000 cycles used as a "Lavalier". **OUTPUT IMPEDANCE:** 30/50 and 150/250 ohms (selectable by connections in plug at end of microphone cable). **OUTPUT LEVEL:** —55 dbm/10 dynes/cm². **PICKUP PATTERN:** Omnidirectional. **HUM:** —120 db (Ref.: 10⁻³ Gauss). **DIMENSIONS:** 1¼" diameter at top tapered to ¾" at cable entrance, 3½" long. **WEIGHT:** 2½ ozs. (not including cable and plug). **FINISH:** Baked enamel, non-glare dark green. **MOUNTING:** "Snap-on" Lavalier neck cord No. 13356 and spring type tie or lapel clip No. 13322. Microphone complete with 20 foot, 3-conductor, rubber-covered shielded cable and plug.





Typical calibrated chart
for 684A, 685A, 688A, 689A

CERTIFIED CALIBRATION CURVES

Altec professional microphones 684A, 685A, 688A and 689A are each supplied with their own individual certified calibration curve. These microphones are accurately measured in Altec's 20' x 18' x 16' Anechoic Chamber and are charted with an automatic Bruel & Kjaer Oscillator, Graphic Recorder and a calibrated control microphone. These documented curves supply the station engineer with visual proof that the microphone meets the performance specifications and serves as a valuable aid in matching microphones for stereophonic pickup.

689A CARDIOID DYNAMIC MICROPHONE

The 689A Cardioid has a carefully adjusted "flat response" particularly tailored for wide range pickup for fine music recordings and full symphony broadcasts. Packed with each 689A is an individual, anechoic chamber measured, frequency response chart made on a precision Bruel and Kjaer automatic recorder. Although there is extremely small variation between different units, this curve provides a permanent record to assure that microphones selected for two and three channel stereo pickup are of identical characteristic. The 689A is equipped with a mylar "golden diaphragm" and has a "lock-in" facility to assure that the microphone will not accidentally slip out of its holder when used in either boom or floor stand mount. The color is a dull, non-reflective green and black which will not attract attention when visible to the audience in television or motion picture use.



ENGINEERING SPECIFICATIONS

FREQUENCY RESPONSE: 40 to 16,000 cycles. **OUTPUT IMPEDANCE:** 30/50, 150/250 and 20,000 ohms (selection by connections in microphone cable plug). **OUTPUT LEVEL:** -54 dbm/10 dynes/cm². **DISCRIMINATION:** Average front to back, 20 db. **PICKUP PATTERN:** Cardioid. **HUM:** -120 db (Ref.: 10⁻³ Gauss). **DIMENSIONS:** 1 1/2" diameter at top, 7 3/8" long not including plug. **WEIGHT:** 11 ozs. (not including cable and plug). **FINISH:** Two-tone baked enamel, black and dark green. **MOUNTING:** Separate "Slip-On" adapter No. 13798 (black) furnished. Adapter has standard 3/8" - 27 thread. Swivel mounting permits proper positioning of the microphone on all stands. 15 feet of two-conductor, shielded cable (80% shield) is supplied with the microphone.

688A OMNI-DIRECTIONAL DYNAMIC MICROPHONE

The 688A is constructed and has features similar to the 689A except that its pickup pattern is omni-directional. It is directed to wide range pickup of fine music where a microphone having an exceptionally "flat" characteristic is required and is particularly adaptable for single microphone techniques. The 688A likewise is supplied with an individual frequency response calibration, automatically drawn by a Bruel and Kjaer recorder.

ENGINEERING SPECIFICATIONS

FREQUENCY RESPONSE: 35 to 20,000 cycles. **OUTPUT IMPEDANCE:** 30/50, 150/250 and 20,000 ohms (selection by connections in microphone cable plug). **OUTPUT LEVEL:** -55 dbm/10 dynes/cm². **HUM:** -120 db (Ref.: 10⁻³ Gauss). **DIMENSIONS:** 1 1/8" diameter at top (1 1/2" largest diameter) 7 1/2" long not including plug. **WEIGHT:** 8 ozs. (not including cable and plug). **FINISH:** Two-tone baked enamel, black and dark green. **MOUNTING:** Separate "Slip-On" adapter No. 13798 furnished. Adapter has standard 3/8" - 27 thread. Swivel mounting permits proper positioning of the microphone on all stands. 15 feet of 2 conductor shielded cable (80% shield) is supplied.



181A BOOM MOUNT

The 181A Mount for microphone boom use is an accessory item that has been designed for use with Altec microphones. The 181A may be adjusted over an arc of 45°. It is extremely light in weight with a non-glare enamel finish which reduces the reflection of studio lighting. The 181A includes a nipple with 3/8" - 27 threads which is used to attach the microphone mounting facility to the shock mount shroud.

Microphones not equipped with slip-on adapters may be coupled directly to the shroud by means of the 3/8" - 27 threaded nipple.



Altec Microphone Accessories



4A SWITCH

The 4A Microphone Switch is designed for use with the 682, 683, 684 and 685 ALTEC Microphones. These microphones being equipped with 5 pin Cannon XLR-5-12 Connectors will accept the XLR-5-11 Cannon Plug in the 4A switch assembly.

When the switch is in the "Off" position a "short" is placed across the microphone. When the switch is moved to the "On" position, the short is removed and the microphone is ready for operation.

This facility makes it possible to use this switch with any of the above series microphones and the attachment of the switch does not require any change in the microphone connections or wiring.



7A MICROPHONE SWITCH

Designed for use with the ALTEC 26A desk type microphone stand. The switch kit includes a red jewel, pilot light and socket (GE #12 for 6.3v operation). The switch incorporates both "push-to-talk" and "lock-to-talk" positions which also provides the necessary switch contacts for remote relay or similar operations.

Two sets of contacts comprise the 7A switch: The first, a shorting (Form 'A') arrangement places a short across the microphone line when idle; the short is removed when the control knob is depressed. The second portion of the switch utilizes a transfer (Form 'C') contact, whereby a single input line is connected to one of two output lines, depending upon the position of the control button. The spare (Form 'C') contacts may be used for the operation of relays, indicator lights, etc.

Rotating the control button 90 degrees places both switches in a locking position for messages of long duration; return of the knob to its original position once again places the short across the microphone line and operates the 'Form C' section. A white indicator line clearly indicates the position of the button at a glance.



22C FLOOR STAND

The ALTEC 22C is a rugged microphone floor stand weighing thirteen pounds. The stand has a wrinkle gray base with a chrome stand. The 22C stand is adjustable from 35 inches to 64 inches, has a $\frac{3}{8}$ " - 27 thread for attaching microphone. A separate adapter for $\frac{3}{8}$ " - 24 microphone thread is also furnished.



24C DESK STAND

The ALTEC 24C is a desk stand that provides the proper microphone height on speakers tables, etc. The 24C is gray in finish and has a $\frac{3}{8}$ " - 24 thread for microphone attachment. A separate adapter for $\frac{3}{8}$ " - 27 microphone threads is also furnished. The 24C Desk Stand weighs approximately three pounds.



A Division of *LSV* Ling Altec, Inc.

1515 S. Manchester Ave., Anaheim, Calif.
New York



26A DESK STAND

The ALTEC 26A Desk Stand is a sturdy microphone stand that weighs approximately two pounds and is finished in a dark green paint. The 26A includes a chrome finished stem riser having $\frac{3}{8}$ " - 27 threads which brings the overall height of the desk stand to approximately 4 inches. The cast iron base provides great stability of usage and protection against accidental microphone damage by tipping. Provisions are made on the 26A Desk Stand for the installation of the Altec 7A microphone switch.



34A SHOCK-MOUNTED DESK STAND

The 34A desk stand is a modern, functional addition to any microphone (having $\frac{5}{8}$ " - 27 thread) which must be mechanically isolated from any source of vibration. The 34A may be used with the 687 announce and page microphone, or, with the 12A adapter, the 34A desk stand may be used with the Altec 681, 682, 683, 684, 685, 688, or the 689 microphone. The 34A desk stand is particularly useful in areas which have a large amount of low-frequency ambient noise, such as industrial plants, transportation terminals, et.



181A BOOM MOUNT

The Altec 181A Boom Mount accommodates most microphones in current use; the light weight, simplified construction, and ease of installation combine to provide the benefits of adjustable shock-mounting for all fixed and mobile boom usage.



169A SHOCK MOUNT

The 169A unit is an accessory for use with the ALTEC M20 and M30 Microphone Systems. The 169A Shock Mount is equipped with a swivel and a $\frac{3}{8}$ " - 27 thread. The 169A unit mates with the ALTEC 22C Floor Stand and 26A Desk Stand or any standard microphone stands or "boom" with $\frac{3}{8}$ " - 27 thread. The 169A insulates the microphone effectively from noises that are transmitted through the microphone stand or "boom."



168A WIND SCREEN

The 168A is a two-stage wind screen for use with the ALTEC Type M20 microphones for suppression of wind noise. The 168A is recommended for outdoor applications when the microphone is subjected to movement on a boom or to protect against breath blast in close talking applications.



170B WIND SCREEN

The Altec 170B is a two-stage wind screen for use with the Altec M30 Microphone System for effective protection against the pickup and transmittal of undesired wind noise when the microphone is used outdoors, on a boom mount subject to rapid movement, or in close-talking applications. The 170B provides approximately 24db reduction against wind noise with minimal effect on the frequency response of the microphone.



166A STAND HOLDER

The 166A is used in the Altec M20 and M30 microphone systems. The 166A Holder grips the 165A microphone base providing a light streamlined swivel attachment for a floor or desk stand. The holder attains ruggedness by combining a molded high impact Styrene part with a satin chrome die cast swivel that contains a $\frac{1}{8}$ " - 27 thread.



525A POWER SUPPLY

The 525A Power Supply Unit is furnished with the ALTEC M20 and M30 Condenser Microphone Systems. The power supply provides the necessary voltages to the sub-miniature impedance matching tube and printed circuit in the 165A Base, to which the M20 or M30 microphone is attached and provides polarizing voltage to the condenser microphone.

Output from the Power Supply is for unbalanced lines. Balanced output can be obtained through the addition of the accessory 4665 matching Transformer.

The 525A measures 8 $\frac{1}{2}$ " W x 2 $\frac{3}{8}$ " H x 7 $\frac{1}{2}$ " D and two units may be rack mounted in a single 11853 Mounting. Power requirements: 117 volt, 60 cps, 15 watts.



4722 INPUT MATCHING TRANSFORMER

Provides low impedance microphone inputs for all Altec amplifiers requiring this plug-in microphone input transformer. Has 60 db electro-magnetic shielding; frequency response ± 1 db 30-15,000 cps; impedance 30/50, 100/200 (with C. T.), and 40,000/65,000 ohms maximum operating level: -25 dbm (above 60 cps: -19 dbm). Plug-in socket mounting. Dimensions 1 $\frac{3}{16}$ " diameter x 1 $\frac{1}{16}$ " high.



4665 PLUG-IN TRANSFORMER

Premium quality microphone or line to Grid Transformer for Altec amplifiers designed to accept this accessory: has 90 db of electro-magnetic shielding; frequency response ± 1 db 10-25,000 cps; impedance: 30/50, 125/150, 250/300 (with C. T.), 500/600 to 70,000/84,000 ohms. Maximum operating level: +8 dbm. The two mounting screws ground the transformer which insures quiet operation of the unit. Dimensions: 1 $\frac{1}{2}$ " x 2" x 2 $\frac{3}{16}$ " high.



5426 CABLE



1883-H6 CABLE

1883-H6 AND 5426 MICROPHONE CABLE

The 1883-H6 Microphone Cable is a slender fiberglass covered, highly flexible six-conductor cable as supplied with microphone bases in M20 and M30 Microphone Systems. For custom made extension cables between the microphone and power supply. Order required lengths.

The 5426 Microphone Cable is a rubber-covered six-conductor cable for heavy duty extensions between condenser microphone bases and power supplies in M20 and M30 Microphone Systems. Order required lengths. Beyond 400 feet, larger conductors should be used for the heater loads to avoid excessive voltage drop.



167A EXTENSION CABLE

The 167A extension cable is a rugged 25 foot extension cable equipped with Cannon RWK-6-22C and RWK 6-21C Connectors. The 167A Cable is for use with the Altec M20 and M30 microphone systems, between the microphone base and Power Supply. Special length cables are available up to 400 feet and may be used without impairing the operation of the microphones.

Altec Microphone Accessories



11853 RACK MOUNTING ASSEMBLY

The 11853 Rack Mounting Assembly provides standard 19 inch Rack Mounting facilities for two 525A Altec Power Supply units as used in the ALTEC M20 and M30 microphone systems. The 11853 assembly occupies only two units of rack space (3½").



13578 MOUNTING ASSEMBLY

The 13578 Mounting is primarily for use with the ALTEC 661C Dynamic Microphone. However, the 13578 Mount will also mate equally well with the 681A, 682A and the 686A Altec Microphones. The 13578 assembly may be mounted to any vertical or horizontal surface by three screws that are furnished.

The 13578 Microphone Mounting is small in size and extremely light in weight. Because of these features the installation of the 13578 Mounting can be made in a limited amount of space.

When the 686A Microphone is used in conjunction with the 13578 Adapter, the microphone should be inserted into the adapter until the microphone shoulder makes contact with the adapter shoulder.



SLIP-ON ADAPTERS

The Altec line of microphones, 681A through 685A are supplied with "slip-on" adapters. Additional adapters are available when required in brown and black to match with the proper adapter.

- For 681A & 682A Microphones — Black — 13796
- For 682A Microphones — Brown — 13797
- For 683A, 684A, 685A, 688A & 689A Microphones — Black — 13798
- For 683A Microphone — Brown — 13799

MICROPHONE ACCESSORIES FOR WESTERN ELECTRIC TYPES 639, 633, 632C



<p>8B ATTACHMENT 3¼" baffle provides semi-directional response from 633 Microphone.</p>	<p>11A ATTACHMENT Provides swivel, suspension mounting for the 639 Microphone. It may also be used on microphone stands when tilting of the microphone is desired. Has 5/8" — 24 male thread.</p>
<p>311A PLUG For use in 633 and 632C microphones, makes it possible to interchange these microphones with the 639.</p>	<p>KS-12,000 COVER Black, dust-proof cover for protection of 639 Microphone.</p>
<p>442A JACK Provides termination of microphone cord. When used with 712A Adapter, it properly connects to bottom of 639 Microphone and also to 311A Plug as used on 633 and 632C microphones.</p>	
<p>712A ADAPTER Used with 442A Jack, it provides greater mounting security.</p>	
<p>9A SWIVEL ATTACHMENT Is used with 633 and 632C microphones. Provides a 90 degree swivel. May be attached directly to microphone or used with 311A Plug, 442A Jack, and 712A Adapter. Has 5/8" — 24 male thread</p>	
<p>23A DESK STAND Slender desk stand particularly adapted for use with 633 or 632C microphone. Has 5/8" — 24 female thread. Dimension: Height 7½" Diameter 5"</p>	<p>713A ADAPTER This slotted connector permits the microphone cord to run outside of the microphone stand so that it is not necessary to disconnect the cord assembly when removing the microphone from the stand.</p>

NOTICE
 We recommend that you obtain your Altec products from factory trained authorized Altec Sound Contractors and Distributors. This will assure you of proper installation, a continuing source of knowledgeable advice, service, and quick warranty protection.

AMPLIFICATION

250 SU CONTROL CONSOLE

250SU

FOR ALL STEREO AND UNIVERSAL OPERATING FUNCTIONS



250 SU CONSOLE

The ultimate in product design and product usage is embodied in the new 250 SU Altec Control Console. This unit is the finest ever built for TV, AM, FM, Recording Studio or Sound System use. The 250 SU is a compact console providing the greatest flexibility attainable in mode of operation. This extreme flexibility is made possible by the use of newly designed miniature plug-in preamplifiers, program amplifiers, and utility input devices. The plug-in units are only $1\frac{3}{8}$ " wide, $3\frac{13}{16}$ " max. high and $9\frac{9}{16}$ " long, over handle. All units are the same in size to permit flexibility in the number and type of amplifiers used per console.

Single unit construction, namely amplifiers and controls in the same housing, is used because of simplified, less expensive installation. The power supply of any Control Console is always a potential source of undesirable hum inducing flux fields, and is, therefore, mounted external to the console. To keep the installation of the power supply simple, it is built into a separate housing, which may be mounted to the underside of a table, the table leg, or on an adjoining wall. A single screw frees the power supply unit from its mounting bracket for inspection. The model 535A Power Supply is furnished with a 4 foot interconnecting cable with plug for connection to the mating receptacles inside the console. The 250 SU Console requires no special table or mounting facilities as all leads terminate at "strips" located inside the console housing.

There are ten input positions and each is equipped with "bus" switches and mixer attenuators. Any input position may be used for EITHER high level or low level sources by inserting the proper input device. It is only necessary to order the number of microphone preamplifiers and/or utility input devices that is required for the particular installation. Mounting trays for the maximum of plug-in units are, however, installed and wired.

All output circuitry for single-channel, single-line, two-channel, two-line, dual stereo or three channel/two channel stereo is included and wired. It is only necessary to plug in the necessary number of amplifiers to provide the desired functions.

Three channel/two channel operation consists of using the center position of the "bus" selector key to feed a third or "center channel" mixing "bus." The output of the "bus" is amplified, then divided by means of a splitting pad and introduced into the left and right channels. For "stereo" use, this permits vocal or dialogue material to be picked up on a single microphone and evenly divided to the left and right channels without problems of balance, microphone matching, etc. In this case, the variable dialogue (speech) filter is connected in the center channel.

Splitting the center channel to left and right is also used in re-recording where the master tape is recorded full three channel then reduced to two channels for the release tape or disc.

Monitor amplifiers are not included as part of the console as small eight watt units frequently used for this purpose are inadequate with many current low efficiency speakers. Standard Altec amplifiers such as model 128B and 351B are recommended, mounted on a shelf or in a standard equipment cabinet.

A terminal strip has been provided in the console to which all major circuits connect. The purpose of this terminal is to allow these circuits to be "wired out" to an auxiliary equipment cabinet for the inclusion of jack strips, equalizers or other secondary equipment which may be required in the particular installation.

The center control panel contains a spare phone jack in addition to the two monitor jacks for use with an "intercom" system. This panel also contains a spare rotary selector switch. The panel marking process is such that additional characters for the spare selector and jack may be engraved with the desired designations and filled with "whiting" providing a proper match with the existing lettering.



A Division of *ESV* Ling Altec, Inc.

1515 S. Manchester Ave., Anaheim, Calif.

New York

RECORDING &

BROADCASTING

EQUIPMENT

Preamplifiers, program amplifiers, power supplies & accessories

Though designed primarily for use in the 250 SU Altec Control Console, these new miniature "plug-in" preamplifiers, program amplifiers, utility input device, power supply and meter assemblies are perfectly adaptable for rack mounting of speech input equipment for custom type installations. Rack mounting facilities are available for this use. These amplifiers will accept input level up to -15 dbm without exceeding 1% THD.

The dynamic range of 459A Program Amplifiers is equivalent to model 458A Preamplifier (see noise level specifications) making it suitable for preamplifier use where added channel gain is required. Mounting tray assemblies and plug-in connections are identical on all input devices. Part of the Mounting Tray Assembly is a miniature receptacle to which all connections are made. This receptacle "mates" with the plug on the amplifier and utility input devices. This "plug-in" feature combined with the uncrowded positioning of all components leaves all parts readily accessible when removed from the mounting tray.

458A PREAMPLIFIER



SPECIFICATIONS:

Gain: 40 db unterminated input, 34 db terminated.
 Power Output: $+20$ dbm at less than .5% THD 50 to 15,000 cps.
 $+25$ dbm at less than 1% THD at 1 KC.
 Frequency Response: ± 1 db 20 to 20,000 cps.
 Source Impedance: 150 or 600 ohms (centertap available when connected for 600 ohms).
 Load Impedance: 150 to 600 ohms (centertap available when connected for 600 ohms).
 Output Impedance: Equal to load impedance.
 Noise Level: Equivalent input noise: -126 dbm (valid for unterminated input operation).
 Power Supply: 15ma at 275vdc and .7a at 6.3vdc.
 Tubes: 2—6072/12AY7.
 Dimensions: $1\frac{3}{4}$ " W x $3\frac{1}{16}$ " H and $9\frac{1}{16}$ " L when mounted in tray.
 Color: Cadmium plate with dichromate dip
 Weight: $3\frac{1}{2}$ lbs. (including tray).
 Special Features: Push buttons for individual tube test.
 40ma dc can be applied to input or output transformer center taps for simplexing use.
 Accessories: 13225 Rack Mounting Assembly (accommodates 9 units).
 13401 Mounting Tray Assembly.
 5981 Tube Test Meter.
 535A Power Supply.

459A PROGRAM AMPLIFIER



SPECIFICATIONS:

Gain: 56 db unterminated input, 50 db terminated.
 Power Output: $+30$ dbm at less than .5% THD 30 to 20,000 cps.
 $+35$ dbm at less than 1% THD at 1 KC.
 Frequency Response: ± 1 db 20 to 20,000 cps.
 Source Impedance: 150 or 600 ohms (centertap available when connected for 600 ohms).
 Load Impedance: 150 or 600 ohms (centertap available when connected for 600 ohms).
 Noise Level: Equivalent input noise: -126 dbm (valid for unterminated input operation).
 Power Supply: 40ma at 275vdc and 1.6a at 6.3vdc.
 Tubes: 1—6072/12AY7, 2—12BH7.
 Dimensions: $1\frac{3}{4}$ " W x $3\frac{1}{16}$ " H x $9\frac{1}{16}$ " L when mounted in tray.
 Color: Cadmium plate with dichromate dip
 Weight: $3\frac{1}{2}$ lbs. (including tray).
 Special Features: Push buttons for individual tube test.
 40ma dc can be applied to input or output transformer centertaps for simplexing use.
 Accessories: 13225 Rack Mounting Assembly (accommodates 9 units).
 13401 Mounting Tray Assembly.
 5981 Tube Test Meter.
 535A Power Supply.

535A POWER SUPPLY



SPECIFICATIONS:

Power Output: 275vdc at 275ma.
 At 275ma ripple is .02v peak to peak max.
 6.3vdc at 13a.
 At 13a ripple is 1.5v peak to peak max.
 Power Input: 117v 50-60 cps 245 watts at full load.
 Rectifiers: Silicon.
 Controls: 1. Power Switch
 2. Circuit Breaker (Push to reset)
 3. 4 position tap switch (provides adjustment of voltage by autoformer action to accommodate 2 to 1 range of loads).
 Color: Dark Green.
 Weight: 16 pounds.
 Size and Mounting: $7\frac{3}{16}$ " W x $9\frac{5}{8}$ " H x 7" D overall.

planning information

By completing the form below, the purchaser is assured of ordering the full complement of components to provide all facilities for the particular console.

ITEM	QUANTITY
1. 250 SU Basic Altec Console	1
2. 535A Power Supply	1
3. 458A Preamplifiers	
(a) One for each microphone or low level input (10 max.)	
(b) One for each channel (3 max.)	
4. 459A Program Amplifier (2 max.)	
One for single line/single or dual channel operation. Two for "stereo" or two channel/two line operation.	
5. 13387 Utility Input Device	
One for each high level input. Sum of 3 (a) above and 5 cannot exceed 10.	
6. 7160 V.U. Meter	
For second channel. Add for "stereo" or two line operation.	
7. 5981 Tube Test Meter	
8. Altec Monitor Amplifier	
Use as separate accessory.	

Preamplifiers, program amplifiers, power supplies & accessories

The 7160 V. U. Meter is an exact duplicate of the meter furnished in the 250 SU Altec Control Console, and mounting space is adjacent to the meter furnished. Meter illuminating lamps and mounting facilities and pads are part of the 250 SU Console so no special tools are required for installation or connection of the meter. A second meter is required for "stereo" or two-channel/two-line operation.

The 13387 unit is a Utility Input Device for high level input sources. This is an isolation transformer built on a "plug-in" chassis of the same size and dimensions as the 458A Altec "Plug-in" Preamplifier, and is designed for insertion into the standard 13401 Mounting Tray Assembly. Type 13387 is for "bridging" a 150 or 600 ohm line or matching a 15,000 ohm line. The unit is cadmium plated with a dichromate dip and weighs 1 pound.

The 5981 Tube Test Meter is an accessory to the 250 SU Altec Control Console unit. It is used to visually test the tube condition of the tubes used in the "plug-in" amplifiers type 458A and 459A. Mounting provisions and wiring for the meter are inside the console, located in the right rear section. No special tools are required for mounting. When installed, the meter provides, in addition, an indication of heater voltage by means of a push button switch and suitable shunt which is a standard part of the console.

RACK MOUNTING FACILITIES

The 13225 is available for use in rack mounting of speech input equipment. The rack mounting assembly is drilled to accept nine type 13401 Mounting Tray Assemblies for use with Altec 458A and 459A "Plug-in" Amplifiers and Altec 13387 Utility Input Device.

The 13225 assembly is for standard 19" rack or equipment cabinet mounting and occupies only 5 1/4" of panel space. The assembly has a "Snap-in" removable front cover for instantaneous access to the units for test or service. The finish of the front cover is Dark Green, and the complete assembly weighs 4 pounds.

For rack mounting 535A Power Supply, 10440 10 1/2" Blank Panel may be used or Power Supply may be mounted on wall of equipment cabinet.

The 13401 is furnished as part of the 250 SU Altec Control Console, however, it is available separately to provide mounting and "plug-in" connection facilities for 458A and 459A Altec "Plug-In" Amplifiers or the 13387 Utility Input Device, when mounted in the 13225 Rack Mounting Assembly. The 13401 finish is cadmium plate with dichromate dip. The tray assembly is complete with "mating" female receptacle to accept the 458A, 459A and 13387 units. The tray measures 1 3/4" W x 7/8" H x 9" L (over terminals), and weighs 1/2 pound.

7160
V.U. METER



13387
UTILITY
INPUT
DEVICE



5981
TUBE TEST METER



13225
RACK MOUNTING ASSEMBLY



13401
MOUNTING
TRAY
ASSEMBLY



performance

458A PREAMPLIFIER

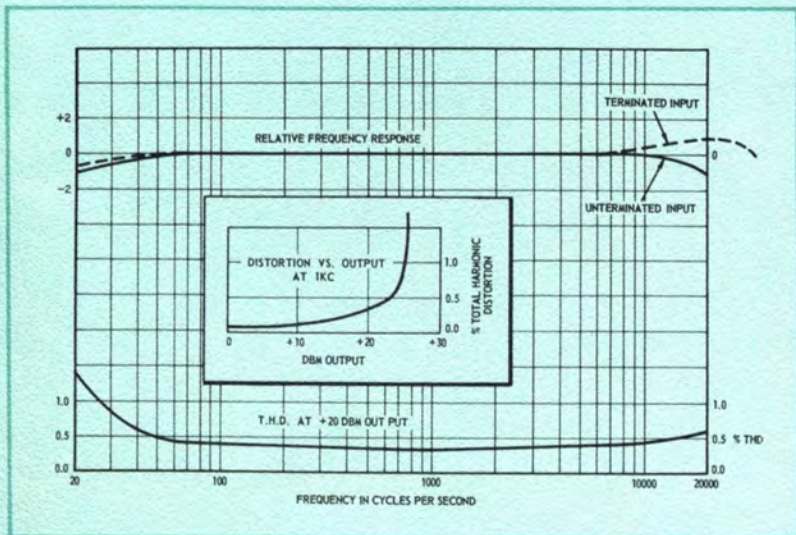

459A PROGRAM AMPLIFIER

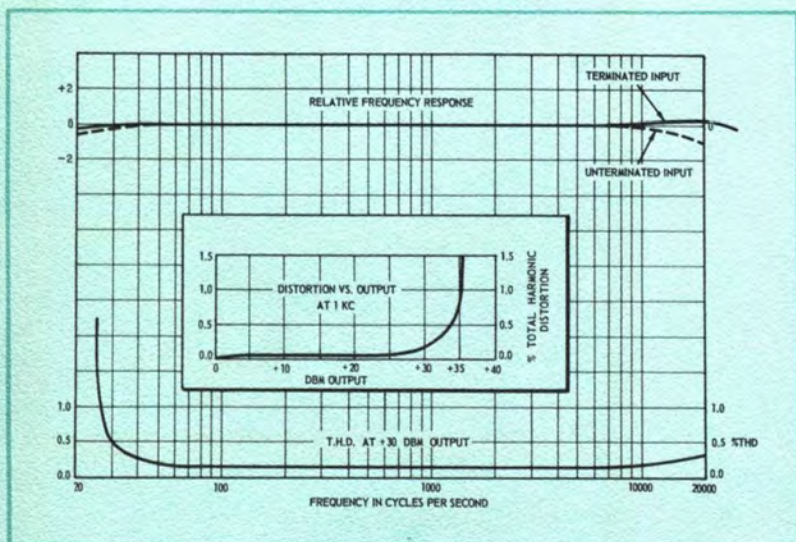

PRODUCTS OF QUALITY

features 250SU

- EXCEEDS NAB, EIA, AND RECORDING REQUIREMENTS
- "PLUG-IN" AMPLIFIERS
- LOW IMPEDANCE MIXING
- SPEECH-MUSIC FILTER
- D.C. HEATER SUPPLY
- UNTERMINATED MICROPHONE INPUTS
- UTILITY INPUT DEVICES FOR TAPE—DISC—LINE—NETWORK—ETC.
- TUBE TESTING PROVISIONS
- EXPANDABLE TO JACK FIELDS, EQUALIZERS, ETC.
- SINGLE CHANNEL OPERATION
- TWO CHANNEL OPERATION
- TWO CHANNEL/THREE CHANNEL OPERATION
- "STEREO" OPERATION
- ILLUMINATED METERS
- COLOR CODED CONTROLS
- INPUT NOISE APPROACHING "THEORETICAL"
- CENTER TAP FOR SIMPLEXING INPUT SIGNALS
- 16 CONNECTED INPUTS
- MICROPHONE LEVEL OR "HIGH LEVEL" ON ANY INPUT

technical data 250 SU console

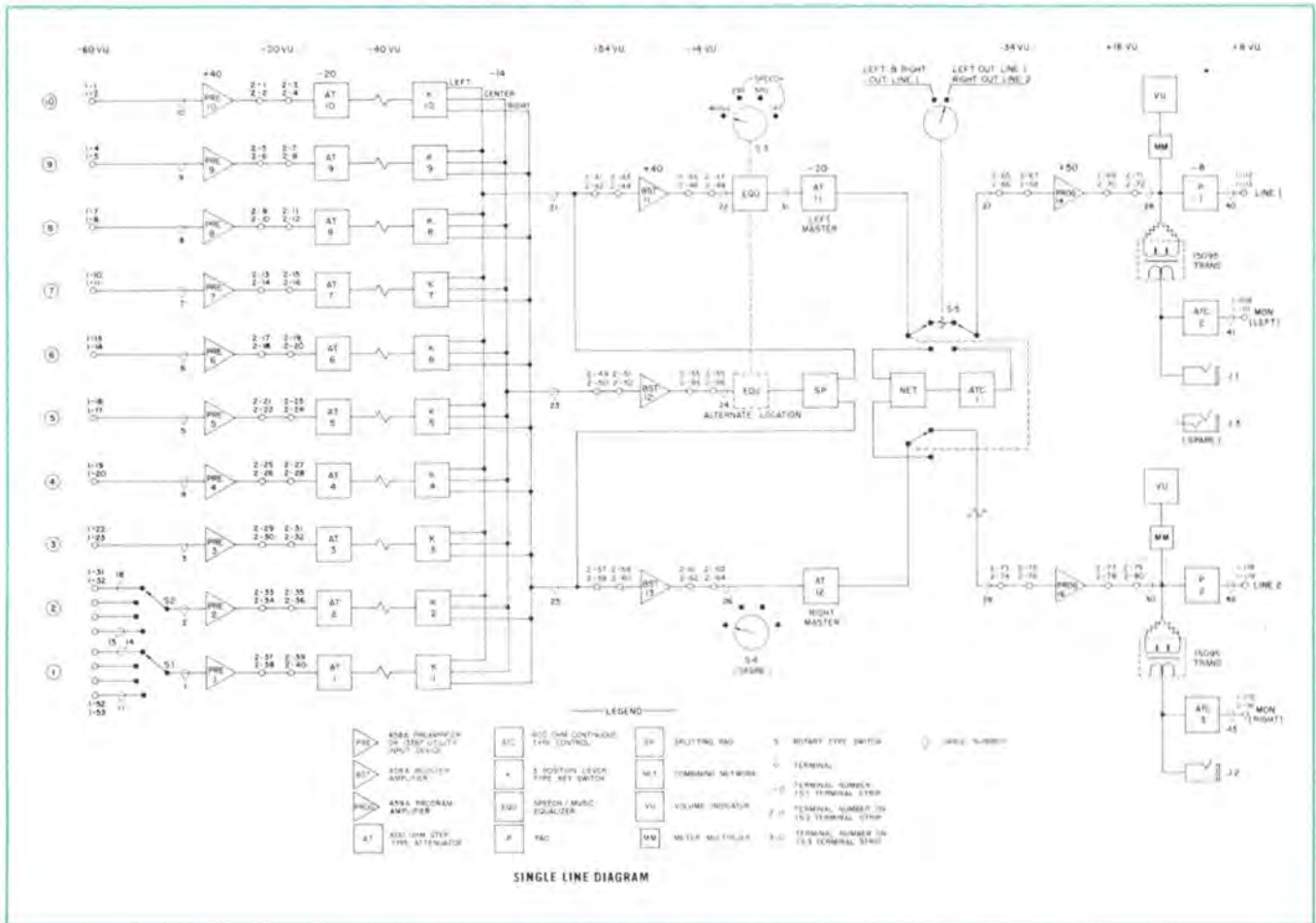

specifications

Microphone Input to Line Output

Gain: 98db (Includes 6 db line isolation pad)

Frequency Response: ± 1 db 30 to 15,000 cps.

Distortion: 0.5% 30 to 15,000 cps. at output level of +20dbm and less than 1% at +24 dbm.

Signal to Noise Ratio: 70 db (+18 dbm output with -50 dbm input)

High Level Channels

Gain: 41 db

Frequency Response: ± 1 db 30 to 15,000 cps.

Distortion: 0.5% 30 to 15,000 cps. at +20 dbm output and less than 1% at +24 dbm output.

Signal to Noise Ratio: 70 db (18 dbm output with -10 dbm input)

Source Impedances

Microphone Inputs: 150 or 600 ohms

Line or Utility Inputs: Up to 15,000 ohms

Load Impedances

Line Outputs: 600 ohms

Monitor Outputs: 600 ohms (Requires Separate Monitor Amplifiers)

Headphone Outputs: 600 ohms

Additional Specifications

VU Meters: One furnished complete with meter illuminating lamps, mounting facilities and pads. (A second meter is required for "stereo" or two-channel/two line operation. Available separately as an accessory.)

Cable

Terminations: Internally mounted WE Type L6A terminal board.

Patch Panel: All major circuits brought to jumpered terminals to provide means for wiring out jacks, if required.

Channels:

One, two or three divided to two for stereo use.

Attenuators:

Ten mixers. (All 600-ohm step type attenuators.) Two masters or two sub-masters and one board master. Two monitors.

Keys:

Ten three-position keys make each mixer attenuator selectable to three buses.

Rotary Switches:

Inputs 1 and 2 have switches providing choice of four program sources each, for utility use. (Total of 16 connected inputs.) Two-position line output switch. One additional spare provided but not wired.

Filters:

One four-position speech-music filter provided.

Headphone Jacks:

Three, two for channel monitoring. Third unwired to be used for intercom, etc.

Amplifiers:

Broadcast quality "plug-in" type. Input transformers 90 db magnetic shielding. Input and output 150 or 600 ohms balanced. Two amplifier types (Preamp & Program-amp), same physical size.

Power Supply:

Completely enclosed cube for external mounting (under table, wall, etc.) with interconnecting cable and connectors. Supplies B+ and 6.3v dc for heaters.

Panels:

Aluminum, standard Altec color with characters etched and filled. Panels may be engraved when additional markings are required.

Cabinet:

Hinged two-slope control panels painted Dark Green. Contains all equipment except power supply and monitor amplifier(s).

Dimensions:

9 1/2" H., 39 1/4" W., 16" D.

Mounting:

Table or desk, not supplied.

Accessories:

458A Plug-In Preamplifier and Booster Amplifier.
459A Plug-In Program Amplifier.
13387 Plug-In Utility Input Device for High Level Sources.
535A Power Supply.
7160 V.U. Meter for Second Channel.
5981 Tube Test Meter.

NOTICE

We recommend that you obtain your Altec products from factory trained authorized Altec Sound Contractors and Distributors. This will assure you of proper installation, a continuing source of knowledgeable advice, service, and quick warranty protection.

361A Mixer/Power Amplifier

361A



Features:

- Two Channel Mixer/Power Amplifier
- Full Range of Plug-In Accessories
- All Solid-State Design
- Transformerless Operation With 4 to 16 Ohm Loads
- Easily Installed 70-Volt Output Transformer
- Volume Compressor Optional
- 18 Watts of Power
- Frequency Response ± 1 DB, 20-20,000 CPS
- Plug-In Microphone Preamplifier, Equalized Amplifier (Phono), or Line Transformer
- Compact, Rugged Design
- Minimum Heat Generation
- Extremely Low Noise Figure
- Shelf or Rack Mounted (With Mounting Frame)

MIXER/POWER AMPLIFIER FOR:
PAGING, VOICE AND MUSIC SYSTEMS
SCHOOLS — THEATERS — HOTELS — CLUBS — FACTORIES
OFFICES — CHURCHES

The Altec 361A mixer/power amplifier is a solid-state unit designed to control, mix and amplify two independent input signals, providing 18 watts of power to 4-16 ohm loads. The 361A mixer/power amplifier provides complete versatility to meet the demands of the diverse sound distribution problems which confront the sound engineer. Equally effective with any complement of accessories, the 361A can be tailored to the needs of the small complex installations, providing professional sound at moderate cost.

Without accessories, one input may be used for a ceramic phono pick-up or a high-impedance announce microphone while the other input may be used for any high-impedance high-level device such as a radio tuner or a tape machine. Either input may be used for low-impedance 600-ohm sources.

With accessories — plug-in devices such as the 1578A microphone preamplifier, the 1579A equalized phono amplifier, or the 15095 transformer — the mixer/power amplifier will accommodate low-impedance microphones, magnetic pick-ups, balanced or unbalanced low-impedance lines, etc. The 16660 line transformer accessory provides the standard 70-volt speaker distribution system. This transformer is designed to mount on the rear of the amplifier in minutes with solderless inter-connecting links and provides a 70-volt isolated output. The performance of this transformer is such that in excess of 18 watts at less than 2% distortion is available from 40 cycles to above 15,000 cycles. An additional accessory, the 14678A volume compressor assembly can be mounted on the rear panel where a socket has been provided for proper connection to the amplifier circuitry.

The power supply of the 361A mixer/power amplifier is equipped with self-resetting circuit breakers in the primary and the secondary transistor supply circuits to provide maximum component protection in the event of inadvertent speaker line short circuit, inadequate ventilation or other abnormal operating conditions.

The Altec 361A mixer/amplifier measures only 4 $\frac{3}{4}$ " high, 13 $\frac{1}{8}$ " wide and 8 $\frac{1}{16}$ " deep. The front panel is functionally designed and includes two-color appearance with control knobs having brushed aluminum inserts. Overall illumination of the front panel is provided by indirect means. For rack mounting applications the Altec 14965 rack mount assembly permits the 361A to be rack mounted using only 5 $\frac{1}{4}$ " of vertical rack space.



A Division of *LS* Ling Altec, Inc.

1515 S. Manchester Ave., Anaheim, Calif.
New York

INPUT ACCESSORIES

The plug-in accessories for the input circuits of the mixer/power amplifier are carefully designed units, using solid-state circuitry for rugged dependable operation and high quality performance. These plug-in accessories make the proper input circuit instantly available for rapid installation permitting use of a wide range of input devices. Sockets on the rear of the mixer/power amplifier are pre-wired for the proper operating voltage and circuit connections, allowing the various plug-in accessories to be interchanged without rewiring, circuit or component changes and to be used in any combination to match properly, all commonly used input devices. The following descriptions are provided to explain the functions and performance of each of them.

1578A MICROPHONE PREAMPLIFIER

The 1578A microphone preamplifier is designed with a gain of 33.5 db. Sensitivity is 43 millivolts rms for an output of +8 dbm. Frequency response is ± 0.5 db, 20-20,000 cps, or, ± 1.5 db, 15-50,000 cps. Source impedance is 150 ohms nominal, usable 30 to 20,000 ohms. Equivalent input noise is -122 dbm. The 1578A requires 12 vdc at 13 ma. The 1578A microphone preamplifier may be used with any high quality low-impedance microphone.

1579A PHONO EQUALIZED PREAMPLIFIER

The 1579A phono equalized preamplifier is specially designed for magnetic phono pick-ups to meet the RIAA standard. Sensitivity is 5 millivolts for 70 millivolt output at 1 kc. Output is +8 dbm at less than 0.5% thd (total harmonic distortion). Input impedance is 47,000 ohms and the power required is 12 vdc at 11 ma. Figure 1 illustrates the performance of the 1579A as referenced to the RIAA standard.

15095 LINE TRANSFORMER

The 15095 line transformer may be used as a bridging transformer for bridging a balanced 600 ohm line. The 15095 has 30 db of electro-magnetic shielding and a frequency response of ± 1 db, 30-20,000 cps. The 15095 line transformer may also be used to perform a terminating function rather than a bridging function by the addition of a proper terminating resistor at the input of the mixer/power amplifier.

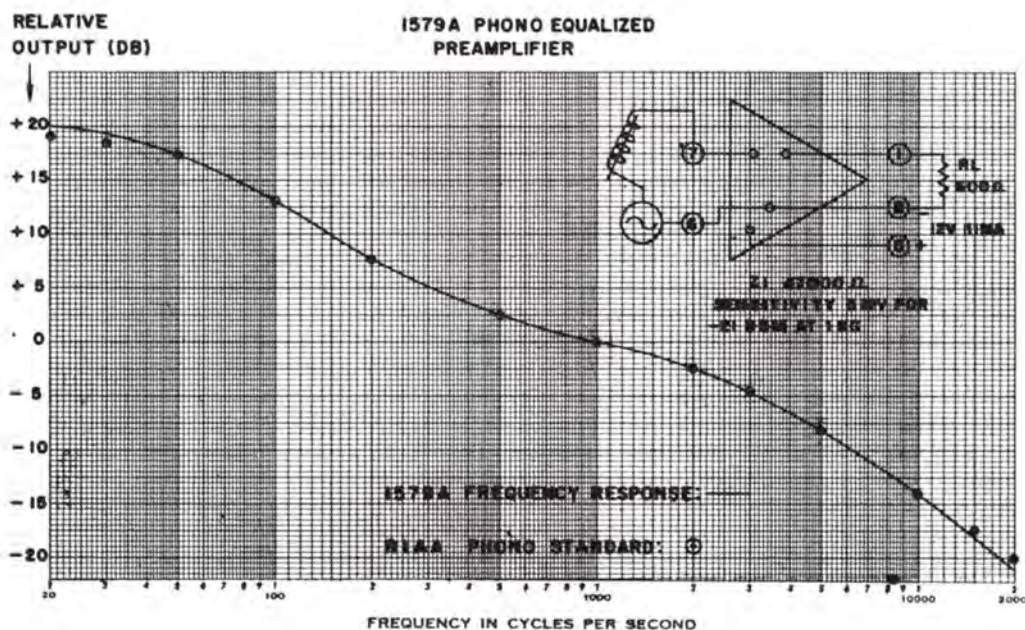
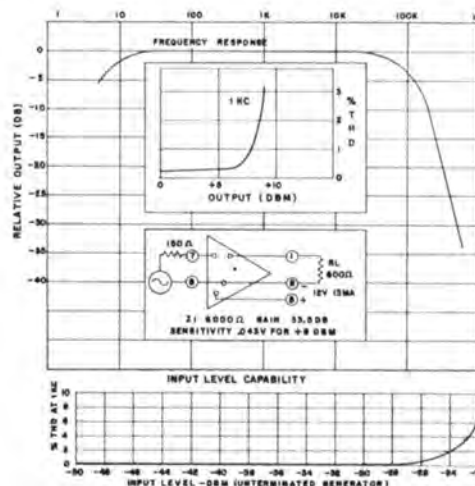

FIGURE 1

ADDITIONAL ACCESSORIES 16660 OUTPUT TRANSFORMER

The output of the 361A mixer/power amplifier is transformerless and, therefore, one side of the output is at ground potential. The Altec 16660 70-volt output transformer has been provided for standard speaker distribution systems where a balanced line is required. The 16660 transformer mounts on the rear of the 361A mixer/amplifier without soldering and no additional hardware other than that supplied with the amplifier is required. The performance of this transformer is such that in excess of 18 watts at less than 2% distortion is available from 40 cycles to above 15,000 cycles.



14965 RACK MOUNTING ASSEMBLY

When rack mounting of the 361A mixer/power amplifier is desired, the 14965 rack mounting assembly has been provided as an accessory. The rack mounting assembly includes a front panel for the amplifier which maintains the pleasing appearance and allows the rack to be pressure ventilated if associated equipment requires it. Rack mounted, the 361A will occupy 5 1/4" of vertical rack space and the front panel is painted Altec Green.

14678A VOLUME COMPRESSOR ASSEMBLY

The volume compressor is rear mounted and is connected to the circuitry of the 361A mixer/power amplifier by means of a six-pin plug attached to the compressor assembly. A knob on the rear of the compressor assembly controls the compression threshold and is adjustable in steps of 2, 4, 8, 16 and off. The numbers correspond to approximate power output in watts. The compressor is rapid acting having an attack time of 10 milliseconds and has a compression ratio above threshold of better than five to one.

361A AMPLIFIER CAPABILITY WITH ACCESSORIES

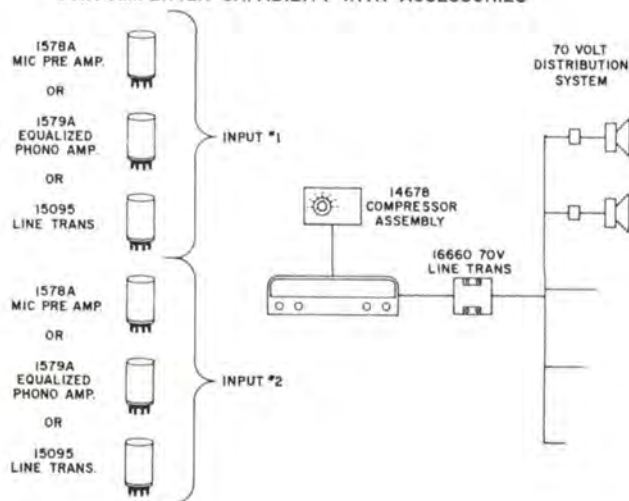

361A AMPLIFIER CAPABILITY WITHOUT ACCESSORIES

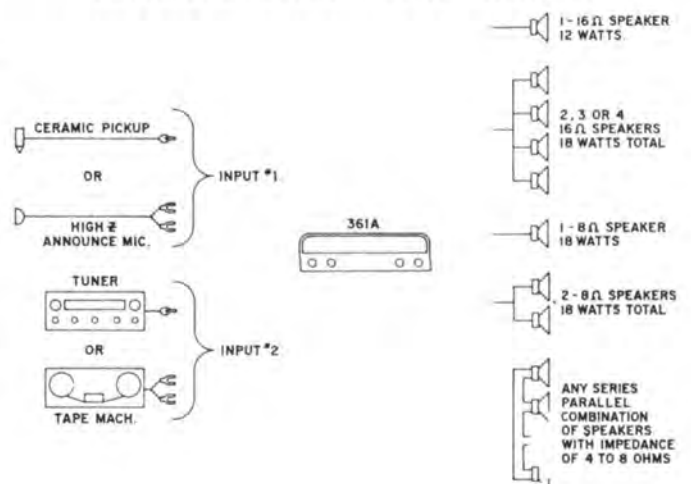

SPECIFICATIONS

Type:	Two channel transistor mixer/power amplifier with plug-in options.	Controls:	2 mixer, 1 tone, 1 power switch on front panel, 1 selector switch for high-impedance microphone or ceramic phono pickup on rear panel*, 1 balance control, internal.
Gain:	100 db into high-impedance microphone input. *117 db with 1578A plug-in microphone pre-amplifier. *67 db with 15095 plug-in transformer bridging 600-ohm line.	Power Supply:	117 volts, 50-60 cps (10 watts at zero signal, 28 watts at 1/2 output, and 42 watts at full power).
Input Sensitivity:	700 mv rms 18 watts output, ceramic phono pick-up. *500 mv rms for 18 watts output, tuner input. *0.5 mv (1 kc) for 18 watts output, with 1579A equalized plug-in amplifier for magnetic phono pick-up.	Dimensions:	4 3/4" H x 13 1/8" W x 8 1/4" D.
Power Output:	25 watts mid-band at less than 2% thd, 4 to 6 ohm loads and 70-volt line, 18 watts at less than 2% thd, 30 to 15,000 cps, 4 to 8 ohm load, 18 watts at less than 2% thd, 40 to 15,000 cps, 70-v line, 12 watts at less than 2% thd, 45 to 12,000 cps, 16 ohm load.	Color:	Altec Green.
Frequency Response:	±1 db from 10 to 30,000 cps.	Weight:	10 lbs.
Input Impedance:	Direct input to mixer pots, 600 ohms nominal (unbalanced), Tuner input, 30,000 ohms.	Accessories:	1578A transistor preamplifier, plug-in (microphone). 1579A equalized transistor preamplifier, plug-in (magnetic phono). 14678 Compressor assembly and 14722 bracket, plug-in connection. 15095 transformer, plug-in (high-level balanced line to mixer). 16660 transformer for 70-volt line (mounts internally from rear with 6 screws for mechanical and electrical connections).
Source Impedance:	20,000 ohms high-impedance microphone input (channel 1 only), Ceramic phono input (channel 1 only), Up to 50,000 ohms, tuner input (channel 2 only), 150 ohms nominal with 1578A accessory pre-amplifier (channel 1 or 2), Up to 50,000 ohms with 1579A accessory magnetic phono amplifier (channel 1 or 2), 600 to 15,000 ohms with 15095 accessory transformer (channel 1 or 2).		*Indicates the ceramic phono-hi z Microphone switch, which functions as a high-low gain switch when plug-in accessories are used, is in the HI Z MIC position. Approximately 5.5 db of attenuation is available when the switch is in the CER PHONO position.
Load Impedance:	4/8/16 ohms. 275 ohms, ungrounded, with 16660 (70-v) transformer.	Ordering Information:	Order one 361A amplifier plus the following: If 70-volt line output is required order one 16660 transformer. If volume compressor is required, order one 14678A assembly with 14722 mounting bracket. If accessory inputs are to be used, order any combination of the following: (two maximum may be used at any one time.) 1578A transistor preamplifier plug-in (microphone). 1579A equalized transistor phono preamplifier for magnetic phono pick-up. Plug-in. 15095 transformer plug-in (high level balanced line to mixer). If rack mounting of the 361A mixer/power amplifier is desired, order one 14965 rack mounting assembly. (Requires 5 1/4" of rack space.)
Load Voltages:	8.5/12/14 volts. 70 volts, ungrounded, with 16660 transformer.		
Noise Level:	Equivalent input noise — -119 dbm with 1578A preamplifier, Output noise — -30 dbm with mixer controls closed (8 ohm load).		

ARCHITECTS AND ENGINEERS SPECIFICATIONS

The mixer/amplifier shall be self-contained and shall employ all solid-state devices. Without accessories, the mixer/amplifier shall be capable of mixing two independent input signals originating from either a ceramic phono pick-up, high-impedance microphone or equivalent, and from either a radio tuner, tape machine or equivalent. Either of the two inputs shall be capable of accepting 600-ohm low-impedance sources. Input connections shall be made in one of two ways; direct connections to terminal strips provided for the separate inputs, or, standard phono plugs for the high-impedance input, magnetic phono input and the tuner input. The mixer/amplifier shall have separate volume controls on each input and shall have a treble tone control common to both inputs. In addition, each input shall have a socket provided for the use of various types of plug-in accessories, enabling the mixer/amplifier to accept signals from low-impedance sources, magnetic type pick-ups and bridged low-impedance lines.

The mixer/amplifier shall have a frequency response of ±1 db, 10-30,000 cps, and shall deliver 18 watts at less than 2% thd, (total harmonic distortion), 30-15,000 cps, to a 4/8 ohm load. The output of the mixer/amplifier shall be of the transformerless type, capable of delivering 25 watts into loads ranging from 4 to 6 ohms. The output shall be capable of operating a 70-volt transformer for standard speaker distribution systems, and the 70-volt transformer accessory, specified elsewhere, shall be mounted on the rear of the mixer/amplifier and shall connect to the mixer/amplifier without the need of soldering, utilizing interconnecting links supplied with the transformer.

The mixer/amplifier shall provide operating voltages and a connecting socket for a compressor assembly accessory, specified elsewhere, which may be mounted to the rear of the unit, to provide volume compression when required.

The mixer/amplifier shall have a self-contained power supply, operating from 120 vac, (requiring no more than 42 watts when delivering full power), and shall have self-resetting circuit breakers in both the primary and the transistor supply circuits. Fuse or manual resetting devices are not acceptable.

The mixer/amplifier shall measure no more than 4 3/4" high, 13 1/8" wide, and 8 1/4" deep. It shall weigh no more than 10 pounds and shall be dark green in color.

There shall be available, as a plug-in accessory to the mixer/amplifier, a transistor preamplifier with a nominal 150-ohm source impedance, usable 30-20,000 ohms. Frequency response shall be ±0.5 db, 20-20,000 cps, or, ±1.5 db, 15-50,000 cps. The transistor plug-in preamplifier shall have a gain of 33.5 db and sensitivity shall be 43 millivolts for an output of +8 dbm. The plug-in transistor preamplifier shall allow any high-quality low-impedance microphone to be used with the mixer/amplifier.

There shall be available, as a plug-in accessory to the mixer/amplifier, a phono equalized transistor amplifier which shall meet the RIAA standard. Sensitivity shall be 5 millivolts for 70-millivolt output at 1 kc. Output shall be +8 dbm at less than 0.5% thd (total harmonic distortion). Input impedance shall be 47,000 ohms and power required shall be 12 vdc at 11 ma.

Any mixer/amplifier and plug-in accessories not meeting the above specifications shall be deemed unacceptable under this specification.

The mixer/amplifier shall be Altec Lansing model 361A.

The transistor preamplifier shall be Altec Lansing model 1578A.

The phono preamplifier shall be Altec Lansing model 1579A.

PLAYBACK *and speech-input* **equipment**
 for recording and broadcast studios

ALTEC
 AMPLIFIERS
 AND
 PREAMPLIFIERS



1567A MIXER AMPLIFIER

The 1567A is designed for remote broadcast and recording applications when installed in portable carrying case. Without case, the 1567A can be rack mounted or mounted in table top consoles, either singly for monophonic use or in pairs for stereo pickup. Features hinged front panel for immediate internal access without interrupting program connections, non-glare panel with write-in strips for pickup identification. An additional output, not effected by tone and master controls, provides signal for tape recorders.

ENGINEERING SPECIFICATIONS

<p>GAIN: 97 db max. Channels 1, 2, 3, 4 55 db max. Channel 5 (17 mv input for 0 dbm output)</p> <p>POWER OUTPUT: +18 dbm or 50 v open circuit</p> <p>FREQUENCY RESPONSE: ±1 db 30-15,000 cps</p> <p>INPUT IMPEDANCE: 1 megohm, Channels 1, 2, 3, 4; .25 megohm Channel 5</p> <p>SOURCE IMPEDANCE: 30/50 and 120/200 ohms Channels 1, 2, 3, 4 with 4722 plug-in microphone transformer</p> <p>LOAD IMPEDANCE, LINE OUTPUT: 15,000 ohms to infinity 150 and 600 ohms with 15095 plug-in line transformer</p> <p>LOAD IMPEDANCE, RECORDER OUTPUT: 270,000 ohms and 100 mmf. max.</p> <p>NOISE LEVEL: Equivalent input noise — 123 dbm Output noise — 68 dbm with master gain control closed</p>	<p>CONTROLS: 5 mixer, master, bass, treble and illumination controls, VU range, power switch</p> <p>POWER SUPPLY: 117 volts, 60 cps, 20 watts</p> <p>EXTERNAL POWER AVAILABLE: 117 volt ac receptacle on chassis</p> <p>TUBES: 3 — 12AX7, 1 — 6CG7</p> <p>DIMENSIONS: 5¼" H x 19" W x 6¾" D (less portable case)</p> <p>COLOR: Dark green</p> <p>WEIGHT: 10¾ lbs.</p> <p>ACCESSORIES (ORDER EXTRA): 12862 VU Meter Assembly 12864 Plug-in RIAA Phono Equalizer Assembly 12863 XL Connector Assembly 12866 Portable Carrying Case 4722 Plug-in Microphone Input Transformer 15095 Plug-in Output Line Transformer</p>
--	--



1566A PREAMPLIFIER

For TV and radio broadcast, and recording applications requiring a separate high-quality preamplifier with self-contained AC power supply for each microphone, the Altec 1566A is unhesitatingly recommended. With the addition of the Altec 15095 and/or 4722 transformers, the 1566A will accept all low impedance microphones, together with standard 150 and 600 ohms lines; both the line and the direct output of the unit are available simultaneously. A cathode follower stage, together with two stages of amplification, provide a gain of 65 db and an output level of +10 dbm, suitable for virtually all applications.

ENGINEERING SPECIFICATIONS

<p>GAIN: 65 db maximum</p> <p>POWER OUTPUT: +10 dbm or 18 v (rms) open circuit</p> <p>FREQUENCY RESPONSE: ±1 db 30-15000 cps</p> <p>INPUT IMPEDANCE: 100,000 ohms</p> <p>SOURCE IMPEDANCE: 30/50 and 120/200 ohms with 4722 plug-in microphone transformer</p> <p>LOAD IMPEDANCE: 15,000 ohms to infinity. 150 and 600 ohms with 15095 plug-in line transformer.</p> <p>NOISE LEVEL: Equivalent input noise — 120 dbm. Output noise — 81 dbm with gain control closed.</p> <p>CONTROLS: Gain and power</p> <p>POWER SUPPLY: 117 volts, 60 cps, 5 watts</p> <p>EXTERNAL POWER AVAILABLE: 117 volt AC receptacle on chassis</p> <p>TUBES: 2 — 12AX7</p> <p>DIMENSIONS: 1¾" H x 19" W x 7" D (rack mounting) 1¾" H x 11⅛" W x 7¼" D (wall mounting)</p> <p>COLOR: Dark green</p> <p>WEIGHT: 5½ lbs.</p> <p>ACCESSORIES: 4722 Plug-in microphone transformer 15095 Plug-in transformer 13033 Phono Equalizer Assembly</p>
--

If You Didn't Get This From My Site,
 Then It Was Stolen From...



128B POWER AMPLIFIER

The 128B is a general purpose transcription amplifier of very high quality and reliability which will fill many needs in the recording studio and broadcast station. The 128B features full tube metering facilities and the exclusive Altec Thermeguard incorporated within the transformer windings providing complete protection from potential malfunctions caused by extraneous influences such as tube shorting, component failure, or other circuit defects. Thermeguard automatically reduces the line current drawn by the 128B, proportionately, until the malfunction is corrected.

ENGINEERING SPECIFICATIONS

GAIN: 64 db. **INPUT SENSITIVITY:** 0.9 volt rms. **POWER OUTPUT:** 40 watts at less than 2 THD, 30-20,000 cps. **FREQUENCY RESPONSE:** ± 1 db 3-30,000 cps. **INPUT IMPEDANCE:** 100,000 ohm potentiometer. **SOURCE IMPEDANCE:** 150 and 600 ohms with 15095 Plug-in Line Transformer. **LOAD IMPEDANCE:** 4 (12.6 v.), 8 (18 v.), 16 (25 v.), 125 (70 v.) ohms ungrounded. **OUTPUT IMPEDANCE:** Less than 17% of nominal load impedance. **NOISE LEVEL:** 85 db below rated output. **CONTROLS:** Front Panel — Volume

Control, Continuously variable composition, Power and Meter Selection Switch; Chassis — Line Voltage Selection Switch and High Pass Filter Switch, both with locking plates. **POWER SUPPLY:** 105/125 volts, 50/60 cps, 125 watts. **TUBES:** 2 - 6CG7, 2 - 6CA7/EL34, 1 - 5AR4. **DIMENSIONS:** 8 $\frac{1}{4}$ " High, 19" Wide, 7" Deep. **COLOR:** Dark Green. **WEIGHT:** 27 lbs. **SPECIAL FEATURES:** High Pass Filter for protection of horn-loaded drivers.



436C COMPRESSOR AMPLIFIER

The 436C is designed for input circuit applications in both recording studios and broadcast stations. For the recording studio the 436C automatically maintains a high recording level without danger of over-modulation on peaks with resultant distortion; in the broadcast station it automatically provides a higher level of modulation and reduces the tendency to over-modulate with resultant generation of side band splatter. The features of the 436C are variable threshold, compression ratio and release (recovery) time controls, providing the recording or broadcast engineer complete control.

ENGINEERING SPECIFICATIONS

TYPE: Compressor Amplifier. **GAIN:** 56 db from 15,000 ohm source; 40 db bridging 600 ohm line. **FREQUENCY RESPONSE:** ± 1.5 db, 30-15,000 cycles. **POWER OUTPUT:** +24 dbm (as straight amplifier). **HARMONIC DISTORTION:** At 25 db of compression: less than 1.5%, 35-15,000 cycles; At 30 db of compression: less than 2.5%, 25-10,000 cycles. (0 db threshold setting). **NOISE LEVEL:** 74 db below rated output (-111 dbm equivalent input noise). **INPUT IMPEDANCE:** 15,000 ohms bridging transformer (ungrounded). **SOURCE IMPEDANCE:** Any up to 15,000 ohms. **LOAD IMPEDANCE:** 150/600 ohms. **MAXIMUM COMPRESSION:** 30 db. **ATTACK TIME:** 50 milliseconds. **RELEASE**

TIME: Adjustable: .3 seconds to 1.3 seconds (63% recovery). **THRESHOLD:** Adjustable: 0 dbm to +16 dbm output. **COMPRESSION RATIO:** 2:1 at 0 dbm threshold; 4:1 at +16 dbm threshold. **CONTROLS:** Input gain control, Threshold control, Release time control, AC power switch. **POWER SUPPLY:** 117 volts, 60 cycles, 20 watts. **TUBES:** 6BC8, 6CG7, 6AL5. **DIMENSIONS:** 19" long; 3 $\frac{1}{2}$ " high; 6" deep. **COLOR:** Dark green. **WEIGHT:** 8 $\frac{1}{2}$ lbs. **SPECIAL FEATURES:** Compression meter; shaft locks for threshold and recovery time controls. **ACCESSORIES:** 12495 Cabinet, 6049 Meter.



438C COMPRESSOR AMPLIFIER

Broadcast and recording engineers may find unique applications in the studio plant for the 438C Compressor Amplifier which is the same as the 436C except that it incorporates an additional stage of amplification to provide a low impedance microphone input and gain control. The overall gain of the 438C is 90 db from microphone input, 40 db from bridging 600 ohm line.

ENGINEERING SPECIFICATIONS

TYPE: Compressor Amplifier. **GAIN:** 90 db from microphone input; 40 db bridging 600 ohm line. **FREQUENCY RESPONSE:** ± 1.5 db 40-10,000 cycles. **POWER OUTPUT:** +24 dbm as straight amplifier. **HARMONIC DISTORTION:** At 25 db of compression: Less than 1.5%, 35 to 15,000 cycles; At 30 db of compression: Less than 2.5%, 35 to 10,000 cycles (0 db Threshold Control setting). **NOISE LEVEL:** Gain control at maximum: -119 dbm equivalent input noise, microphone input; Gain control at minimum: -50 dbm output noise level. **INPUT IMPEDANCE:** Bridging: 20,000 ohms, unbalanced. **SOURCE IMPEDANCE:** Microphone input: 30/50 ohms. **LOAD IMPEDANCE:** 150 and 600 ohms.

MAXIMUM COMPRESSION: 30 db. **ATTACK TIME:** 50 milliseconds. **RELEASE TIME:** Adjustable: .3 seconds to 1.3 seconds (63% recovery). **THRESHOLD:** Adjustable: 0 dbm to +16 dbm output. **COMPRESSION RATIO:** 2:1 at 0 dbm threshold; 4:1 at +16 dbm threshold. **CONTROLS:** Gain, Threshold, Release Time, AC Power Switch. **POWER SUPPLY:** 115 volts, 60 cycles. **POWER CONSUMPTION:** 22 watts. **TUBES:** 12AY7, 6BC8, 6CG7, 6AL5. **DIMENSIONS:** 19" L; 3 $\frac{1}{2}$ " H; 6" D. **COLOR:** Dark Green. **WEIGHT:** 8 $\frac{1}{2}$ lbs. **SPECIAL FEATURES:** Compression meter; shaft locks for Threshold and Release Time Controls. **ACCESSORIES:** 12495 Cabinet, 6049 Meter.

470A AMPLIFIER

470A

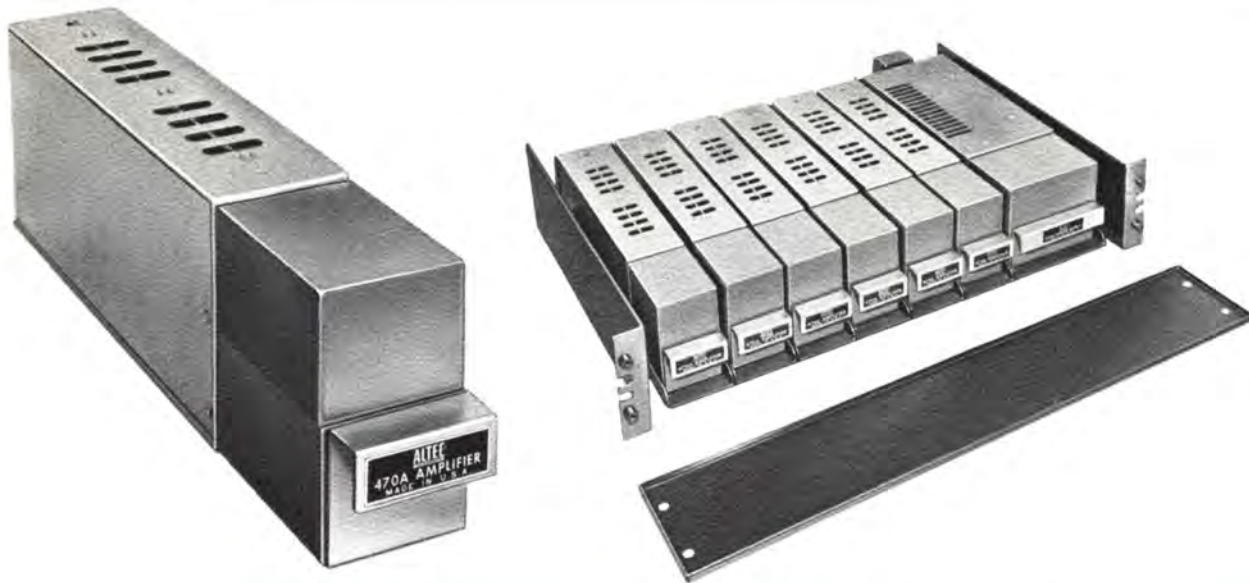

Features:

Designed to perform as:
Line, Booster, Program
or Pre-amplifier

Modern — All Silicon
Solid-State Design

Surpasses Specifications
of Tube Types

Frequency Response:
20-20,000 cps, ± 5 db!

Low Distortion

Inputs and Outputs
Completely Isolated

Astatically Balanced
Transformers

Low Heat Generation

Only 130 ma Required for
Full +27 dbm Output

Rugged—Compact—Fully
Enclosed Construction

Lightweight
Plug-in Design

SURPASSES RECORDING AND BROADCAST STANDARDS DESIGNED FOR:

RECORDING, MOTION PICTURE STUDIOS — AM, FM, &
TELEVISION STUDIOS — SCHOOLS — LABORATORIES — THEATERS
PUBLIC ADDRESS "PROGRAM CIRCUITS" — STEREO
RECORDING OF DISC, TAPE, & FILM

The Altec 470A amplifier introduces an engineering 'break-through' in solid-state professional quality amplifiers for use in recording, broadcasting and television studios. The high efficiency, extremely wide frequency response, low distortion, and virtual absence of hum and output noise enables the Altec 470A amplifier to exceed all requirements for that vital link in any first-line audio system — the pre-amplifier — delivering 0.5 watt, the 470A amplifier uses all silicon transistors which permit the amplifier to operate continuously at 85° C., (185°F.), without derating, and still provide operational stability not attainable with tube-type amplifiers. Transistor circuitry plus specially designed, astatically balanced transformers, enables the 470A to reach a noise figure of -127 dbm, with unterminated input. The total harmonic distortion does not exceed 0.25%, 50-20,000 cps when strapped for the +18 or +27 dbm output capacity, and is less than 1.0%, 20-20,000 cps, with +27 dbm output. Overload Recovery Time is 5 microseconds for 100% overload.

The Altec 470A amplifier will produce either +18 or +27 dbm, depending on external strapping. Utilizing transformers on both input and output with multiple impedance ranges, complete isolation is afforded for ease of matching the 470A to associated equipment. Fully enclosed construction insures that cross-talk is held to a minimum and is negligible even when adjacent amplifiers are operating with different signals and receive power from a common Altec 550A power supply.

Complex audio systems require the use of many different types of amplifiers to accomplish the mixing, level changing, impedance matching and amplification needed to produce the finest recording-broadcast quality. The Altec 470A amplifier has been designed — electrically and mechanically — to function as a pre-amplifier, booster amplifier or program amplifier, enabling the engineer to base his entire console design around a single amplifier type. All necessary wiring and impedance selection, via strapping, is accomplished on the 850A tray socket, allowing the 470A amplifier to be interchanged with any other 470A amplifier, regardless of its position in the circuit, without making any modifications to the amplifier or changing the channel balance or output levels. The use of Altec 470A amplifiers in this fashion makes it possible to eliminate many of the types of amplifiers needed — facilitates ease of replacement — and reduces the spare amplifiers required to one type.

The Altec 470A amplifier has been designed to meet the most rigid specifications and built under exacting standards with precision components to insure that each amplifier will not deviate in performance, but is identical in operation (within the tolerance specified) and may be used in the most critical applications where balance must be maintained between two or more amplifiers. Produced under these conditions the 470A amplifier will meet all the needs of the most sophisticated audio system, without any selection whatsoever, (as required by some manufacturers) whether used for recording, broadcasting, telecasting, specialized sound or public address systems or precision laboratory testing, and excels in performance, reliability, and trouble-free operation.



A Division of *LSPV* Ling Altec, Inc.

1515 S. Manchester Ave., Anaheim, Calif.
New York

RECORDING &

BROADCASTING

EQUIPMENT

ALTEC 470A AMPLIFIER

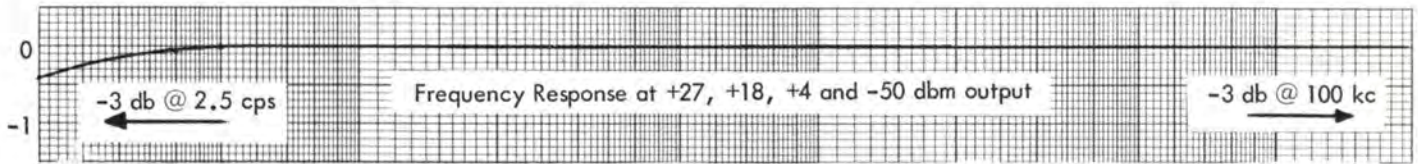

DC Input 24 vdc @ 130 ma, 3.12 watts

Noise, Unweighted
Unterminated Input = -127 dbm

Gain 45 db

Square Wave Rise Time = 2.5 microseconds, 20 cps slope, 25%

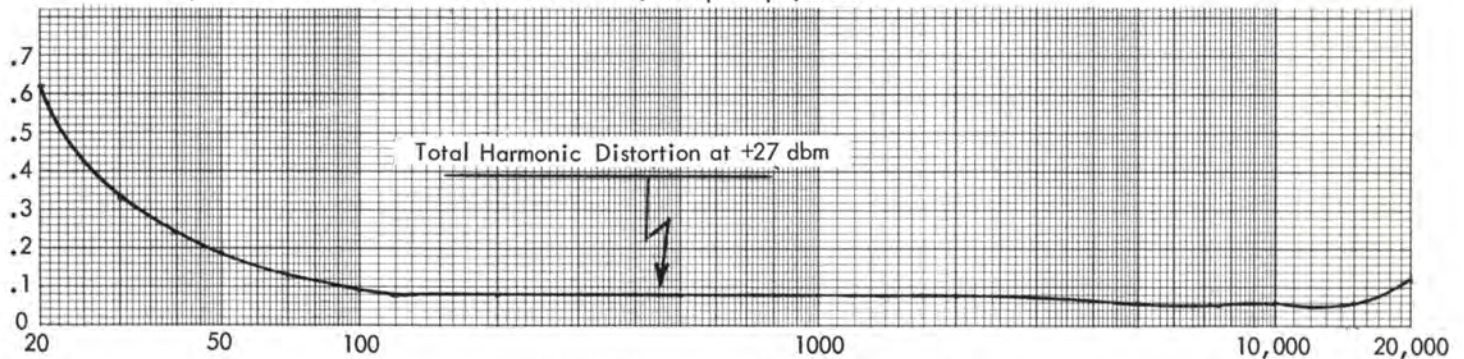

FREQUENCY IN CYCLES PER SECOND



850A MOUNTING TRAY

The Altec 850A mounting tray is an accessory for the Altec 470A amplifier and is supplied with a receptacle for mating with the plug on the rear of the 470A amplifier. All wiring required for operation of the 470A amplifier can be accomplished on the receptacle of the 850A mounting tray, allowing instant replacement of the 470A amplifier.

For rack or turret applications the 850A mounting tray is mounted on the 800A mounting frame which will accommodate eight of the 850A mounting trays. The 850A mounting tray is two inches wide, two and three-quarter inches high and twelve inches long. The tray is finished in Altec Green and weighs 11 ounces.



800A MOUNTING ASSEMBLY

The Altec 800A mounting frame is an accessory for the Altec 850A and 852A mounting trays. The 800A mounting frame is designed for rack or turret applications where space and appearance is of utmost importance. The 800A will accommodate four 852A mounting trays, (used with the 550A power supply), eight 850A mounting trays, (used with the 470A amplifier), or a combination of the two, e.g., six 850A mounting trays and one 852A mounting tray.

The 800A mounting frame is 19" wide, 3½" high, and 12¼" deep. The mounting frame is finished in Altec Green and weighs 2 pounds, 10 ounces.

550A DESCRIPTION



550A POWER SUPPLY

The Altec 550A power supply is an *all* solid-state device using silicon diodes in a full wave bridge rectifier and delivers 24 vdc at 2 amperes with excellent regulation provided by 5 silicon transistors and 3 zener diodes. The design of the 550A power supply includes an external sensing circuit to insure that the output voltage will remain constant regardless of line voltage fluctuations. Output ripple and noise is only 200 microvolts under the full two ampere load.

Capable of supplying power to 15 Altec 470A amplifiers operating with full +27 dbm output, the 550A occupies only 3" of vertical rack or turret space and is only 3 $\frac{1}{8}$ " wide. The 550A can operate continuously at 75 degrees C., (167 degrees F.), without derating any specifications including the regulation figure of 0.01%, no load to full load and/or line variation from 105 vac to 135 vac or 210 vac to 270 vac.

Complete isolation between the ac input and the dc output is afforded by the use of two connectors on the rear of the 550A power supply. The 4-pin connector, used for the ac input — either 120 vac or 220 vac — is located directly above the 6-pin connector used for the dc output and the sensing circuits. Even with the additional isolation afforded by the use of dual connectors, the convenience of plug-in operation has been retained to facilitate ease of wiring and replacement.

The output voltage of the 550A power supply is adjustable from 22 vdc to 26 vdc by means of a screwdriver adjustment on the rear of the power supply. The circuitry and components of the 550A are protected by fuses not only in each side of the ac line, but also in the regulator circuit, and are of the fast-acting type easily accessible on the rear of the unit.

As with all Altec products, only the highest grade components and finest workmanship are used in the 550A power supply to insure uniform performance and trouble-free operation.



852A MOUNTING TRAY

The Altec 852A mounting tray is an accessory for the Altec 550A power supply. The 852A tray is supplied with receptacles for mating with the plugs on the rear of the power supply. All wiring required for operation of the 550A power supply can be accomplished on the receptacles on the rear of the 852A mounting tray, allowing instant replacement of the 550A power supply.

For rack or turret applications the 852A mounting tray is mounted on the 800A mounting frame which will accommodate four of the 852A mounting trays. The 852A tray is four inches wide, three inches high and 12 inches long. The tray is finished in Altec Green and weighs 15 ounces.

550A SPECIFICATIONS:

Type:	Solid-state power supply.
Input:	120 vac, 50/60 cycles @ .75 amp, full output, or, 220 vac, 50/60 cycles @ .40 amp., full output.
DC Output:	24 vdc @ 2 amperes, regulated.
Circuit:	Full-wave bridge rectification.
Sensing Circuit:	24 vdc to the load at all times. (May be connected to remote load.)
Output Ripple and Noise:	2 ampere load = 200 microvolts rms. 1 ampere load = 75 microvolts rms.
Regulation:	0.01%, no load to full load and/or line variation of 105 to 135 vac, or line variation of 210 to 270 vac.
Output Voltage Adjustment:	Adjusted for 24 vdc when shipped. Output adjustable from 22 to 26 vdc.
Power Transformer:	Utilizes astatically balanced construction.
Fuses:	Two, 2 ampere (fast acting) in the ac line. Two, 1/2 ampere (fast acting) in the regulator circuit.
Rectifier Complement:	Four 1N3569 Silicon diodes.
Regulator Complement:	One — 1N706 zener diode. One — 1N712 zener diode. One — 1N751 zener diode. One — 2N1700 silicon transistor. One — 2N3055 silicon transistor. Three — 2N2716 silicon transistors.
Power Consumption:	70 watts at full load.
Operating Conditions:	75° C. (167° F.) maximum cabinet or turret temperature for continuous duty, without derating.
Electrical Connections:	All connections are made to a 4 and 6 pin connector on the Altec 852A tray.
Dimensions:	3 $\frac{1}{8}$ " wide, 3" high and 11 $\frac{3}{8}$ " long.
Terminals:	Plug-in.
Finish:	Light Gray baked enamel and cadmium iridited.
Weight:	6 pounds, 12 ounces.
Accessories:	Altec 852A tray. Altec 800A mounting assembly. (Accommodates 4 Altec 550A power supplies)

The Altec 550A power supply will power up to 15 Altec 470A amplifiers at +27 dbm output and up to 28 at +18 dbm output.

PERFORMANCE SPECIFICATIONS

Type:	Preamplifier, booster amplifier, or program amplifier.	Circuit:	3 stage, Class A, push-pull, direct coupled.
Gain:	45 db. (input terminated)	Operating Conditions:	85° C. (185° F.) maximum cabinet or turret temperature for continuous duty, without derating.
Frequency Response:	±0.5 db, 20-20,000 cps.	Heat Dissipation:	3.12 watts when strapped for +27 dbm output, 1.7 watts when strapped for +18 dbm output.
Source Impedance:	50, 150, or 600 ohms, balanced or unbalanced. (center tap on 600 ohms)	Dimensions:	3" high by 1¾" wide by 11" deep.
Load Impedance:	150 or 600 ohms, balanced or unbalanced. (center tap on 600 ohms)	Finish:	Light Gray baked enamel and cadmium iridited.
Output Impedance:	Less than 5% of nominal load.	Weight:	3 lbs.
Power Output:	+27 dbm maximum, 20-20,000 cps.	Electrical Connections:	All electrical connections are made to a 20-pin plug on the rear of the 470A amplifier.
Distortion:	Less than 1% total harmonic distortion, 20-20,000 cps, with +27 dbm output.	Accessories:	Altec 850A tray for mounting the 470A amplifier. Altec 800A mounting frame, accommodates eight 470A amplifiers in 850A mounting trays, or six 470A amplifiers in 850A mounting trays and one 550A power supply in an 852A mounting tray. Altec 550A power supply, designed to power up to fifteen 470A amplifiers at full output.
Noise Level: (unweighted, 10 to 25 kc band-pass)	Equivalent input noise, -127 dbm, (input unterminated).		
Overload Recovery Time:	5 microseconds for 100% overload; continuous overload will not damage the amplifier.		
Controls:	None.		
Power Requirements:	24 vdc @ 130 ma with +27 dbm output. 24 vdc @ 70 ma with +18 dbm output.		
Isolation:	Transformers on input and output.		

ARCHITECTS' AND ENGINEERS' SPECIFICATIONS

The amplifier shall be of the plug-in type, fully enclosed, and shall employ all solid-state devices, (transistors and diodes), throughout. The amplifier shall have a frequency response of ±.5 db, 20-20,000 cps, a gain of 45 db, and shall not dissipate more than 3.12 watts when delivering +27 dbm output. With an output of 0.5 watt the amplifier shall be capable of operating at 85° C. without derating. The amplifier shall employ astatically balanced transformers and shall have an equivalent noise input figure of -127 dbm with no input termination. The amplifier shall not exceed 0.25% total harmonic distortion, 50-20,000 cps with +18 or +27 dbm output and shall recover from a 100% overload in 5 microseconds.

The amplifier shall be capable of operating as a preamplifier, booster amplifier, or program amplifier without making any internal or external changes to the amplifier, and shall be capable of interchanging with any other amplifier of the same type without changing channel balance or output power settings. The amplifier shall provide complete isolation, both input and output, by means of transformers, and shall be capable of supplying output impedances of 150 or 600 ohms, input impedances of 50, 150 and 600 ohms, balanced or unbalanced on both input and output.

The circuit board of the amplifier shall be gold-plated etched and all connections for the amplifier shall be made on a 20-pin plug on the rear of the amplifier. The amplifier shall have dimensions not exceeding 3" high by 1¾" wide and 11" long, and shall weigh no more than 3 pounds. The amplifier shall be finished in Light Gray baked enamel and shall be cadmium iridited.

The amplifier shall meet all the above conditions when receiving power from a power supply capable of delivering 24 vdc at all time by means of external sensing circuits, maintaining regulation within 0.01%, no load to full-load, and/or a line variation of 105 to 135 vac, and shall have no more than 200 microvolts rms output ripple and noise, and generate no more than a 20 millivolt transient when switching from full load to no load. The power supply shall have full-wave rectification and a power transformer with astatically balanced construction. The power supply shall utilize solid-state design and shall occupy no more than 3¼" of width, 3" of height and 11¾" of length and shall be of plug-in construction with capabilities of instant replacement in rack or turret applications. The power supply shall be capable of operating from 120 vac or 220 vac with all wiring and strapping necessary to accomplish input and output connections terminated on a connector external of the supply.

Any amplifier or power supply not conforming to the above conditions and specifications shall be deemed unacceptable under this specification.

The amplifier shall be Altec Lansing model 470A.

The power supply shall be Altec Lansing model 550A.

NOTICE
We recommend that you obtain your Altec products from factory trained authorized Altec Sound Contractors and Distributors. This will assure you of proper installation, a continuing source of knowledgeable advice, service, and quick warranty protection.

475A Amplifier

475A



Features:

DIRECT REPLACEMENT FOR
ALTEC TUBE TYPE 458A
AND 459A AMPLIFIERS

Designed to perform as:
Line, Booster, Program
or Preamplifier

Modern — All Silicon
Solid-State Design

Surpasses Specifications
of Tube Types

Frequency Response:
20-20,000 cps, ± 0.5 db!

Low Distortion

Inputs and Outputs
Completely Isolated

Astatically Balanced
Transformers

Low Heat Generation

Only 130 ma Required for
Full +27 dbm Output

Rugged—Compact—Fully
Enclosed Construction

Lightweight

Plug-in Design

SURPASSES RECORDING AND BROADCAST STANDARDS DESIGNED FOR: RECORDING, MOTION PICTURE STUDIOS — AM, FM, & TELEVISION STUDIOS — SCHOOLS — LABORATORIES — THEATERS PUBLIC ADDRESS "PROGRAM CIRCUITS" — STEREO RECORDING OF DISC, TAPE, & FILM

The Altec 475A Amplifier is a solid-state direct replacement for the tube type Altec 458A Preamplifier and the Altec 459A Program Amplifier in the Altec 250SU Control Console and will mount in the Altec 13401 mounting tray.

The Altec 475A amplifier introduces an engineering 'break-through' in solid-state professional quality amplifiers for use in recording, broadcasting and television studios. The high efficiency, extremely wide frequency response, low distortion, and virtual absence of hum and output noise enables the Altec 475A amplifier to exceed all requirements for that vital link in any first-line audio system — the preamplifier — delivering 0.5 watt, the 475A amplifier uses all silicon transistors which permit the amplifier to operate continuously at 85° C., (185° F.), without derating, and still provide operational stability not attainable with tube-type amplifiers. Transistor circuitry plus specially designed, astatically balanced transformers, enables the 475A to reach a noise figure of -127 dbm, with terminated input. The total harmonic distortion does not exceed 0.25%, 50-20,000 cps when strapped for the +18 or +27 dbm output capacity, and is less than 1.0%, 20-20,000 cps, with +27 dbm output. Overload Recovery Time is 5 microseconds for 100% overload.

The Altec 475A amplifier will produce either +18 or +27 dbm, depending on internal strapping. Utilizing transformers on both input and output with multiple impedance ranges, complete isolation is afforded for ease of matching the 475A to associated equipment. Fully enclosed construction insures that cross-talk is held to a minimum and is negligible even when adjacent amplifiers are operating with different signals and receive power from a common Altec 550A power supply.

Complex audio systems require the use of many different types of amplifiers to accomplish the mixing, level changing, impedance matching and amplification needed to produce the finest recording-broadcast quality. The Altec 475A amplifier has been designed — electrically and mechanically — to function as a preamplifier, booster amplifier or program amplifier, enabling the engineer to base his entire console design around a single amplifier type. All necessary wiring and impedance selection, via strapping, is accomplished on the 850A tray socket, allowing the 475A amplifier to be interchanged with any other 475A amplifier, regardless of its position in the circuit, without making any modifications to the amplifier or changing the channel balance or output levels. The use of Altec 475A amplifiers in this fashion makes it possible to eliminate many of the types of amplifiers needed — facilitates ease of replacement — and reduces the spare amplifiers required to one type.

The Altec 475A amplifier has been designed to meet the most rigid specifications and built under exacting standards with precision components to insure that each amplifier will not deviate in performance, but is identical in operation (within the tolerance specified) and may be used in the most critical applications where balance must be maintained between two or more amplifiers. Produced under these conditions the 475A amplifier will meet all the needs of the most sophisticated audio system, without any selection whatsoever, (as required by some manufacturers) whether used for recording, broadcasting, telecasting, specialized sound or public address systems or precision laboratory testing, and excels in performance, reliability, and trouble-free operation.



A Division of *ESPV* Ling Altec, Inc.

1515 S. Manchester Ave., Anaheim, Calif.
New York

RECORDING &

BROADCASTING

EQUIPMENT

ALTEC 475A

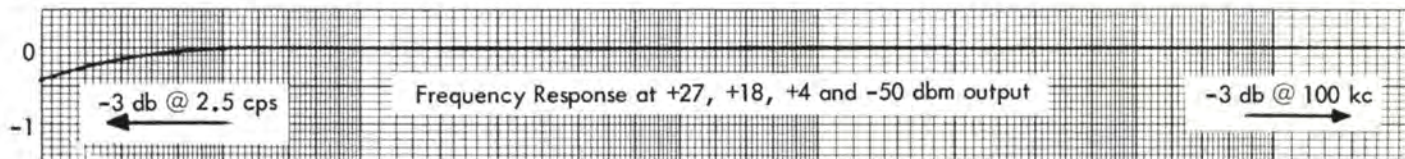

DC Input 24 vdc @ 130 ma, 3.12 watts

Noise, Unweighted
 Underterminated Input = -127 dbm
 Gain 45 db

Square Wave Rise Time = 2.5 microseconds, 20 cps slope, 25%

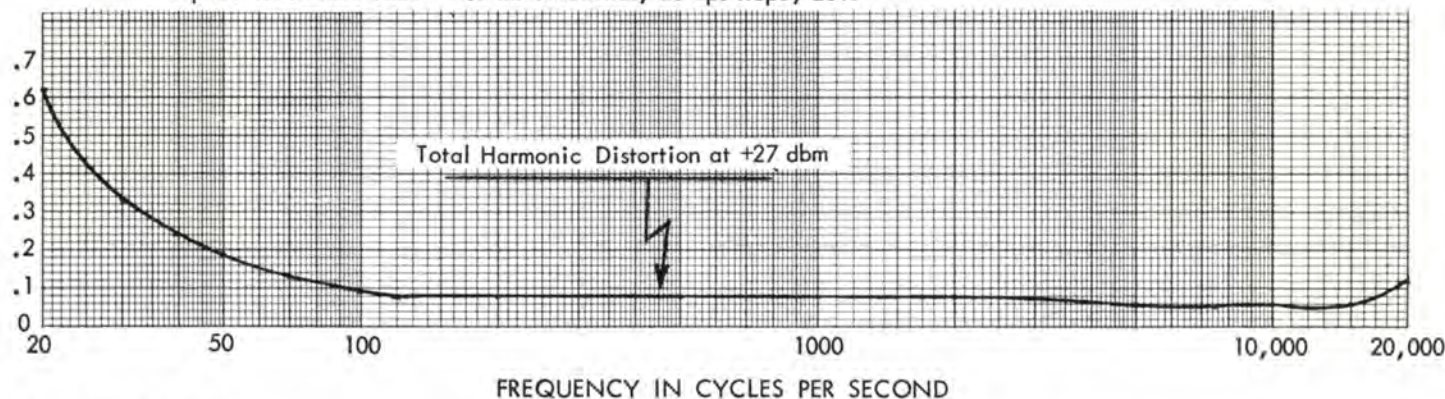

550A DESCRIPTION

The Altec 550A Power Supply, used with the Altec 475A Amplifier, is an all solid-state unit using silicon diodes in full wave bridge rectifier, and delivers 24 v dc at 2 amperes with excellent regulation provided by 5 silicon transistors and 3 zener diodes. The design of the 550A includes an external sensing circuit to insure that the output voltage will remain constant regardless of line voltage fluctuations. Output ripple and noise is only 200 microvolts under the full two ampere load.

Capable of supply power to 15 Altec 475A Amplifiers operating with full +27 dbm output, the 550A occupies only 3" of vertical rack or turret space and is only 3 1/4" wide. The 550A can operate continuously at 75 degrees C (167 degrees F) without derating any specifications including the regulation figure of 0.01%, no load to full load and/or line variation from 105 v ac to 135 v ac or 210 v ac to 270 v ac.

The output voltage of the 550A power supply is adjustable from 22 v dc to 26 v dc by means of a screwdriver adjustment on the rear of the power supply. The circuitry and components of the 550A are protected by fuses, not only in each side of the ac line, but also in the regulator

circuits, and are of the fast-acting type easily accessible at the rear of the unit.

Complete isolation between the ac input and the dc output is afforded by the use of two connectors on the rear of the 550A power supply. The 4-pin connector, used for the ac input—either 120 v ac or 220 v ac—is located directly above the 6-pin connector used for the dc output and the sensing circuits. Even with the additional isolation afforded by the use of dual connectors, the convenience of plug-in operation has been retained to facilitate ease of wiring and replacement.

When used in conjunction with the 250SU Control Console, the 550A Power Supply is not mounted within the console, but is mounted on an Altec 852A Mounting Tray adjacent or near the console as the installation requires. An accessory Connector Cover (Altec 50057) should be installed over the terminal to eliminate the shock hazard. As with all Altec products, only the highest grade components and finest workmanship are used in the 550A Power Supply, thus insuring uniform performance and trouble-free operation.

475A SPECIFICATIONS

Type:	Preamplifier, booster amplifier, or program amplifier
Gain:	45 db. (input terminated)
Frequency Response:	±0.5 db from 20 to 20,000 cps
Source Impedance:	50, 150 or 600 ohms, balanced or unbalanced (center tap on 600 ohms)
Load Impedance:	150 or 600 ohms, balanced or unbalanced (center tap on 600 ohms)
Output Impedance:	Less than 5% of nominal load
Power Output:	+27 dbm maximum from 20 to 20,000 cps
Distortion:	Less than 1% total harmonic distortion from 20 to 20,000 cps with +27 dbm output
Noise Level:	(unweighted, 10 to 25 kc band-pass) Equivalent input noise, -127 dbm (input unterminated)
Overload Recovery Time:	5 microseconds for 100% overload; continuous overload will not damage the amplifier
Controls:	None
Power Requirements:	24 v dc at 130 ma strapped for +27 dbm output
Isolation:	Transformers on input and output
Circuit:	3 stage, Class A, push-pull, direct coupled
Operating Conditions:	85° C (185° F) maximum cabinet or turret temperature for continuous duty without derating
Heat Dissipation:	3.12 watts when strapped for +27 dbm output
Dimensions:	4" H x 1 3/4" W x 9 1/2" D
Finish:	Light Gray baked enamel and cadmium iridited
Weight:	3 lbs.
Electrical Connections:	All electrical connections are made to a 15-pin plug on the rear of the 475A Amplifier
Accessories:	550A Power Supply, designed to power up to fifteen 475A amplifiers at full output 13225 Rack Mounting Assembly (accommodates 9 units) 13401 Mounting Tray Assembly

550A SPECIFICATIONS:

Type:	Solid-state power supply.
Input:	120 vac, 50/60 cycles @ .68 amp, full output, or, 220 vac, 50/60 cycles @ .40 amp., full output.
DC Output:	24 vdc @ 2 amperes, regulated.
Circuit:	Full-wave bridge rectification.
Sensing Circuit:	24 vdc to the load at all times. (May be connected to remote load.)
Output Ripple and Noise:	2 ampere load=200 microvolts rms. 1 ampere load= 75 microvolts rms.
Regulation:	0.01%, no load to full load and/or line variation of 105 to 135 vac, or line variation of 210 to 270 vac.
Output Voltage Adjustment:	Adjusted for 24 vdc when shipped. Output adjustable from 22 to 26 vdc.
Power Transformer:	Utilizes astatically balanced construction.
Fuses:	Two, 2 ampere (fast acting) in the ac line. One, 2.5 ampere (fast acting) in the regulator circuit.
Rectifier Complement:	Four 1N3569 Silicon diodes.
Regulator Complement:	One—1N706 zener diode. One—1N712 zener diode. One—1N751 zener diode. One—2N1700 silicon transistor. One—2N3055 silicon transistor. Three—2N2716 silicon transistors.
Power Consumption:	70 watts at full load.
Operating Conditions:	75° C. (167° F.) maximum cabinet or turret temperature for continuous duty, without derating.
Electrical Connections:	All connections are made to a 4 and 6 pin connector on the Altec 852A tray.
Dimensions:	3 1/4" wide, 3" high and 1 1/4" deep.
Terminals:	Plug-in.
Finish:	Light Gray baked enamel and cadmium iridited.
Weight:	6 pounds, 12 ounces.
Accessories:	Altec 852A tray. Altec 50057 Connector Cover Altec 800A mounting assembly. (Accommodates 4 Altec 550A power supplies)

The Altec 550A power supply will power up to 15 Altec 475A amplifiers at +27 dbm output.

NOTICE
 We recommend that you obtain your Altec products from factory trained authorized Altec Sound Contractors and Distributors. This will assure you of proper installation, a continuing source of knowledgeable advice, service, and quick warranty protection.

LITHO IN U.S.A.

Altec Amplifier Accessories



1551A JACK PANEL

The 1551A mounts in 1 3/4" of space in a 19-inch rack mount. Contains 12 pairs of jacks with designation strip. Jacks are 3-terminal normalled-through type, the circuit being broken when the plug is inserted (See above diagram). Finished in Altec Green.



1554A POWER DISTRIBUTION PANEL

For master power control. This panel has six outlets on the rear side controlled by the 20 ampere switch (117-120 volts). A pilot light is mounted on the face of the panel directly above the switch. Two additional outlets, not controlled by the power switch are on the front of the panel. The 1554A occupies 5 1/4" on a 19-inch rack mount. All outlets are of the 3-pin type. The 1554A is finished in Altec Green.



1552A METER PANEL

Contains a VU meter, range switch and pads and terminal strip on a 3 1/2" panel for 19-inch rack mounting. The range switch includes an "off" position and provides ranges to indicate program levels of +5, +10 and +15 VU on a 600 ohm circuit. Provisions are available for mounting an additional fixed pad for circuits of other impedance or level such as a 70 volt line. Finished in Altec Green.



1555A SWITCHING PANEL

The 1555A is a standard 3 1/2" panel for 19-inch rack mounting and contains 12 independent 2-circuit, 3-position DPDT switches and designation strips for identifying both the individual switches and the function of their different positions. Applications where the 1555A can be used include speech circuits and remote speaker selection. The panel is finished in Altec Green.

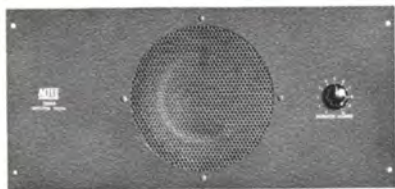

1553A MONITOR PANEL

Occupies 8 3/4" of panel space on a 19-inch rack mount and contains a 401B loudspeaker, a 15064 transformer and an adjustable "L" pad volume control. The panel is finished in Altec Green.

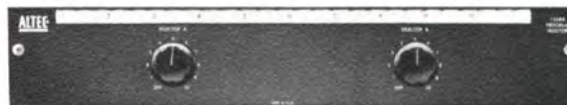

ALTEC 1558A PROGRAM SELECTOR PANEL

The Altec 1558A Program Selector Panel contains two 10-position rotary switches, each of which is individually identified as 'Selector A' and 'Selector B' and is utilized to select any of 10 program sources for its respective program channel. When used with the Altec 1556A 'Altalk,' 1557A Speaker Selector Panel, and 1559A 'All Call' Emergency Panel, the 1558A provides immediate selection of the desired program for distribution to all remote stations. The 1558A panel is supplied completely wired with a terminal board on the rear; each terminal pair is numbered and a lug is provided for terminating the shield of that pair. All terminals are of the wire-wrap and/or screw type, providing the greatest flexibility of installation in the minimum amount of time. The 1558A measures 3 1/2" by 19" for standard rack mounting and is finished in Altec Green.



A Subsidiary of Ling-Temco-Vought, Inc.

© Altec Lansing Corporation

1515 S. Manchester Ave., Anaheim, Calif.

New York



1557A SPEAKER SELECTOR PANEL

The 1557A Speaker Selector Panel is designed for use in sound distribution systems for schools, factories, offices, and all other types of installations requiring that each remote speaker station be switched to any one of four program lines from a central point. The 1557A contains a bank of twenty-five 4-position lever switches. Directly above each switch is a lucite-covered removable designation strip, on which the function of the switch may be properly written; 25 5/16" holes are drilled behind the strip so that indicator lights may be installed by the contractor, if desired. (Indicator lights and necessary hardware are not furnished). When used with the Altec 1556A 'Altalk' amplifier, 1558A Program Selector Panel, and 1559A Emergency 'All Call' Panel, the 1557A permits instantaneous selection of each of the four program sources to be distributed to each of twenty-five stations. The 1557A is completely wired internally and terminal connections (screw and/or wire-wrap) are provided for two program inputs (A & B) and 'off' (for 'all-call' or 'all-speaker'), and 'IC' (for two-way intercommunications) to all remote stations on a 'select' basis or 'all-call' for paging or emergency announcements. The 1557A measures 3 1/2" by 19" for standard rack mounting and is finished in Altec Green.



1559A "ALL CALL" EMERGENCY PANEL

The 1559A Emergency Panel is designed for school and paging systems and may be used in conjunction with the Altec 1556A 'Altalk' amplifier, 1557A Speaker Selector Panel and 1558A Program Selector Panel which are the basic components for all intercommunication systems, large or small. The 1559A provides switching facilities for both "all-call" and "all-speaker" functions. Complete flexibility for two-way intercom systems is obtainable due to the unique strapping arrangement available on the rear terminal board; all terminals are of the screw and/or wire-wrap type to provide ease of installation in minimal time. The 1559A provides many switching functions, among them the ability of switching the "all-call" or "all-speaker" bus and feeding into four speaker distribution channels (selectable: 1,2,3, and/or 4). Facilities are provided to permit the use of a separate "stand by" power amplifier or a program channel amplifier for the "all-call" facility. Also on the rear terminal board are three spare terminals for "normal through" or switching (SPDT) of control relays, lights, or other desired DC functions. The mode of operation is clearly indicated through a window located above the switch control knob; when installed, the desired function ("Normal IC-All Call" or "Normal IC-All Speakers") may be chosen by rotating the white mode identification disc. The switch is not a spring return device, hence, when the desired function is selected, it will remain in that position - eliminating the need for holding and allowing "hands free" operation. The 1559A Emergency Panel measures 3 1/2" high; the standard 19" width permits mounting in control racks. The panel is finished in Altec Green.

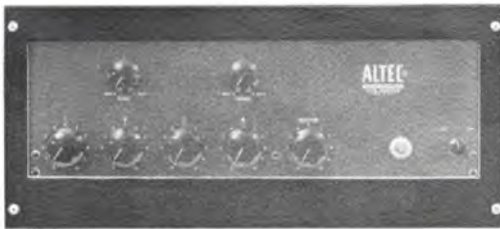

12210 ASSEMBLY

The 12210 is a rack mounting assembly that houses the ALTEC 342B amplifier and occupies only 8 3/4" of rack space in a 19-inch rack mount. The 12210 is finished in Altec Green.



4722 INPUT MATCHING TRANSFORMER

Provides low impedance microphone inputs for all Altec amplifiers requiring this plug-in microphone input transformer. Has 60 db electro-magnetic shielding; frequency response ± 1 db 30-15,000 cps; impedance 30/50, 100/200 (with C. T.), and 40,000/65,000 ohms maximum operating level: -25 dbm (above 60 cps: -19 dbm). Plug-in socket mounting. Dimensions 1 5/8" diameter x 1 13/16" high.



12156 ASSEMBLY

The 12156 is a rugged wall mounting facility that houses the ALTEC 260A amplifier and has wiring gutters for neat installations. The dimensions of the assembly are 17 3/4" h, 20" w, 12 3/8" d. The 12156 Assembly is finished in Gray Enamel.



12894 AND 12895 CABINET

Sturdy table cabinet with $8\frac{3}{4}$ " of panel space on a 19-inch rack mount. Equipment may be mounted from either side, or with shallow equipment, both sides may be used. Well ventilated with complete access to equipment from top and rear. The overall dimensions of the 12894 cabinet are 12" h, $21\frac{3}{4}$ " w, $15\frac{1}{4}$ " d. The 12895 has the same features as the 12894 cabinet except it has $17\frac{1}{2}$ " of rack space front and rear. Each of the units are finished in Altec Green.



12495 CABINET

The 12495 is a perforated metal cabinet for desk or table top use that houses the 436B and 438A ALTEC Compressor Amplifiers or any $3\frac{1}{2}$ inch panel unit. The dimensions for the 12495 cabinet are 4" h, 20" w, $7\frac{1}{2}$ " d. The cabinet is finished in Altec Green.



BLANK PANELS

Plain metal panels finished in Altec Green to provide a finished appearance to rack spaces not filled with equipment. All panels are drilled for standard rack mounting and are 19" wide.

10281 Panel — $3\frac{1}{2}$ " h.	10284 Panel — $8\frac{3}{4}$ " h.
10282 Panel — $5\frac{1}{4}$ " h.	10440 Panel — $10\frac{1}{2}$ " h.
10283 Panel — 7" h.	10441 Panel — $12\frac{1}{4}$ " h.



12864 & 13033 PHONO EQUALIZER ASSEMBLIES

The 13033 is a plug-in equalizer assembly for magnetic phono cartridge and is for use with the Altec 1561A and 1566A preamplifiers. A similar unit, Part No. 12864, is available for use with the Altec 342B amplifier and the 1567A Mixer Preamplifier. Dimensions are $1\frac{3}{16}$ " diameter x $1\frac{3}{16}$ " high.

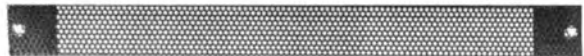

10399 PERFORATED PANEL

The 10399 is a perforated panel $1\frac{3}{4}$ " high that provides ventilation facilities from front and rear. The 10399 panel is recommended for separation between high-powered amplifiers in order to provide proper ventilation. The 10399 is drilled for 19-inch rack mounting and is finished in Altec Green.

ALTEC AMPLIFIER ACCESSORIES



13225 RACK MOUNTING ASSEMBLY

The 13225 assembly is for standard 19" rack or equipment cabinet mounting and occupies only 5¼" of panel space. The assembly has a "Snap-in" removable front cover for instantaneous access to the units for test or service. The 13225 assembly will house up to nine #13401 mounting trays (not furnished) for the 458A and 459A Altec Amplifiers or 13387 utility input devices. The finish of the front cover is Altec Green.



13800 RACK MOUNTING ASSEMBLY

The 13800 is a standard 19-inch rack mounting assembly that houses the ALTEC 356A Amplifier. The mounting assembly occupies only 5¼ inches of rack space and is finished in Altec Green.



13718 SWITCH PLATE ASSEMBLY

The ALTEC 13718 Switch Plate Assembly is an accessory recommended for use with the ALTEC 1556A ALTALK Amplifier and 1557A Speaker Selector Panel. With each 13718 Switch Plate Assembly are two semiconductor devices. When properly installed, complete privacy is assured (freedom from supervisory monitoring). This assembly is used with The Altec 15230 25-volt line transformer. The dimensions of the Switch Plate are 2¾" W x 4½" H x 2" D (including knob).



13811 RACK MOUNTING ASSEMBLY

The 13811 occupies only 7 inches of rack space and can be used for rack mounting of the following Altec components: 314 FM tuner or 360A amplifier. The assembly is finished in Altec Green.



15095 LINE TRANSFORMER

Miniature plug-in line transformer to provide balanced output for Altec amplifiers designed to accept this accessory. Has 30 db electro-magnetic shielding; ± 1 db 30-20,000 cps frequency response; 125/150, 500/600 (with C. T.), and 15,000 ohm impedances; maximum operating level of + 15 dbm above 30 cps; + 18 dbm above 40 cps. Dimensions are 1½" diameter x 1¼" high.

NOTICE
 We recommend that you obtain your Altec products from factory trained authorized Altec Sound Contractors and Distributors. This will assure you of proper installation, a continuing source of knowledgeable advice, service, and quick warranty protection.

Quick Connect Solid State Modules

SOLID
STATE
MODULES



Features:

- All Solid State
- No Interconnecting Wiring Required
- Side-by-Side Plug-in Modules
- Wide Range Frequency Response
- Extremely Low Noise Level
- High Reliability and Low Maintenance
- Economical and Versatile
- Plug-in Microphone Preamplifier, Equalizer Preamplifier (Phono), or Line Transformer
- Rugged and Compact
- Special Grounding Strap and Circuit-to-Chassis Ground Provisions
- Minimum Heat Generation
- Rack Panel Mounting
- Optional Installation Provisions for Making Tone Controls and Power Switch Inaccessible
- Meets FCC Requirements For FM Broadcast
- Small Space Requirements for Custom Control Consoles

- AUDIO AMPLIFICATION SYSTEMS • MUSIC AND PUBLIC ADDRESS SYSTEMS FOR • SCHOOLS • THEATRES • CHURCHES
- AUDITORIUMS • STADIUMS • OFFICES • CLUBS • RESTAURANTS
- SHOPPING CENTERS • MILITARY SYSTEMS

The Altec Quick Connect Solid State Modules consist of four basic units and their accessories. These components may be arranged to create versatile audio amplification systems in a variety of combinations — from the most elementary to the very complex — simply by making plug-in connections. No time-consuming wiring is required. The side-by-side plug-in design of the Quick Connect Solid State Modules — plus the convenience of the plug-in accessory preamplifiers and transformers — allows a flexibility of operation and a simplicity of installation adaptable to virtually any application, insuring a maximum of quality and flexibility for a minimum investment in money, space and labor.

The basic components of the Altec Quick Connect Solid State Modules are the 14799A Mixer Control Assembly, the 14800A Booster and Master Gain Control Assembly, the 1581A Line Amplifier and Tone Control Assembly, and the 1576A Power Supply. Accessories include the 1578A Transistor Preamplifier (for microphones), the 1579A Equalizer Transistor Preamplifier (for magnetic phono pickups), the 15095 Line Transformer, the 14953 Cables, the 14731A Dial Marker Kit, and the 1580A Mounting Assembly for Rack Mounting. All basic components (14799A, 14800A, 1581A and 1576A) are designed for single-hole panel mounting and, since they are all the same width (2½"), up to 6 may be mounted in the 1580A which is a standard 19" rack mounting assembly and occupies 5¼" of vertical space. Optional installation procedures permit the Line Amplifier and the Power Supply to be mounted at the rear of the Assembly.

The wide frequency range, low distortion and exceptionally low noise of the Quick Connect Solid State Modules permit complete design flexibility for audio systems that require custom assembly. The various units of the Quick Connect Solid State Modules may be used to complement or expand existing systems, or to form new ones. An installation may be engineered to meet the current requirements, yet allow for future expansion merely by adding equipment for new inputs and/or outputs as the need arises. The sturdy compactness and plug-in design of the Modules make them exceptionally adaptable for functional custom consoles, capable of limitless mixing inputs in multiples of ten (including one mixer which serves as a submaster) or less.

Additional monetary savings are afforded by the unique design of the Altec 1578A plug-in Transistor Preamplifier which eliminates the need for the microphone transformer usually required for use with low-impedance microphones.

Grounding straps at the rear of the mixer and the master gain control assemblies assure unit-to-unit ground integrity, and protect against extraneous noise pickup, RF pickup, and parasitic oscillations. A link on the terminals of the master gain control assembly provides a convenient means of establishing a circuit-to-chassis ground and aids in preventing possible establishment of ground loops.

The Altec Quick Connect Solid State Modules are economical — both in initial outlay and maintenance costs — and reliable; and answer the need for a truly versatile solid state audio amplification system.



A Division of *LS* Ling Altec, Inc.

1515 S. Manchester Ave., Anaheim, Calif.
New York

DESCRIPTIONS

14799A MIXER CONTROL ASSEMBLY

The 14799A mixer is a side-by-side plug-in unit containing a rotary attenuator and an isolating resistor, and with an octal socket to accommodate the plug-in accessory preamplifier or transformer. The mixer has three principal applications, dependent upon the plug-in accessory used. For low-level microphone input, an Altec 1578A preamplifier is needed. The Altec 1579A preamplifier is required for magnetic phono pickup input, and the 15095 line transformer is used for high-level balanced line-to-mixer application. In some applications one mixer may serve as a "submaster" for a group of mixers. Input to the mixer is made at screw terminals at the rear of the unit. A copper grounding strap, also at the rear, attaches to the adjoining plug-in unit. Output and power connections are made with two 3-pin connectors, a plug on one side of the mixer and a socket on the other. These connectors engage with additional mixers and/or a 14800A Booster and Master Gain Control Assembly. Like all Quick Connect Solid State Modules, the mixer is single-hole panel mounting, attaching to the mounting panel by means of the bushing on the control shaft.

14800A BOOSTER AND MASTER GAIN CONTROL ASSEMBLY

The 14800A master connects with a 1581A Line Amplifier and Tone Control Assembly by side-by-side plug-in (or 14953 cables). The master includes a plug-in 1578A preamplifier for the booster function, and will handle the output and control the overall gain from up to ten 14799A mixers. A circuit-to-chassis grounding link is provided on the terminal strip at the rear of the unit. A grounding strap attaches to the adjoining plug-in unit. Input to the master is by means of side-by-side plug-in (or cable) connections from one or more mixers.

1576A POWER SUPPLY

The 1576A power supply is a compact unit utilizing silicon rectifiers and transistors, and a zener diode. Producing 12v dc (210 ma maximum), the power supply is protected from overload by electronic current limiting and a self-resetting circuit breaker in the primary. Output connections are made with two 14953 cables (furnished with the unit). Either outlet can supply the full rated current, or it may be divided between them. Permissible load combinations for one supply are: two 1581A line amplifiers; or, one 1581A line amplifier, one 14800A master and up to ten 14799A mixers equipped with plug-in preamplifiers; or, up to sixteen mixers equipped with plug-in preamplifiers. The power supply may be either panel or shelf mounted.

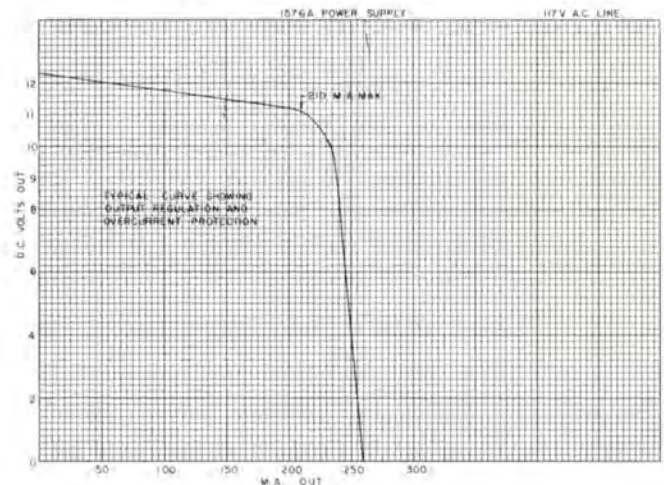

1576A Power Supply, Output Regulation and Overcurrent Protection

1581A LINE AMPLIFIER AND TONE CONTROL ASSEMBLY

The 1581A line amplifier is a compact, all-transistor unit designed to equalize the signal from the master. Dual concentric knobs on the front provide for bass and treble control. Input connections are made with side-by-side plug-in

(or cable) connections. Power connections are made through two 3-pin plugs and two cables from the power supply. Output connections are made from a four-post terminal strip which may be strapped for either 150 or 600 ohms output. The 1581A may be either panel or shelf mounted.

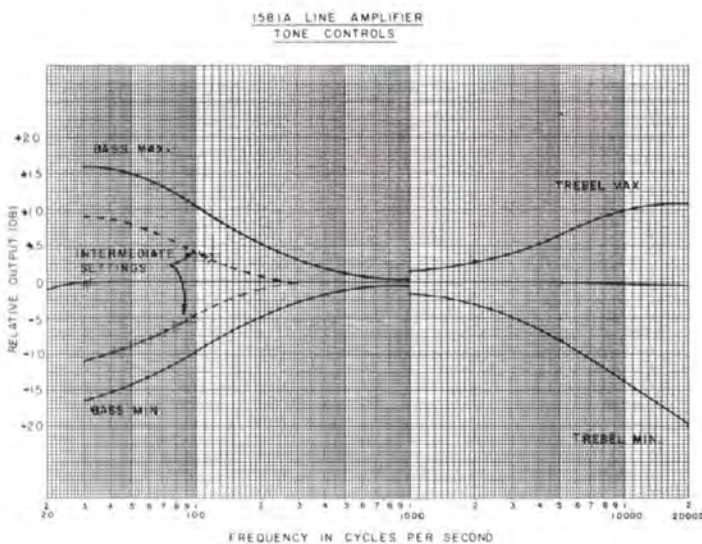

1581A Amplifier, Tone Controls

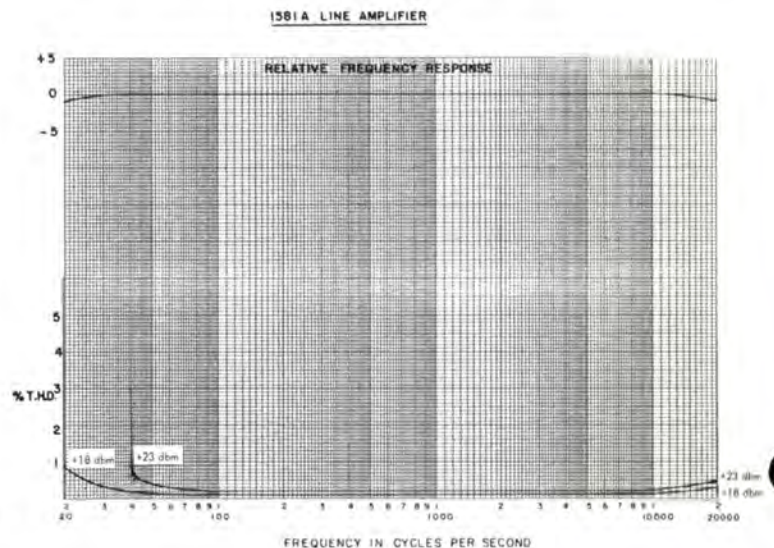

1581A Amplifier, Frequency Response

ACCESSORIES

1578A TRANSISTOR PREAMPLIFIER

The 1578A is a plug-in preamplifier used for low-level microphone input with the mixers, and as the booster in the 14800A master. The preamplifier has a gain of 33.5 db and sensitivity is 43 millivolts rms for an output of +8 dbm. Frequency response is ± 0.5 db from 20 to 20,000 cps; or ± 1.5 db from 15 to 50,000 cps. Source impedance is 150 ohms nominal, usable from 30 to 20,000 ohms. Equivalent input noise is -122 dbm. The 1578A requires 12 v dc at 13 ma.

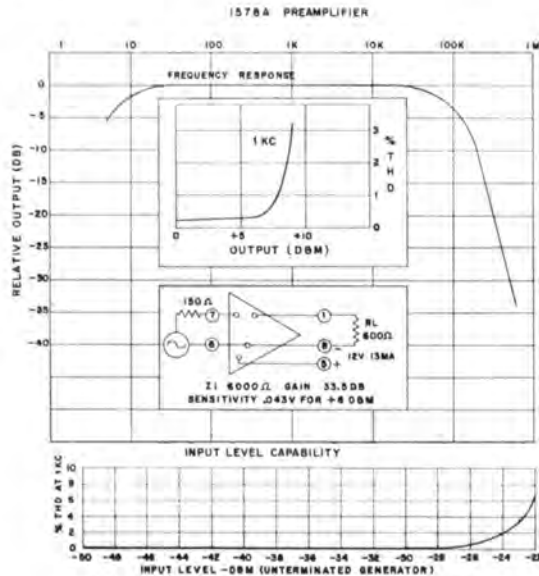

1579A EQUALIZED TRANSISTOR PREAMPLIFIER

The 1579A preamplifier is designed for use with magnetic phono pickups and will equalize them to meet the RIAA standard. Sensitivity is 5 millivolts for 70 millivolt output at 1 kc. Output is +8 dbm at less than 0.5% thd. Input impedance is 47,000 ohms and the power required is 12 v dc at 11 ma.

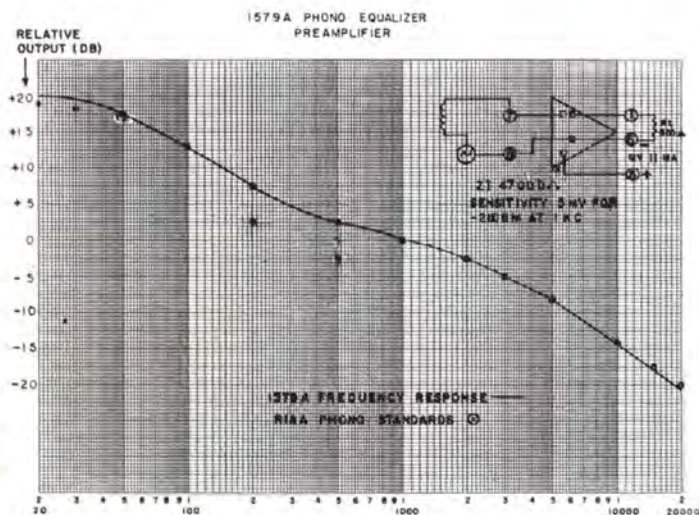

1579A Preamplifier, Frequency Response

15095 LINE TRANSFORMER

The 15095 is a 15,000 to 600 ohm line transformer and may be used in a mixer for bridging a balanced 600-ohm line. The 600-ohm winding feeds the mixer bus and the 15,000-ohm winding bridges the source. With the connection of a 680-ohm resistor across the mixer input terminals, the transformer may be used for terminating purposes. It has 30 db of electro-magnetic shielding and a frequency response of ± 1 db from 30 to 20,000 cps.

1580A MOUNTING ASSEMBLY FOR RACK MOUNTING

The 1580A assembly will accommodate up to six units of the Quick Connect Solid State Modules by means of single-hole panel mounting. Screw holes in the bottom of the line amplifier and the power supply will line up with holes in the tray, permitting these two units to be attached with screws in addition to the panel mounting, if desired. An optional arrangement permits the power supply and the line amplifier to be mounted at the rear of the tray where the tone controls and the switch on the power supply may be made inaccessible. The 1580A assembly occupies 5 1/4" of rack space and weighs 4 1/2 pounds.

14953 CABLES

Two 14953 Cables are furnished with each 1576A power supply and are used to make connections between the power supply and other units, or to make short interconnections between various units, as the installation requires. Each 3-wire cable is 12 inches in length, and terminated with a 3-pin plug at one end and a 3-pin socket at the other.

14731A DIAL MARKER KIT

The Dial Marker Kit provides an adjustable reference for setting the controls on the various Quick Connect Solid State Modules. Each kit consists of five clear plastic discs which mount against the panel under the control knob. Although they may be rotated to change the position of the indicator line on the disc, they are spring-loaded to prevent any inadvertent alteration in the setting.

SPECIFICATIONS

14799A MIXER CONTROL ASSEMBLY

Controls:	Mixer control
Connections:	(Input) 3 screw terminals (Output and Power) 3-pin plug and 3-pin socket
Accessory Connection:	Octal socket for plug-in option
Escutcheon Plate:	Dial plate furnished
Mounting:	Single-hole panel mounting
Dimensions:	3 $\frac{3}{4}$ " H x 2 $\frac{1}{2}$ " W x 2 $\frac{1}{4}$ " D (including plug-in option, but excluding knob and connectors)
Color:	Green
Weight:	7 oz. (excluding plug-in option)

14800A BOOSTER AND MASTER GAIN CONTROL ASSEMBLY

Gain:	+27 db voltage gain with 1000 Ω termination
Power Requirements:	12 v dc at 13 ma
Controls:	Master gain control
Connections:	(Input) 3-pin socket (Output and Power) 3-pin plug
Mounting:	Single-hole panel mounting
Escutcheon Plate:	Dial plate furnished
Dimensions:	3 $\frac{3}{4}$ " H x 2 $\frac{1}{2}$ " W x 2 $\frac{1}{4}$ " D (including booster amplifier, but excluding knob and connectors)
Color:	Green
Weight:	8 $\frac{1}{2}$ oz. (including booster amplifier)
Equipment Furnished:	1578A Transistor Preamplifier (plug-in) furnished as booster amplifier
Features:	Link on terminals at rear of unit permits establishment of circuit-to-chassis ground.

1581A LINE AMPLIFIER AND TONE CONTROL ASSEMBLY

Gain:	47.5 db from 600 Ω generator
Input Sensitivity:	0.098 v for +23 dbm output
Power Output:	+23 dbm at less than 1% thd, 45-20,000 cps +18 dbm at less than 0.5% thd, 25-20,000 cps
Frequency Response:	± 1 db from 20 to 20,000 cps
Source Impedance:	Up to 1000 Ω
Load Impedance:	150 or 600 Ω , ungrounded (center tap available in 600 Ω connection)
Noise Level:	-61 dbm with 1000 Ω input termination
Controls:	Concentric bass and treble controls
Power Requirements:	12 v dc at 70 ma
Connections:	(Input) 3-pin socket (Output) 4 screw terminals (Power) 2 3-pin plugs
Test Facilities:	2 meter test jacks on connector side of unit
Mounting:	Single-hole panel mounting, or shelf mounting
Escutcheon Plate:	Dial plate furnished

Dimensions:	4 $\frac{1}{2}$ " H x 2 $\frac{1}{2}$ " W x 5 $\frac{1}{2}$ " D (excluding knob and connectors)
Color:	Green
Weight:	1 $\frac{1}{2}$ lbs.

1576A POWER SUPPLY

Power Output:	12 v dc, 210 ma maximum
Regulation:	(Line) 10%, 110 to 135 v ac, 210 ma load (Load) 10%, no load to full load
Controls:	Rotary ON-OFF switch on front panel
Ripple:	0.3 mv peak to peak
Power Input:	117 v ac, 50 to 60 cps. 8 watts at full load
Load Connections:	2 3-pin sockets (210 ma load current available from outputs in any combination)
Protection:	(Line) Self resetting circuit breaker in primary (Load) Electronic current limiting protects regulator against overcurrent
Mounting:	Single-hole panel mounting, or shelf mounting
Escutcheon Plate:	Dial plate furnished
Dimensions:	4 $\frac{1}{2}$ " H x 2 $\frac{3}{16}$ " W x 5 $\frac{1}{2}$ " D (excluding knobs and connectors)
Color:	Green
Weight:	2 $\frac{1}{2}$ lbs.

1578A TRANSISTOR PREAMPLIFIER (PLUG-IN ACCESSORY)

Gain:	33.5 db
Sensitivity:	43 millivolts rms for +8 dbm output
Frequency Response:	± 0.5 db from 20 to 20,000 cps, or ± 1.5 db from 15 to 50,000 cps
Source Impedance:	150 Ω , nominal, usable 30 to 20,000 Ω
Load Impedance:	600 Ω
Noise Level:	-122 dbm equivalent input noise
Power Requirements:	12 v dc at 13 ma
Mounting:	Standard octal socket
Dimensions:	1 $\frac{3}{8}$ " diameter x 1 $\frac{1}{8}$ " seated height
Weight:	1 oz.

1579A EQUALIZER TRANSISTOR PREAMPLIFIER (PLUG-IN ACCESSORY)

Sensitivity:	5 millivolts for 70 millivolt output at 1 kc
Power Output:	+8 dbm at less than 0.5% thd
Frequency Response:	Equalized to meet RIAA standard for magnetic phono pickup (see curve)
Source Impedance:	47,000 Ω
Load Impedance:	600 Ω
Power Requirements:	12 v dc at 11 ma
Mounting:	Standard octal socket
Dimensions:	1 $\frac{3}{8}$ " diameter x 1 $\frac{1}{8}$ " seated height
Weight:	1 oz.

TYPICAL APPLICATIONS

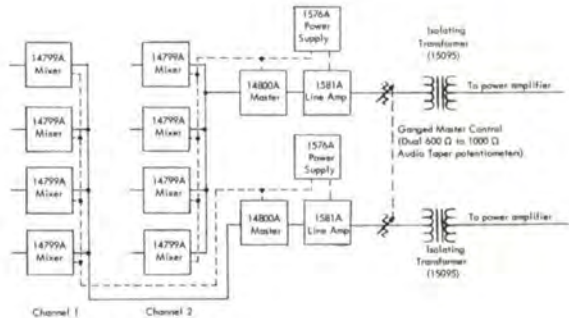
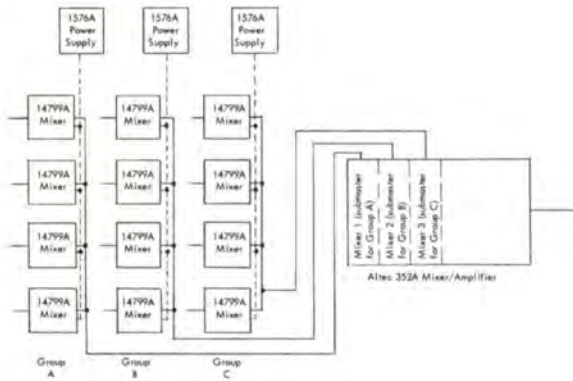
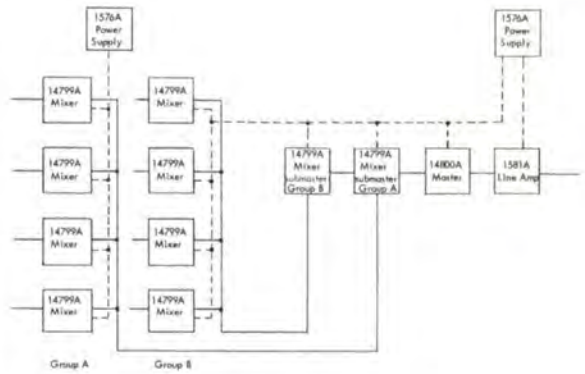
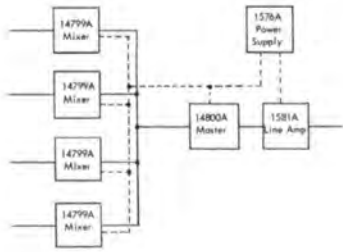

Altec Quick Connect Solid State Modules

ORDERING INFORMATION

Although the requirements of each individual installation will vary, the following information will serve as a guide to the purchaser in ordering Altec Quick Connect Solid State Modules.

For each microphone input:	Order 1 - 14799A Mixer Control Assembly 1 - 1578A Transistor Preamplifier
For each magnetic phono pickup input:	Order 1 - 14799A Mixer Control Assembly 1 - 1579A Equalizer Transistor Preamplifier
For each line input:	Order 1 - 14799A Mixer Control Assembly 1 - 15095 Line Transformer
For a system of up to 10 inputs and line level outputs:	In addition to input requirements stated above — Order 1 - 14800A Booster and Master Gain Control Assembly 1 - 1581A Line Amplifier and Tone Control Assembly 1 - 1576 Power Supply
For each addition mixer group: (Maximum - 9 inputs)	Order 1 - 14799A Mixer Control Assembly (to serve as 'Submaster') 1 - 1576A Power Supply
*For each additional channel:	Order 1 - 14800A Booster and Master Gain Control Assembly 1 - 1581A Line Amplifier and Tone Control Assembly 1 - 1576A Power Supply
For each 6 Modules (or less) intended for 19-inch rack panel mounting:	Order 1 - 1580A Mounting Assembly for Panel Mounting
For each group of 5 mixers and/or masters:	Order 1 - 14731A Dial Marker Kit

* For stereo systems, the addition of a dual 600 Ω to 1000 Ω audio taper potentiometer is required.

A custom (mixer) (console) (select one) shall be assembled in a workmanlike manner, and shall be composed of side-by-side plug-in modules, with provisions for plug-in preamplifiers, booster and line amplifiers, and transformers. All units shall employ solid-state devices only. Units requiring interconnecting wiring for power, signal input and/or output, or utilizing vacuum tubes, shall not be acceptable. The system shall consist of — mixer assemblies which shall be capable of mixing the input signals originating from — microphone(s), — phono pickup(s), — radio tuner(s), — tape machine(s), or equivalents. All input wiring shall terminate at screw-type terminal strips provided for each separate input. There shall be a 750 Ω potentiometer with audio taper and proper build-out resistor for each input and a socket provided for various types of plug-in accessories which shall provide proper termination of input lines to each mixer module and which shall be capable of accepting signals from low level, low-impedance sources, magnetic phono pickups, and bridged low-impedance lines. A booster amplifier and master gain control assembly shall amplify and control the gain of the combined signals from the mixers. The booster function shall be provided by a plug-in transistor preamplifier. A separate line amplifier shall have concentric tone controls for the bass and treble tones.

— separate power supply (ies), operating from 120 v ac, shall be capable of powering the installation and (each) shall provide a total output of 12 v dc at no less than 210 ma. Unit-to-unit ground integrity between mixer and master assemblies shall be by the use of a copper grounding strap of not less than $\frac{5}{16}$ of an inch wide. Circuit-to-chassis ground shall be made on the booster and master gain control module.

14799A MIXER CONTROL ASSEMBLY

The mixer control assembly shall be of the side-by-side plug-in type utilizing 3-pin plugs and sockets to accomplish all power and output functions, and to minimize the physical separation of assemblies to not more than $\frac{1}{4}$ inches. The module shall provide an octal socket for accommodation of selected preamplifier and/or transformers of the plug-in variety, specified elsewhere. The circuitry shall include a 750 Ω potentiometer and a 820 Ω isolating resistor for mixing purposes. Input wiring shall terminate at a three-post terminal strip, one terminal of which shall be attached to copper grounding strap of not less than $\frac{5}{16}$ inches in width to insure unit-to-unit ground integrity. The mixer module shall be of the single-hole panel mounting type and shall use the bushing of the control shaft to secure it in position on the panel. The module shall not occupy more than $3\frac{3}{4}$ " in height, $2\frac{1}{2}$ " in width, and $2\frac{1}{4}$ " in depth, including the optional plug-in accessory, but excluding the knob and connectors; and shall not weigh more than 7 ounces, excluding the plug-in accessory.

Any mixer control assembly not meeting all these requirements shall be deemed unacceptable under these specifications. The mixer shall be Altec Lansing Model 14799A.

14800A BOOSTER AND MASTER GAIN CONTROL ASSEMBLY

The booster and master gain control assembly shall be of the side-by-side plug-in type utilizing 3-pin plugs and sockets to accomplish all power, input and output functions, and to minimize the physical separation of units to no more than $\frac{1}{4}$ inch; and shall provide an octal socket to accommodate a transistor preamplifier of the plug-in variety, specified elsewhere, to serve the booster function. The circuitry shall include a 750 Ω potentiometer and a 1000 Ω resistor for gain control purposes. A copper grounding strap of not less than $\frac{5}{16}$ inch in width shall insure unit-to-unit ground integrity, and the circuit-to-chassis ground shall be established by means of a terminal link at the rear of the module. Common chassis ground or ground wire will not be acceptable under these specifications. The assembly shall have a voltage gain of +25 db with a 1000 Ω termination, and shall have a power requirement of 12 v dc at not more than 13 ma. The master module shall be of the single-hole panel mounting type and shall use the bushing of the control shaft to secure it in place on the panel. It shall not occupy more than $3\frac{3}{4}$ " in height, $2\frac{1}{2}$ " in width, and $2\frac{1}{4}$ " in depth including the plug-in preamplifier but excluding knobs and connectors, and shall not weigh more than $8\frac{1}{2}$ ounces, including the plug-in preamplifier.

Any booster and master gain control assembly not meeting all these requirements shall be deemed unacceptable under these specifications. The master assembly shall be Altec Lansing Model 14800A.

1581A LINE AMPLIFIER AND TONE CONTROL ASSEMBLY

The line amplifier and tone control assembly shall be of the side-by-side plug-in type utilizing 3-pin plugs and sockets, or optional 3-wire cable connections, to accomplish all power and input functions; and shall employ only solid-state devices. Output shall be from a 4-post terminal board which shall have provisions for optional 150 Ω or 600 Ω output with a center tap available on the 600 Ω connection. The unit shall have a gain of

not less than 47.5 db from a 600 Ω generator, a power output of not less than +23 dbm at not more than 1% thd from 45 to 20,000 cps; or +18 dbm at not more than 0.5% thd from 25 to 20,000 cps; and input sensitivity of 0.098 v for a +23 dbm output. The module shall have a frequency response of ± 1 db from 20 to 20,000 cps, and a source of impedance of up to 1000 Ω . Noise level shall be no more than -61 dbm with a 1000 Ω termination, and the module shall have a power requirement of 12 v dc at not more than 70 ma. The unit shall have dual concentric knobs with the larger, outer knob for bass control and a smaller, inner knob for treble control, and two meter test jacks shall be provided for test facilities. The module shall be not more than $4\frac{1}{2}$ " in height, $2\frac{1}{2}$ " in width and $5\frac{1}{2}$ " in depth, excluding knob and connectors, and shall weigh not more than $1\frac{1}{2}$ pounds. The unit shall be of the single-hole panel mounting type and shall use the bushing of the control shaft to secure it in place on the panel, and it shall have provisions for optional shelf mounting.

Any line amplifier and tone control assembly not meeting all these requirements shall be deemed unacceptable under these specifications.

The line amplifier and tone control assembly shall be Altec Lansing Model 1581A.

1576A POWER SUPPLY

The power supply shall deliver 12 v dc and shall employ only solid-state devices. Protection against overcurrent shall be provided by electronic current limiting and by a self resetting circuit breaker in the primary. The unit shall maintain regulation within 10% no load to full load and/or 110 to 135 v ac, and with not more than 0.3 mv peak-to-peak ripple. Output shall be from two 3-pin sockets which shall provide a load current of not less than 210 ma in any combination. A rotary ON-OFF switch and a 'switch-on' indicator light shall be provided on the front of the module. The power supply shall not occupy more than $4\frac{1}{2}$ " in height, $2\frac{3}{8}$ " in width, and $5\frac{1}{2}$ " in depth, excluding knobs and connectors, and shall not weigh more than $2\frac{1}{2}$ pounds. The module shall be single-hole panel mounting, and shall have provisions for optional shelf mounting.

Any power supply not meeting these requirements shall be deemed unacceptable under these specifications.

The power supply shall be Altec Lansing Model 1576A.

1578A TRANSISTOR PREAMPLIFIER

The microphone preamplifier shall be a solid-state, plug-in unit encased in a mu-metal shield and requiring 12 v dc at 13 ma. The preamplifier shall have a gain of 33.5 db and a sensitivity of 43 millivolts rms for a +8 dbm output. It shall be capable of reproducing a frequency range of 20 to 20,000 cps within ± 0.5 db, and maintain a noise level of -122 dbm (equivalent input noise). Source impedance shall be 150 Ω , nominal, usable from 30 to 20,000 Ω ; and load impedance shall be 600 Ω . The unit shall mount in a standard eight-pin octal socket, and shall not measure more than $1\frac{3}{8}$ " in diameter and $1\frac{1}{8}$ " in seated height; and shall not weigh more than 1 ounce.

Any microphone preamplifier not meeting all these requirements shall be deemed unacceptable under these specifications.

The preamplifier shall be Altec Lansing Model 1578A.

1579A EQUALIZER TRANSISTOR PREAMPLIFIER

The equalizer preamplifier for magnetic phono pickups shall be a solid-state, plug-in unit encased in a mu-metal shield and requiring 12 v dc at 11 ma. Distortion of the equalizer preamplifier shall not exceed 0.5% thd at +8 dbm output power, and shall have a sensitivity of 5 millivolts for a 70 millivolt output at 1 kc. The frequency response shall be equalized to meet RIAA standards for a magnetic phono pickup. Source impedance shall be 47,000 Ω , and load impedance shall be 600 Ω . The unit shall mount in a standard eight-pin octal socket, and shall not measure more than $1\frac{3}{8}$ " in diameter and $1\frac{1}{8}$ " in seated height; and shall not weigh more than 1 ounce.

Any preamplifier not meeting all these requirements shall be deemed unacceptable under these specifications.

The equalizer preamplifier shall be Altec Lansing Model 1579A.

15095 LINE TRANSFORMER

The line transformer shall be a 15,000 to 600 Ω line transformer with a source impedance of 15,000 Ω and a load impedance of 600 Ω . It shall have a frequency response of ± 1 db from 30 to 20,000 cps. It shall be equipped with 30 db of electro-magnetic shielding. The transformer shall not measure more than $1\frac{3}{8}$ " in diameter and $1\frac{1}{8}$ " in seated height, and shall not weigh more than 1 ounce.

Any line transformer not meeting these requirements shall be deemed unacceptable under these specifications.

The line transformer shall be Altec Lansing Model 15095.

NOTICE
We recommend that you obtain your Altec products from factory trained authorized Altec Sound Contractors and Distributors. This will assure you of proper installation, a continuing source of knowledgeable advice, service, and quick warranty protection.

LOUDSPEAKERS

PLAYBACK *and speech-input* equipment for recording and broadcast studios

ALTEC

FULL-RANGE SPEAKERS

FULL RANGE SINGLE VOICE COIL SPEAKERS

There are many applications in the recording and broadcast plant where loudspeakers of lesser power and frequency range than that required for top echelon **PLAYBACK** are needed, and where size, limited space and economy are

415C AND 412C BIFLEX LOUDSPEAKERS. The patented multiple compliance of the Biflex principle achieves unusually wide frequency range though allowing the smaller center cone area to operate independently for more efficient reproduction of the treble, whereas the entire cone area is called into play for the lower frequencies. The crossover is effected mechanically at 1000 cycles.

755C LOUDSPEAKER. Originally designed by the Bell Laboratories, this small 8 inch speaker has been a standard of quality in the broadcast and recording field for many years because of its wide, smooth response and the broad angle of distribution provided by its shallow cone design. Use of a ceramic magnet achieves extremely slim profile for mounting in shallow enclosures.

considerations. Examples are music distribution, paging, the very small control room, mastering rooms, for cuing, auditioning, etc. The following speakers are suggested for these purposes.



ENGINEERING SPECIFICATIONS

	415C	412C	755C
POWER:	25 watts	20 watts	15 watts
FREQUENCY RESPONSE:	25-14,000 cps	30-15,000 cps	40-15,000 cps
SENSITIVITY:	101 db (Sound Pressure Level at 4 ft. from 1 watt ^{**})	100 db (Sound Pressure Level at 4 ft. from 1 watt ^{**})	95.5 db (Sound Pressure Level at 4 ft. from 1 watt ^{***})
IMPEDANCE:	8 ohms	8 ohms	8 ohms (2" voice coil)
VOICE COIL DIAMETER:	3"	3"	2"
CONE RESONANCE:	27 C.P.S.	36 C.P.S.	52 C.P.S.
DIAMETER:	15 3/8"	12 1/8"	8 3/8"
MAGNET WEIGHT:	2.4 lbs.	1.8 lbs.	Special high flux indox V
MOUNTING HOLE DIAMETER:	13 1/4"	10 1/4"	4 equally spaced at 7 3/8"
DEPTH:	7"	5 5/8"	2 1/4"
WEIGHT:	17 1/2 lbs.	15 lbs.	3.75 lbs.

^{**}Equivalent to EIA rating of 54 db at 30 feet from 1 milliwatt. ^{**}Equivalent to EIA rating of 53 db at 30 feet from 1 milliwatt.

^{***}Equivalent to EIA rating of 48.5 db at 30 feet from 1 milliwatt.

TWO WAY SPEAKER COMPONENTS FOR SMALL **PLAYBACK** SYSTEMS

Two combinations of components are offered below to provide the advantages of two way speaker systems economically priced which can readily be built into custom cabinets for a variety of applications where good quality of **PLAYBACK** is required at economical prices.

ENGINEERING SPECIFICATIONS

	Combination #1* 3000B High Frequency Speaker	Combination #2** 2000B High Frequency Speaker
POWER RATING:	20 watts	14 watts
IMPEDANCE:	8 ohms	8 ohms
FREQUENCY RESPONSE:	3000-22,000 cycles	1500-18,000 cycles
SOUND DISTORTION:	90° x 40°	60°
VOICE COIL DIAMETER:	3/4"	1"
DIMENSIONS:	3 3/4" H x 4 7/8" W	5" diameter, 3 3/8" deep
WEIGHT:	1 lb.	1.14 lbs.

	414A Bass Speaker	402B Bass Speaker
POWER RATING:	25 watts	14 watts
IMPEDANCE:	16 ohms	16 ohms
FREQUENCY RESPONSE:	30-4000 cycles	40-10,000 cycles
CONE:	Molded fibre high compliance cloth surround covered with mechanical resistance.	Molded fibre high compliance cloth surround covered with mechanical resistance.
VOICE COIL:	Edge-wound copper ribbon, 3" in diameter.	1" diameter
MAGNET WEIGHT:	1.8 lbs., Alnico V.	45 lbs., Alnico V.
GAP FLUX:	10,000 gauss	
CONE RESONANCE:	30 cycles	55 cycles
DIMENSIONS:	12 1/4" diameter, 5 5/8" deep	8" diameter, 3 3/8" deep
WEIGHT:	15 lbs.	2.13 lbs.



*N-3000E Network (order extra); is required with combination #1.

IMPEDANCE: 8 ohms; CROSSOVER: 3,000 cycles; HF SHELVEING: 10 db, constantly variable; DIMENSIONS: 2 3/4" H x 4 7/8" W x 2 3/8" D; WEIGHT: 1 lb.

**Dividing Network: Combination #2 has 2,000 cycle network built into 2000B.

FURNITURE FINISHED SPEAKER SYSTEMS

Although not the general requirement, there are special management considerations in the broadcasting and recording industry for fine furniture-finished speaker systems of the very best quality for top echelon **PLAYBACK** use in executive offices, lobby, boardrooms, or even in some beautifully furnished studios. The following two-way speaker systems in tastefully designed cabinets of several furniture finishes are offered for these special considerations. The two compact units, the 835B and 836A, also have their uses as ready-assembled two-way systems for stereo and multiple channel **PLAYBACK** monitoring in small control rooms, client's rooms, and other requirements throughout the studio where space is limited and the areas are relatively small.

ALTEC 838A "CARMEL" TWO-WAY SPEAKER SYSTEM



The Altec 838A "Carmel" embodies the perfect balance of size, appearance, and audio quality to please the most discriminating professional user both visually and acoustically. The mid-range or presence region of the Carmel system is particularly fine—the over-all effect is of extreme naturalness . . . a very distinct "feeling" of the actual performance as it is being monitored through the engineer's control room or **PLAYBACK** in the studio.

The "Carmel" is a professional-type two-way, bass reflex system with a guaranteed frequency range from 30-22,000 cycles. Power rating: 30 watts. Two new high compliance 414A Bass Speakers provide clean, distortion-free low frequency reproduction. An Altec 804A driver mounted on an 811B Horn covers the highs to 22,000 cycles — well beyond the range of human hearing. An -800 cycle Altec network provides the necessary crossover.

Dimensions: 29 $\frac{3}{4}$ " H x 35" L x 17 $\frac{3}{4}$ " D.

CUSTOM DECORATOR BASE
 #30536 MAY BE ORDERED
 AS AN EXTRA ACCESSORY
 FOR "CARMEL" OR "AVALON."



Altec 838A Carmel **PLAYBACK** Speaker System will be exhibited at the 1964-65 New York World's Fair. As a complete stereo ensemble, it will be featured in the Coble Contemporary Home at the HOUSE OF GOOD TASTE exhibit.

ALTEC 837A "AVALON" SPEAKER SYSTEM

A similar system — the Altec 837A "Avalon" — is available in an identical cabinet. For greater economy, the 837A incorporates a single 414A Speaker. The high frequency section is the same as in the 838A. Dimensions: 29 $\frac{3}{4}$ " H x 35" L x 17 $\frac{3}{4}$ " D.

ALTEC ENCLOSURE MODEL 854A/B

The same cabinet used in the 837A and 838A systems may be ordered without sound components as model 854A/B which is of the infinite baffle type. This model is constructed to house any Altec Biflex and Duplex 12" or 15" speaker. For an example — you may decide to choose an Altec 605A Duplex.

Models 837A, 838A and 854A/B are available in either walnut or mahogany finish.

831A CAPISTRANO

The elegant simplicity of the Capistrano, selected for its excellence of design in the California Design Exhibit, is the perfect complement to the precision-engineered sound components it encloses; one 15" 803B controlled linear excursion bass speaker, an 804A high frequency driver mounted on an 811B Sectoral Horn producing a frequency response of 35-22,000 cps. The graceful styling of the 831A enclosure is as outstanding visually as the performance is outstanding audibly and offers a more appealing decor in the visitor's lobby or hospitality room in recording and broadcast studios. Specifications: Frequency Range: 35 to 22,000 cps, Power rating: 30 watts, Impedance: 16 ohms, Finish: Walnut, Mahogany, Dimensions: 30" Height, 47" Width, 23 $\frac{1}{2}$ " Depth, Approximate weight: 120 lbs.



841A "CORONADO"

Altec's "Coronado" brings a really new dimension for studio **PLAYBACK** applications. It is styled to match a pair of "Carmels" or "Avalons," bearing same height dimensions when used as the center speaker in a three-channel stereo system, or can be used in pairs, or monophonically. It can be ideally situated in recording executive's listening room, visitors lobby, and hospitality rooms . . . without legs it can be applied to the engineer's control room and utilized as a monitoring speaker system.



Housing an Altec 414 12" woofer and an Altec 3000 sectoral horn and driver with the new Altec Mylar diaphragm, the "Coronado" provides a full 40-22,000 cps frequency response with 20 watts input power. A full two-section Altec -3000 cycle network divider permits each speaker to handle only those frequencies for which it was engineered. The 841A cabinet is furnished in either walnut or mahogany and measures 29 $\frac{3}{4}$ " H x 19"W x 14"D and is lined with fiberglass for maximum clarity without resonances or reflections.

836A "LIDO"

For the smaller broadcast station or recording studio, the Altec "Lido" system provides excellent audio reproduction for monitoring where space is at a premium in the engineer's control room. The 836A "Lido" incorporates two 8" speakers in a laboratory-designed enclosure; at lower frequencies, both units work in phase furnishing the audio engineer with a cone area in excess of the majority of low-frequency transducers requiring far larger cabinets. In the higher frequencies, a specially-designed dividing network makes use of the famous Altec 755C reproducer for maximum response and distribution characteristics.



Frequency range: 40-15,000 cps. Impedance: 8 ohms. Power rating: 15 watts. Dimensions: 12 $\frac{3}{8}$ " H x 26"W x 12 $\frac{3}{8}$ " D. Walnut or mahogany finish.

835B "MONTEREY, JR."

For applications requiring a smaller, easily portable, wide range loudspeaker system, the Altec "Monterey, Jr." satisfies the critical engineer while meeting the majority of professional specifications. The Altec 2000B high-frequency transducer, with its specially designed aluminum diaphragm and rimless cone suspension, reproduces every frequency up to and above 18,000 cycles: the high compliance 402B low-frequency speaker, correctly baffled in the bass-reflex enclosure, faithfully transmits all frequencies down to 45 cycles with maximum efficiency.



Frequency range: 45-18,000 cps. Impedance: 16 ohms. Power rating: 15 watts. Dimensions: 11 $\frac{1}{4}$ " H, 23" W, 11 $\frac{1}{4}$ " D. Walnut, blonde, or unfinished.



Monitor / Playback Speaker System

844A SPEAKER SYSTEM

844A



844A Monitor Speaker System

Features: 844A

- Complete Two-way Monitor Speaker System
- Recording and Broadcast PLAYBACK Quality
- From 30 to 22,000 cycle range
- Wide Angle 40° x 90° Distribution
- Wall or Ceiling Mounting
- Compact
- Acoustically Engineered
- Two LF Speakers
- Heavy Cast Aluminum Sectoral HF Horn
- Compression HF Driver
- High Efficiency
- Field Replaceable HF Diaphragm and Voice Coil
- Distortion Free Reproduction
- Low 800 Cycle Crossover Frequency
- Dual Full-Section Crossover Network
- Adjustable HF Shelving Control

MONITORING SPEAKER SYSTEMS FOR: RECORDING STUDIOS BROADCASTING TELECASTING STATIONS MOTION PICTURE AND AUDIO VISUAL STUDIOS

The unusual new 844A Monitor/Playback speaker system has been created to fulfill requests from the audio industry for a compact wall-type monitor comparable with the famous Altec 'Voice of the Theatre' series that can be easily mounted above control room observation windows and requires no special tilting or 'aiming' of the enclosure. Engineered to conform to rigid laboratory specifications, the 844A meets the 'no compromise' requirements of the professional sound engineer and, utilizing Altec's years of experience in sound reproduction backed with proficient production principles, the 844A is priced within the financial ability of the modestly budgeted studio or broadcasting station.

The professional Playback quality of the Altec 844A Monitor Speaker System makes it equally suitable for nightclubs, discotheques, small auditoriums, restaurants, or similar establishments employing public address or sound reinforcement systems that require the highest quality of sound reproduction. An unusual advantage lies in the design of the enclosure which permits the 844A to be mounted flush to the wall — without distorting or creating phase problems — an advantage which allows fast, simple installations and enhances the appearance of the sound reinforcement system.

The 844A includes two special Altec 414-type, low frequency speakers which produce a uniform response from 30 cycles to the crossover frequency of 800 cycles. Utilizing heavy Alnico V permanent magnets, these outstanding 12-inch transducers contain edge-wound copper ribbon voice coils of the largest practical diameter and exceptionally compliant cone suspension; features which combine the advantages of long-term operation with unparalleled response throughout the entire bass frequency range. Rear-loading for these low frequency speakers is provided by the exacting bass-reflex enclosure.

An Altec 804A high frequency compression driver coupled to a cast aluminum sectoral horn reproduces from the crossover frequency of 800 cycles up to 22,000 cycles, furnishing the distortion free mid- and high-frequency reproduction that is required by all major recording and broadcasting studios. The driver has a voice coil of notably large diameter (1 3/4") edge-wound with aluminum ribbon and coupled to a large 2 1/4" aluminum diaphragm which has tangential compliance. A mechanical phasing plug (pole piece) with two exponential acoustic slots is used to guarantee a proper phase relationship between the sound emanating from the center and outer edge of the diaphragm and the voice coil assembly, assuring maximum high frequency reproduction with remarkably uniform response.

The dual full-section dividing network provides frequency division and a variable rotary control mounted on the front of the cabinet permits high frequency shelving from 0 to -10 db. Encased in a compact but efficient bass-reflex cabinet designed for wall-mounting, the Altec 844A Monitor measures 31" wide by 24" high by 16" deep, and is finished in a light studio gray.



A Division of *LSPT* Ling Altec, Inc.

1515 S. Manchester Ave., Anaheim, Calif.
New York

SPECIFICATIONS

Power:	30 watts
Frequency Response:	From 30 to 22,000 cycles
Impedance:	Designed to operate from 8 or 16 ohms
Pressure Sensitivity:	99 db SPL at 4 ft. from 1 watt*, or 114 db SPL at 4 ft. from 30 watts
Horizontal Distribution:	90°
Vertical Distribution:	40°
Crossover Network:	800 cycles, dual full-section (furnished with speaker)
Cone Resonance:	30 cycles
Voice Coil Diameter:	3 inches
Magnets —	
Type:	Alnico V
Weight:	(HF) 0.81 lbs (LF) 1.8 lbs each
Structure Weight:	(HF) 5.63 lbs (LF) 9.44 lbs each
Flux:	(HF) 13,000 Gauss (LF) 10,000 Gauss
Dimensions:	31" W x 24" H x 16" D
Finish:	Gray lacquer
Weight:	90 pounds

*measured 4 feet from mouth of horn over warble frequency range 600 - 2,500 cps. (Ref.: 0.0002 dynes/cm² for 1 watt input.) EIA rating of 52 db at 30 ft. from 1 milliwatt.

ARCHITECTS AND ENGINEERS SPECIFICATIONS

The speaker system shall be of the two-way type. The frequency response shall be uniform from below 30 to above 22,000 cycles per second.

The low-frequency section shall employ two (2) 12-inch, cone-type loudspeakers mounted within an enclosure whereby the rear loading shall be provided by a bass-reflex design principle. The low-frequency section shall reproduce from 30 to a crossover frequency of 800 cycles per second. The voice coil shall be approximately 3" in diameter and shall be of edge-wound copper ribbon operating in a magnetic field of at least 10,000 Gauss derived from an Alnico V magnet weighing 1.8 pounds minimum. The free-air resonance of the speaker shall not be greater than 30 cycles, and it shall have a frequency response capability ranging from 30 to 4,000 cycles.

The high frequency section shall consist of a compression-type driver coupled to a straight cast aluminum sectoral horn with exponential expansion and straight throat. Horns employing bends, or of non-metallic construction shall be unacceptable under this specification; nor shall folded or re-entrant type horns be acceptable because of their inherent tendency toward phase shift. The horn shall provide uniform coverage over a horizontal angle of 90° and a vertical angle of 40°. It shall produce a uniform sound pressure level of 114 db at 30 watts when coupled to the high-frequency driver. The driver shall utilize a 2¼" diameter aluminum diaphragm having tangential compliance, coupled to a voice coil of edge-wound aluminum ribbon having a diameter of 1¾". The voice coil gap shall have a flux density of at least 13,000 Gauss, produced by a magnet structure having a weight of 5.63 pounds. A machined phasing plug, which also serves as the pole piece, having two exponential acoustic slots, shall be utilized to provide the proper phase relationship between the sound emanating from the center and edges of the diaphragm and voice coil assembly, thus insuring maximum high frequency reproduction while maintaining a smooth overall response. The entire diaphragm and voice coil assembly shall be field replaceable without special tools or skills. This shall be interpreted to mean that the speaker shall incorporate self-centering dowels to insure proper spacing and alignment of the diaphragm and voice coil assembly. The frequency response of the high-frequency driver shall be uniform over the range of 800 to 22,000 cycles.

Proper phasing of the high and low frequency elements shall be provided at all frequencies. The crossover between the two sections shall be at 800 cycles derived by means of a dual full-section dividing network having variable high frequency shelving from 0 to -10 db.

The loudspeaker system shall have a continuous power rating of 30 watts, and shall be designed to operate from 8 or 16 ohms impedance. The dimensions of the system shall not exceed 31 inches in width, 24 inches in height, and 16 inches in depth; and shall be encased in a cabinet designed for wall mounting and having a gray lacquer finish.

Any loudspeaker system not meeting these requirements shall not be acceptable under this specification.

The speaker system shall be the Altec Lansing model 844A.

NOTICE
We recommend that you obtain your Altec products from factory trained authorized Altec Sound Contractors and Distributors. This will assure you of proper installation, a continuing source of knowledgeable advice, service, and quick warranty protection.

604E Super **DUPLEX** Loudspeaker

604E

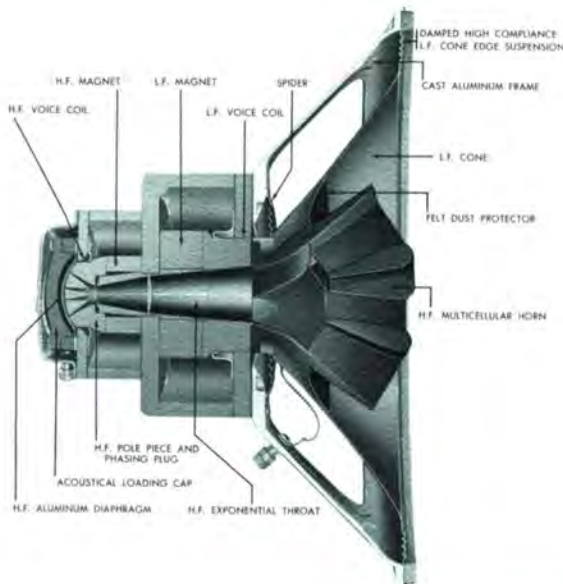

Features:

- Recording and Broadcast **PLAYBACK** Quality
- Excellent Mid-Range Frequency Response
- DUPLEX** (two-way coaxial speaker)
- Highest Efficiency
- From 20 to 22,000 cycles Frequency Range
- Dual Magnetic Structures
- Edge-Wound Voice Coils
- High Power Handling Capacity
- Dual Full-Section Precision Crossover Network
- Heavy Cast Frame Construction
- Smooth Uniform Response
- Low Cone Resonance
- Field Replaceable HF Diaphragm and Voice Coil
- Wide Angle 40° x 90° Distribution
- Multicellular HF Horn
- Compression HF Driver

PROFESSIONAL RECORDING AND BROADCASTING STUDIO MONITORING
PLAYBACK QUALITY SOUND SYSTEMS... AUDITORIUMS... RESTAURANTS
SCHOOLS... FACTORIES... SHOPPING CENTERS... TRANSPORTATION TERMINALS
NIGHTCLUBS... PUBLIC ADDRESS SYSTEMS

For twenty years Altec 604-type Duplex® speakers — long acclaimed by professional sound engineers as THE standard coaxial speaker for the audio industry — have made high fidelity history in recording and broadcasting studios. Now, Altec has incorporated two decades of experience and progress with the most recent research advances, the newest engineering developments, and the latest laboratory refinements to produce a contemporary **PLAYBACK** version of those famous 604-type speakers: The Altec Super Duplex 604E.

This fifteen-inch, coaxial speaker encompasses frequencies from 20 to 22,000 cycles, a range that extends beyond the normal scope of the human ear. Unlike many speakers which concentrate on extremely high or low frequency reproduction to the detriment of the intervening sound spectrum, particularly the important middle range which contains some 90% of all musical sounds, the Super Duplex provides unusually uniform and pure response throughout the mid-frequency range as well as those frequencies at the edge of hearing. The unique use of a machined phasing plug with two exponential acoustic slots insures a proper phase relationship between the sound emanating from the center and outer edge of the high-frequency diaphragm, resulting in exceptional and smooth mid- and high-frequency range reproduction. The high power capacity (35 watts), minimal distortion, extremely wide range, excellent sound distribution, and smooth response of the Super Duplex will meet the demands of studios so discriminating that they tolerate no compromise between the original performance and the reproduced sound.

A two-way, coaxial transducer, the Super Duplex 604E consists of a single frame containing both the high- and low-frequency speakers; magnetically, electrically and mechanically independent units. The 604E has a dual magnet structure weighing 26 pounds, 13 ounces which contains oversize Alnico V magnets. The high frequency section utilizes an edge-wound aluminum voice coil on a large (2¼ inch) aluminum diaphragm with tangential compliance coupled to a heavy, high-impact, multicellular horn with a 40° by 90° distribution angle. The low-frequency cone is driven by an edge-wound 3-inch copper voice coil and is of high compliance with cloth surround rim and apex (spider) suspension.

A dual full-section dividing network with a crossover frequency of 1,500 cycles has a high frequency shelving control with a 0 to -10 db range for correctly matching and adjusting the acoustical characteristics to any listening area.

The 604E may be mounted in a functional studio monitoring enclosure (Altec 857A) for recording and broadcast studio monitoring purposes. For home use the Altec 858A "Carmel"-type cabinet or the new Altec 855A "Malibu" furniture-styled enclosures are recommended. For detailed information on other members of Altec's family of Duplex® speakers, see the descriptive literature on model numbers 601, 602 and 605.



A Division of *LSPT* Ling Altec, Inc.

1515 S. Manchester Ave., Anaheim, Calif.
New York

ALTEC 604E

SPECIFICATIONS

Power:	35 watts (50 watts peak)	Structure Weight:	(LF) 20.31 pounds (HF) 6.5 pounds
Frequency Response:	From 20 to 22,000 cycles	Flux:	(LF) 13,000 Gauss (HF) 15,500 Gauss
Pressure Sensitivity:	101 db SPL at 4 ft. from 1 watt* or 116.4 db SPL at 4 ft. from 35 watts	Crossover Network:	1,500 cycle, dual full-section (furnished with speaker)
Impedance:	Designed to operate from 8 ohms or 16 ohms	Terminals:	Binding post (4)
Cone Resonance:	25 cycles	Diameter:	Baffle opening—13 $\frac{1}{4}$ inches Mtg. Bolt. Cntrs.—7 $\frac{3}{8}$ inches (8, equally spaced at 45°) Depth—11 $\frac{1}{8}$ inches
Voice Coil Diameters:	(LF) 3 inches (HF) 1 $\frac{3}{4}$ inches	Weight:	34 pounds (including network)
Horizontal Distribution:	90°	Finish:	White and Grey
Vertical Distribution:	40°	Accessories:	Altec 100A Bass Energizer
Magnets —		Enclosures:	Altec 855A, 857A, 612A, 614A Cabinets
Type:	Alnico V		
Weight:	(LF) 4.4 pounds (HF) 1.2 pounds		

*equivalent to EIA rating of 54 db at 30 feet from 1 milliwatt

ARCHITECTS AND ENGINEERS SPECIFICATIONS

The loudspeaker shall be 15 $\frac{1}{8}$ inches in diameter and of the two-way Duplex type, having a continuous power rating of 35 watts and a peak power rating of 50 watts. The loudspeaker shall be capable of reproducing a frequency range from 20 to 22,000 cycles per second and shall have a minimum pressure sensitivity of 116.4 db SPL at 4 feet from 35 watts, measured on axis. The loudspeaker shall employ a dual full-section dividing network having a 1,500 cycle crossover frequency and a continuously adjustable shelving control with a range of 0 to -10 db of high frequency attenuation.

The loudspeaker shall be designed to operate from 8 ohms or 16 ohms impedance. The low frequency cone shall have a free air resonance frequency of 25 cycles per second; the LF voice coil shall be of edge-wound copper ribbon having a diameter of 3 inches and shall operate in a magnetic gap having a flux density of 13,000 Gauss, produced by a magnetic structure having a weight of 20.31 pounds. The outer edge (rim) of the LF cone shall utilize a high-compliance, mechanically-damped, cloth surround which, complemented by the correct apex suspension (spider) shall be capable of reproducing the stated low frequency response.

The high frequency section of the speaker shall be a 2 $\frac{1}{4}$ " aluminum diaphragm having tangential compliance and shall be properly loaded, acoustically, by a multicellular horn, and shall utilize a machined phasing plug (i.e., pole piece) having two exponential acoustic slots to provide the proper phase relationship between the sound emanating from the center and outer edge of the diaphragm and voice coil assembly. The frequency distribution pattern of the loudspeaker achieved by use of the multicellular horn shall be 90° by 40°. The HF voice coil shall be of edge-wound aluminum ribbon, having a diameter of 1 $\frac{3}{4}$ inches, and shall operate in a magnetic gap having a flux density of 15,500 Gauss, produced by a magnetic structure having a weight of 6.5 pounds. Total magnetic structure weight shall be no less than 26 pounds. High frequency diaphragms having annular compliances and/or utilizing horns with spherical radiation patterns shall be deemed unacceptable under this specification.

The loudspeaker frame shall be of heavy cast construction. The high frequency diaphragm and voice coil assembly shall be field replaceable without the use of special tools or skills. This shall be interpreted to mean that the loudspeaker shall incorporate self-centering dowels to insure proper spacing and alignment of the diaphragm and voice coil assembly.

Any loudspeaker not meeting all of the foregoing requirements shall be deemed unacceptable under this specification.

The loudspeaker shall be Altec Lansing Model 604E.

70 & 25 Volt Line Transformers

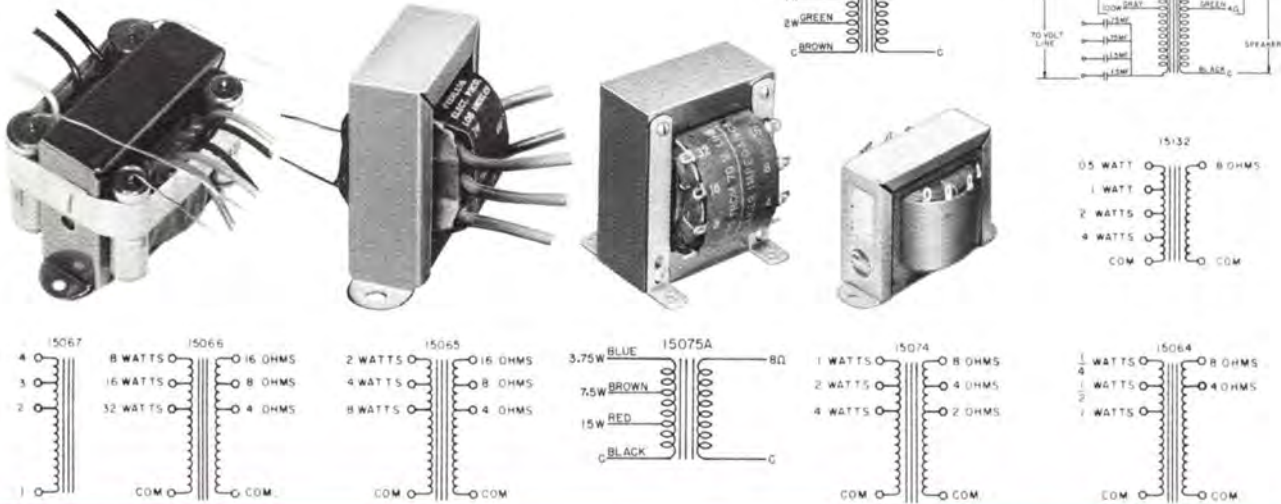

Features:

- Superior quality by Peerless
- Lower insertion loss
- Full rated power within 1 db over entire frequency range
- Selectable wattage to speaker
- .25 to 130 watt power range
- Size for every need
- Variable High-Pass Filter (Model 15045A)

ALTEC 70- and 25-volt line transformers are provided for the many needs in sound power distribution to loudspeakers. The 70-volt system is very popular due to its convenience, efficiency, and economy, permitting an immediate selection of the needed power for each speaker without lengthy computation of impedances to obtain the desired figure. The 70-volt system provides a maximum of efficiency without loss of expensive power in resistive networks; low line losses are maintained while line conductors are of economical gauge. The 25-volt system is required in buildings used for certain purposes.

The mid-range losses listed in the tabulation for the transformers are *maximum*; the actual loss differs with the taps used and, for most taps, is *less* than the value listed. These represent outstanding efficiencies, achieved through liberal design based on grain-oriented steel, resulting in the saving of costly amplifier watts and the reduction of the cost per watt delivered to the speaker.

INSTALLATION & OPERATION:

The 70.7 volt line distribution system operates as follows:

1. A transformer is required for each loudspeaker or speaker system; the secondary of the transformer accommodates the loudspeaker impedance and is marked in ohms. (Frequently it is possible to use a single transformer for two neighboring speakers.)
2. The primary of the transformer is tapped over a suitable range of impedances, each of which draws a different amount of power from the 70-volt line, just as electric light bulbs with different resistances draw different amounts of power from a 117-volt circuit. The transformer 70-volt impedance can be calculated from the formula $R = \frac{E^2}{W}$ or, for 70-volt systems, $R = \frac{70.7 \times 70.7}{W}$ or $R = \frac{5000}{W}$ (Example: a 10-watt tap would have an actual impedance, R , of about 500 ohms). The primary taps are marked in watts; use the tap corresponding to the speaker power required for the location served.
3. The selected primary terminals of all transformers are connected to the 70-volt line from the amplifier.



A Division of LSPV Ling Altec, Inc.

1515 S. Manchester Ave., Anaheim, Calif.
New York

CONNECTIONS:

The loudspeaker side (secondary) of the matching transformer has taps marked in *ohms*, corresponding to the impedance of the speaker voice coil; the amplifier side, (primary) has taps marked in *watts*, corresponding to the input wattage desired for each speaker. Connections for 70-volt line operation are made as follows:

1. The speaker terminals are connected to the correct *ohms* tap and the common ("C") tap on the transformer secondary.
2. The 'high' side of the 70V output from the amplifier is connected to the desired "W" (watts) tap; the 'low' side to the common ("C") tap on the transformer primary.

By adding the total wattage needed for all loudspeakers, the power requirements of the amplifier are determined. This total should not exceed the amplifier rating.

ALTEC MODEL 15045A LINE TRANSFORMER:

Many applications require the attenuation of low frequencies in order to prevent damage to the diaphragms of horn driver loudspeakers, resulting from excessive excursion. In the past, dividing networks have been the only means available for such a purpose, resulting in increased cost together with difficulties in physical mounting and impedance matching.

With the introduction of the ALTEC 15045A 70-volt line transformer and high pass filter, the functions of line matching and correct low frequency cut-off have been combined in a single unit — easily mounted within the weatherproof housing of the ALTEC 50A, 290D, and 730B driver loudspeakers and horn system — providing a variable high-pass filter with sharp cut-off characteristics beginning at 300 to 500 cycles.

The 15045A consists of a special 70-volt line transformer, together with four capacitors, two large and two small units (2 - 1.5mfd; 2 - .75mfd), firmly affixed to the transformer frame. The lower lead of each capacitor is internally connected to one of two lugs which, in turn, are connected to the primary common lead. Wire nuts are supplied with the 15045A to facilitate connection.

In practice, the single leads (i.e., those not attached to the primary common side of the transformer) from the capacitors are connected to the 'low' side of the 70-volt amplifier output; the 'high' side of the amplifier is then connected to the desired wattage tap on the transformer primary. A great range in both speaker power and cut-off frequency is available by making the proper connections, as shown in the following table:

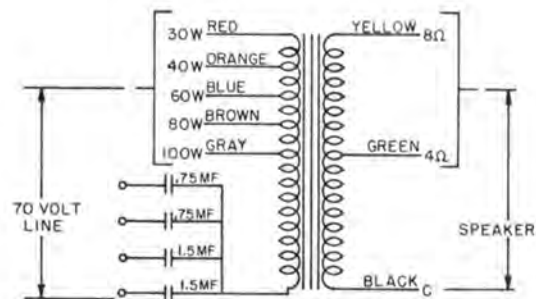

70-VOLT LINE CONNECTION

DESIRED POWER	LF CUT-OFF	LEAD COLOR	CAPACITORS
100 watts	450 cps	Gray	All
80 watts	500 cps	Brown	2 large; 1 small
80 watts	350 cps	Brown	All
60 watts	500 cps	Blue	2 large
60 watts	300 cps	Blue	All
40 watts	500 cps	Orange	1 large; 1 small
40 watts	300 cps	Orange	2 large
30 watts	300 cps	Red	1 large; 1 small

Frequency response of the ALTEC 15045A transformer is uniform (± 1 db) from selected cut-off to 10,000 cycles; maximum insertion loss (above cut-off region) is 0.5 db.

ALTEC MODEL 15064:

This model, the smallest of the ALTEC 70-volt line transformers, is designed for mounting directly on the frame of the ALTEC 401B loudspeaker. The 4-ohm secondary impedance allows the use of a single transformer for two speakers.

Frequency response:	± 1 db 60-15,000 cycles
Insertion loss:	0.7 db maximum
Primary watts:	1, 0.5, 0.25
Secondary impedance:	4 and 8 ohms

ALTEC MODEL 15065:

The 15065 represents the smallest ALTEC full-range 70-volt line transformer.

Frequency response:	± 1 db 30-15,000 cycles
Insertion loss:	0.5 db maximum
Primary watts:	8, 4, and 2
Secondary impedance:	4, 8, and 16 ohms

ALTEC MODEL 15066:

The 15066 has characteristics similar to those of the 15065 (above) but with greater power handling capability.

Frequency response:	± 1 db 30-15,000 cycles
Insertion loss:	0.5 db maximum
Primary watts:	32, 16, and 8 watts
Secondary impedance:	4, 8, and 16 ohms

ALTEC 15067 AUTO TRANSFORMER:

The heavy-duty, versatile, ALTEC 15067 auto transformer may be used in 70- or 140-volt lines, or for other impedance translation purposes. Its adaptability to a range of impedances results from the fact that its frequency response is much wider than its rated 30 to 15,000 cps. Insertion loss is a maximum of 0.3 db, in 70-volt use, at the least favored impedance tap. Operating maxima are 2.2A anywhere in the winding and applied voltage depends on the lowest applied frequency. EXAMPLE: (max. power) = (max. applied voltage) × (max. input current.)

SOURCE TERMINALS	LOAD TERMINALS	MAXIMUM SOURCE VOLTAGE AND POWER		MAX. LOAD CURRENT	IMPED. RATIO	VOLTAGE RATIO
		30 cps min.	60 cps min.			
1 - 4	1 - 2 or 2 - 4	70v@150w	140v@600w	4.4A	1:¼	1:½
1 - 4	1 - 3	70v@150w	140v@600w	3.1A	1:½	1:0.7
1 - 4	3 - 4	70v@50w	140v@200w	2.9A	1:¾	1:¼
1 - 3	1 - 4	50v@150w	100v@600w	2.2A	2:1	1.4:1
1 - 2 or 2 - 4	1 - 4	35v@150w	70v@600w	2.2A	4:1	2:1
3 - 4	1 - 4	17.5v@50w	35v@200w	0.75A	16:1	4:1

"Impedance" is the minimum permitted load impedance in 70-volt use.

Example (Line 1 of chart): Terminals 1-3 may be 16 ohms or more down to 30 cps with 70 volts at 1-4 (or 32 ohms in 140-volt service down to 60 cps.) If 1-3 is connected to 16 ohms, then the impedance of 1-4 will be 16×2 (Impedance ratio) or 32 ohms; load voltage $70 \div 1.4$ or 50 volts, and load current $50 \div 16$ ohms or 3.1a.

Maximum current permitted in any part of the winding, 2.2 amperes; maximum applied voltage varies with the lowest frequency as shown in the above table.

High reactance at 30 cps permits coupling with another 15067:

1. Parallel (Fig. 1) matches 70-volt, 260-watt line to 4 or 8 ohms.
2. Series (Fig. 2) for matching a 140-volt, 260-watt line to 16 or 32 ohms.
3. Cascade (Fig. 3) for matching a 70-volt, 80-watt line to 8, 16, or 32 ohms.

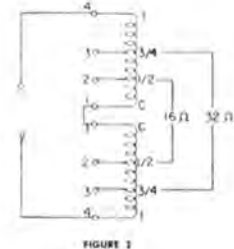
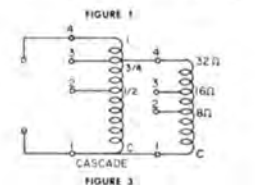
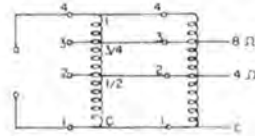

ALTEC MODEL 15074 70-VOLT LINE TRANSFORMER:

This unit, while rated as a four watt transformer, is actually a multi-purpose component, having nominal secondary impedances of 2, 4, or 8 ohms, together with nominal primary wattages of 4, 2, and 1 watts when connected to a 70-volt line. Under rated conditions of operation, the frequency response is flat (± 1 db) from 60 to 15,000 cycles, with a maximum insertion loss of 1.2 db.

The two optional modes of application are as follows:

1. When the transformer is loaded with twice its nominal impedance:
 - (A) The secondary impedances are considered as 4, 8, or 16 ohms.
 - (B) The corresponding power drawn from the line becomes 0.5, 1, and 2 watts, respectively.
 - (C) Maximum operating insertion loss is then 0.8 db.
2. When the transformer is loaded with four times its nominal impedance:
 - (A) The secondary impedances are then considered as 8, 16, and 32 ohms.
 - (B) The corresponding power drawn from the line becomes 0.25, 0.5, and 1 watt, respectively.
 - (C) Maximum operating insertion loss is then 0.5 db.

No impairment of frequency response occurs when either of the two optional modes of application, above, are employed. The ALTEC 15074 transformer may be mounted directly on the ALTEC 401B loudspeaker.

ALTEC MODEL 15132:

The ALTEC model 15132 70-volt line transformer is designed primarily for mounting on the ALTEC 403A loudspeaker or for installation wherever a low-power, 8-ohm unit is needed:

Frequency response: ± 1 db 100-10,000 cycles
 Insertion loss: 1.0 db maximum
 Primary watts: 4, 2, 1, 0.5 watts
 Secondary impedance: 8 ohms

ALTEC MODEL 15075A

The ALTEC model 15075A 70-volt line transformer is designed to mount directly on the frames of the ALTEC 50A horn and 730B driver units. The 15075A is shipped with a plastic loop support, two mounting screws, and two lockwashers.

Frequency response: ± 2 db 200-15,000 cycles
 Insertion loss: .6 db maximum
 Primary wattage: 15, 7.5, 3.75 watts
 Secondary impedance: 8 ohms

ALTEC MODEL 15230 25-VOLT LINE TRANSFORMER:

In many instances, the ALTEC 1556A "Altalk" Amplifier will be employed in sound distribution and paging systems, permitting the usage of lower voltage (25VAC) in the speaker lines. This is especially desirable in installations where a potential hazard, however remote, may exist, should a standard (70V) system be used. The ALTEC 15230 transformer provides the advantages of a 70-volt system, but with substantially lower speaker line voltage.

Frequency response of the 15230 is uniform (± 2 db) from 100 to 5000 cycles; maximum insertion loss is 1.0 db. The unit provides primary wattage taps of 2, 1, 0.5, and 0.25 watts; secondary impedance is 8 ohms.

70 & 25 Volt Line Transformers

SPECIFICATIONS

(a) Type Number	(b) Frequency Range (1 db)	(c) Audio Watts Primary	(d) Secondary Load Imp (ohms)	(e) ² Maximum Insertion Loss Db	Termination	Wt/lbr
15132 ^{1,7} (For 403A Loudspeakers)	100 10,000	4,2,1,.5	8	1.0	7 Leads	1/2
15064 ^{1,4}	60 15,000	1,.5,.25	8,4	.7	7 Solder Terms	3/8
15074 ^{1,4}	60 15,000	4,2,1 or 2,1,.5 or 1,.5,.25	8,4,2 or 16,8,4 or 32,16,8	1.2 or .8 or .5	8 Solder Terms	5/8
15065 ¹	30 15,000	8,4,2	16,8,4	.5	8 Solder Terms	2 1/4
15066 ¹	30 15,000	32,16,8	16,8,4	.5	8 Solder Terms	5
15075A ^{2,3}	200-15,000	15, 7.5, 3.75	8	.6	6 leads	1/2
15067 ¹ (auto- transformer)	30 15,000	160 or 80	16,8 or 32,16	.3 or .2	4 Solder Terms	5 3/4
		or, for impedance matching at other than 70 volts:				
		80 or 40	16,8,4 or 8,4,2	.5 or 1.0		
15045A ^{1,6,8}	to 10,000	100, 80, 60, 40, 30	4, 8	0.5	6 leads	2 1/2
15230 ³ (25-volt line only)	100-5,000	2, 1, 0.5, 0.25	8	1.0	5 leads	5/8

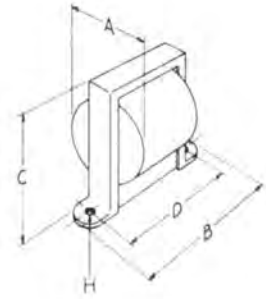

Figure 1.

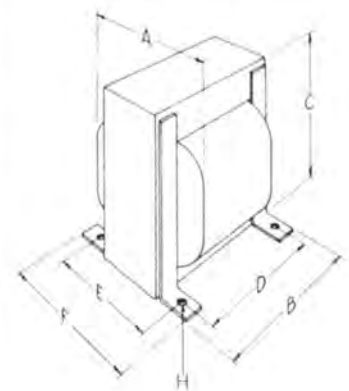

Figure 2.

1. Rated full power within 1 db over frequency range.
2. Insertion loss for most unfavorable combinations of impedances.
3. Frequency deviation of these units varies a maximum of ± 2 db.
4. May be mounted directly on 401A Loudspeaker.
5. May be mounted directly on 50A and 730B Horn Systems.
6. Variable low-frequency cutoff.
7. May be mounted directly on 403A Loudspeaker.
8. May be mounted directly on 290D, 730B, or 50A Horn Systems.

TABLE OF DIMENSIONS

TYPE NO.	FIGURE NO.	A	B	C	D	E	F	H
15132	Fig. 1	1 1/2	2 3/8	1 15/16	2			3/16 Dia Holes
15064	Fig. 1	1 9/16	2 3/8	1 3/8	2			3/16 Dia Holes
15074	Fig. 1	1 5/8	2 3/8	1 15/16	2			3/16 Dia Holes
15075A	Fig. 1	2 1/4	4	2 3/8	3 3/8			3/16 Dia Holes
15065	Fig. 1	2 5/8	4	2 5/8	3 3/8			3/16 Dia Holes
15045A	Fig. 1	2 1/2	4	2 5/8	3 3/8			3/16 Dia Holes
15066	Fig. 2	3	3 1/8	3 3/4	2 5/8	2 1/2	3 1/8	3/8 x 5/16
15067	Fig. 2	3	3 1/8	4 1/4	2 3/4	2 5/8	2 7/8	3/8 x 5/16
15230	Fig. 1	1 1/2	2 3/8	1 15/16	2			3/16 dia. holes

ARCHITECTS & ENGINEERS SPECIFICATIONS

(NOTE: After selecting transformer, insert proper values as shown in above specifications and fill in blank spaces where required.)

The transformer shall deliver within 1db of its full rated power over the entire range of (b) cycles with an insertion loss not greater than (e) db for the most unfavorable impedance combination. The primary shall be labeled in terms of power of (c) watts delivered to the load when the transformer is connected to a (70-volt) (25-volt) line, and the secondary shall be tapped for (d) ohm loads.

(NOTE: Insert following ammenda if high-pass filter action is desired.)

The transformer shall have a low-frequency cut-off of () cycles at () watts for adequate protection of horn driver elements from potential damage by low frequencies; the transformer shall be ALTEC model 15045A.

NOTICE
 We recommend that you obtain your Altec products from factory trained authorized Altec Sound Contractors and Distributors. This will assure you of proper installation, a continuing source of knowledgeable advice, service, and quick warranty protection.



MICROPHONES • AMPLIFIERS

CONTROL CONSOLES • LOUDSPEAKERS

HORNS • AM-FM TUNERS

SCIENTIFIC INSTRUMENTS • THEATRE SYSTEMS

PUBLIC ADDRESS SYSTEMS

STEREO AND MONO HIGH FIDELITY SYSTEMS

TELEPHONE AND INTERCOM TRANSMISSION EQUIPMENT

TRANSFORMERS

If You Didn't Get This From My Site,
Then It Was Stolen From...