

# COLUMBIA

# Electronic Sales

SERVING THE ELECTRONIC INDUSTRY SINCE 1946

EXPORTERS • AIRCRAFT • AMATEURS • HOBBYISTS • INDUSTRIAL • COMMERCIAL • HOBBYISTS

DEALERS  
MARINE



COLUMBIA ELECTRONIC SALES  
2251-53 WEST WASHINGTON BOULEVARD • LOS ANGELES 18, CALIFORNIA • REPUBLIC 1-2206

AIRCRAFT-RADAR EQUIPMENT • SURPLUS RADIO PARTS & SUPPLIES • SHORAN • LORAN

Dear Friend:

"WHY BUY ELSEWHERE--WHEN COLUMBIA UNDERSELLS EVERYBODY?"  
You've seen that slogan featured in our ads. Now take a look at this all-new catalog...and see for yourself how we back it up!

In this spanking new publication, you'll find more variety, more features, more specials, more items....at lower prices....than we or anyone else ever offered before.

The reason? COLUMBIA'S E-X-P-A-N-S-I-O-N.....that's why!  
As of November of last year, in addition to maintaining our present facility in Los Angeles, we opened a new branch in the San Fernando Valley at 4900 Lankershim Blvd., North Hollywood, California. That expansion was made possible by the loyalty of our thousands of domestic and foreign customers--and don't think we'll ever forget it.

But this is even more important! By doubling our facilities, we doubled our inventory and tripled our buying power....which puts us in a better position to offer you bigger savings than ever before.

Of special importance to the "industrial buyer" is the fact that fifty percent of our North Hollywood branch is devoted to warehousing quarters, amply stocked with commercial electronics of all varieties running into the tens of thousands of dollars in value, with trained personnel facilitating all export orders.

This means that we are in an excellent position to service foreign governments, importers as well as domestic dealers, hams, exporters and industrial buyers.

Any way you look at it, you can't do better, buy more, or pay less anywhere--than you can at COLUMBIA. Like it says in the ad: "COLUMBIA UNDERSELLS EVERYBODY!"

Sincerely yours,  
*Ken Saker K6KBJ*  
President

LBS:ra

AIRCRAFT INSTRUMENTS • TEST EQUIPMENT • AN CONNECTORS • MARINE • ALTIMETERS  
SIMULATORS • METERS • REPLACEMENT PARTS

COLUMBIA'S WORLD WIDE

SALES EXCEL

WORLD CAPITAL FOR RADIO EQUIPMENT

WHY BUY ELSEWHERE  
COLUMBIA  
UNDERSELLS EVERYONE!



# SAVE! TRANSISTOR RADIOS SAVE!

**Fantastic BUY!**  
 AN EXAMPLE OF Columbia's  
**FABULOUS BUYING POWER!** **\$32.50**  
**8 TRANSISTORS**  
**AMERICAN MADE** BATTERIES EXTRA  
 4 FOR -40¢  
 MODEL No. SUPER EIGHTY  
 8 - TRANSISTORS, PRINTED CIRCUIT CHASIS  
 HI-IMPACT POLYSTYRENE CASE, POWERED BY  
 4 - PENLITE BATTERIES, JACK FOR EAR PHONE,  
 EASEL BACK **BLK.-WHITE-CORAL-GOLD TRIM**



NTR5

**Exclusive Reflex Circuit**  
**Gives the Finest Sound**  
**Reproduction of all Four**  
**Transistor Radio Receivers**



**\$23.95**  
**WITH BATTERY**  
**AND**  
**PERSONAL**  
**HEAD PHONE**

**POCKET SIZE** EASY TUNING  
 This 2½" x 4" x 1¼"

**REFLEX CIRCUITRY** **HI-IMPACT CASE**

**NEW COLORS**  
 Now you can enjoy your favorite decorator colors: Beige, Lemon, Grey, Black. All with harmonizing Gold escutcheon plate.

**ZEPHYR** MODEL GR-606

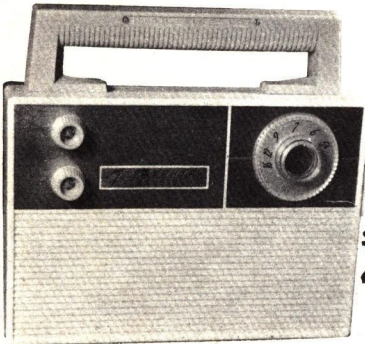

**\$44.95**

WITH BATT.

7 TRANSISTORS 2 VARISTORS  
 ANTENNA TONE CONTROL  
 Large 7" Ferrite type, placed in handle

**3** Super-Phonic Speakers to fill your living room with living sound. Two 3" speakers in front and one 3" speaker in rear of cabinet.  
 Up to 6 months service on 6 standard "C" size flashlight cells.

**TWO-TONE COLORS**

CORAL & WHITE CHARCOAL & WHITE GOLD TRIM  
 JADE & GREEN BEIGE & WHITE ALL TRIM

**Zephyr** MODEL 5P51

AC DC or BATTERY

**PLUS!** NEW STYLE TUBE TO INSURE LONG BATTERY LIFE

**PLUS!** 3-GANG TUNER FOR FRINGE AREA RECEPTION

Clean, functional, compact—only 11" x 4" x 3". Designed for indoor use as well as outdoor—as a plug-in set as well as a battery set.

Earphone and batteries are included.

Choice of Butter Cup Yellow, Sea Foam Green, Sand Beige and Charcoal.

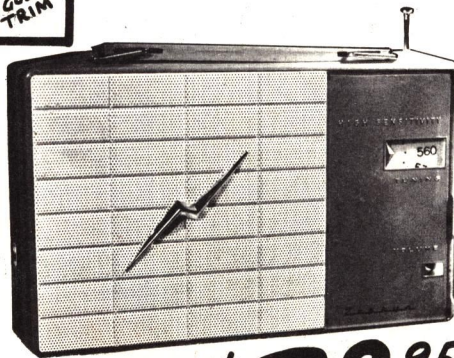

**\$28.95**

**ZEPHYR** Portable  
 In Glowing Jewel Tones

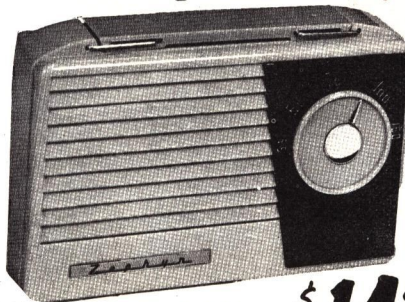

MODEL RN7 **\$14.95**

A pint-sized portable with amazing "pull-in" power and big radio tone quality. Slim-line design makes for true portable compactness. Styled with eye appeal **BLUE RED YEL GR.**  
 (Includes batteries and earphone for private listening.)



MODEL GR-3T6

6  
**TRANSISTOR**  
**RADIO**  
**SPECIAL**



- No tubes—no wires—new printed circuit.
- Built-in antenna—super quick starting.
- Big superphonic speaker—bell clear tone.
- Operates for months on one low cost battery.
- Small, lightweight—less than 4" x 1¼" x 2¼".
- Non-breakable Hi-Impact case.
- Fits easily into pocket or purse.
- Choice of four glorious colors.

**\$27.95**

\* complete with earphone, battery and **LEATHER CARRYING CASE!** **\$29.95**  
CASE ONLY

## COLUMBIA ELECTRONIC SALES MAIL ORDER DEPT.

WHOLESALE - RETAIL STORE  
 2251 WEST WASHINGTON BLVD.  
 LOS ANGELES 18, CALIFORNIA • REpublic 1-2206  
 OPEN MON. & FRI. TILL 9:00 P.M. - SAT. 9 TO 5:30

SAN FERNANDO VALLEY RETAIL STORE  
 and WHOLESALE WAREHOUSE  
 4900 LANKERSHIM BLVD.  
 NORTH HOLLYWOOD, CALIFORNIA • Stanley 7-2113 - POplar 6-8668  
 OPEN 9 TO 9 WEEKDAYS - SAT. 9 TO 6



# Hi-Fi COMPONENTS

## STEREO AMPLIFIER

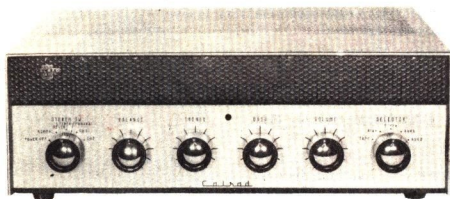

### SPECIFICATIONS

Circuits: 2—ECL82's self biased, pentode connected in push-pull per channel. (4 total).

Output Level: 12 watts at less than 1% harmonic distortion (1000 c.p.s.), 2% 1M (60/6000 c.p.s. per channel).

Peak Power Output: 15 watts per channel, 30 watts combined.

Output Impedance: 4, 8 and 16 ohms. per channel.

Frequency Response:  $\pm 0.5$  db 20 - 30,000 c.p.s. at 1 watt.

Hum: Minimum volume: 80 db below 12 watts. Tuner and Aux. (Hi-Level): 70 db below 12 watts (0.5 v. input reference).  
Phono (RIIA Position): 60 db below 12 watts (6 mv input reference).  
Tape Input: 55 db below 12 watts (1 mv. input reference).

Cross Talk: Better than 50 db.

Tone Control Range:  $\pm 12$  db at 50 c.p.s.  
 $\pm 12$  db at 10,000 c.p.s.

Input Levels: Aux and Tuner (Hi-Level) 200 millivolts, 500 Kohms, flat response.  
Phono (Mag): 3 mv at 1 KC. Will not overload with input level below 180 mv.  
Tape: 1 mv at 1,000 c.p.s.

## Calrad SA-30 Stereo Amplifier

A two channel 15 watt, monaural 30 watt stereo amplifier designed to perfection in audio amplification. Professional in performance and appearance and dedicated to the most critical listener demanding the finest regardless of cost. The specifications of this amplifier make it one of the finest products in the audio trade. Never before has so many features appeared in any one amplifier.

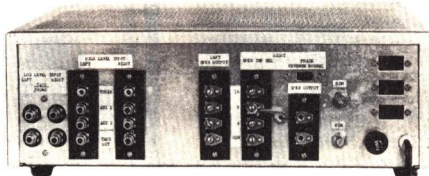

Tape Output Level: 1 volt from each channel, unmodified by volume controls.

Record Equalization: RIAA

Tape Equalization: NARTB

Tube Complement: (Total 8) 1—GZ34, 4—ECL82, 3—ECC83/12AX7.

Dimensions: 14 1/2" x 4 1/2" x 11 1/8"

Weight: 21 lbs.

Power Consumption: 100 watts.

**\$ 87.90**

## Calrad AP-15 Amplifier

A 15 watt audio amplifier offering definite superiority of design, construction, quality, and more important, performance. Outstanding in appearance at low cost. Built in pre-amp. Separate tone controls. Low hum level. 5 inputs plus 2 a.c. outlets.

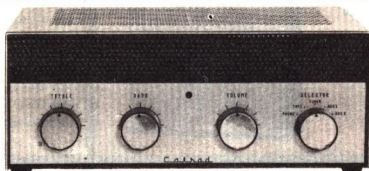

### Specification of 15Watt Hi Fi Amplifier

Circuit: 2—ECL82 (6BM8) Self biased pentode connected in push-pull Triode Section of ECL825 (6BM8) used as phase converter and voltage amplifier.  
6AU6 used as voltage amplifier  
EZ81 (6CA4) full wave rectifier

Input Terminals: Phono (Crystal) Individual switching from front panel  
Tape  
Tuner  
Aux<sub>1</sub>  
Aux<sub>2</sub>  
With 500 Kohm input Resistance  
200mV Input for maximum Output

Output: Maximum 15W  
9W Output at less than 1% harmonic distortion (1000 cps)

Frequency Response: 20 to 30,000 cps  $\pm 0$ ,  $-1$  db

Output Impedance: 4, 8 and 16-ohms

S/N Ratio:  $-65$  db or less

Power Supply: 117V 50/60 cycles

Dimension: Width, 12"; Height, 4 1/2"; Depth, 6"

Net Weight: 10 1/4 lbs.

**\$ 42.50**

## P. R. E. Pre-Amplifier

A self-powered low cost pre-amplifier to be used with low-level magnetic cartridge or microphone. Completely shielded, uses 6SC7 double triode. Can also be used with tape play back head or any standard amplifier. 3 1/4 x 3 3/8 x 3-11/16.  
(Less Tube) Cat. No. PRE

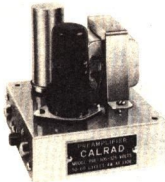

**\$ 7.95**

6SC7 TUBE 1.58

### SPECIFICATIONS

Overall Dimensions: 3 3/4" x 3 3/8" x 3-11/16" high.  
Weight: 1 1/2 pounds.  
Power Rating: 105-125 volts AC 50-60 cycles, 4 watts at 117 volts.  
Tube: Type 6SC7.  
Rectifier: Selenium type.  
Frequency Response: Uniform within 2 db from 30 to 20,000 cycles on phonograph, tape and microphone.  
Gain, Phonograph: 10 millivolts (.01 volts) input to produce 1 volt output, a voltage gain of 100.  
Gain, Tape: 5 millivolts (.005 volts) input to produce 1 volt output, a voltage gain of 200.  
Gain, Microphone: 1 millivolt (.001 volts) input to produce 1 volt output, a voltage gain of 1,000.  
Hum and Noise Level: At least 60 db below 1 volt output on phonograph and tape and at least 70 db below 1 volt on microphone.  
Equalization: Low frequency turn-over at 500 cycles (RIAA) for any magnetic cartridge, or 1600 cycles for tape head playback. High frequency equalized for particular cartridge to be used.  
Output Impedance: Output cable can be any length up to 50 feet. Operates into any amplifier with input impedance of 100,000 ohms or higher.

## 4-SPEED PROFESSIONAL TURNTABLE



- Double Reflection
- Built-in Stroboscope

### Calrad Model 1000 Professional Turntable

Motor: 4 Pole Induction Type. 110 - 117 V AC, 60 cycles only

Speeds: 4 speeds—16 2/3, 33 1/3, 45, and 78 rpm.

Speed Adjustment:  $\pm 8\%$

S/N Ratio:  $-44$  db.

Wow: Less than 0.2%

**\$ 48.95**

HARDWOOD BASE \$17.95  
SPECIFY FINISH

Specify catalog number T.T.-1000 when ordering.

## PHONO MOTOR

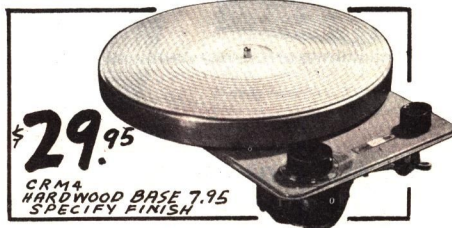

**\$ 29.95**

CRM4 HARDWOOD BASE 7.95  
SPECIFY FINISH

4 pole shaded induction motor with magnetic braking, assuring extreme accuracy of the fine speed control.

### Calrad 4 Speed Motor & Turntable Model CRM-4

One of the finest high-quality low cost turntables available offering quiet rotation. Precision built, each unit is tested for speeds under normal operating conditions. Four speeds 16 2/3, 33 1/3, 45, 78 RPM with heavy well balanced, 10-inch aluminum turntable including a beige rubber ribbed mat.

Speeds are selected by a single large knob with off position. To eliminate drive wheel pressure. A fine speed control gives  $\pm 10\%$  variation. Overall hum shield assures best performance with all types of magnetic cartridges.

Supplied complete with instructions, mounting template and aluminum stroboscope.

### SPECIFICATIONS:

Voltage: AC 117V 60 c/s

Power: 12.7VA 4-pole shaded induction motor

Speeds: 16 2/3, 33 1/3, 45, 78 RPM

Fine Speed Control:  $\pm 10\%$

Wow: Below 0.3%

Rumble: Below 45 db

Turn Table: 10 inches, 2.42 lbs.

Size: Mounting plate 7" wide x 7 3/4" deep  
Mounting depth below plate to bottom of motor 3 1/2"

Weight: 7.00 lbs.

# COLUMBIA ELECTRONIC SALES MAIL ORDER DEPT.

WHOLESALE — RETAIL STORE  
2251 WEST WASHINGTON BLVD.

LOS ANGELES 18, CALIFORNIA • REPUBLIC 1-2206

OPEN MON. & FRI. TILL 9:00 P.M. — SAT. 9 TO 5:30

SAN FERNANDO VALLEY RETAIL STORE  
and WHOLESALE WAREHOUSE

4900 LANKERSHIM BLVD.

NORTH HOLLYWOOD, CALIFORNIA • STANLEY 7-2113 — POPLAR 6-8668

OPEN 9 TO 9 WEEKDAYS — SAT. 9 TO 6



# HI-FI STEPHENS • SCOTT • BOGEN

WRITE FOR COLUMBIAS LOW PRICES ON ITEMS NOT LISTED



## NOW — TRUE PISTON ACTION!

An engineering achievement in high fidelity reproduction! Free-cone suspension means the speaker cone is mounted flexibly with a special plastic-impregnated compliance. Result: the speaker cone moves as a true piston...the cone has free excursion, eliminating distortion, giving a maximum bass response and better transient response. Here is clarity and definition of instruments and voices unsurpassed!



**WOOFER 120W**

A 12" woofer with extremely low free air resonance (30 cps) for clean bass reproduction. Using TRUSONIC free-cone construction, the cone and voice coil mass is kept to a minimum for excellent transient response. The cone is straight-sided and the voice coil is edge-wound aluminum. The low mass of the moving structure permits flat distortion-free operation to beyond 5000 cps, making this unit suitable for use with the 5KT tweeter in a compact 2-way system—as well as in more conventional systems using lower crossover points. Typical clarity of tone produced by Trusonic free-cone loudspeakers! Free air resonance: 30 cps. Voice coil diameter: 2 1/2". Frequency response: 30-5000 cps. Power rating, program: 30 watts. Power rating, peak: 60 watts. Magnet Structure: 9 1/2 lbs. Shipping wt., 15 lbs.

**\$60.00**



**WOOFER 150W**

**WOOFER 150W**

A 15" woofer of only 20 cps free air resonance, designed for use with crossover frequencies below 2500 cps. The low free air resonance is obtained without "weighting" the cone and voice coil, resulting in a low mass but stiff cone of full body and low density. Superb transients and a minimum of spurious response. The clarity of tone is characteristic of the TRUSONIC free cone speakers. Free air resonance: 20 cps. Voice coil diameter: 3". Frequency response: 20-3500 cps. Power rating, program: 35 watts; 70 watt peaks. Magnet structure: 15 lbs. Shipping wt. 25 lbs.

**\$87.50**

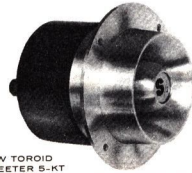

**NEW TOROID TWEETER 5-KT**

**NEW TOROID TWEETER 5-KT**  
New Toroid design adds octaves to your sound system...lets the sound grow right out of the voice coil, dispersing highs through a full 100° angle! The 5KT is a high-efficiency, low-distortion tweeter suitable for use above 5000 cps—in a two-way or three-way system. Toroid diaphragm—minimum moving mass—1 1/2" voice coil of edge-wound aluminum—solid horn structure. Complete with 5000 cps high-pass filter and adjustable brilliance control network. Frequency response: 5000-25,000 cps. Cross-over: L-C, 12 db/octave, 5000 cps. Mounting hole: 2-13/16" diameter. Mounting flange: 4" diameter. Overall length: 4 1/2".

**\$49.50**



**80 FR**

## NEW FREE CONE FULL-RANGE SPEAKERS

**80 FR** Big-speaker response designed into a rugged, compact unit. This full-range model establishes a new standard for clarity, power-handling capacity, presence and lack of distortion in an eight-inch speaker. An exclusive internal-air damping system provides a controlled cushioning to eliminate break-up at extremely high levels.

Impedance: 16 ohms (8 ohms optional). Frequency response: 40-15,000 cycles per second. Free air resonance: 50 cycles per second. Power rating: 25 watts program; 50 watts peak. Voice coil: 2" diameter, edge-wound aluminum ribbon. Magnet structure: 4 lbs. Shipping wt. 6 1/2 lbs.

**\$31.50**



**120 FR**

**120 FR** Freedom from distortion...excellent transient response...smooth musical balance! The 120FR is an extended frequency range speaker that combines all of these performance qualities in a 12-inch model—performance qualities usually associated with only the finest coaxial speakers.

Impedance: 16 ohms (8 ohms optional). Frequency response: 40-15,000 cycles per second. Free air resonance: 40 cycles per second. Power rating: 30 watts program; 60 watt peaks. Voice coil: 2 1/2" diameter, edge-wound aluminum ribbon. Magnet structure: 9 1/2 lbs. Shipping wt. 15 lbs.

**\$60.00**



**150 FR**

**150 FR** Here's a new 15-inch full-range loudspeaker with bass response more robust and full-bodied than ever before possible. The secret is an outstanding engineering achievement: free-cone suspension now in a full-range 15-inch speaker for the very first time! The 150 FR is unsurpassed in clarity of tone and faithfulness of reproduction. Impedance: 16 ohms (8 ohms optional). Frequency response: 20-14,000 cycles per second. Free air resonance: 23 cycles per second. Power rating: 35 watts program; 70 watt peaks. Voice coil: 3" diameter, edge-wound aluminum. Magnet structure: 18 lbs. Shipping wt. 25 lbs.

**\$87.50**

**YOUR PRESENT SPEAKER**

**STEREODOT\***

## STEPHENS TRUSONIC RECOMMENDED FOR STEREO

For the ultimate in stereo performance, complete ease and convenience of placement, plus a cost savings to you, we recommend the use of a single high quality, full-range Trusonic FREE CONE loudspeaker with a good bass response in conjunction with our STEREODOT\* system. This will provide you with an unparalleled true three channel stereo sound.

**\$169.50**

## BOGEN

### DB-114 MONAURAL



Compact high fidelity amplifier with full 14 watts power output at less than 0.5% distortion. For use with tuner, record player, tape recorder, etc. Peak power 34 watts.

MODEL DB-114. Net..... \$ 69.50  
AEG Cover and Legs..... 6.00

### DB-212 STEREO

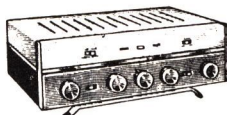

Stereophonic dual amplifier-preamplifier. With this single unit you can precisely control all stereo sources, Discs, Tapes, AM-FM broadcasts. Dual 12-watt outputs for stereo (24 watts monaural) with life-like reproduction. Peak power 48 watts.

MODEL DB-212. Net..... \$ 115.00  
BEG Cover and Legs..... 7.50

### FM-AM TUNER

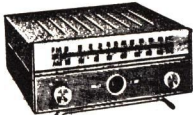

Radiation-proof FM-AM tuner incorporating highly sensitive and selective circuits.

MODEL T-661. Net..... \$ 129.50  
AEG Cover and Legs..... 6.00

### NEW FM51 BASIC FM TUNER

Exceptionally fine basic FM tuner. Has automatic frequency control to "lock in" stations, and temperature compensated oscillator to prevent drifting.

### NEW AM91 BASIC AM TUNER

Has 3 tuned RF circuits; built-in antenna; 10-kc filter; etc. 4 tubes plus rectifier and tuning eye. Size, 4 3/4 x 12 x 1 1/4". Less cage; takes AEG type listed at right. For operation from 110-120 volts, 50-60 cycle AC.

## SCOTT

### STEREO CONTROL



Size: 7x5 1/4 x 5 1/2" D.

Permits instantaneous conversion of monaural systems to stereo. Simultaneous control over two separate amplifiers from a central point.

MODEL 135. Less Cover. Net.... \$ 24.95  
MODEL "E" Metal Cover ..... 4.95  
MODEL "EW" Wood Cover..... 11.95

### 22-WATT HI-FI

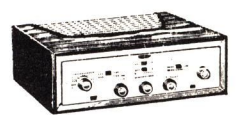

Complete, compact 22 watt amplifier including preamplifier controls and power amplifier, 44 watts peak.

MODEL 99D. Less Cover. Net.... \$109.95  
MODEL "C" Metal Cover..... 9.95  
MODEL "CW" Wood Cover. (Specify Mahog., Walnut or Blonde)..... 19.95

### 40-WATT STEREO



STEREO AMPLIFIER. 40 watt complete stereo amplifier with dual pre-amplifiers and dual 20 watt power sections.

MODEL 299. Less Cover. Net.... \$199.95  
MODEL "C" Metal Cover..... 9.95  
MODEL "CW" Wood Cover (Specify Mahog., Walnut or Blonde)..... 19.95

### AM-FM TUNER

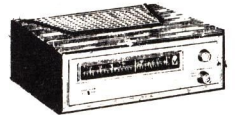

AM-FM TUNER. Matches all Scott amplifiers. FM wide-band circuitry features freedom from noise, drift and distortion.

MODEL 300. Less Cover. Net.... \$ 159.95  
MODEL "C" Metal Cover..... 9.95  
MODEL "CW" Wood Cover (Specify Mahog., Walnut or Blonde)..... 19.95

# DISCOUNTS WRITE FOR PRICES ON ANY COMBINATION OF HI-FI COMPONENTS



# SPEAKERS For Every Purpose

## Model CR-12X Coaxial 2 Way High Fidelity 12-inch Speaker



**SPECIAL!**  
\$ 27<sup>95</sup>

MODEL CR-12X has a self-contained electronic crossover network consisting of coil and condenser built into speaker housing.

CR-12X is a high quality 2-way speaker, consisting of 12-inches woofer, 2½ inches superior cone tweeter, matching in power and efficiency with electrical crossover. Thanks to its finest transient and directional characteristic efficiency, combined with its high frequency response of 30-16,000 cps, perfect sound reproduction is positively ensured for both home and other professional uses by connecting this speaker to the out-put terminal of the amplifier. This unit will handle a capacity of 25 watts, and sensitivity of 102 dB/W, lowest resonant frequency of 40±10 cps.

Electrical crossover of the network is 3,500 cps. Woofer's flux density is 10,700 gauss and tweeter's; 12,000 gauss. Total flux of this woofer is 157,000 maxwell. Diameter is 12 inches. Voice coil impedance is 8 or 16 ohms. Weight 12 lbs.

Clean and crisp response to the lowest frequencies and excellent damping are inherent in this speaker system. Ideal for the home hi-fi system and equally suited for commercial monitoring of recording or component testing. Designed to handle 25 watts of power this speaker will compare in performance with speakers costing much more.

## PMB-4 4-inch PM in Wood Cabinet Baffle

This beautifully finished 2-tone natural wood cabinet houses a full 4-inch speaker with heavy Ticonal 7 magnet. Sloping front baffle with back enclosed makes it ideal for wall mounting. This extension speaker and baffle unit is complete with wired jack and plug for quick connection. Extremely well suited for intercom and similar applications. 3.2 ohm voice coil.



\$ 2<sup>19</sup>

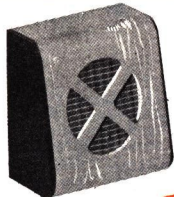

\$ 2<sup>95</sup>

## PMB-2.5 Miniature Speaker and Baffle

A 2½" PM Speaker mounted in a fully enclosed baffle—back cover closes solidly with 4 screws. Made of plastic, the baffle is Maroon in color and is designed to increase the usefulness of the speaker, to protect it, and to lend beauty to any application. Perfect for extension speaker use. The speaker is 2½" square and has a 3.2 ohm voice coil. Baffle size is only 3"x2½". Equipped with plug and jack

## CT-1 Tweeter



\$ 3<sup>79</sup>

CT-1 Tweeter 2⅞" diameter x 2" depth. True hi-fidelity reproduction of the upper audio range, at a very moderate price. This tweeter handles 10 watts of power and has a response range of 3,000 - 16,000 cps. Heavy screen protects speaker cone, and back is entirely en-

closed. Attractive Satin Gold finish. Comes equipped with rigid mounting bracket and connecting cord attached. Specify 8 or 16 ohm impedance, and use with crossover network CN-2 or similar. Weight 1 lb.

## 3-Way Extended Range Speaker

Cal-rad's famous line of High Fidelity speakers bring you concert hall music reproduction. Our speakers are of the finest high quality, high fidelity units produced. The two 3-way extended range speakers consist of a mechanical 2-way cone (both bass and mid-range frequency) having excellent cone structure and unique design using the drip-dry method of cone treatment. This permits the cone fibres to contract loosely allowing full passage of sound with excellent conversion features. The tweeter is the horn driver type with heavy duty magnet. Being contained in one unit, installation is simple, also producing real High Fidelity without feeling any change of sound source on the overall frequency range.

These speakers include an L/C network and brilliance control which permits perfect sound reproduction for both home and other professional uses—by adjusting the brilliance control to suit any acoustic condition of your own room or listener. Speakers are housed in heavy cast frames.

### SPECIFICATIONS

|                                     |                                     |
|-------------------------------------|-------------------------------------|
| Frequency Response: 25 - 16,000 cps | Woofer Flux Density: 10,700         |
| Resonant Frequency: 30 - 40 c/s     | Tweeter Density: 13,000             |
| Voice Coil Impedance: 16 ohms       | Woofer Total Flux: 300,000 maxwells |
| Maximum Power: 30 watts             | Tweeter Total Flux: 30,600 maxwells |
| Sensitivity: 105 db/w               | Diameter of Frame: 16.9 inches      |
| Mechanical Crossover: 500 cps       | Depth: 7.6 inches                   |
| Electrical Crossover: 3500 cps      | Weight: 18.5 lbs.                   |
| (6 db/oct)                          |                                     |

## Model 15TX1 3-way 15-inch Extended Range Loudspeaker System

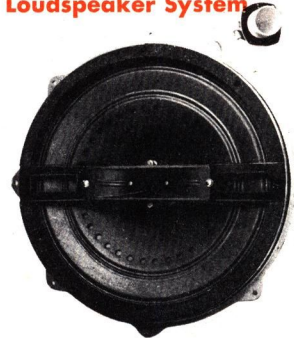

\$ 69<sup>95</sup>

## Model 12TX1 3-way 12-inch Extended Range Loudspeaker System



\$ 53<sup>95</sup>

### SPECIFICATIONS

|                                     |
|-------------------------------------|
| Frequency Response: 30 - 16,000 cps |
| Resonant Frequency: 35 - 45 cps     |
| Voice Coil Impedance: 16 ohms       |
| Maximum Power: 25 watts             |
| Sensitivity: 102 db/w               |
| Mechanical Crossover: 500 cps       |
| Electrical Crossover: 3,000 cps     |
| Woofer Flux Density: 10,300 gauss   |
| Tweeter Density: 13,000 gauss       |
| Woofer Total Flux: 157,000 maxwell  |
| Tweeter Total Flux: 30,000 maxwell  |
| Diameter of Frame: 14 inches        |
| Depth: 7½ inches                    |
| Weight: 13 lbs.                     |

## Model CR-8X Coaxial, 2-way High Fidelity 8-inch Loudspeaker

Woofer flux density is 10,000 gauss and that of the tweeter 10,000 gauss. Total flux of the woofer is 53,000 maxwell.

Diameter 8¾ inch, Depth 4½ inch, Baffle opening 7 inch, Voice coil impedance 8 or 16 ohm, Weight 3.5 lbs.

A superior 8-inch coaxial speaker unequalled in performance by more costly speakers. Excellent low range characteristics with an axial mounted 2½ inch heavy magnet cone tweeter. The woofer has a frequency response of 40-4,000 cps, and the cone tweeter covers from the electronic cross-over of 4,000 cps to 16,000 cps through the network. Excellent for use in hi-fi systems or commercial installations due to its moderate cost. This speaker has a sensitivity of 102 dB/W and will handle 10 watts with a frequency response of 40-16,000 cps and the lowest resonant frequency of 60±10 cps equalling many 12-inch speakers in its faithful performance.



\$ 14<sup>95</sup>

# COLUMBIA ELECTRONIC SALES MAIL ORDER DEPT.

WHOLESALE - RETAIL STORE  
2251 WEST WASHINGTON BLVD.  
LOS ANGELES 18, CALIFORNIA • RRepublic 1-2206  
OPEN MON. & FRI. TILL 9:00 P.M. - SAT. 9 TO 5:30

SAN FERNANDO VALLEY RETAIL STORE  
and WHOLESALE WAREHOUSE  
4900 LANKERSHIM BLVD.  
NORTH HOLLYWOOD, CALIFORNIA • Stanley 7-2113 - POplar 6-8668  
OPEN 9 TO 9 WEEKDAYS - SAT. 9 TO 6



QUALITY PRICE SERVICE ARE REASONS FOR OUR LARGE

# SPEAKER SALES



**R & A**

The makers of the famous R & A 700 Series Loudspeakers have had thousands of requests from fidelity enthusiasts for a *higher* fidelity Reproducer designed especially for the connoisseurs of good sound. — Here is the new series Mark III featuring co-axial construction ensuring permanent alignment — complete magnet assembly readily removable without de-magnetization — zero external field — extremely high sensitivity and wide response; smooth up to and above 14,500 cycles. Make your own listening test and hear the difference.



**3 NEW HIGH FIDELITY REPRODUCERS**

**700 SERIES MARK III**

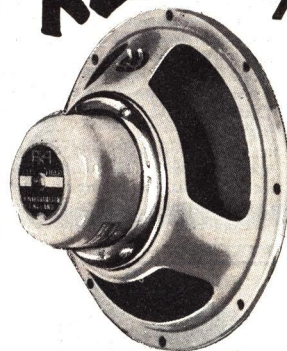

**7.95**

8"—10" and 12" Models— all with Alcomax III Anisotropic Magnet Systems of 12,000 Gauss Flux Densities.

| Type | Size | Voice Coil | Fundamental Resonance | Voice Coil Impedance | Magnet Strength | Handling Power Capacity |
|------|------|------------|-----------------------|----------------------|-----------------|-------------------------|
| 780  | 8"   | 1"         | 80 cycles             | 8 ohms               | 12000 Gauss     | 15 Watts                |
| 7100 | 10"  | 1"         | 65 cycles             | 8 ohms               | 12000 Gauss     | 20 Watts                |
| 7120 | 12"  | 1"         | 60 cycles             | 8 ohms               | 12000 Gauss     | 25 Watts                |

All Mountings to R. M. A. Standards

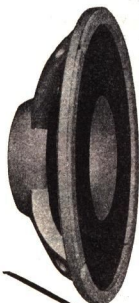

## Calrad MODEL CR-12A FULL RANGE HIGH FIDELITY

### 12 Inch Mechanical Two-way Loudspeaker

Description: **LATEST RELEASE**

This speaker embodies 2 reproducing cones mounted coaxially with power coming from the same voice coil. The CR-12A brings you the finest in concert hall music reproduction. With a power rating of 20 watts, this unique speaker performs beyond expectation while retaining its capacity to carry the above normal load requirements without distortion.

Specification:

This 12 inch loudspeaker has a frequency response of 30 to 13,000 cps, lowest resonance 50 ± 10 cps, capacity 20 watts, peak at 40 watts and a sensitivity of 102 dB/w. Impedance is 8 and 16 ohms with mechanical crossover at 1,800 cps. Total flux is 85,000 maxwell. Diameter 12-<sup>1</sup>/<sub>4</sub>", Depth 3-<sup>1</sup>/<sub>2</sub>", Baffle opening 11"; the CR-12A mounts with four <sup>1</sup>/<sub>4</sub>" holes equally spaced on a 11-<sup>1</sup>/<sub>2</sub>" circle. Weight is 6 lbs.

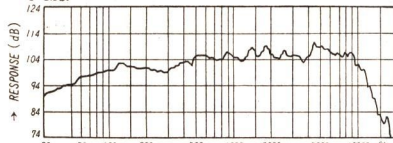

**\$ 15.95**

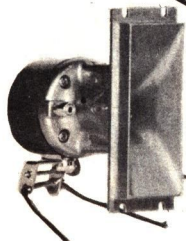

**CT-3 \$14.95**  
**Rectangular Horn Tweeter**

20 watts maximum power. This tweeter gives excellent tonal purity with smooth response from 1,700 to 16,000 cps. Sensitivity is 102 db/w. With a crossover frequency of 3,800 cps the CT3 provides clean and crisp tone quality from the mid-range frequencies through to the highs. Performs exceptionally well in either a 2-way or 3-way system. Cut-off frequency—1,500 cps. Voice coil is aluminum wire wound; impedance: 8 or 16 ohms. Flux density is 13,500 gauss, and total flux is 32,500 maxwell. 4<sup>3</sup>/<sub>4</sub>" x 2" horn, 4<sup>3</sup>/<sub>4</sub>" depth. Finished in stain gold and gray, chrome trim. Weight—3 lbs.

sitivity is 102 db/w. With a crossover frequency of 3,800 cps the CT3 provides clean and crisp tone quality from the mid-range frequencies through to the highs. Performs exceptionally well in either a 2-way or 3-way system. Cut-off frequency—1,500 cps. Voice coil is aluminum wire wound; impedance: 8 or 16 ohms. Flux density is 13,500 gauss, and total flux is 32,500 maxwell. 4<sup>3</sup>/<sub>4</sub>" x 2" horn, 4<sup>3</sup>/<sub>4</sub>" depth. Finished in stain gold and gray, chrome trim. Weight—3 lbs.

## REFLEX TRUMPET SPEAKER

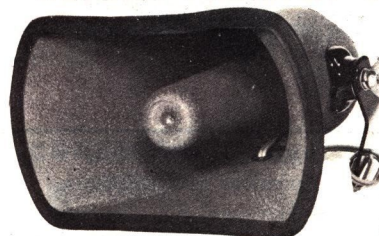

**\$17.95**

**SPECIFICATIONS**

Power Rating: 12 Watt  
Voice Coil Impedance: 8 ohm  
Frequency Range: 340 - 7,000 cps. Waterproofed.

Horn Opening: 5" x 8"  
Overall Length: 8 inches  
Net Weight: Approx. 3 lbs.

The Model DH12 Trumpet Horn Speaker is a combination type Trumpet Horn Speaker with the Driver Unit enclosed within the Horn. Complete Waterproofing and Rustproofing with Shockproof construction has made this speaker a rugged Trumpet Speaker for rough use. Its lightweight aluminum construction and small size give versatility in use.

The diaphragm constructed with a special resinification process has made it possible to withstand up to 50% power input overload.

Constructed for wide angle coverage with ability to produce crisp, sharp and effective music or speech in areas where high noise level might be encountered. Complete with swivel mounting bracket furnished in grey Hammertone finish, and connecting cord.

Cat. No. DH-12

## PS-10 "Whisper" Pillow Speaker

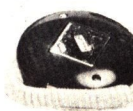

**\$1.95**

Inaudible except to the user. Low impedance type employing Bone Conduction principle; gives amazing tone fidelity in by-passing the ear, transmitting the sound to the "inner ear" by direct contact. Is not tiring to the user. Connects to voice coil side of output transformer. Supplied with complete instructions for connection and use.

# COLUMBIA ELECTRONIC SALES MAIL ORDER DEPT.

WHOLESALE - RETAIL STORE  
2251 WEST WASHINGTON BLVD.  
LOS ANGELES 18, CALIFORNIA • Republic 1-2206  
OPEN MON. & FRI. TILL 9:00 P.M. — SAT. 9 TO 5:30

SAN FERNANDO VALLEY RETAIL STORE  
and WHOLESALE WAREHOUSE  
4900 LANKERSHIM BLVD.  
NORTH HOLLYWOOD, CALIFORNIA • Stanley 7-2113 — POplar 6-8668  
OPEN 9 TO 9 WEEKDAYS — SAT. 9 TO 6



# T.V. ACCESSORIES · SPEAKERS · ANTENNAS

A Wall feed through for 300 ohm wire. Adjustable for any wall. Waterproofed. Complete with wall plate. 95¢ ea.

B. Trol-Aid for cleaning volume controls etc. Complete with wall hanger and long reach nozzle \$1.98 ea. smaller caddy size 98¢ ea.

C. Tune-O-Lube. Same as above except for cleaning tuners, switches etc. Large size complete. \$1.98 smaller caddy size 98¢

D. TV wall plate complete with matching plug. Ivory only. 75¢ ea.

E Strap around clamp for antenna masts. Adjustable. 15¢ ea

F. Indoor "rabbit ears" type TV antenna. Molded base, with three section whips. With wire. \$1.39 ea.

G. TV cheater cord. All molded. 39¢ ea.

H. Paralell picture tube booster. will fit most sets. 95¢ ea.

I. Antenna clip, two wire. Clips onto the antenna posts of most sets. Also for hi-fi speaker outputs. 25¢ ea.

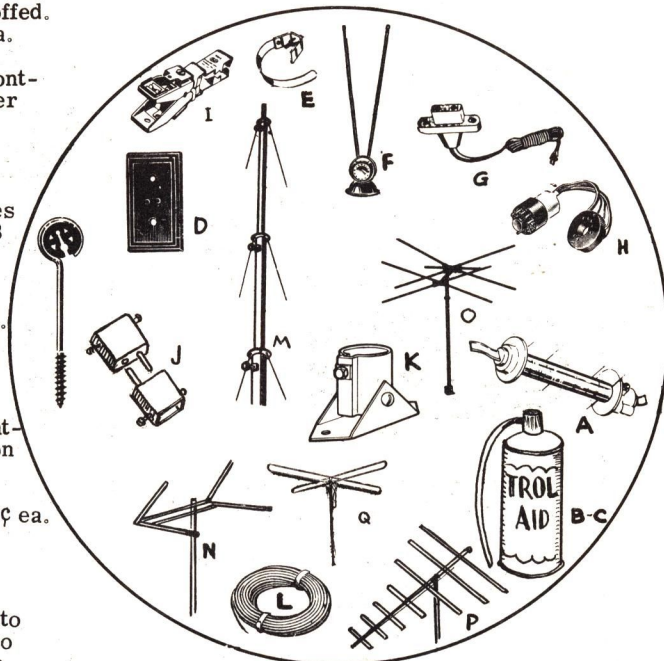

J. 300 ohm plug & jacks for joining two wires polarized 39¢ pair.

K. Heavy duty mounting base. Will handle most masts and any angle. All steel. 95¢ each.

L. 300 ohm lead in wire. Heavy duty finest quality. 50 ft. 95¢ 100 ft. 1.95

M. Telescoping masts, heavy duty steel construction. Shipped express. 20 ft. \$5.00 40 ft. \$9.95 30 ft. \$7.50 50 ft. \$12.50

N. Arrow antenna. All aluminum. less mast. \$1.95 ea. 5 foot mast for above. .95 ea.

O. Conical antenna. All aluminum. Less mast. \$2.95 Mast for above. .95

P. Seven element yagi. For Poor reception areas. \$9.95 10 foot steel mast for above. \$1.95

Q. All aluminum non-directional FM antenna. With mast & guy ring. \$4.95 ea.

R. Standoff insulator. 2 for 15¢

## BLOCKBUSTING VALUES ON Replacement Speakers



| OVAL   |        | ROUND                |        |
|--------|--------|----------------------|--------|
| 4 X 6  | \$1.89 | 6 X 9                | \$2.49 |
| 5 X 7  | 1.95   | 6X9 DELUXE w/WHIZZER | 2.89   |
| ROUND  |        |                      |        |
| 3 1/2" | \$1.25 | 8"                   | \$2.49 |
| 4      | 1.35   | 10                   | 3.95   |
| 5      | 1.49   | 12                   | 4.95   |
| 6      | 1.69   | 12 EXTRA HEAVY       | 7.95   |

**PRE-WIRED SWITCHES** for rear seat speaker  
Complete with wire and mounting plate. **69¢**

**DELUXE FADER CONTROL**  
Fades from front to rear speakers. **79¢**

## DELUXE COMPLETE REAR DECK AUTO SPEAKER KIT



Contains everything for installing a rear seat speaker in any car: a Rear Deck Grille, Switch Kit; Stock No. SW-54 and PM Auto speaker with Alnico 5 Magnet. All hardware, wire and instructions included.

with 6X9 SPEAKER \$3.50  
with 5X7 SPEAKER \$2.95

## REAR DECK SPEAKER GRILLE FOR ALL CARS



Handsome oval grille with perforated bezel to protect speaker cone. Hard baked grey hammerloid finish, harmonizes with any car interior.

6X9 WHITE 55¢ CHROME 6X9-99¢  
CHROME 5X7 89¢  
HAMMERTONE 5X7 79¢

## Remote Speaker WITH MANY USES!

With Volume Control

Sit in your easy chair and control volume of TV set or remote speaker. Connects to any TV set, Radio or Record Player. With 20 ft. of cable and instructions for easy connection.

**only \$3.95**

## MASTER MOBILE ANTENNAS



**MB-1** **MBS-1** **MB-2**

**SWIVEL BASE:** Has adjustable split-ball with positive locking feature.  
Model MB-1 ..... **\$2.89**

**SWIVEL BASE AND SPRING:** Spring is of oil-tempered heavy spring steel.  
Model MB-2—Standard ..... **\$4.16**  
Model MB-2H—Heavy Duty ..... **\$4.81**

**STAINLESS STEEL MASTS:** Exceptionally high tensile strength. Fit either MB-1 or MB-2 or any standard base.

Model MM-60 60" ..... **\$3.39**  
Model MM-72 72" ..... **\$3.39**  
Model MM-84 84" ..... **\$3.57**  
Model MM-96 96" ..... **\$3.99**

**BASE SPRINGS:** Flexible cable thru center of springs maintains constant electrical impedance.  
Model MBS-1—Standard ..... **\$1.45**  
Model MBS-2—Heavy Duty ..... **\$2.06**

# COLUMBIA ELECTRONIC SALES MAIL ORDER DEPT.

WHOLESALE - RETAIL STORE  
2251 WEST WASHINGTON BLVD.  
LOS ANGELES 18, CALIFORNIA • Republic 1-2206  
OPEN MON. & FRI. TILL 9:00 P.M. - SAT. 9 TO 5:30

SAN FERNANDO VALLEY RETAIL STORE  
and WHOLESALE WAREHOUSE  
4900 LANKERSHIM BLVD.  
NORTH HOLLYWOOD, CALIFORNIA • Stanley 7-2113 - POplar 6-8668  
OPEN 9 TO 9 WEEKDAYS - SAT. 9 TO 6



# KITS & PHONO ACCESSORIES



HFT90

## FM TUNER

**HFT90:** surpasses wired tuners up to 3X its cost. Pre-wired, pre-aligned, temperature-compensated "front end" — drift-free. Precision "eye-ronic" tuning. Sensitivity, 1.5 uv for 20 db quieting — 6X that of other kit tuners. Response 20-20,000 cps  $\pm 1$  db. K-follower & multiplex outputs. "Drift absolutely absent; audio quality excellent; novel tuning quite effective." — ELECTRONICS ILLUSTRATED. Kit \$39.95\*. Wired \$65.95\*. Cover \$3.95. \*Less cover, F.E.T. incl.



HF81

**HF81: Stereo Dual Amplifier-Preamp** selects, amplifies & controls any stereo source — tape, discs, broadcasts — & feeds it thru self-contained dual 14W amplifiers to a pair of speakers. Monophonically: 28 watts for your speakers; complete stereo preamp. Ganged level controls, separate focus (balance) control, independent full-range bass & treble controls for each channel. Identical Williamson-type, push-pull EL84 power amplifiers, excellent output transformers. "Low silhouette" construction. Kit \$69.95. Wired \$109.95. cover included.

**HF14: 14-Watt Power Amplifier**, of the HF81 above. Kit \$23.50. Wired \$41.50.



## STEREO AND MONAURAL KITS & WIRED



HF85

### STEREOPHONIC EQUIPMENT

**HF85: Stereo Dual Preamp** selects, preamplifies & controls any stereo source — tape, discs, broadcasts. Distortion borders on unmeasurable. Self-powered. Works with any 2 high-quality power amplifiers such as EICO HF14, HF22, HF30, HF35, HF50, HF60. Available shortly.



HF32

**HF32: 30-Watt Integrated Amplifier** combines excellent HF30 power amplifier above with versatile preamp featuring tape head & microphone inputs, scratch & rumble filters, all amplifier facilities. Kit \$57.95. Wired \$89.95. Both include cover.

**HF20: 20-Watt Integrated Amplifier** complete with finest preamp-control facilities, excellent output transformer that handles 34W peak power, plus a full Ultra-Linear Williamson power amplifier circuit. "Well-engineered" — Stocklin, RADIO TV NEWS. Kit \$49.95. Wired \$79.95. Matching Cover E-1 \$4.50.

**HF12: 12-Watt Integrated Amplifier** provides complete "front end" facilities & excellent performance for any medium-power application. "Packs a wallop" — POPULAR ELECTRONICS. Kit \$34.95. Wired \$57.95.

### MONAURAL INTEGRATED AMPLIFIERS (use 2 for STEREO)

**HF52: 50-Watt Integrated Amplifier** with complete "front end" facilities & Chicago Standard Output Transformer. Ultra-Linear power amplifier essentially identical to HF50. "Excellent value" — Hirsch-Houck Labs. Kit \$69.95. Wired \$109.95. Matching Cover E-1 \$4.50.

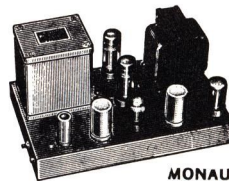

### MONAURAL POWER AMPLIFIERS (use 2 for STEREO)

**HF60: 60-Watt Ultra Linear Power Amplifier** with Acro TO-330 Output Transformer; wide band-width, virtually absolute stability & flawless transient response. "One of the best-performing amplifiers extant; an excellent buy." AUDIOCRAFT Kit Report. Kit \$72.95. Wired \$99.95. Matching Cover E-2 \$4.50.

**HF50: 50-Watt Ultra Linear Power Amplifier** with extremely high quality Chicago Standard Output Transformer. Identical in every other respect to HF60, same specifications at 50 watts. Kit \$57.95. Wired \$87.95. Matching Cover E-2 \$4.50.

**HF35: 35-Watt Ultra-Linear Power Amplifier** version of the HF60 above. Kit \$47.95. Wired \$72.45.

**HF30: 30-Watt Power Amplifier** employs 4-EL84 high power sensitivity output tubes in push-pull parallel, Williamson circuit, 20 db feedback, & high stability margin. 2-EZ81 full-wave rectifiers for highly reliable power supply. Unmatched value in medium-power amplifiers. Kit \$39.95. Wired \$62.95. Matching Cover E-3 \$3.95.

**HF22: 22-Watt Power Amplifier** version of the HF60 above. Kit \$38.95. Wired \$61.95.



### MONAURAL PREAMPLIFIERS (stack 2 for STEREO)

**HF65:** superb new design. Inputs for tape head, microphone, mag-phono cartridge & hi-level sources. IM distortion 0.04% @ 2V out. Attractive "low silhouette" design. HF65A Kit \$29.95, Wired \$44.95. HF65 (with power supply) Kit \$33.95. Wired \$49.95.

**HF61:** "Rivals the most expensive preamps" — Marshall, AUDIOCRAFT. HF61A Kit \$24.95, Wired \$37.95, HF61 (with power supply) Kit \$29.95. Wired \$44.95.

## DYNAKIT AMPLIFIER KITS



MARK III  
60 WATT  
AMPLIFIER KIT

\$ 79.95

MARK II 50 WATT  
AMPLIFIER KIT \$69.75

PRE-AMP. KIT \$34.95  
(WIRED 59.95)

MODEL PSI DUAL PRE-AMP  
POWER SUPPLY KIT 8.95

*Free with any UNIT PURCHASED ON THIS PAGE A PRECISION, BALANCE-TYPE STYLUS PRESSURE GAUGE.*



Model 371 STANTON 45X45 Stereo-FLUXVALVE Cartridge has two balanced signal outputs for connection to the low mag inputs of a stereo-preamp (they may be connected in parallel for use with a conventional single-channel preamp.) Output level is sufficient for all preamplifiers and there is no need to employ a transformer or other "gain" stage device. Exclusive "magnetic-discriminator" provides inter-channel isolation with negligible crosstalk.

Model 371—.7D STANTON 45X45 Stereo-FLUXVALVE Cartridge ..... \$29.85

PICKERING  
For those who  
can hear the  
difference

Model 196 STANTON 45X45 UNIPOISE arm with integrated Stereo-FLUXVALVE pickup.

This advanced mechanical design and functional styling combine to provide the finest phonograph reproducer ever made... for all microgroove records... monophonic and stereophonic! For use with all high quality transcription turntables, its practical size permits installation into areas only slightly larger than that required for record changers... it will mount on a motorboard measuring only 15 1/2" x 15 1/2". Simple Uni-mount installation, employs a single thumbscrew and bolt. Exclusive arm rest with soft sable brush to keep the stylus tip free of dust at all times. Convenient stylus force adjustment.

Model 196—.7D UNIPOISE Arm with Integrated Stereo-FLUXVALVE pickup... \$59.85

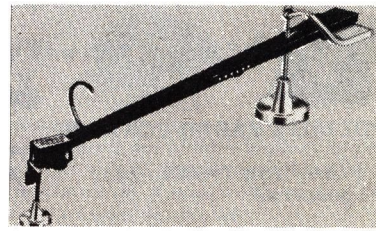

# COLUMBIA ELECTRONIC SALES MAIL ORDER DEPT.

WHOLESALE — RETAIL STORE  
2251 WEST WASHINGTON BLVD.  
LOS ANGELES 18, CALIFORNIA • REpublic 1-2206  
OPEN MON. & FRI. TILL 9:00 P.M. — SAT. 9 TO 5:30

SAN FERNANDO VALLEY RETAIL STORE  
and WHOLESALE WAREHOUSE  
4900 LANKERSHIM BLVD.  
NORTH HOLLYWOOD, CALIFORNIA • STAnley 7-2113 — P0plar 6-8668  
OPEN 9 TO 9 WEEKDAYS — SAT. 9 TO 6



# EICO LABORATORY PRECISION INSTRUMENTS & KITS

## MODEL 625 TUBE TESTER

Tests all conventional and TV tubes. Tests new 600 ma filament series string tubes. 10 individual lever-type element switches. 4 1/2" meter; 3-color scale; roll-chart. Line adjust control; protective overload bulb. Two grid caps; blank socket for future tubes; pilot light test socket.

**Model 625 Tube Tester—Wired, ready to use. Net. . . . \$49.95**  
**Model 625-K Tube Tester Kit—Net. Each. . . . \$34.95**  
**Model 625-C—Wired. In counter display case. Net. Each. . . . \$59.95**  
**Model 625-CK—Kit. In counter display case. Net. Each. . . . \$44.95**  
**Model CRA CRT Adapter—For testing CRT's. Net. . . . 4.50**

## MODEL 666 TUBE AND TRANSISTOR TESTER

Tests all transistors; reads both reverse collector current and current amplification factor (Beta), using internal power supply. Tests all receiving tubes, including 9-pin miniatures, subminiatures, color and monochrome CRT's. 10 six-position lever switches; 10 push-button switches. Large meter scale; roll chart; detachable steel cover.

**Model 666 Tube and Transistor Tester—Wired. Net. . . . \$109.95**  
**Model 666-K Tube and Transistor Tester Kit—Net. Ea. \$69.95**

## LOW-COST MULTI SIGNAL TRACER 145A

High gain RF and low gain audio input channels for signal tracing and trouble shooting RF, IF, and audio stages of AM, FM, and TV receivers. More than enough RF gain to trace up to receiver input; signal is heard through built-in 5" PM speaker. Shielded RF crystal demodulator and direct probes supplied. Noise localizer circuit applies DC test voltage through probe to suspected component and simultaneously picks up and amplifies effect. May be connected as test speaker, amplifier or output transformer. Output for VTVM or scope. For null detector, scope preamp, etc. Remarkably compact. With all parts. 7-13/16 x 5-9/16 x 5-1/16. Shipping weight, 7 lbs.

**KIT \$19.95**      **Factory Wired \$28.95**

## BATTERY ELIMINATOR

**ACCESSORY FILTER No. 1055 KIT \$11.95**

## "EXTRA-FILTERED" 6V and 12V

**BATTERY ELIMINATOR and CHARGER No. 1060 KIT \$38.95**

**SERIES/PARALLEL R-C Combination Box #1140 KIT \$13.95**

- Model 630-K CRT Checker Kit—Net. Each. . . . \$13.95**
- Model 944-K Flyback and Yoke Tester Kit—Net. Each. \$23.95**
- Model 1100-K Resistance Substitution Box Kit—Net. . . . \$5.95**
- Model 1171-K Resistance Decade Kit—Net. Each. . . . \$19.95**
- Model 1120-K Capacitance Substitution Box Kit—Net. . . . \$5.95**
- Model 1180-K Capacitance Decade Kit—Net. Each. . . . \$14.95**
- Model 488-K Electronic Switch Kit—Net. Each. . . . \$23.95**
- Model 950B-K Bridge-Comparator Kit—Net. Each. . . . \$19.95**
- Model 495-K Oscilloscope Calibrator Kit—Net. Each. . . . \$12.95**
- Model 460-K 5" Oscilloscope Kit—Net. Each. . . . \$79.95**
- Model 470-K 7" Oscilloscope Kit—Net. Each. . . . \$79.95**
- Model 540-K Utility Tester Kit—Net. Each. . . . \$12.95**

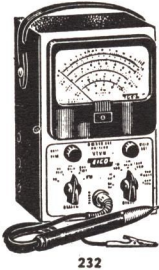
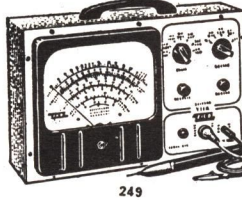
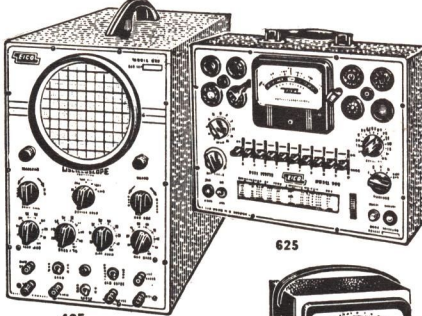
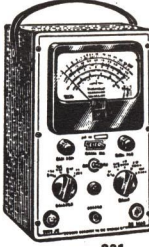
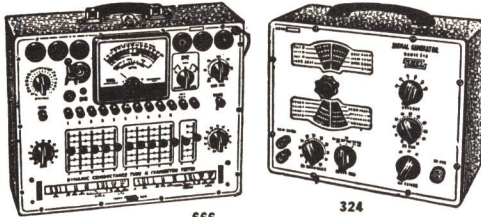

- Model 1050-K Battery Charger and Eliminator Kit—Net. Each. . . . \$29.95**
- Model 584-K Battery Tester Kit—Net. Each. . . . \$9.95**
- Model 555-K Multimeter Kit—1% resistors. Net. . . . \$29.95**
- Model 565-K Multimeter Kit—Net. Each. . . . \$24.95**
- Model 526-K Multimeter Kit—With 1% resistors. Net. 13.90**
- Model 556-K Multimeter Kit—1% resistors. Net. Each. 16.90**
- Model 536-K Multimeter Kit—Net. Each. . . . \$12.90**
- Model 566-K Multimeter Kit—Net. Each. . . . \$14.90**
- Model 147-K Multi-Signal Tracer Kit—Net. Each. . . . \$24.95**
- Model 214-K VTVM Kit—Net. Each. . . . \$34.95**

**MODEL HVP-2 HIGH VOLTAGE PROBE**  
 For safe measurement up to 30,000 VDC with any VTVM or 20,000 ohms/volt VOM. Includes choice of high quality multiplier resistor to match most popular instruments.  
**Model HVP-2 High Voltage Probe—Wired. Net. Each. . . . \$4.95**  
**Model HVP-1 High Voltage Probe—Similar uses as HVP-2; supplied with matching resistor for your instrument. Net. . . . \$6.95**

**MODEL 221 VTVM**  
 Large 4 1/2" meter with "can't-burn-out" circuit. Zero center for TV/FM discriminator alignment. **AC/DC Volts:** 0-5, 10, 100, 500, 1,000 (up to 50,000 v. with HVP probe up to 200 mc with PRF probe, and peak-to-peak with PTP probe). **Ohms:** 0.2 ohm to 1,000 megs. **DB:** -20 to +55. **Input R:** 25 megs. 1% precision multipliers. Double-triode bridge circuit. Three-color etched panel; steel case.  
**Model 221 VTVM—Wired, ready to use. Net. Each. . . . \$39.95**  
**Model 221-K VTVM Kit—Net. Each. . . . \$25.95**  
**Leatherette Carrying Case—For Model 221. Net. Each. . . . 3.95**

**MODEL 232 PEAK-TO-PEAK VTVM**  
 Similar in functions to the Model 249, but with 4 1/2" meter. With dual-purpose AC/DC Uni-Probe.  
**Model 232 VTVM—Wired, ready to use. Net. Each. . . . \$49.95**  
**Model 232-K VTVM Kit—Net. Each. . . . \$29.95**

**MODEL 324 RF SIGNAL GENERATOR**  
 IF-RF alignment, signal tracing and trouble-shooting of TV, FM, and AM sets on all fundamentals; marker generator. 400 cps sine wave audio testing. Also for lab and experimental work. **Extended Frequency Range:** Six fundamental bands: 150-400 kc, 400-1,200 kc, 1.2-3.5 mc, 3.5-11 mc, 11-37 mc, 37-145 mc; harmonic band 111 mc-435 mc. ±1.5% frequency accuracy. Colpitts RF oscillator, directly plate-modulated by cathode follower. Variable depth of probe tip modulation, 0-50% by 400 cps Colpitts oscillator. Variable gain external modulation amplifier; 3 v. needed for 30% modulation. Fine and coarse (3-step) RF attenuators; 50-ohm output impedance.  
**Model 324 RF Signal Generator—Wired. Net. Each. . . . \$39.95**  
**Model 324-K RF Signal Generator Kit—Net. Each. . . . \$26.95**

**MODEL 249 DELUXE PEAK-TO-PEAK VTVM**  
 Measures directly p-p voltage of complex and sine waves: 0.4, 14, 42, 140, 420, 1400, 4200. **DC/RMS sine volts:** 0-1.5, 5, 15, 50, 150, 500, 1,500 (up to 30,000 v. with HVP probe, and 250 mc with PRF probe). **Ohms:** 0.2 ohms to 1,000 megs. Seven non-skip ranges on every function. Calibration without removing from cabinet. 7 1/2" meter with "can't-burn-out" circuit. 1% multipliers. Zero center. With AC/DC Uni-Probe: One probe for all functions—half-turn of probe tip selects DC or AC ohms.  
**Model 249 VTVM—Wired, ready to use. Net. Each. . . . \$59.95**  
**Model 249-K VTVM Kit—Net. Each. . . . \$39.95**

**MODEL 425 5" PUSH-PULL OSCILLOSCOPE**  
 Push-pull amplifiers. **Sensitivity:** 0.05-0.1 rms v./in. **Response:** 5 cps-500 kc; useful to 2.5 mc. **Sweep:** 15 cps-75 kc. Z-axis intensity modulated. Direct connections to CRT plates. 5" CRT.  
**Model 425 5" Oscilloscope—Wired, ready to use. . . . \$79.95**  
**Net. Each. . . . \$49.95**  
**Model 425-K 5" Oscilloscope Kit—Net. Each. . . . \$49.95**

- Model 360-K TV/FM Sweep Generator Kit—Net. Each. \$34.95**
- 5 Mc or 4.5 Mc Crystals—Specify. Net. Each. . . . 3.95**
- Model 315-K Deluxe RF Signal Generator Kit—Net. . . . \$39.95**
- Model 352-K Bar Generator Kit—Net. Each. . . . \$14.95**
- Model 368-K Sweep-Marker Generator Kit—Net. Ea. \$69.95**
- Model 322-K Signal Generator Kit—Net. Each. . . . \$23.95**
- Model 320-K RF Signal Generator Kit—Net. Each. . . . \$19.95**
- Model 377-K Audio Generator Kit—Net. Each. . . . \$31.95**

- MODEL PLC OSCILLOSCOPE LOW CAPACITY PROBE Kit—Net. Each. . . . \$3.75**
- MODEL PSD OSCILLOSCOPE DEMODULATOR PROBE Kit—Net. Each. . . . \$3.75**
- MODEL PD OSCILLOSCOPE DIRECT PROBE Kit—Net. Each. . . . \$2.75**
- MODEL PTP-11 PEAK-TO-PEAK VTVM PROBE Kit—For 11 meg VTVM. Net. Each. . . . \$4.95**  
**Kit—For 25 meg VTVM. Net. Each. . . . 4.85**
- MODEL PRF-11 RF VTVM PROBE Kit—For 11 meg VTVM. Net. Each. . . . \$3.75**  
**Kit—For 25 meg VTVM. Net. Each. . . . 3.75**

# FREE!

With any instrument kit above, 10 sets of insulated, color coded allegator test leads.

## TEST-O-MATIC SPEEDS UP RADIO & T.V. SERVICE TESTS.



- ALL TUBE FIL.
- CIRCUIT CONTINUITY
- PICTURE TUBE FIL.
- FUSE & PILOT LAMP
- HIGH VOLTAGE

**\$6.95**

## OTHER MEASURING DEVICES

### CAPACITOR CHECKER

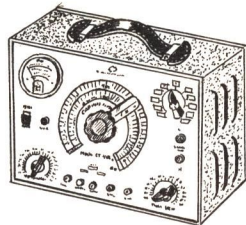

**\$9.95**

This complete capacitance analyzer originally sold for many times Columbia's low low LOW price. Used to check capacitors for leakage, shorts and value. Built-in meter measures leakage up to 100 megohms, also voltage and current. Has variable voltage and power factor controls. Will make qualitative tests or simple checks of almost any capacitor. Operates from 110 VAC 60 cy. Oxford-Tartak Model CT-400

Excellent cond.

### HOT METER BUY!

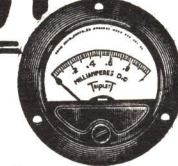

**2 1/2 INCH**  
**0 - 200 MA DC.**  
 WESTON or SANGAMO  
**NEW \$1.95**

# COLUMBIA ELECTRONIC SALES MAIL ORDER DEPT.

WHOLESALE - RETAIL STORE  
 2251 WEST WASHINGTON BLVD.  
 LOS ANGELES 18, CALIFORNIA • Republic 1-2206  
 OPEN MON. & FRI. TILL 9:00 P.M. - SAT. 9 TO 5:30

SAN FERNANDO VALLEY RETAIL STORE  
 and WHOLESALE WAREHOUSE  
 4900 LANKERSHIM BLVD.  
 NORTH HOLLYWOOD, CALIFORNIA • Stanley 7-2113 - POplar 6-8668  
 OPEN 9 TO 9 WEEKDAYS - SAT. 9 TO 6



# PHONO ACCESSORIES



## PA-1 Calrad Semi-Auto Phono Pickup

A manual pickup with completely automatic return of arm when record is finished. Soft rubber wheel carries

pickup arm back to arm rest. Cannot harm record; needle rides safely above the record and arm actuates switch in arm rest to shut off the turntable. Turntable starts again, automatically, when pickup arm is raised from rest. Dual styli turnover crystal cartridge with replaceable sapphire needles for playing LP's and 78's. On 9" or larger table arm works automatically with all record sizes up to 12". Complete with all mounting hardware, shut-off switch, instructions and mounting diagram. Individually boxed.

Cat. No. PA-1

**\$ 4.95**

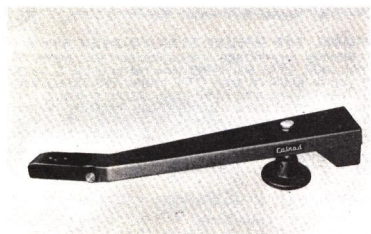

## Calrad Stereo Pickup Arm

### SPECIFICATIONS:

Overall Length: 11-13/16"  
Length between Stylus and Center of Pivot: 8 7/8"  
Cartridge Mounting Hole: 1/2" Std. Mtg. Centers.  
Balanced Weight: 4 weights supplied  
Lead Wires from Arm: 5  
Tracking Error: Within ±2 degree  
Non-Resonance Range: 20 - 20,000 c.p.s.  
Plug-in Type Head: 2 included

**7.95**

Modern design pickup arm for the latest types of stereo cartridges now on the market. This arm is supplied with all necessary hardware and 4 balancing weights to obtain the proper styles pressure needed. Well engineered to meet the necessary high standards required by the stereo user. Perfect performance when used with SC-415 Calrad Stereo cartridge. This stereo tone arm can also be used with regular records, and is balanced against rolling.

Cat. No. CS-12

## PROFESSIONAL VISCOUS DAMPED TONE ARMS — FLOATING ACTION

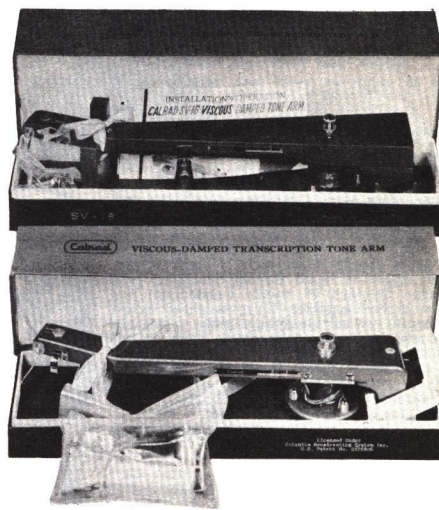

### Transcription Tone Arms

Advanced design high-quality transcription tone arms with viscous damping of both horizontal and vertical movements. Damping action is readily controlled by convenient adjustment knob on top of arm. Plug in head accepts all popular cartridges, and weights are supplied to compensate for different cartridges. Height of tone arm is adjustable by telescoping shaft. Tone arm base has adjustment screws for self leveling. Adjustable arm rest furnished. Gray Hammertone finish. Professional quality instruments, in two sizes. Licensed by C.B.S.

Cat. No. SV-12 For Records up to 12"

**\$ 12.95**

Cat. No. SV16 For Records up to 16"

**\$ 19.95**



## T-25 Compromise Pickup Arm

Has C-10 compromise crystal 3 Volt universal cartridge (less needle) for playing both standard and microgroove records. 4 speed light weight brown bakelite finish, arm is spring counterbalanced. Individually packaged. Single hole arm mounting. Plays records up to 12".

**3 FOR 7.95 \$ 2.95**

## SC-415 4 Lead Stereo Cartridge

Cal-rad presents its newest 4 Lead Compatible Stereo Cartridge offering performance of full-dimension sound with exceptional fidelity of both stereo and LP discs. This superior cartridge features high vertical and lateral compliance for the 45-45 stereophonic records. Complete with Jewel needle.

### SPECIFICATIONS

Mounting: Standard 1/2 inch center  
Dimensions: 1/2 inch high x 23/32 inch wide x 1-9/16 inch long  
Response: 20 - 15,000 cycles with gradual rolloff  
Output Voltage: 0.25 volts  
Channel Isolation: 20 db  
Tracking Pressure: 5 - 7 grams  
Stylus: Jewel tip 0.7 mil



**\$ 5.95**  
**3 FOR \$ 15.00**

## Calrad SC-515 Stereo-Turnover Cartridge



A truly magnificent product, produced to exacting specifications with 0.7 mil and 3 mil sapphire stylii, offering 20 db channel isolation; response 20 - 16,000 cps. Plays all 4 speeds for both stereo and monaural records. Excellent all-directional compliance.

### SPECIFICATIONS

Response: 20 - 16,000 cps with smooth roll-off beyond  
Output Voltage: 0.3 volt  
Tracking Pressure: 5 - 7 grams  
Channel Isolation: 20 decibals  
Mounting Dimensions: 1/2 in. std.  
Compliance: 2.0 x 10<sup>9</sup> cm/dyne

**3 FOR \$ 15.95**

**5.95**



## SN-215 Needle 45-45

Replacement stereo needle. Jewel sapphire tip for SC 315 — SC 415 — SC 515.

**\$ 1.49**

**3 FOR \$ 3.29**

## C-10 Crystal Compromise Cartridge



Will replace most cartridges in use. Plays all 4 speeds with 2 mil needle. Light weight, track as little as 3/4 oz. pressure. 1/2" standard mounting centers, thumbscrew and solder lugs. 3 V output.

**3 FOR \$ 2.99**

**1.19**

## CX-310 45 RPM Replacement Cartridge



Exact physical and electronic replacement for RCA type players. Frequency response: 50 - 10,000 cps, 1.0 Volt output. Complete with 1 mil sapphire stylus.

**3 FOR \$ 5.50**

**\$ 1.95**

# COLUMBIA ELECTRONIC SALES MAIL ORDER DEPT.

WHOLESALE — RETAIL STORE  
2251 WEST WASHINGTON BLVD.  
LOS ANGELES 18, CALIFORNIA • Republic 1-2206  
OPEN MON. & FRI. TILL 9:00 P.M. — SAT. 9 TO 5:30

SAN FERNANDO VALLEY RETAIL STORE  
and WHOLESALE WAREHOUSE  
4900 LANKERSHIM BLVD.  
NORTH HOLLYWOOD, CALIFORNIA • Stanley 7-2113 — POplar 6-8668  
OPEN 9 TO 9 WEEKDAYS — SAT. 9 TO 6



# HI-FI ACCESSORIES AT ROCK BOTTOM PRICES!

## L-Pads (Level Controls)

A flat frequency response and natural reproduction are obtained by adjusting for the difference in efficiency ratios. Adjustment  $\pm 17\%$  of the normal rated impedance. "L" pads are 8 or 16 ohms impedance. Black plastic contour knob. Calibrated 1 to 10. Dial  $2\frac{1}{2}'' \times 2''$ , finished in matte silver and black. Mounts in  $\frac{3}{8}''$  hole. Bushing  $\frac{3}{4}''$  long. Individually boxed.



Cat. No. LP-8 8 ohms LP-16 16 ohms  
**\$ 1.95**

## MULTIPLE SPEAKER SWITCH for Constant Impedance Circuits

A constant impedance multiple speaker selector switch selects, from one to six speakers, keeping impedance constant with proper 2 watt resistors in circuit. Uses six SPST slide switches, mounted on brass plate. With instructions. Individually packaged.  $3\frac{1}{2}''$  long,  $2\frac{3}{8}''$  wide, 1" deep.



Cat. No. CSS-1  
**\$ 2.39**

## 3-SPEAKER, 7-WAY WALL PLATE SELECTOR SWITCH

Speaker selector switch mounted on brass wall plate, fits standard single wall boxes. Selects speakers; 1 or 2 or 3, or 1 and 2, or 1 and 3, or 2 and 3, or all. Marked screw terminals. Instructions included. Individually packaged.  $4\frac{1}{2}'' \times 2\frac{3}{4}'' \times 2\frac{1}{4}''$  deep



Cat. No. CSS-2  
**\$ 2.79**  
**3 FOR \$6.50**

## HI-FI PHONO CABLE CONNECTORS



Male RCA type phono plug, one end, and Std. Slim 2-way phone plug on other.

Cat. No. IC-72 72" length  
**89c**



Male RCA type plug, one end, and Std. 2-way Barrel jack on other.

Cat. No. EX-72 72" length  
**99c**

## Jumper Cables



Male RCA type pin plug both ends.

| Cat. No. | Length    | Price | Cat. No. | Length     | Price |
|----------|-----------|-------|----------|------------|-------|
| JC-36    | 36 inches | 69c   | JC-72    | 120 inches | 89c   |
| JC-48    | 48 inches | 74c   | JC-120   | 120 inches | 99c   |
| JC-60    | 60 inches | 79c   |          |            |       |

## ACA Music Master

For use with all American type record players. Will automatically shut off all of the hi-fi system as soon as the last record has been played on any automatic turn table. No attention need be paid to your hi-fi system once this unit has been installed. Installation is simple as every item of your system plugs into the ACA.



## ACF Music Master

For use with all Foreign type record changers. Will automatically shut off all of the hi-fi system as soon as the last record has been played on any automatic turn table. No attention need be paid to your hi-fi system once this unit has been installed. Installation is simple as every item of your system plugs into the ACF.

**\$ 5.95**

## Audio Mixers

Permits balancing of any two individual—audio inputs into one output enabling user to mix 2 microphone inputs into high gain input. Separate balanced gain controls. (2) included.



Cat. No. AM-3  
 Has standard RCA type pin plug output from two RCA type input jacks. No wiring or cables needed. Size:  $2\frac{3}{8}''$  long x  $1\frac{3}{16}''$  wide x  $1\frac{1}{16}''$  high.  
**\$ 2.95**

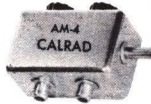

Cat. No. AM-4  
 Has standard phone plug output from two single RCA type input jacks. No wiring or cables needed. Size:  $2\frac{3}{8}''$  long x  $1\frac{3}{16}''$  wide x  $1\frac{1}{16}''$  high.  
**\$ 3.39**



Cat. No. AM-5  
 Has standard phone plug output from two closed circuit input jacks. No wiring or cables needed. Size:  $2\frac{3}{8}''$  long x  $1\frac{3}{16}''$  wide x  $1\frac{1}{16}''$  high.  
**\$ 3.39**

## WL 8

Speaker control mounted on brass wall plate will fit any standard outlet box. Has 8 ohm L pad. Closed circuit jack mounted below L pad.

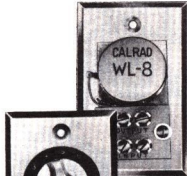

Cat. No. WL-8

## WL 16

Speaker control mounted on brass wall plate will fit any standard outlet box. Has 16 ohm L pad. Closed circuit jack mounted below L pad.



Cat. No. WL-16



## Stereo "L" Pad

A dual stereo "L" pad with single knob control for maintaining proper output level enabling the balancing of two speakers from the amplifier providing positive equal audio power to each speaker. Has  $\frac{7}{8}''$  inch threaded bushing.

Cat. No. SLP-8, 8 ohm  
 SLP-16, 16 ohm  
**\$ 3.95**



## PN-8A Sapphire All-Groove Needle

Offset shank compromise needle for all speeds. Use with pick-up having thumbscrew. Diameter of .002" for 16, 33, 45 and 78 rpm use.

REG. \$1.50  
**49c**



## C-64-MGS Calrad Phono Needle

Microgroove replacement stylus for Ronette type 33-45 cartridges. Sapphire 1 mil stylus.

**1.49**



## NC-1 Needle Checker

Optical instrument for critical examination of stylus tips, record grooves, etc. Approx. 50 power magnification shows any flaws or signs of wear. Front lens threaded for fine focus. Black with nickel trim.  $3\frac{3}{4}''$  long,  $\frac{1}{2}''$  diameter.

**\$ 1.39**

## PG-22 Stylus Pressure Gauge

Measures stylus pressure accurately at the turntable—from 0 to 30 grams. Aluminum alloy with steel pivots. Indicates any excess or insufficient tracking weight, resulting in wear or damage to the record.



**99c**



## Camel Hair Record Brush

RB-1

Cleans record groove ahead of the needle. Reduces noise; protects the record. Clips to most pickup arms, entirely automatic in operation.

**39c**

# COLUMBIA ELECTRONIC SALES MAIL ORDER DEPT.

WHOLESALE - RETAIL STORE  
 2251 WEST WASHINGTON BLVD.

LOS ANGELES 18, CALIFORNIA • Republic 1-2206  
 OPEN MON. & FRI. TILL 9:00 P.M. - SAT. 9 TO 5:30

SAN FERNANDO VALLEY RETAIL STORE  
 and WHOLESALE WAREHOUSE

4900 LANKERSHIM BLVD.  
 NORTH HOLLYWOOD, CALIFORNIA • Stanley 7-2113 - POplar 6-8668  
 OPEN 9 TO 9 WEEKDAYS - SAT. 9 TO 6



**COLUMBIA PRICE SMASHERS \* CHANGERS NEEDLES CARTRIDGE TAPE**



**DIAMOND NEEDLES**

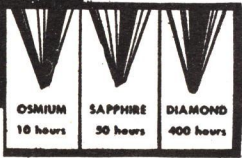

We can't mention the name of the manufacturer, but you will recognize it as one of the oldest and finest names in the business. Only Columbia's huge buying power can make prices such as these possible.

Each stylus is painstakingly ground to the most exact tolerances possible, then subjected to rigorous inspection. Individually packaged in clear plastic box on foam cushion. Fully guaranteed.

**TRULLY THE FINEST.**

- Single Diamonds. \$ 4.39
- Diamond Sapphire Combinations. \$ 5.95
- Dual Diamonds \$ 8.95
- Sound-Flo and Power Point Diamond Saph. \$ 9.95 \*

Be sure to give cartridge no. or better yet enclose old stylus. We will return it with your order.

**ALL TYPES ARE IN STOCK**

\* a few styles are slightly higher

\$23.37



**New! Stereo Classic STEREO CARTRIDGES**

Response 20-17,000 cps. Tracking force 3.5 to 7 grams. Dual mu-metal shield. Up to 25db separation between channels. Plays stereo or standard microgroove records. GC-7 diamond

**FREE!!!**

With the G.E. GC-7 or the Weathers C 501 D you will receive both a precision balance type stylus pressure gauge AND a precision stylus inspection microscope.

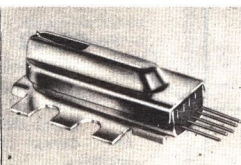

**features**

- Completely Compatible — Plays stereo and monaural records.
- 25 db Separation between channels — A new high in ceramics.
- 2 gram tracking force — Extremely low for ANY type of cartridge.
- Frequency Response — Flat response 15-30,000 cps.
- Output — 0.25 Volts 7 cm/sec.
- Completely shielded against hum.
- Replaceable jewel 0.7 mil radius sapphire or diamond stylus.
- Fits all standard mountings.
- Audiophile Net — C-501-D (Diamond) \$17.50
- C-501-S (Sapphire) 9.75

**Fabulous NEW MONARCH STEREO CHANGER**

**\$24.95**

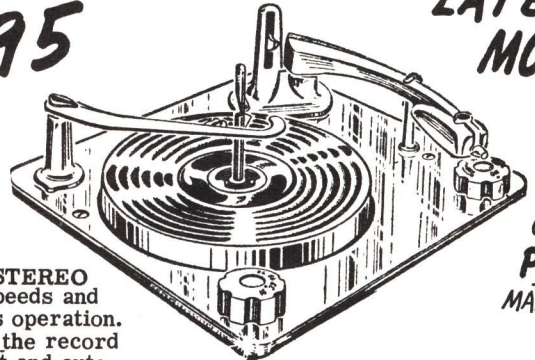

**LATEST MODEL**

MADE BY ONE OF ENGLAND'S PROUDEST MANUFACTURERS

The fabulous new Monarch STEREO record changer. Has four speeds and four pole motor for noiseless operation. The monarch gently lowers the record to the rubber protective mat and automatically selects the proper size. A heavy weighted turntable assures freedom from rumble, wow and flutter. Your Monarch will be shipped complete with instructions, hardware, 45 rpm spindle and dual sapphire turnover stereo cartridge. Check Columbia's price against any in the country.

- \* FOUR POLE MOTOR
- \* AUTOMATIC INTERMIX
- \* FOUR SPEED OPERATION
- \* CAST ALUMINUM TONE ARM
- \* LATEST TYPE STEREO CARTRIDGE
- \* RIBBED RUBBER TURNTABLE MAT
- \* PLAYS MONOURAL TOO!

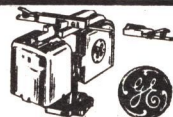

**VR-II Triple Play Magnetic Cartridge \$14.95**

Latest model of the world famous G. E. Variable Reluctance cartridge. New "Slim Look" design and mu-metal shielding. Special anti-hum coils allow this cartridge to be used confidently with any changer or tone arm. Unaffected by heat or humidity. Independently replaceable clip in tip stylii allow needles to be changed in seconds. Frequency response 20-20,000 cps. Tracking pressure 4-6gm. With 3 mil sapphire & 1 mil diamond.

**A FANTASTIC BONUS BUY !!!**

**the stereoRamic cartridge**

Another Weathers original . . . . The Weathers StereoRamic Cartridge is an entirely new development in ceramics, designed for use in changers and other tonearms.

This cartridge successfully combines low cost and high quality sound reproduction. It is the first ceramic cartridge which outperforms even the finest magnetic pickup and is second in quality only to the famous Weathers FM Stereo Cartridge.

**LOWEST PRICES ON RECORDING TAPE**

*Fully guaranteed!*

- 1200 feet acetate, 7" reel \$1.39
- 1800 feet mylar, 7" reel \$2.95



**IRISH RECORDING TAPE**

- Brown Band 1200 feet \$1.97
- Brown Band 600 feet \$1.70
- Green Band 1200 feet \$2.39

Irish Double Play  
2400 feet on 7 in reel \$5.85  
2400 feet on 7 in reel fortified, extra tensile strength \$7.95

- Empty Reels
- 7 inch empty reel 65¢
- 3 inch empty reel 49¢

**COLUMBIA ELECTRONIC SALES MAIL ORDER DEPT.**

WHOLESALE — RETAIL STORE  
2251 WEST WASHINGTON BLVD.

LOS ANGELES 18, CALIFORNIA • Rpublic 1-2206

OPEN MON. & FRI. TILL 9:00 P.M. — SAT. 9 TO 5:30

SAN FERNANDO VALLEY RETAIL STORE  
and WHOLESALE WAREHOUSE

4900 LANKERSHIM BLVD.

NORTH HOLLYWOOD, CALIFORNIA • Stanley 7-2113 — POplar 6-8668

OPEN 9 TO 9 WEEKDAYS — SAT. 9 TO 6



# LATEST RELEASE at Columbia's usual Prices

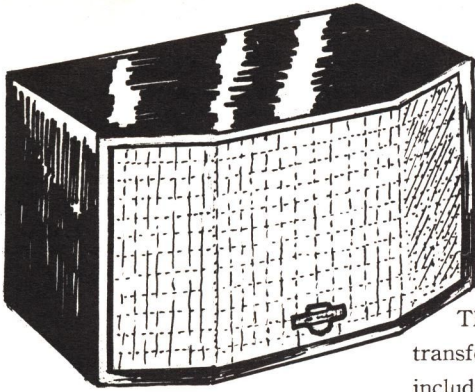

**CALRAD  
MODEL EL-3 \$24.95**

**ELECTROSTATIC 3 ELEMENT  
CONDENSER TWEETER**

This Electrostatic Tweeter is supplied with a crossover network and matching built-in transformer to connect either to an 8 or 16 ohm impedance output. The power supply is included within the Electrostatic Tweeter to operate from a 117 Volt 60 cycle AC power supply. Response is from 3,300 cps. to beyond 20,000 cps. with excellent transient response. For wide dispersion three electrostatic condenser tweeters are acoustically placed within the cabinet.

## GRILLE CLOTH



For that Hi-Fi speaker cabinet. Beautifully made by Mellotone. 36 in wide.

Metallic \$1.50 per foot  
\$3.99 per yard

Black with gold  
Black with silver  
Brown with gold  
Tan with Gold



Non-metallic  
\$1.25 per foot  
\$3.50 per yard  
Tan or  
dark brown

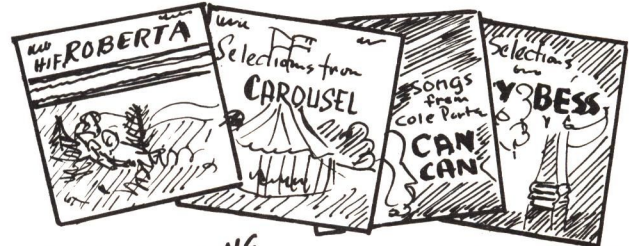

**12 INCH LONG PLAYING ALBUMS 98c ea.**

CHOOSE FROM THESE POPULAR TITLES

- |                     |                          |
|---------------------|--------------------------|
| Student Prince      | Old Time Piano           |
| Pal Joey            | Crimson Moods            |
| Can Can             | Polka Party              |
| Desert Song         | Sacred Organ Music       |
| My Fair Lady        | Latsst Popular Hits.     |
| King & I            | Childrens Songs          |
| Show Boat           | Waltz Time               |
| Carousel            | Holiday in Hawaii        |
| South Pacific       | Holiday in Hi-Fi         |
| Roberta             | Show Hits                |
| Porgy & Bess        | Holiday in Mexico        |
| Oklahoma            | Vivian Martin Spirituals |
| The Merry Widow     | Famous Ballets           |
| Operetta Highlights | Beetovan Eroica          |

Be sure to give second choices

## WILCOX-GAY

Recordio

MODEL FX300

TAPE RECORDER



**\$109.95**

1. An excellent 2-speed (7.5 and 3.75 ips) recorder and reproducer. The 7.5 ips speed is used for high fidelity recording and reproduction. With the two permanent dynamic speakers at the sides, you can enjoy thrilling audio reproduction that only the finest equipment could give. The 3.75 ips speed is used for speech and "dictation" recording and reproduction.
2. An extremely functional dictating and business machine. During recording and reproduction, tape motion can be easily stopped and/or played back instantly by means of a Remote Switch, enabling the operator to use the tape supply to its maximum advantage, without wasting valuable footage.
3. Your FX-300 comes equipped with an Earphone, enabling you to monitor the quality of sound during recording. During reproduction, you can use it conveniently to hear the recorded sound without disturbing others.

4. It also comes equipped with a tiny, but efficient crystal microphone of high sensitivity, permitting quality sound recording. The microphone is fitted with a special metal supporter, enabling you to place it either on the table, or on to your coat lapel by means of a clip.
5. For greater home enjoyment, your FX-300 comes with a set of Patch Cord, making it possible for anyone to record hi-fidelity music directly from the phonograph, radio or television receiver.

**RECORD  
CLEANING  
CLOTH** ANTI-STATIC  
PACKAGED **50c**

## COLUMBIA ELECTRONIC SALES MAIL ORDER DEPT.

WHOLESALE - RETAIL STORE  
2251 WEST WASHINGTON BLVD.  
LOS ANGELES 18, CALIFORNIA • Republic 1-2206  
OPEN MON. & FRI. TILL 9:00 P.M. - SAT. 9 TO 5:30

SAN FERNANDO VALLEY RETAIL STORE  
and WHOLESALE WAREHOUSE  
4900 LANKERSHIM BLVD.  
NORTH HOLLYWOOD, CALIFORNIA • Stanley 7-2113 - POplar 6-8668  
OPEN 9 TO 9 WEEKDAYS - SAT. 9 TO 6



**UNMATCHED  
PRICES & QUALITY  
IN OUR ENLARGED**

# Microphone Dept!



### 100-C Slim Crystal Microphone

Our Sales Leader in microphones. Smooth, rounded design tapering from 1 1/8" diameter for easy hand-held use. Has detachable shielded cable and slide on-off switch. Frequency range, 100 — 9,000 cps; sensitivity — 52 db; high impedance. Excellent for voice or music. Satin chrome finish case.

**\$3.95** <sup>3 FOR</sup> **\$9.95**



### MH-100 Mike Holder

For 100-C Microphone. Swivel cradler adapts Calrad 100-C Mike and other similar mikes for use on standard floor and desk stands. Has 3/8" — 27 thread in base and felt padded friction clamp jaws for holding mike. Beautiful chrome plated finish adds to appearance and utility of any microphone.

**95c**

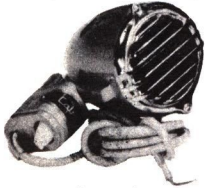

### 400-C Crystal Hi-Impedance Mike

Impressive appearance and performance. For general use and home recording. Semi-directional, head tilts to vertical for non-directional use. High output, — 52 db; essentially flat frequency response from 100 — 8,000. Compact size—2 3/8" diameter x 4 1/4" long x 4 1/8" high. Complete with 3/8" - 27 mounting thread and shielded cable. Silver grey baked enamel with chrome trim. Individually boxed.

**\$4.95**

### DM-12 Slim Dynamic Microphone

High-style design dynamic mike with excellent characteristics; for night-club, PA, and other uses where a high quality pickup of both voice and music is needed. Hi-impedance—50K ohms—with a flat frequency response from 60 to 12,000; sensitivity — 52 db. Streamline cobra design with satin chrome finish. Threaded for 3/8" - 27 mike stands. Complete with cable and mike connector; on-off switch.

**\$14.95**

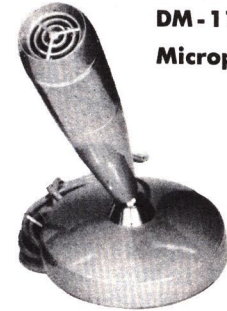
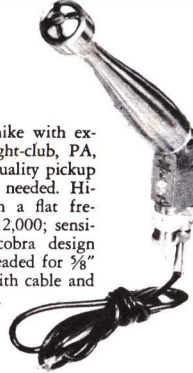

### DM-11 Dynamic Microphone

**\$16.95**

Modern, tastefully integrated design mike and stand. Wide range flat response from 60 to 12,000 cps. Omni-directional pick-up—sensitivity — 54 db; 50K ohms impedance. Stands vertically or tilts in any direction from wide base desk stand. Removes from desk stand and attaches to floor stand with 3/8" - 27 thread adapter provided. Finished in blue mist metallic lacquer with chrome trim. Supplied with shielded plastic covered cable, and packed individually. An elegant, yet practical instrument.

### 500-C Broadcast Type Crystal Microphone

Two separate phased crystal units mounted vertically for true 360° omni-directional pickup. Perfect for group and conference use; speaking, singing, or instrumental. Sensitivity,—50 db. Brass construction, beautifully finished in chrome and black. Frequency range, 80-8,000. Width, 3"; height, 7". Mounting thread, 3/8" - 27. Individually boxed with shielded plastic covered cable.

**\$6.95**



### D-600 Hi-Impedance Dynamic Microphone

An excellent microphone for speech and music. Frequency response, 60-9,000. Sensitivity, 56 db; impedance, 50K ohms. Mounting bracket has 90° swivel, with 3/8" - 27 thread. Beautiful Brown Hammertone finish, chrome trim, gray shielded plastic covered table.

**\$8.95**

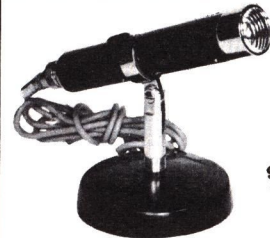
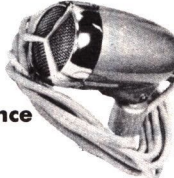

### DM-10 Dynamic Microphone and Stand

**\$12.95**

Slim style mike adjusts to optimum angle and readily removes from weighted non-tip desk stand for hand use. Rugged dynamic design with frequency response of 80 - 8,000 cps. Sensitivity, — 56 db; 50K ohm impedance. Finished in black with chrome trim, mike is 7 1/2" long and 1 1/8" in diameter. Comes with built-in on-off slide switch and shielded plastic covered cable.



### CM-75 Hand Carbon Mike

Complete with "push-to-talk" switch and cable attached. For PA and mobile use. Internal resistance—100 ohms. 70—7,000 cps; sensitivity—50 db. Brown plastic case; fits the hand, has loop for hanging.

**\$4.95**



### CC-1 Crystal Contact Mike

For musical instruments. Pickup is by direct contact with sounding board of instrument. Frequency response, 40 - 9,000 cps. Attaches without tools—will slip under bridge of string instruments. Complete with shielded cable and phone plug.

**\$3.49**



### M-28 Lapel Crystal Microphone

Small, rugged mike with moisture-proof crystal in chromed die-cast case. Has alligator type clip for lapel use. Non-directional, with — 55 db sensitivity, and a response range of 200 — 8,000 cps. High impedance mike has shielded plastic covered cable attached. Size, 1 1/8" diameter x 3/4". For general speech use, or experimental work.

**\$2.95**

### 700-C Crystal Microphone

Compact rectangular style case; ideal for home recorder applications, Hi-impedance crystal mike sits on desk, fits in hand, and is threaded for 3/8" — 27 mike stands. Amazing performance — 80—9,000 frequency range, — 50 db sensitivity, very stable. Sturdy metal case is finished in Gummetal Grey. May be easily concealed in pocket.

**\$3.95**

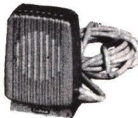

### D-350 4-WAY Dynamic Mike and Stand



**\$9.95**

A versatile microphone with desk stand and neck cord provided; 3/8" - 27 thread for floor stand. May also be used as hand mike because of its compact taper form. Hi-impedance, 50K ohms, omni-directional dynamic design; sensitivity, — 60 db; frequency response, 120 - 9,000. Complete with stand, neck cord, and shielded plastic covered cable. Individually packaged. Light blue hammertone finish with chrome trim.

## COLUMBIA ELECTRONIC SALES MAIL ORDER DEPT.

WHOLESALE — RETAIL STORE  
2251 WEST WASHINGTON BLVD.  
LOS ANGELES 18, CALIFORNIA • RPublic 1-2206  
OPEN MON. & FRI. TILL 9:00 P.M. — SAT. 9 TO 5:30

SAN FERNANDO VALLEY RETAIL STORE  
and WHOLESALE WAREHOUSE  
4900 LANKERSHIM BLVD.  
NORTH HOLLYWOOD, CALIFORNIA • Stanley 7-2113 — POplar 6-8668  
OPEN 9 TO 9 WEEKDAYS — SAT. 9 TO 6



# KEYS • EARPHONES • HI-FI HEADSETS

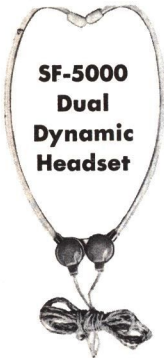

Two dynamic reproducers with separate connecting cords for two channel stereo reproduction. Matched 10 ohm reproducers have a frequency response of 40-16,000 cps for true hi-fidelity stereo listening. May be adapted for monaural use also. Comfortable to wear—extremely light (1½ oz.) weight. Clear plastic tubes with removable plastic earpieces. Individually packaged.

Cat. No. SF-5000

**3 49**



Matched dual reproducers for use with high output audio circuits. Hi-impedance; 70K ohms at 1 kc. Frequency response, 70 - 15,000 cps. Stethoscope type headset with both crystal reproducers mounted at the "Y". Clear plastic tubes carry the separate audio signals to the ears for completely private stereo hi-fidelity reproduction. Weights approx. 1½ oz. for comfortable under-the-chin use. Individually packaged.

Cat. No. SF-3000

**3.19**



**PERMOFLUX  
Hi-Fi  
HEADSET  
\$9.95**

**3 FOR \$26.95**

This fabulous headset is used for professional monitoring. Amazing frequency response and lack of distortion make these a real buy.



**CH-12 Crystal Stethoscope Headset**

Comfortable to wear under-the-chin design. Extremely lightweight high impedance crystal driver feeds into adjustable plastic ear tubes with removable rounded tips. Wide range; excellent reproduction characteristics. Packed complete with plastic covered cord.

Cat. No. CH-12

**\$ 1.95**

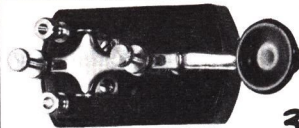

**99c  
3 FOR 250**

**TK-10 Calrad Telegraph Key**

Molded phenolic base and full size key knob. Key arm is adjustable, has tension spring and easy action bearing pivots. All metal parts plated—1/8" silver contacts. Standard size key has base 3/4" x 1 1/8" wide; 5" long overall. Knurled adjustment and binding post screws. Mounting holes in base. Individually packaged.

**RH-40 Radio Type Headphones**

**PROFESSIONAL TYPE**

RH 40 Radio type head phones supplied with leather head band. High impedance 4,000 ohms.

Cat. No. RH-40



**2 29**



**RH-20 Radio Type Headphones**

Hi-impedance—2,000 ohms—general use headset. Black and Ivory plastic cased electro-magnetic units with adjustable head-band for comfortable fit. Individual listening for all types of applications. Packaged individually, with flexible cord attached.

Cat. No. RH-20

**\$1.79  
3 FOR 4.50**



**DE-150 Dynamic "Hearing Aid" Type Earphone Kit**

Low impedance (15 ohms) high quality reproduction. Frequency response, 50 - 4,000 cps. Flesh colored plastic case and flex cord with miniature phone plug and closed circuit jack. Connects directly to secondary of output transformer; excellent for private radio and TV listening devices. Metal box allows use at either ear. Individually packed in plastic bag.

**2.29**

**HAVE A BALL!  
HAVE FUN WITH FRIENDS!  
WATCH MICROPHONE**

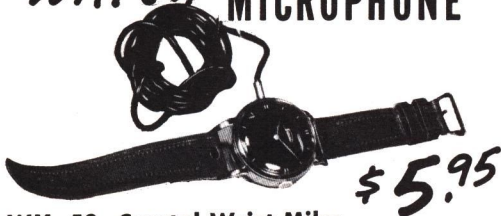

**WM-50 Crystal Wrist Mike**

Looks like a fine watch, is actually a sensitive microphone. Rugged high-gain crystal cartridge of 50,000 ohms impedance is omni-directional in use and gives the user a completely concealed microphone for recording or transmitting conversations. Frequency response, 75 - 9,000 cps. Underside of watch has chrome grillwork over mike cartridge; concealed wire goes up user's sleeve. Mike is beautifully chrome plated, has watch type face and hands and simulated winding stem. A beautifully executed design with quality leather band.

**\$5.95**

**A \$19.95 VALUE!**



**H-16 HEADSET high impedance. Complete with noise cancelling rubber cushions. Very comfortable. used-good cond.**

**95c 3 FOR 2.79**

**HEAVY DUTY MIKE STAND  
EXTENDS TO 5 1/2 FT.  
BEAUTIFULLY FINISHED IN CHROME AND UMBER GREY  
\$6.95  
QUANTITIES LIMITED ORDER NOW!**



**DE-160 Dynamic "Hearing Aid" Type Earphone Kit**

Low impedance, 2000 ohms or 5000 ohms high quality reproduction. Frequency response, 50 - 4,000 cps. Flesh colored plastic case and flex cord with miniature phone plug and closed circuit jack. Connects directly to secondary of output transformer; excellent for private radio and TV listening devices. Metal bow allows use at either ear. Individually packed in plastic bag.

Cat. No. DE-160 — 2000 ohms  
DE-5K — 5000 ohms

**\$2.29**

**CEP Crystal Earphone**

Extremely lightweight, compact and sensitive high-impedance type earphone. Has clear plastic earpiece which may be removed to allow use as crystal mike. For use with pocket radios, etc. Complete with cord. Packed in clear plastic bag. Less plug and jack.

**99c**

**KB-15 BUZZER CODE PRACTICE SET**  
Key and Buzzer on mounting board

New Boxed  
Uses regular flashlite battery **\$1.69**

## COLUMBIA ELECTRONIC SALES MAIL ORDER DEPT.

WHOLESALE — RETAIL STORE  
2251 WEST WASHINGTON BLVD.  
LOS ANGELES 18, CALIFORNIA • Republic 1-2206  
OPEN MON. & FRI. TILL 9:00 P.M. — SAT. 9 TO 5:30

SAN FERNANDO VALLEY RETAIL STORE  
and WHOLESALE WAREHOUSE  
4900 LANKERSHIM BLVD.  
NORTH HOLLYWOOD, CALIFORNIA • Stanley 7-2113 — POplar 6-8668  
OPEN 9 TO 9 WEEKDAYS — SAT. 9 TO 6



# PANEL METERS · MULTI-TESTERS

## TL-50 All-Purpose Test Lead Kit

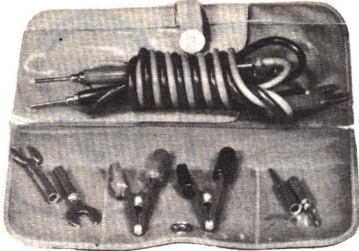

Red and Black 4½" plastic handle pin prods, with heavy duty 5,000 V insulation, 35" kinkless rubber leads terminating in red and black 2" plastic grip banana plugs. Choice of interchangeable terminals for various uses—all slip directly onto banana plugs. Spade lug terminals, color-coded alligator clips, or phone tips give positive solderless connection for universal use. All items packed in handy compartmented flexible plastic case with snap fastener.

**\$7.89**

## TL-20 Test Leads



**43c**

Extra flexible, kinkless standard test leads. One Red and one Black, 60 inches long, complete with 4" test prods and pin plugs.

**3 FOR \$1.10**

## Insulated Color Coded Alligator Test Lead Clip Set



Consists of 10 leads, 15" long, clip to clip. Plastic insulated alligator test clip on each end . . . 2 each of 5 colors.

**\$1.39**  
**3 FOR \$3.89**

D'Arsonval type movement panel meters with 1½" square face bakelite case. Meters fit into 1½" diameter hole in panel; may be placed in front or behind panel. Black bakelite case, with silvered dial and black numerals. Indicator hand and dial protected by clear glass. These meters are calibrated to be accurate within 2%. Have zero set screw adjustment.

Calrad Plastic front panel meters enable the user to have an extremely readable scale. Clear meter face is unbreakable and easy to clean. Will enhance the beauty on any equipment on which it is used. 1½ inch square.

## 1½" METERS

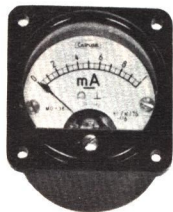

### Standard Face Meters

#### "DC" MICROAMMETERS

| Cat. No. | Range   |             |
|----------|---------|-------------|
| MO-38-3  | 0-50    | <b>3.95</b> |
|          | 50-0-50 |             |
|          | 0-100   |             |

| Specify Range |             |
|---------------|-------------|
| 0-200         | <b>5.25</b> |
| 0-300         | <b>5.25</b> |
| 0-500         | <b>5.25</b> |

#### "DC" MILLIAMMETERS

| Cat. No. | Range |             |
|----------|-------|-------------|
| MO-38-2  | 0-1   | <b>3.95</b> |
|          | 0-10  |             |
|          | 0-100 |             |

| Specify Range |             |
|---------------|-------------|
| 0-200         | <b>4.25</b> |
| 0-300         | <b>4.25</b> |
| 0-500         | <b>4.25</b> |

#### "DC" VOLTMETERS

| Cat. No. | Range |             |
|----------|-------|-------------|
| MO-38-1  | 0-15  | <b>3.95</b> |
|          | 0-30  |             |
|          | 0-200 |             |

| Specify Range |             |
|---------------|-------------|
| 0-200         | <b>4.25</b> |
| 0-300         | <b>4.25</b> |
| 0-500         | <b>4.25</b> |

#### "AC" VOLTMETERS

| Cat. No. | Range |             |
|----------|-------|-------------|
| CO-38    | 0-15  | <b>3.95</b> |
|          | 0-30  |             |
|          | 0-150 |             |

| Specify Range |             |
|---------------|-------------|
| 0-15          | <b>4.25</b> |
| 0-30          | <b>4.25</b> |
| 0-150         | <b>4.25</b> |

#### "DC" AMMETERS

| Cat. No. | Range       |             |
|----------|-------------|-------------|
| MO-38    | 0-10 amp DC | <b>3.95</b> |
|          | 0-30 amp DC |             |

## Clear Plastic Face Meters

| "DC" MICROAMMETERS | Specify Range |             |
|--------------------|---------------|-------------|
| Cat. No.           | Range         |             |
| CMO-38-3           | 0-100         | <b>5.65</b> |
|                    | 0-50          | <b>5.95</b> |
|                    | 50-0-50       | <b>5.95</b> |

| "DC" MILLIAMMETERS | Specify Range |             |
|--------------------|---------------|-------------|
| Cat. No.           | Range         |             |
| CMO-38-2           | 0-1           | <b>4.25</b> |
|                    | 0-10          | <b>4.25</b> |
|                    | 0-100         | <b>4.25</b> |

| "DC" VOLTMETERS | Specify Range |             |
|-----------------|---------------|-------------|
| Cat. No.        | Range         |             |
| CMO-38-1        | 0-15          | <b>4.25</b> |
|                 | 0-30          | <b>4.25</b> |
|                 | 0-500         | <b>4.25</b> |

| "AC" VOLTMETERS | Specify Range |             |
|-----------------|---------------|-------------|
| Cat. No.        | Range         |             |
| CCO-38          | 0-15          | <b>4.25</b> |
|                 | 0-30          | <b>4.25</b> |
|                 | 0-150         | <b>4.25</b> |

| "DC" AMMETERS | Specify Range |             |
|---------------|---------------|-------------|
| Cat. No.      | Range         |             |
| CMO           | 0-10 amp DC   | <b>4.25</b> |
|               | 0-30 amp DC   | <b>4.25</b> |

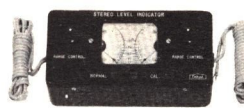

## Calrad Stereo Level Indicator Model S1-10

A dual visual audio level indicator affording positive and visual balance indication between two channels of a stereo system. Either record or playback. In addition stereo level indicator provides indication of power level preventing accidental overloading of either channel.

Connect one pair of leads from indicator to high impedance output jack of each pre-amplifier tape recorder outputs, or speaker terminals on rear of amplifier, throw switch to calibrate position. Then adjust each range control for the desired power level indication, making sure scale readings are identical. When switch is in normal position correct operation is indicated by equal readings.

Input—AC-DC (Maximum 400 Volts DC)

High or low impedance

Dual Scales—20 to plus 3 db and 0-100%

Size—6" long, 3" wide x 1½" high.

**9.95**



## Audio Level Indicator Model A1-5

The Calrad Audio Level Indicator is designed for use with Audio equipment indicating correct output level thus preventing accidental overload with resultant distortion. A range control provided on meter permits 100% level at any desired power. Connect leads from Indicator to high impedance output jack of pre-amplifier, or speaker terminals at rear of amplifier. Adjust range control for power level desired.

Input—AC-DC (Maximum 400 Volt DC)

High or low impedance.

Scales—20 to plus 3db and 0-100%.

Size—3¾" long, 2¾" wide, 1¾" high.

**\$7.95**

## SO-38 "S" Meter

Gives accurate measure of signal strength. A necessity for the amateur operator and SW listener, for giving signal reports and tuning receivers. Meter has a basic movement of 0-1mA. Calibration is from 0 to 9 "S" units, + 10 to + 30 db, and the full scale value of 1mA is divided equally from 0 to 5 and 0-10 on dial face.

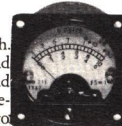

**\$4.95**

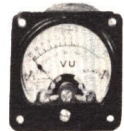

## VO-38 VU Meter

—20 to + 3 and 0-100% standard markings.

**\$5.95**

## Insulated Alligator Clips

Red or black plastic body clips with metal teeth. Fully insulated, convenient thumb-grips. Solder lug for attaching lead. Overall length 1¼". Specify color. **15c**

## AC-5 Plated Alligator Clip

Strong grip jaws plain alligator clip. For use in all types of testing equipment. Designed with a long thin nose to fit close areas or hard to get at places. 2 inches long. With screw. **10c**

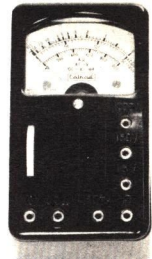

**\$7.50**

## TK-30A Multi-Tester

1,000 Ohms per Volt sensitivity DC. A midjet type volt-ohm meter having an easy-to-read direct reading dial—an excellent instrument for school, industrial, and service use. Reads AC or DC Volts in ranges of: 0-15, 0-150, and 0-1,000 Volts. Current is read from 0-150 ma. DC. Direct reading scale measures 0-100 K ohms DC. Handy zero adjustment. Bakelite case measures, 4 x 2¼ x 1¾". Test leads, self-contained batteries and instruction sheet included.



## TK-20 20,000 OHM Multi-Circuit Tester

**\$16.95**

Sensitivity of 20,000 ohms per volt DC-10,000 ohms per volt AC. Complete with test leads, batteries, and zero adjustment. Size 5½ x 3¾ x 2½". Has following ranges on scale: DC Voltage—1200 V, 600 V, 120 V, 30 V, 6 V, at 20,000 ohms per volt sensitivity. AC voltage—1200 V, 600 V, 30 V, 6 V, at 10,000 ohms per volt. DC current—60 ua at 1.2 ma, 12 ma, 300 ma. Resistances—Rx1, Rx10, Rx100, Rx1000 ohms. Decibels:—20 to 17. Capacitance: .005—.01 uf. Inductance—30-3,000 Henrys.



## TK-2000 OHM-Volt Meter

**\$13.95**

Sensitivity—2,000 ohms per volt, DC. Reads AC or DC volts in 5 ranges: 0-10, 0-50, 0-250, 0-500, and 0-1,000 Volts. Direct reading of Ohms, 0-10K and 0-1 Meg, through multiplier. Direct reading of decibels to 24 db at 10 Volts DC; 36 db at 50 Volts AC. Current is read in three ranges: 0-25, 0-500 mA, and 0-500 uA, DC. Easy to read dial faces. Meter has sturdy steel case, 5¼ x 3½ x 1½", with bakelite face. Panel switch has self-wiping contacts. Meter is packed with test leads, self-contained batteries and instruction sheet for easy reading of circuit values.

# COLUMBIA ELECTRONIC SALES MAIL ORDER DEPT.

WHOLESALE — RETAIL STORE  
2251 WEST WASHINGTON BLVD.  
LOS ANGELES 18, CALIFORNIA • Republic 1-2206  
OPEN MON. & FRI. TILL 9:00 P.M. — SAT. 9 TO 5:30

SAN FERNANDO VALLEY RETAIL STORE  
and WHOLESALE WAREHOUSE  
4900 LANKERSHIM BLVD.  
NORTH HOLLYWOOD, CALIFORNIA • Stanley 7-2113 — POplar 6-8668  
OPEN 9 TO 9 WEEKDAYS — SAT. 9 TO 6



**COLUMBIA** NOW OFFERS TWO OF THE LARGEST ELECTRONIC STORES AND WAREHOUSES TO BETTER SERVE THE ELECTRONIC FIELD. THOUSANDS OF INDIVIDUAL ITEMS AVAILABLE TOO NUMEROUS TO CATALOG. PLEASE SEND YOUR REQUESTS FOR PROMPT QUOTATIONS.



**ORDER NOW!** *use this* **SPEEDY ORDER FORM**

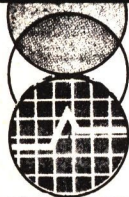

# Columbia SALES

## ELECTRONIC

AIRCRAFT-RADAR EQUIPMENT • SURPLUS RADIO PARTS & SUPPLIES • SHORAN • LORAN

HI-FI-STEREO-COMMUNICATIONS  
2251-53 WEST WASHINGTON BOULEVARD • LOS ANGELES 18, CALIFORNIA • REPUBLIC 1-2206

|   |   |  |
|---|---|--|
| <b>FROM:</b> (Name) _____<br>(Street) _____<br>(City) _____<br>(Zone) _____ (State) _____ | <b>SHIP TO ANOTHER ADDRESS? Give directions</b><br>Ship To (Name) _____<br>(Street) _____<br>(City) _____<br>(Zone) _____ (State) _____ | Leave This Box Blank<br><div style="border:1px solid black; height:60px; width:100%;"></div> |
|---|---|--|

| Do Not Use This Column | Quantity | Name of Item | On Catalogue Page | Unit Price | Total |
|------------------------|----------|--------------|-------------------|------------|-------|
|                        |          |              |                   |            |       |
|                        |          |              |                   |            |       |
|                        |          |              |                   |            |       |
|                        |          |              |                   |            |       |
|                        |          |              |                   |            |       |
|                        |          |              |                   |            |       |
|                        |          |              |                   |            |       |
|                        |          |              |                   |            |       |
|                        |          |              |                   |            |       |
|                        |          |              |                   |            |       |
|                        |          |              |                   |            |       |
|                        |          |              |                   |            |       |
|                        |          |              |                   |            |       |
|                        |          |              |                   |            |       |
|                        |          |              |                   |            |       |
|                        |          |              |                   |            |       |
|                        |          |              |                   |            |       |
|                        |          |              |                   |            |       |
|                        |          |              |                   |            |       |
|                        |          |              |                   |            |       |
|                        |          |              |                   |            |       |
|                        |          |              |                   |            |       |

**Ship by:**    **Check One:**    **PLEASE ENCLOSE ENOUGH TO COVER. PARCEL POST, OVERS WILL BE REFUNDED**    **TOTAL**  
 Parcel Post        Air        Freight        **MINIMUM ORDER \$3.50**    **SALES TAX**  
 Express        Cheapest Way        Truck        **TOTAL** (Calif. Only)

**NOTE: 25% DEPOSIT required on all orders. All prices F.O.B. Los Angeles, and subject to change without notice. All items subject to prior sale.**



**HUGE SAVINGS**

# TRANSFORMERS

**Saturating Reactor: Bendix # A117016;**  
 Primary 0 ADC/ .010 ADC to Z=  
 3000 ohm/ Z= 180 ohm.  
 Size: 2 3/4 x 2 3/4 x 4 1/2; Fully  
 cased and potted.....\$ 2.49

**Selenium Rectifier Transf.**  
 110 v. pri. Sec. 37-42-47v @ 5 amp.  
 marked 2 amps but puts out 5  
 Square case potted. new \$1.95

**Dynamic Mike Input transformer.**  
 Thordarson # ST-1005. 50K C.T.  
 primary to 8K secondary. Fully  
 cased and potted. 95-

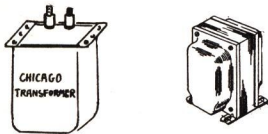

**AUDIO OUNCER Transformer**  
 Triad # JO-12  
 15Kohm Plate to 60K ohm C.T. to  
 Push-Pull grids. 45db shielding.  
 Size: 1 inch round by 1 3/4 high.  
 New in Triad box.....\$ 2.49

**PEERLESS Audio Choke.**  
 2.5 Henry @ 1000 cycles 3 ma.  
 120 ohm ; 500 volt insulation.  
 Size: 1 inch round x 1 3/8 high.  
 Fully cased and shielded.....49¢

**SWINGING CHOKE**  
 4-12 Hy @ 300 ma.  
 Made by Chicago for Collins.  
 Fully shielded and potted; these  
 are BRAND NEW and only \$ 3.95

**Instrument Isolation Transformer**  
 # 23011; Primary 115 VCT @ 7 ma.  
 Secondary 110 VCT @ 1 ma.  
 Size: 1 3/4 x 1 3/4 x 3 1/2 high;  
 fully cased and potted.....\$ 1.00

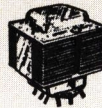

**Filament Transformer**  
 Pri. 117 v. 60 cyc.  
 Sec. 12 v. 3-4 amps.  
 hermetically sealed. Jan  
 terminals.  
 A Columbia special  
 at \$1.49

**# 20194**  
 Primary: 110 volt 60 cycle.  
 Secondary # 1 680 vct @ 140 ma.  
 Secondary # 2 5 volts @ 3 amp  
 Secondary # 3 6.3 v @ 1.5 A  
 Secondary # 4 6.3 v @ 3 amp  
 Fully shielded horizontal mounting.  
 Size: 3 3/4 x 4 1/2 x 3 1/4;  
 Made by Acme.....\$ 3.49

**# V-6198**  
 Primary 110 volt 60 cycle.  
 Secondary # 1 700 vct @ 150 ma.  
 Secondary # 2 6.3 vct @ 2.7 amp  
 Secondary #3 5 vct @ 3 amp  
 Fully cased and potted up mounting.  
 Size: 4 x 3 1/2 x 4 1/4; Made by  
 Vernon..... \$ 2.49

**HI-FI Audio output transformer.**  
 # T-24037. 25 Watt. Primary  
 6600 ohm C.T. for 6L6 or 5881.  
 Secondary 8 & 16 ohms. Frequency  
 response: 30 to 20,000 cycles + or  
 - 3 db. Size: 3 3/4 X 3 1/2 X 4 1/2;  
 Fully cased and potted.....\$ 5.88

**Transformers & Chokes**

32 H @ 40 ma. 540 ohm, potted,  
 small. New 39¢ 3/\$1.00  
 10H @ 150 ma 150 ohm 2kv ins.  
 Haldorson, potted. \$1.49 3/\$4.00

**Interstage Transformer. UTC # LS-20**  
 Ratio 2:1 Single plate to screen grid.  
 Primary 8000/15000 ohm  
 Secondary 60,000 ohm.  
 Size: 2 3/4 x 3 1/4 x 3 1/2. Fully  
 cased and potted.....\$ 2.49

**IF Transformers**

85 kc. from R-23/ARC-5 \$1.95 ea  
 3/ \$5.00  
 1200 kc from DAS-1 29¢ 4/\$1.00  
 1415 kc from R-26/ARC-5 95¢ ea.  
 3/\$2.50  
 1415 kc from TBX 49¢ ea.  
 4300 kc from GRC recr 39¢ ea.  
 3/\$1.00

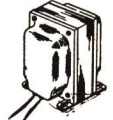

**Plate Transformer**

1000 volt each side C.T. 200 ma.  
 Hermetically sealed. ceramic  
 terminals. Primary 115-230 v.  
 60 cycles. Special \$6.95

**HI-FI Audio Output Transformer.**  
 #T-24038. 15 Watt. Primary  
 8000 ohm C.T. for 6V6. Secondary  
 8 H 16 ohm. Frequency Response :  
 30 to 20,000 cycles essentially flat  
 Size: 2 3/4 X 3 X 4; fully cased and  
 potted.....\$3.88

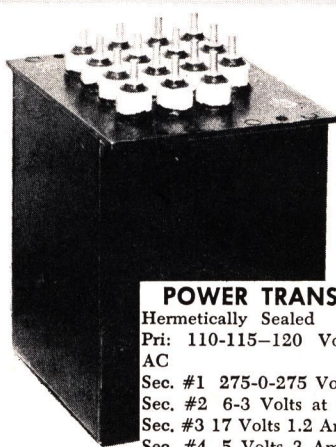

**POWER TRANSFORMER**

Hermetically Sealed  
 Pri: 110-115-120 Volts 60 cycles  
 AC  
 Sec. #1 275-0-275 Volts at 120 Ma.  
 Sec. #2 6-3 Volts at 11.1 Amps  
 Sec. #3 17 Volts 1.2 Amps  
 Sec. #4 5 Volts 3 Amps  
 Size 4-3/4" x 4" x 5" high. Weight  
 12 lbs 3 ozs.

PRICE \$ 3.95 ea  
 3 FOR \$10.00



**Line Output Transformer**

3-150 Ohms windings, 1-600 Ohms  
 winding (200 cycles to 4000 cycles)  
 1-150 Ohms winding carries 50 ma.

PRICE 70¢ ea.  
 6 FOR \$3.50

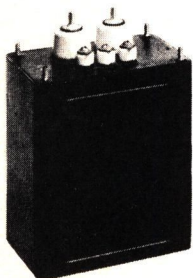

**866A FILAMENT TRANSFORMER**

Completely hermetically sealed. The  
 most beautiful 866A filament trans-  
 former we have ever handled. Pri-  
 mary: 115 VAC at 50 to 60 CPS.  
 Secondary: 2-1/2 volts at 10 amps.  
 Insulated for 12000 volts insulation.  
 Units are oil filled. Dimensions: Only  
 5" high x 4-1/2" wide x 3" deep.  
 New, unused in original mfgs cartons  
 Weight: 6 lbs 4 oz.

Price \$3.95

## COLUMBIA ELECTRONIC SALES MAIL ORDER DEPT.

WHOLESALE - RETAIL STORE  
 2251 WEST WASHINGTON BLVD.  
 LOS ANGELES 18, CALIFORNIA • Republic 1-2206  
 OPEN MON. & FRI. TILL 9:00 P.M. - SAT. 9 TO 5:30

SAN FERNANDO VALLEY RETAIL STORE  
 and WHOLESALE WAREHOUSE  
 4900 LANKERSHIM BLVD.  
 NORTH HOLLYWOOD, CALIFORNIA • Stanley 7-2113 - POplar 6-8668  
 OPEN 9 TO 9 WEEKDAYS - SAT. 9 TO 6



# RESISTORS · CONDENSER · SWITCHES · SOCKETS

**SPECIAL-BUY!**  
 **2 SEARCH LIGHT CELL**  
**LESS BATTERIES 39¢**

## REPLACEMENT SOCKETS



OCTAL RING MOUNT CERAMIC .13  
 " FLANGE " " .11  
 " " " PHENOLIC .10  
 LOCTOL RING " .11  
 7 PIN RING MOUNT CERAMIC .13  
 7 " JUMBO CERAMIC .13  
 4 " " " .25  
 9 " MINIATURE .10  
 7 " " " .10  
**BUY 5 GET ONE FREE!**

 **BAYONET PANEL MOUNT SOCKET**  
**5 FOR 39¢ 9¢ ea.**

 **12 POLE 3 POSITION SWITCH**  
**3 FOR \$1.00 39¢ ea.**

 **RED PANEL LIGHT ASSEMBLY, MIN. BAYONET BULB REMOVEABLE FROM FRONT**  
**3 FOR \$1.00 39¢ ea.**

 **RUBBER PLUG, FLUSH TYPE SIDE HOLE. 5 FOR 49¢ 12¢**

 **4 OUTLET WALL TAP, BROWN. 89¢**

 **DOUBLE OUTLET FOR WALL BOX BROWN 10 FOR 5.50 69¢**

 **Automatic Plug. No wire stripping. Just insert through cap. Sure-grip "needles" on prongs make positive connection through insulation. 15¢**

 **Rubber Cube Tap. Spring-action, 3-way outlet of one-piece, soft rubber. U. L. 25¢**

 **Flat Rubber Plug. Non-breakable molded rubber plug cap. Because of their narrow construction, these caps are ideal for use with multiple AC receptacles 15¢**

 **Bakelite Plug Cap. With convenient finger-grip Brown finish. 12¢**

 **Rubber-Handle Plug. Unbreakable soft-rubber. Approved for power tools. 15¢**





## TOGGLE SWITCHES

These brand new, bat handle toggle switches are priced to save you money.

|          |     |
|----------|-----|
| S.P.S.T. | 29¢ |
| S.P.D.T. | 37¢ |
| D.P.S.T. | 36¢ |
| D.P.D.T. | 42¢ |

write for quan. discounts.

 **Rotary, canopy type switch. SPST with wire leads. 39¢ ea.**  
**3 FOR \$1.00**

 **Push Button Switch normally open, spst momentary contact type. 33¢ ea.**  
**10 FOR 2.95**

 **YOUR CHOICE 9¢**  
**12 FOR \$1.00**

## Disc Ceramic Capacitors

|           |            |
|-----------|------------|
| 2.5 mmfd. |            |
| 10        | 47 mmfd.   |
| 15        | 100        |
| 22        | .0015 mfd. |



## Moulded plastic tubulars

|            |           |
|------------|-----------|
| .0015 mfd. | .015 mfd. |
| .002       | .068      |
| .0033      | .15       |
| .0068      | .33       |

**YOUR CHOICE 9¢ ea.**  
**12 FOR \$1.00**



## Wima Moulded Tubulars

Extra heavy duty construction to withstand extremes of heat moisture and shock, yet miniature in size.

|       |     |
|-------|-----|
| .001  | 13¢ |
| .0022 | 13¢ |
| .0033 | 13¢ |
| .0047 | 13¢ |
| .005  | 13¢ |
| .0068 | 16¢ |
| .01   | 16¢ |
| .015  | 16¢ |
| .022  | 16¢ |
| .033  | 16¢ |
| .047  | 20¢ |
| .05   | 20¢ |
| .1    | 25¢ |
| .22   | 31¢ |
| .47   | 44¢ |

Quantity prices available.

## Allen Bradley Resistors

10% tolerance



| Ohms | Ohms  | Ohms   | Megs | Megs |
|------|-------|--------|------|------|
| 10   | 220   | 4,700  | 0.1  | 2.2  |
| 12   | 270   | 5,600  | 0.12 | 2.7  |
| 15   | 330   | 6,800  | 0.15 | 3.3  |
| 18   | 390   | 8,200  | 0.18 | 3.9  |
| 22   | 470   | 10,000 | 0.22 | 4.7  |
| 27   | 560   | 12,000 | 0.27 | 5.6  |
| 33   | 680   | 15,000 | 0.33 | 6.8  |
| 39   | 820   | 18,000 | 0.39 | 8.2  |
| 47   | 1,000 | 22,000 | 0.47 | 10.0 |
| 56   | 1,200 | 27,000 | 0.56 | 12.0 |
| 68   | 1,500 | 33,000 | 0.68 | 15.0 |
| 82   | 1,800 | 39,000 | 0.82 | 18.0 |
| 100  | 2,200 | 47,000 | 1.0  | 22.0 |
| 120  | 2,700 | 56,000 | 1.2  |      |
| 150  | 3,300 | 68,000 | 1.5  |      |
| 180  | 3,900 | 82,000 | 1.8  |      |

Price: 1/2 watt 10¢ ea.  
 1 watt 13¢ ea.  
 2 watt 19¢ ea.  
 specify values required

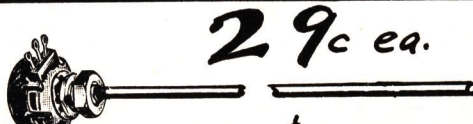
 **29¢ ea.**  
**4 FOR \$1.00**

## SPECIAL! SPECIAL!

Popular size 500,000 ohm pot with extra long shaft. stock up now and save.

# COLUMBIA ELECTRONIC SALES MAIL ORDER DEPT.

WHOLESALE - RETAIL STORE  
 2251 WEST WASHINGTON BLVD.  
 LOS ANGELES 18, CALIFORNIA • Republic 1-2206  
 OPEN MON. & FRI. TILL 9:00 P.M. - SAT. 9 TO 5:30

SAN FERNANDO VALLEY RETAIL STORE  
 and WHOLESALE WAREHOUSE  
 4900 LANKERSHIM BLVD.  
 NORTH HOLLYWOOD, CALIFORNIA • Stanley 7-2113 - POplar 6-8668  
 OPEN 9 TO 9 WEEKDAYS - SAT. 9 TO 6



**COLUMBIA  
SELLS FOR  
LESS!**

# TRANSISTOR COMPONENTS





**6 TRANSISTOR  
RADIO KIT  
\$17.95**

**K-300 Six Transistor Super-Het Kit**

Complete kit and circuit diagram with parts including leather case, 2½" speaker, and earpiece for private listening—plug and closed-circuit jack included. Everything you need, LESS TRANSISTORS, BATTERIES AND DIODE. Stiff leather handle may be used as a stand for supporting set at an angle. A tremendous value with amazing performance, sensitivity and selectivity. All parts are of miniature or sub-miniature size making a set 6" x 3½" x 1½". Ideal for schools, amateurs, or hobbyists wishing to build their own transistor radios. Push-pull output. Uses 1—RCA 2N 140, 2—2N 139, and 3—2N109 Transistors, plus RCA 1N 64 or 1N 34 Diode, or equivalent parts of another brand. Each kit packaged separately. Uses four 1½" Volt penlight cells as power source.

**35c MJ-27 Miniature Jack**   
**3 FOR 99c** Black ribbed plastic 2-way miniature in-line jack. Solder terminals.

**PJ-28 Shielded Miniature Plug and Jack**   
 2-way miniature shielded plug and closed-circuit jack. Plated finish. Solder terminals. **59c**  
**3 FOR \$1.69**

**49c Miniature Bakelite Plug and Jack**   
 2-way plug in either black or red. Closed-circuit jack included.

**Sub-Miniature Plug and Jack**   
 Red or black bakelite 2-way plug with closed-circuit jack. Plug is ¼" dia. x 1¼" with ⅛" shaft. Jack extends only ¾" behind panel and will mount on panel up to 3/16" thick. Solder terminals and cable clamp. **49c**

**TV-100 MINIATURE VOLUME CONTROL**  
 Less switch—for transistor and sub-miniature tube applications. Only ¾" dia. x 0.4 inch including threaded shaft. Use with radios, hearing aids, etc.  
 Specify range desired.  
 0 - 2500 ohms    0 - 500 K  
 0 - 5000        0 - 1 Meg  
 0 - 10 K        Cat. No. TV-100  
**49c**

Ideally suited and selected for building radio and amplifier sets with standard type transistors. High vacuum impregnation and application of a special coating, seals the coils. To attain such excellent characteristics in so small a transformer, a special core of hydrogen heat treated alloy is used. High quality at low cost. Compact—CR-60 is ½" x ½" x ½", others are ¾" x ¾" x ¾". Color coded wire leads. Instruction sheet and circuit diagram included with each transformer.

**89c**   
**YOUR CHOICE**  
**3 FOR \$2.49**  
 Cat. No. CR-70 ¾" x ¾" x ¾" Driver. Pri. 10,000 ohms, Sec. 2,000 C.T. DC resistance: Pri. 700 ohms, Sec. 127 ohms.  
 Cat. No. CR-80 ¾" x ¾" x ¾" Output. Pri. 500 ohms C.T., Sec. 3.2 ohms. DC resistance: Pri. 43 ohms, Sec. 0.27 ohms.

**3-PIN TRANSISTOR SOCKETS**   
 Molded mica, filled phenolic rectangular sockets with snap-on mounting clip. ¼" high x 3/16" wide x ⅜" long overall. Plated contacts and solder terminals for positive low resistance connection.  
**15c each 10 FOR \$1.29**

**TRANSISTOR OSCILLATOR COIL**   
 Unshielded, 5 wire type. Use 100 - 125 mmf oscillator cut-plate section variable condenser; or use with a 2-gang 365 mmf variable condenser and a 400 to 500 mmf series padder, 540-1650 K.C. Sizes 5/16" dia. x ¾". Cat. No. OC-1  
**59c**

**455 KC. I.F.'S AND OSCILLATOR COILS**   
 Available Separately  
 Identical to those shown above. 5-prong plug-in or wire type. Slug tuned, ferrite core, shielded I.F. coils. Engineered for maximum performance with transistors. ⅜" square x ⅜" high.  
 Cat. No. Description  
 PV-103 1st I.F.  
 PV-104 2nd I.F.  
 PV-105 Shielded Osc. Coil tunes with CR-200, Variable Condenser described on this page.  
**89c**

**MINIATURE TRANSISTOR I.F. COILS**  
 5-prong plug-in or wire type. Slug turned, ferrite core, shielded I.F. coils. Engineered for maximum performance with transistors. ⅜" square x ⅜" high. Frequency 455 KC.  
 Cat. No. TR-102—1st Stage I.F. Pri. 25,000, sec. 600 ohms.  
 Cat. No. TR-103—2nd I.F. Pri. 25,000 ohms, sec. 1000.  
**89c**

**PM-1½ Miniature PM Speaker**   
 1½" diameter, 1" deep. Especially designed for tiny equipment. Amazing tone quality in a small package for transistor and sub-miniature tube applications. Wide response. Precision manufacture. Ideally suited for pocket radios, miniature amplifiers, etc. 3.2 ohms impedance.  
**1.89 3 FOR \$5.50**

**PM-2 2-inch Miniature PM Speaker**   
 Extremely well-built Miniature Speaker with heavy Cadmium plated frame and fully enclosed pot cover. Full range response. 2" x 2" x 1½", overall size. Convenient solder lugs for connection. 3.2 ohms voice coil. For transistor or tube circuits. Good, clean audio from a compact, quality speaker.

## CONDENSERS

**MIDGET VARIABLE CONDENSER WITH DIAL**   
 Single condenser for all transistor and RF uses. 365 mmfd capacity. Single hole mount in 5/16" hole. 1" square x ½" deep. 1¼" diameter clear plastic dial with gold letters and knurled edges for easy tuning.  
 Cat. No. CR-210  
**89c**

**MIDGET VARIABLE CONDENSER**   
 Same as CR-210, less dial. Has standard ¼" solid shaft, ¾" long. Single hole mount.  
 Cat. No. CR-220  
**79c**

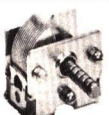
**SEMI-MIDGET VARIABLE CONDENSER**   
 Extremely compact single gang 365 mmf variable condenser. Ball bearing tuning action. Base or panel mounting in space 1¼" w. x 1¼" h. x 1" d. Brass ¼" shaft is ⅞" long, grooved for cutting to length. Individually boxed. Cat. No. CR-230  
**79c**

**SMALL 2-GANG VARIABLE CONDENSER**   
 Designed specifically for transistor superhet application. Dust-tight plastic case mounts with 2 screws to panel, has two trimmer screws at rear. Plates rotate through 175°. Stable capacitance—Antenna section, 11 uuf to 235 uuf; Oscillator, 11 uuf to 111 uuf. 1¼" square by ⅜" deep. Shaft ¼" diameter, ⅜" long.  
 Cat. No. CR-200  
**1.49**

**ELECTROLYTIC CONDENSERS FOR TRANSISTOR AND MINIATURE APPLICATIONS**  
 Small, dry electrolytic tubular condensers for portable and miniature equipment. Sealed in tubular aluminum cases. Insulated with a vinyl plastic sleeve.

| 12 Volts Working |           |              |     |
|------------------|-----------|--------------|-----|
| Cat. No.         | Cap. Mfd. | Size D. X L. |     |
| TC-312           | 3         | ¼" x ¾"      | .23 |
| TC-612           | 6         | ¼" x ¾"      | .24 |
| TC-1012          | 10        | ¾" x 1½"     | .29 |
| TC-3012          | 30        | ¾" x 1½"     | .33 |
| 15 Volts Working |           |              |     |
| TC-115           | 100       | ½" x 1¼"     | .39 |
| 25 Volts Working |           |              |     |
| TC-125           | 1         | ¼" x ¾"      | .21 |
| TC-325           | 3         | ¼" x ¾"      | .23 |
| TC-625           | 6         | ¾" x 1½"     | .25 |
| TC-1025          | 10        | ¾" x 1½"     | .25 |
| TC-3025          | 30        | ¾" x 1½"     | .39 |

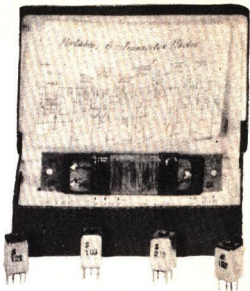
**MATCHED KIT OF MINIATURE TRANSISTOR COILS**   
 All coils are shielded plug-in or wire type; 3 I.F.'s and one 455 KC Oscillator, carefully matched for building a six transistor receiver of high quality. High-Q loopstick included. Specification sheet and wiring diagram supplied with each coil kit.  
 Cat. No. Tunes with dual section 365 mmf. Variable Condenser. Uses PV-100 Loopstick.  
 Cat. No. Tunes with 2-Gang Calrad No. CR-200. Uses PV-200 Loopstick.  
**\$ 3.95**

**HI-Q LOOPSTICK ANTENNAS**   
 Litz winding over high Q ferrite core. Flat, compact size—3⅜" x ¾"  
 Used with transistor circuits.  
 Cat. No. Tunes with Dual 365 mmf. PV-100 Variable Condenser.  
 Cat. No. Tunes with 2-Gang PV-200 No. CR-200  
**89c**

**TA-5 MINIATURE TELESCOPING ANTENNA**   
 For miniature pocket and transistor radios, Transceiver Applications and Amateur use. Made of chrome plated brass, antenna has 5 sections—pulls out to 38 inches extension, plugs into jack provided. Retracts to 9 inches for carrying in pocket. Flexible plastic case with protecting flap included.  
 Cat. No. TA-5  
**\$1.39**

**MINIATURE CONTROLS WITH DPST. SWITCH**   
 Designed to provide extremely smooth, quiet operation. Have semi-Log (audio) taper. Fits ⅝" hole in panels up to ¼" thick, ¼" shaft, ¾" long, diameter ¾" x 7/16" deep.  
**89c**  

| Cat. No. | Value  |
|----------|--------|
| TV-300   | 5K     |
| TV-300   | 10K    |
| TV-300   | 100K   |
| TV-300   | 500K   |
| TV-300   | 1 Meg. |

**3 FOR 2.50**  
 Specify Resistance

# COLUMBIA ELECTRONIC SALES MAIL ORDER DEPT.

WHOLESALE - RETAIL STORE  
 2251 WEST WASHINGTON BLVD.  
 LOS ANGELES 18, CALIFORNIA • Republic 1-2206  
 OPEN MON. & FRI. TILL 9:00 P.M. - SAT. 9 TO 5:30

SAN FERNANDO VALLEY RETAIL STORE  
 and WHOLESALE WAREHOUSE  
 4900 LANKERSHIM BLVD.  
 NORTH HOLLYWOOD, CALIFORNIA • Stanley 7-2113 - POplar 6-8668  
 OPEN 9 TO 9 WEEKDAYS - SAT. 9 TO 6



# SWITCHES · KNOBS · ACCESSORIES

## Hi-Fi Control Knobs

Trim, functionally styled knobs in keeping with the best in Hi-Fi equipment. Fluted taper cylinder design, with aluminum ring in recessed face. For tuners, amplifiers, etc. Available in 3 sizes and 3 colors. Order by catalog number.

|                                       |                      |                      |                      |
|---------------------------------------|----------------------|----------------------|----------------------|
| <b>Black Knob</b><br>Aluminum<br>Ring |                      |                      |                      |
|                                       | 117 LB<br><b>44c</b> | 117 MB<br><b>35c</b> | 117 SB<br><b>25c</b> |
| <b>Grey Knob</b><br>Aluminum<br>Ring  |                      |                      |                      |
|                                       | 118 LG<br><b>44c</b> | 118 MG<br><b>35c</b> | 118 SG<br><b>25c</b> |
| <b>Black Knob</b><br>Brass<br>Ring    |                      |                      |                      |
|                                       | 119 LB<br><b>44c</b> | 119 MB<br><b>35c</b> | 119 SB<br><b>25c</b> |
| <b>Ivory Knob</b><br>Brass<br>Ring    |                      |                      |                      |
|                                       | 120 LI<br><b>44c</b> | 120 MI<br><b>35c</b> | 120 SI<br><b>25c</b> |

Small: 1" dia. x 1 1/8" deep. Med: 1 1/8" dia. x 1 1/8" deep. Lge: 1 1/8" dia. x 3/4" deep. All knobs have white indicator line opposite set screw.

## Instrument Control Knobs

Molded bakelite instrument knobs with molded-in brass inserts and set screws to fit all standard 1/4" shafts. Three basic sizes are available in either Ivory or Black, each with its own contrasting pointer marking. Skirted easy-grasp rounded knob has wide flutes for easy, positive adjustment. Designed to enhance the appearance of any instrument.

|                      |                      |                      |
|----------------------|----------------------|----------------------|
|                      |                      |                      |
| 101 LB<br><b>39c</b> | 101 MB<br><b>29c</b> | 101 SB<br><b>24c</b> |
| <b>IVORY</b>         |                      |                      |
|                      | 100 LI<br><b>39c</b> | 100 MI<br><b>29c</b> |
|                      |                      | <b>24c</b>           |

1 1/2" dia. x 1" deep 1 1/4" dia. x 3/4" deep 1" dia. x 3/4" deep

## Radio Control Knobs

Beautiful, modern styling for all applications. Highest quality knobs of bakelite and plastic, with molded-in brass inserts and set screws for all standard 1/4" shafts. Supplied in sizes, shapes and colors as described below. Order by catalog number and specify quantity.

|  |  |   |  |
|--|--|---|--|
| <b>BROWN</b> with<br>convex gold<br>metal insert<br>in center.     |  |   |  |
|  | NO 16<br>1 3/8" dia. x 1"<br><b>35c</b>        | NO 17<br>1 1/8" dia. x 3/8"<br><b>24c</b> | NO 25<br>1 1/8" dia. x 7/16"<br><b>24c</b> |
| <b>IVORY</b> with<br>convex gold<br>metal insert<br>in center.     |  |   |  |
|  | NO 18<br>1 3/8" dia. x 1"<br><b>35c</b>        | NO 19<br>1 1/8" dia. x 3/8"<br><b>24c</b> | NO 27<br>1 1/8" dia. x 7/16"<br><b>24c</b> |
| <b>BROWN</b> with<br>gold metal<br>insert, round<br>fluted design. |  |   |  |
|  | NO 42<br>1 1/4" dia. x 9/16"<br><b>24c ea.</b> | NO 43<br>1 1/8" dia. x 3/8"               |  |



## TS-10 SPST Switch

Bakelite case, bat handle, with chrome On-Off plate. Solder lug terminals. 125V —3A. Packed 10 to a box. 1 1/4" x 3/8" x 1" deep to top of 3/8" bushing.

Cat. No. TS-10. **4 FOR \$1.00 29c**



## TS-12 DPDT Switch

Bat handle switch with chrome On-Off plate. Bakelite case, six solder terminals. 125V, 3A. Packed 10 to a box. 1 1/4" x 3/4" x 1 1/4" deep. 3/8" bushing.

Cat. No. TS-12. **3 FOR \$1.29 49c**



## TS-16 DPDT Switch

Bat handle center-off toggle switch with bakelite case. Red and black On-Off plate. Six screw terminals. Packed 20 to a box. 1 3/8" x 3/4" x 1 3/8" deep. 125V - 6 amp, 250V - 3 amp rating. 3/8" bushing.

Cat. No. TS-16. **69c**

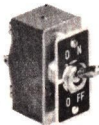

## Heavy Duty Toggle Switches

10 Amps. 125V or 5 Amps. 250V bat handle toggle switch. Enclosed in mica filled plastic case. Red and black On-Off plate. Tempered beryllium copper contacts. 1 1/8" long x 1" x 1 1/2" deep. Bushing is 3/8". Lug terminals. Std.

Cat. No. Action TS-2 SPST TS-6 DPDT **\$1.39**

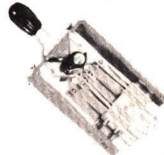

## 4-Pole DT Switch Telephone Type

Cam roller actuator. Ideal for control panel use. Smooth, quiet, positive action. 1-5/16" x 3/8" x 2 1/8" behind panel. Black lever handle. With mounting screws. Individually boxed.

Cat. No. LS-4 **\$1.25**



## Push Button Switch

SPDT spring return. Red plastic knob. Excellent for all miniaturized applications. 11/16" deep overall, 1/4" bushing and 1/2" overall diameter. Std.

Cat. No. PB-1

## 3-Way Auto Speaker Switch



Rotary switch for selecting either front or rear, or both auto radio speakers. Positive contacts, plated solder terminals. Has split 1/4" knurled shaft, 3/8" long. 3/8" bushing mounts through dash or panel.

Cat. No. SS-1 **29c**

## STD. 1 1/4 inch Bar Knob

Bakelite bar knob with brass bushing and set screw for 1/4" shaft. Choice of Red, Ivory or Black.

|   |                      |                      |
|---|----------------------|----------------------|
|   |                      |                      |
| Cat. No. BK-1R—Red  | Cat. No. BK-1I—Ivory | Cat. No. BK-1B—Black |
|   |                      | <b>9c</b>            |
|   |                      |                      |
| Fluted plastic pointer knobs. Diameter is 3/4", depth 3/8". Molded in two colors. | Cat. No. 150B Black  | <b>9c</b>            |
|   | Cat. No. 150W White  |                      |

## VC-20 Fader Control



20 ohm volume control for use as rear seat speaker fader control. Front, rear or both. Can also be used as a volume control for any small speaker having a voice coil impedance of 4, 8 or 16 ohms. 1 1/8" diameter. 1/4" threaded bushing. 3/8" slotted knurled shaft. Supplied with nut and washer.

Cat. No. VC-20 **63c**

## DPDT Slide Switch



Positive action slide switch, with plastic handle. Size 1 3/8" x 1/2"; 1 1/8" mounting centers. 125V, AC or DC, .5 amps. Std.

Cat. No. DPDT **19c**

## SPST Slide Switch



Positive action slide switch, with plastic handle. Size 1 3/8" x 1/2" x 1 1/8", mounting centers. 125V, AC or DC, .5 Amps. Std.

Cat. No. SS-2 **16c**

## KS-2 DPDT Knife Switch



Plated contacts for positive low resistance connection. Body and insulated knob handle are of black bakelite. Overall size is 1 1/2" x 2 3/8". Sturdy construction. Screw terminals. Individually boxed.

Cat. No. KS-2 **25c**

## SM-1 Super Magnet Motor No. 1

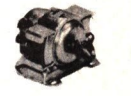

Dimensions: 1 3/8" x 1" x 1". Operates on one to three flashlight batteries (1 1/2 to 4V), 3 V operating voltage. 600 rpm at 1.5 V to 5600 rpm at 3V, no load. Weight: 2 oz. Individually boxed.

Cat. No. SM-1 **99c**

## SM-2 Super Magnet Motor No. 2



More power than No. 1. 1 3/4" x 1 1/4" x 1-3/16. 1 1/2 to 4 1/2 Volts. No load speeds of 3300 rpm at 1.5 V to 4800 at 3 V operating voltage. Individually boxed. Weight 3 oz.

Cat. No. SM-2 **\$1.29**

## SM-4 Super Magnet Motor No. 4



Gives greater power on 1 to 5 batteries (1 1/2 to 8 V) with speeds of 2000 rpm at 1 1/2 V to 3800 rpm at 3 Volts, no load. Operating voltage is 6V. Weight: 6 oz. Individually boxed.

Cat. No. SM-4 **\$2.22**

# COLUMBIA ELECTRONIC SALES MAIL ORDER DEPT.

WHOLESALE — RETAIL STORE  
2251 WEST WASHINGTON BLVD.  
LOS ANGELES 18, CALIFORNIA • Republic 1-2206  
OPEN MON. & FRI. TILL 9:00 P.M. — SAT. 9 TO 5:30

SAN FERNANDO VALLEY RETAIL STORE  
and WHOLESALE WAREHOUSE  
4900 LANKERSHIM BLVD.  
NORTH HOLLYWOOD, CALIFORNIA • Stanley 7-2113 — Poplar 6-8668  
OPEN 9 TO 9 WEEKDAYS — SAT. 9 TO 6





# WIRELESS

- ★ NO INSTALLATION REQUIRED—JUST PLUG IN
- ★ ONE UNIT
- ★ NO WIRING NEEDED
- ★ COMPLETELY PORTABLE
- ★ SO SIMPLE EVEN A CHILD CAN OPERATE IT!

Use with any existing Home, Car or Portable Radio  
 TAKE IT ANYWHERE — USE IT ANYWHERE (Even a battery-operated radio)

WHEN TRAVELING! VISITING! VACATIONING OR AT HOME

Simply plug in like a lamp and flick the switch. That's all! The sound you are listening for, the voice you are waiting to hear — comes in "Crystal Clear" on your own home or car radio, no matter where you are, in your home, outdoors, or while visiting neighbors 300 feet away. Finished in attractive Blue Baked Enamel.



**\$12.00**



# SMALL TALK

TWO-STATION INTERCOM SYSTEM

*Sensitive! Powerful!*

READY TO OPERATE —  
 NOTHING MORE TO BUY

COMPLETE WITH 50FT. CABLE



TWO STATION SYSTEM **\$18.75**

MODEL RSW—Extra Remote Station for Small Talk. (One extra Remote Station may be used in parallel with the one Remote normally supplied).

**\$ 7.75**

ALL MASCO PRODUCTS SHOWN ARE UNDERWRITER LABORATORIES APPROVED AND C.S.A. AND CARRY CONSUMER PRODUCT INSURANCE.

# E-Z TALK®

## ELECTRONIC TWO STATION INTERCOM SYSTEM

COMPLETE WITH 50FT. CABLE



FEATURES:

**MASTER** — Volume Control with on-off switch • Separate "Talk-Listen" switch • For 110 volts AC or DC • Uses less power than most light bulbs • Master controls both sides of a conversation and can listen-in to the Remote Station at will.

**REMOTE** — User can answer calls through the Remote from a distance • No need to operate a switch on the Remote • Remote is always "alive" (when the Master's power is on) for baby-sitting or dictation or as a safety listening device.

Two Station System

**\$ 13.80**

MODEL REL Extra Remote Station for E-Z TALK. (One extra Remote Station may be used in parallel with the one Remote normally supplied.) **\$5.25**

FEATURES

**MASTER:** Can be used on AC or DC • Uses no more current than a small night light • Volume control with on-off switch • Separate "Talk-Listen" switch • On-off pilot light • Ample Sensitivity — Natural Voice Reproduction • Underwriters' Laboratories Approved.

**REMOTE:** "Talk-Listen" switch allows Remote to originate calls to Master • Remote can be made "private" or "non-private" at will • Remote can answer calls from a distance without operating a switch • Remote can be left "open" for baby-sitting or dictation, called "Non Private" or "closed" for privacy but still able to receive calls from the Master "called Private"

# WIRE-LESS-COM

"NO WIRES"



A COMPLETE SYSTEM  
 READY TO OPERATE  
 • NO INSTALLATION  
 • NO CABLES  
 • JUST PLUG IN AND TALK

Two Station System  
 WIRE-LESS-COM **\$32.00**

Model SLC additional single station for Wire-less-com System. **\$15.50**

# COLUMBIA ELECTRONIC SALES MAIL ORDER DEPT.

WHOLESALE — RETAIL STORE  
 2251 WEST WASHINGTON BLVD.  
 LOS ANGELES 18, CALIFORNIA • Republic 1-2206  
 OPEN MON. & FRI. TILL 9:00 P.M. — SAT. 9 TO 5:30

SAN FERNANDO VALLEY RETAIL STORE  
 and WHOLESALE WAREHOUSE  
 4900 LANKERSHIM BLVD.  
 NORTH HOLLYWOOD, CALIFORNIA • Stanley 7-2113 — POplar 6-8668  
 OPEN 9 TO 9 WEEKDAYS — SAT. 9 TO 6



# PORTABLE COMMUNICATION EQUIPMENT

## SERIES JRC **VOCALINE** 2-WAY RADIO RADIO TRANSCEIVER

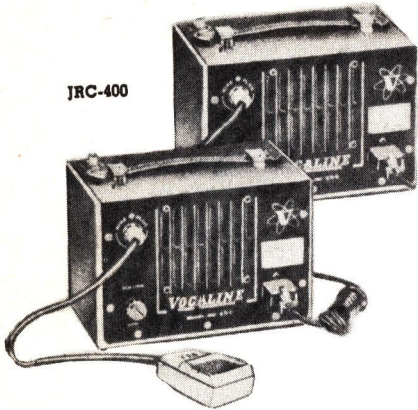

JRC-400

**Model JRC-425.** Same as above except features: Push-to-talk switch on microphone itself. Specially designed press-to-talk relay operating efficiently at the high frequency of this transceiver. Provisions for earphones. Complete with stainless steel microphone and push-button control and earphone jack. Also AC and DC line cords and plug-in antenna.

Two units. **NE 159.60**

**Model JRC-425-12.** As above, but for 12v.  
**NET 159.60**

## 2-WAY RADIO

### VOCALINE TRANSCEIVERS

**Model JRC-400.** Low-priced two-way radio. Operates on 465 mc Citizens Band. Two units supplied. Fixed frequency operation, no tuning. Loudspeakers for clear voice reproduction. Approved for Class B Citizens Radio . . . requires only station license. FCC approved. RF power input, 2 watts, 1/2 watt output. Two line cords supplied, one for 115v, the other for instant conversion to 6v DC. 9x6x5"

Two units. **NET 111.60**

**Model JRC-400-12.** As above, but 12 volts. **NET 111.60**

Type GP4-10 ground plane antenna for interior to exterior communication. **NET 6.36**

**Model GP5-50.** As above but 50' low loss lead-in wire. Perfect for rooftop.

**NET 19.96**

DC line cord fits cigarette lighter.  
**NET 2.95**

**Model AD-3.** Directional Antenna for increasing range to 40 miles or more.  
**NET 19.96**

**REQUIRES NO OPERATOR'S LICENSE,**  
 Special Skill or Knowledge. (Station License easily obtained by any U. S. Citizen over 18)

## MODEL CUB-1/MT-1

NET  
**\$179.50**  
COMPLETE



No additional antenna required  
Very efficient fixed station transmitter-receiver for roof top mounting. Remote controlled.

**RADIO SET AN/PRC-6** is a miniature, low-power, battery-operated radio receiver and transmitter designed for communication over short distances. Highly portable, it is intended primarily as a handy-talkie for foot combat troops; no skill is required to operate it. **\$95.00 EACH**

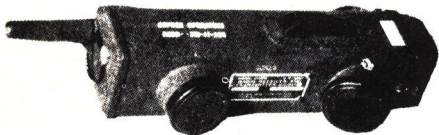
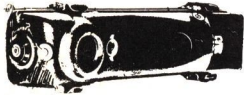

### BC-611 WALKY-TALKY

Complete unit, ready for operation. Waterproofed and very rugged. As shown above.  
**\$49.50 EA.**  
**2 FOR \$90.00**

For complete specs. see next column.

### NEW, WALKY-TALKY (BC-611) CHASSIS

Here's the chance to build your own real compact, lightweight hand-held Walky-Talky! Designed to transmit and receive on one (crystal-controlled) frequency between 3.0 and 6.0 mc., any real Ham could revamp the coils for operation on higher frequency amateur phone bands. This will result in increased antenna power output and longer distance transmission. By building your own case for this chassis, with space for larger batteries and increased B voltage, further increased power and longer service from batteries will result. These chassis are NEW, unused, complete with telescoping antenna but less tubes, coils, or crystals. Tubes required: 1-1R5, 1-185, 1-1T4, and 2-384, 2 miniature plug-in coils required (sold separately), 1-Antenna, and 1-RF Tank. Battery voltages required (original) 1-1.5 volt "A" and 103.5 volts "B" battery, the latter may be increased to 135 or 167.5 volts to produce higher transmitter output. Supplied as specified with Schematic diagram. Shpg. wt. 6 lbs. **5.95 EACH**—Chassis only . . . . . **5.95**

PAIR OF COILS, for above, Ant. & RF Tank . . . **\$1.25**

**35-25 KC COIL & CRYSTAL SET \$ 2.95**

### EMERGENCY TRAN/REC. FOR AIRCRAFT, SHIP, GROUND OR A FINE WALKIE TALKIE

Operates on VHF & UHF Aeronautical mobile distress Freq 121.5 Mc (VHF) 243.0 (UHF)

Unit has A1, A2, A3, emission self contained resonant ant. Operates from small battery pack.

Ground to air range approx. 200 miles VHF distress freq. monitored 24 hrs a day continuous in every country in the world. Approx. size: 6 1/2 x 3 1/2 x 2

**\$39.50**



**TBY**  
WITH DC PWR.  
SUPPLY ANT. MIKE  
AND HEADSET  
**\$32.45**

**BATTERIES FOR ABOVE RADIO SETS**  
for BC-611 . . . . . complete set . . . \$4.95  
for AN/PRC-6 . . . complete set 95¢ ea. or 16 for \$12.00

# COLUMBIA ELECTRONIC SALES MAIL ORDER DEPT.

WHOLESALE - RETAIL STORE  
2251 WEST WASHINGTON BLVD.

LOS ANGELES 18, CALIFORNIA • REpublic 1-2206

OPEN MON. & FRI. TILL 9:00 P.M. - SAT. 9 TO 5:30

SAN FERNANDO VALLEY RETAIL STORE  
and WHOLESALE WAREHOUSE

4900 LANKERSHIM BLVD.

NORTH HOLLYWOOD, CALIFORNIA • Stanley 7-2113 - POplar 6-8668

OPEN 9 TO 9 WEEKDAYS - SAT. 9 TO 6



# COMMUNICATIONS EQUIPMENT

## MAR

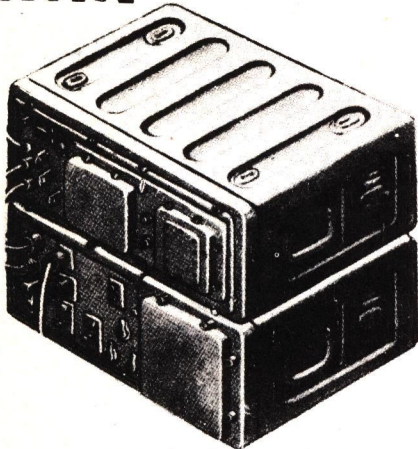

The MAR Radio Communication System has been developed as a general purpose transmitter and receiver, adaptable to a wide range of operating conditions and power supply characteristics. The equipment operates on any one of ten pre-set frequencies within the 225 to 390 megacycle band and provides both phone and MCW communication as desired. Both transmitter and receiver are tuned automatically to the selected frequency channel by a motor driven mechanism for rapid frequency change. Power input may be 12 Volts D.C., 115 Volts A.C. 60 Cycles or 230 Volts A.C. 60 Cycles..... **\$ 39.95**  
**EXC. COND.**

## ARN-7



Designed primarily to be used as an aircraft-navigational instrument. Basically equip. is a radio receiver using a superheterodyne circuit and certain additional circuits necessary for radio compass operation. Frequency range of 100 kc to 1750 ac covered in four bands.

Consists of Radio Compass Unit, Relay, Indicators, Control Boxes, Loop, Cords and Plugs. **COMPLETE**  
Instruction Charts Furnished. **\$ 125.00**

## ARN-6



General description: Although lighter and more compact than other automatic radio compass equipment, it is one of the most efficient of the airbourne direction finding systems. Frequency: 100 to 1750 kc covered in four bands 100 to 200 kc, 200 to 410 kc, 410 to 850 kc, 850 to 1750 kc. Power: 26.5 V. DC average operation. Limits 21 to 32 V. DC. **COMPLETE \$195.00**

## AN/APR-4



Freq. Range: 38 to 4000 Mc. Covered in 5 tuning unit ranges as follows: TN-16, 38-76 Mc. TN-17: 76-300 Mc. TN-18: 300-1000 Mc. This receiver is a high precision laboratory instrument used to monitor or indicate frequency of any signals within its range. Either pulse or CW type signals. Receiver incorporates a wide and narrow band I.F. strip that can be selected from panel. Outputs are provided for attachments to pulse analyzer, panadapter and various other analyzing instruments. Input: 115V 60 Cyc. Receiver can be supplied with all tuning units, or any tuning units desired, or the tuning units can be supplied separately. Send for technical data sheet **\$ 249.50**

## BC 348

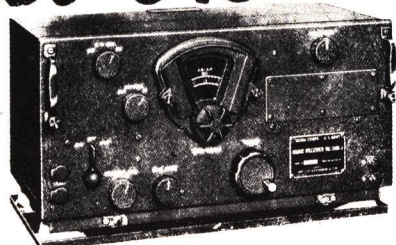

Radio Receiver BC-348 is a locally controlled, eight tube, six band superheterodyne receiver for use in aircraft or marine applications. It covers a frequency range of from 200 to 500 kilocycles and 1.5 to 18 megacycles. The receiver was designed for operation from a 28 volt D.C. source..... **\$ 75.00**

## ARC-27

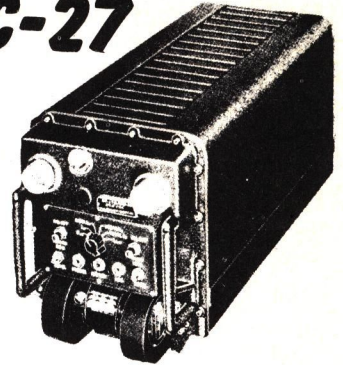

Radio set AN/ARC-27 has been designed to provide AM radio telephone (A-3) communication, in the frequency range of 225.0 to 399.9 megacycles, between aircraft and ship, aircraft and shore, or between aircraft. The transmitter may be tone modulated (A-2) at 1020 cycles per second for emergency or direction finder purposes. Radio Set AN/ARC-27 provides 1750 frequency channels in the above mentioned range. Provisions have been made for the pilot's remote selection of any one of 18 or 20 preset frequencies or operation on a guard channel frequency. Transmission and reception are on the same frequency and by the same antenna. The equipment operates from 27.5 volts DC. Provision is made for ADF operation in conjunction with Direction Finder Group AN/ARA-25.....P.U.R.

## ART-13

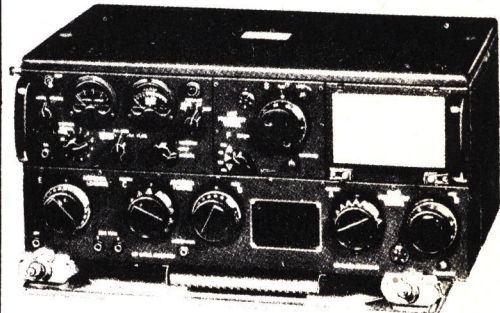

Radio Transmitting Set AN/ART-13-A was designed for installation in aircraft. It is amplitude modulated and operates between the frequencies of 200 to 1500 kilocycles and 2000 to 18,000 kilocycles. Shifting from one frequency to another can be accomplished by the conventional method of "hand positioning" the controls or by using the built-in automatic shifting mechanism known as the "Autotune". Autotune operation is available for eleven pre-selected frequencies, one in the low band and ten in the high band..... **\$ 49.50**

# COLUMBIA ELECTRONIC SALES MAIL ORDER DEPT.

WHOLESALE - RETAIL STORE  
2251 WEST WASHINGTON BLVD.

LOS ANGELES 18, CALIFORNIA • Rpublic 1-2206

OPEN MON. & FRI. TILL 9:00 P.M. - SAT. 9 TO 5:30

SAN FERNANDO VALLEY RETAIL STORE

and WHOLESALE WAREHOUSE  
4900 LANKERSHIM BLVD.

NORTH HOLLYWOOD, CALIFORNIA • Stanley 7-2113 - POplar 6-8668

OPEN 9 TO 9 WEEKDAYS - SAT. 9 TO 6



# COMMUNICATIONS EQUIPMENT

## BC-342

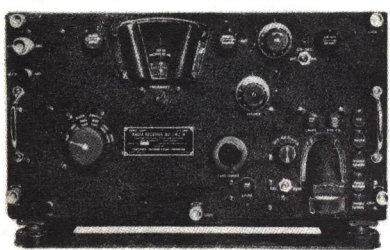

Radio Receiver BC-312 and Radio Receiver BC-342 are of the multi-band, integral-coil, superheterodyne type. Provision is made for the reception of CW, TONE, or VOICE signals. Frequency range of 1500-18000 kilocycles continuously is covered in six bands. BC-312 requires a 12 or 24 volt D.C. source and the BC-342 requires 115 volts A.C. 60 cycles.....

**SPECIAL PRICE \$ 75<sup>00</sup>**

## BC-610-E

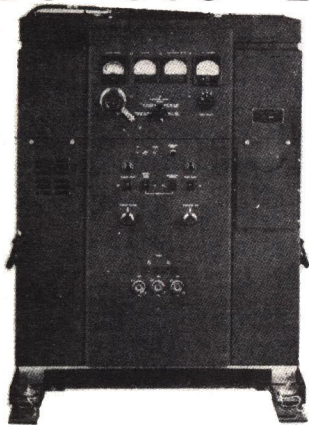

Radio Transmitter BC-610-E is a high powered amplitude modulated, transmitter for use on either M.O. or Crystal, Phone or C.W. It's power output is 400 watts. Power requirements are 115 volts A.C. 60 cycles. Frequency range is 2000 kilocycles to 18000 kilocycles. It is used in the SCR-399, SCR-499, and the AN/GRC-26 Teletype Unit. Specifications on request. **499.50**

## APN-4A

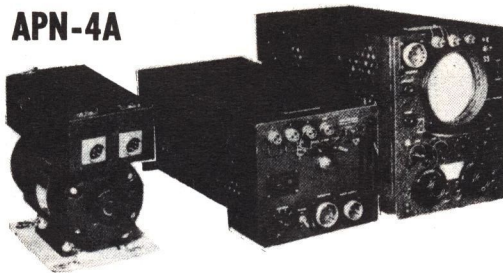

Marine or Airborne long range navigational equipment determines the exact geographical position of your boat or airplane. Geographic positions to J200 miles from any Loran transmitters facility. Complete installation consists of:

**\$95.00**

ID-6A.B/APN-4 Loran indicator uses 5 CPI cathode ray tubes. Easily converted to test oscilloscope, panadapter, analyzer visual, counter, etc. Can build on any scope circuits you can dream up. Contains 22 pots, loads of switches, condensers, transformers, small parts, less small tubes, individually sold. ....PUR

R-9A.B/APN-4: 160 meter Loran receiver plus high voltage for scope and low voltage power supply. Dynamotor delivers 240-275V. continuously variable at 150 ma electronically regulated to plus or minus .01%. Complete installation, weighs less than 199 lbs. with schematic.....PUR

## APR-1 WITH 3 TUNERS

Airborne broadband receiving equipment designed on a unit construction basis allowing IF units power supply and tuning units to be freely interchanged to give the receiver the characteristic of receiving all types of pulse and other signals, designed principally for radar search. Frequency range 40 to 1000 mc covered by 3 interchangeable plug-in type tuning units: Information is presented by either oral mean thru headset or visual means thru cathode-ray indicator.....

**\$75<sup>00</sup>**

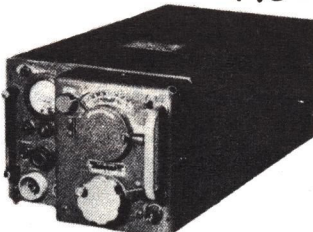

## APN-9

The LORAN system as used in both ships and aircraft provides accurate means of determining position by the reception of radio signals from transmitting stations of known location. Accurate to within 1% of the distance from the ground transmitters. The system operates entirely by radio and does not depend on celestial observations or dead reckoning, and therefore, provides a fix when all other methods of navigation are rendered useless. **75.00**

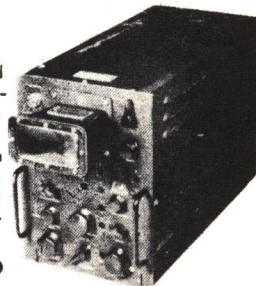

## ARC-1

Units consist of:

**\$ 49<sup>50</sup>**

RT-18 /ARC-1 Transmitter-Receiver  
C-45/ARC-1 Control Unit



Operates from a 24 volt battery supply and provides radio telephone communications in the frequency range of 100 - 156 megacycles between aircraft or aircraft to ground. Provision is made for the remote selection of a two-way operating frequency which may be any one of nine pre-set frequencies in the band or a guard-channel frequency which is fixed within a restricted band

RADIO SET: is an airborne receiving and transmitting equipment designed to provide communications from plane to plane or from plane to ground. Remote operation on eight frequency channels. Transmitter is coordinated with control box and receiver so they both operate in preset frequency channels in combination with other equipment similarly preset. Frequency range 100-156 mc. Operating voltage 22 to 32 DC. Power output 8 watts.

T-67/ARC-3 Transmitter  
R-77/ARC-3 Receiver  
568/ARC-3 Power Junction Box

C-118/ARC-3 Control Box  
and  
Dynamotors-Technical information. P.U.R.

## ARC-3

**\$150<sup>00</sup>**

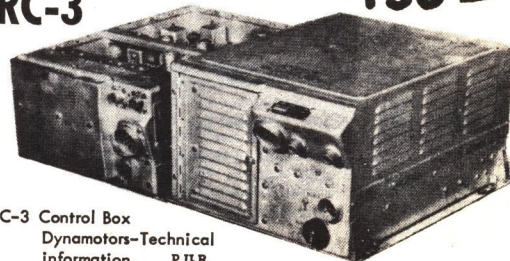

# COLUMBIA ELECTRONIC SALES MAIL ORDER DEPT.

WHOLESALE - RETAIL STORE  
2251 WEST WASHINGTON BLVD.  
LOS ANGELES 18, CALIFORNIA • Republic 1-2206  
OPEN MON. & FRI. TILL 9:00 P.M. - SAT. 9 TO 5:30

SAN FERNANDO VALLEY RETAIL STORE  
and WHOLESALE WAREHOUSE  
4900 LANKERSHIM BLVD.  
NORTH HOLLYWOOD, CALIFORNIA • Stanley 7-2113 - POplar 6-8668  
OPEN 9 TO 9 WEEKDAYS - SAT. 9 TO 6



# COMMUNICATION & NAVIGATION EQUIP.

**ARN-5A**

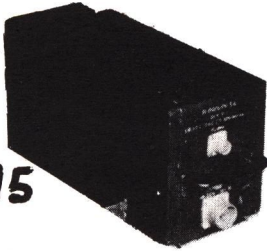

**\$1995**

Airborne equipment designed to give vertical guidance to a pilot during aircraft landings. 11 tube superhetrodyne circuit. 3 crystal control UHF provides static free reception.....

**MN 60**



**\$75.**

This hermetically sealed iron core loop is ideal for all radio compasses. Used on latest jet aircraft as well as commercial aircraft.

**SCR-269 \$75.00 COMPLETE**

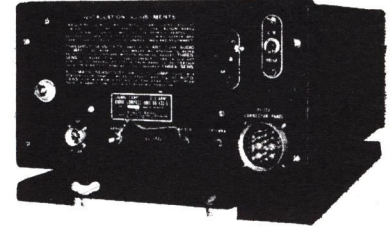

SCR-269 Radio Receiver Compass. Complete set provides automatic bearing indication of direction of radio frequency signals and simultaneous aural reception modulated radio frequency using non-directional antenna. Frequency range 200-1750 kc in 3 bands.

**R8/ARN-8**

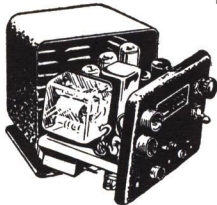

**BEACON RECEIVER 75-Mc.**

Here's a BUY! A 7-tube Beacon Receiver containing the following items: Three 25L6, Two 12SQ7 and Two 12SH7 tubes, a sensitive re-

lay (12,500 ohms) and many other essential parts—completely wired and ready to operate, but less power supply. Housed in a black crackle case approx. 7"x7"x8", complete with shock mounts. This receiver is suitable for remote control service, such as door opening devices, turning lights on and off, starting and stopping motors or machinery from remote points, etc.

**\$8.95**

## AIRCRAFT INSTRUMENTS

Many types far too numerous to mention here. Gyros, airspeed, altimeters, engine instruments, and many others. Write giving details for a return mail quote.



**MN 26 \$49.50 COMPASS RECEIVER**

Remote control commercial type navigational receiver. Indicates direction of any desired transmitting station. 3 bands, frequency range: 150kc to 1500kc. Has 12 - 6 V type tubes.

**24 VOLT DC - INST. ONLY**



**COMPASS BEARING INDICATOR**

Bendix #MN40E. . . Compass Bearing Indicator, part of Radio Direction Finder. Consists of a mechanically driven compass indicator and pointer. Has a worm drive with a gear reduction of 120 to 1 in 360° rotation, which is coupled to a pointer with a 360° dial indicator (1° calibration points). An ingenious built-in mechanical compensator permits correction of deviation over 360°. Equipped with a double ended input shaft which can be coupled with spline fitting or modified to take a 1/4" coupling. Contains two 3 V. Grain of Wheat Bulbs and associated dropping resistor for 28 VDC. operation. Finest construction throughout, with no backlash. Size: 6 dia. x 2 1/2" D. Shpg. Wt., 5 lbs.

**\$1.95**

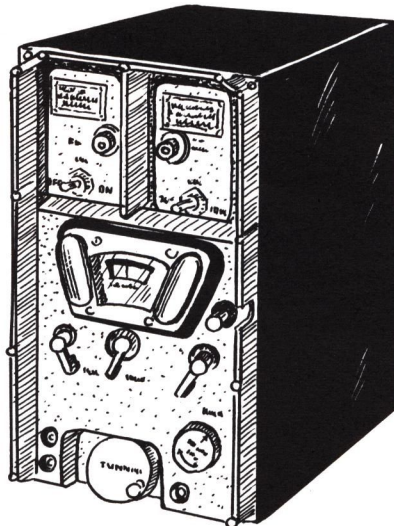

**MARINE COMMUNICATIONS RECEIVER BY GENERAL ELECTRIC MODEL BC-652**

This is a compact 2-6 Mc. 11 tube unit with a built in 12 or 24V.D.C. dynamotor power unit. Compact in size and well built. Ready to install. Specify vantage 12 or 24V.D.C.

Excellent condition units ONLY

**\$14.95**

**BENDIX COASTAL & HIGH SEAS RCVRS & DIRECTION FINDERS**

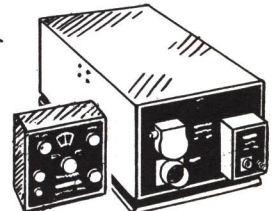

RA-10-DB is like MN-26-C except that indication is by aural null and its tuning ranges are 150-1100 kc DF receiver and 2-10mc receiver only. 47 lb. weight includes receiver with internal 24v dynamotor, MR-9 control box, MN-20 loop, MN - 52 loop control, flex shafts, plugs, and loop transmission line. Draws 3A at 24 V dc. Has built-in relay which connects the loop on the bands 150-1100 kc. **\$47.50**

## COLUMBIA ELECTRONIC SALES MAIL ORDER DEPT.

WHOLESALE - RETAIL STORE  
2251 WEST WASHINGTON BLVD.  
LOS ANGELES 18, CALIFORNIA • REPUBLIC 1-2206  
OPEN MON. & FRI. TILL 9:00 P.M. - SAT. 9 TO 5:30

SAN FERNANDO VALLEY RETAIL STORE  
and WHOLESALE WAREHOUSE  
4900 LANKERSHIM BLVD.  
NORTH HOLLYWOOD, CALIFORNIA • STANLEY 7-2113 - POPLAR 6-8668  
OPEN 9 TO 9 WEEKDAYS - SAT. 9 TO 6



# SURPLUS SELL-SATION BUYS!

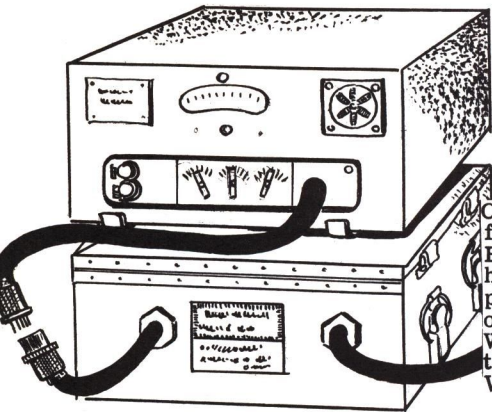

## FM METER \$19.95

Complete transmitter-receiver tuning the frequency range of 27 to 39 Mcs. FM is the BC-659. This unit is crystal controlled and has two channels. This comparatively small package makes for a FB mobile installation or can be converted to the new citizens band. When used with the PE-120 power supply, the BC-659 will operate from 6, 12 or 24 Volts DC.

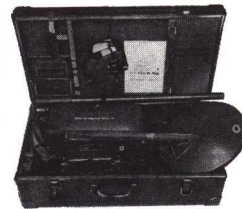

For Prospectors, Miners, Oil Companies, Plumbers, Etc.

### SCR-625 Famous ARMY MINE-DETECTOR

## \$39.95

For Prospectors, Miners, Oil Companies, Plumbers, etc. Portable unit for locating all types of buried metal objects up to 24" or more depending on size and ground condition. Detection by means of a tone. Packed in a chest. Operating weight approx. 15 lbs. Shipping wt. approx. 40 lbs.

### AN/ARC-5 & SCR-274-N EQUIP.

| Receivers |            |  |        |
|-----------|------------|--|--------|
| BC-453    | .19-.55 mc |  | \$9.95 |
| BC-454    | 3-6 mc     |  | 7.95   |
| BC-455    | 6-9.1 mc   |  | 7.95   |
| Broadcast | .55-1.5 mc |  | 29.95  |
| Marine    | 1.5-3 mc   |  | 12.95  |

|        |           |  |      |
|--------|-----------|--|------|
| BC-456 | Modulator |  | 4.95 |
| MD-7   | Modulator |  | 8.95 |

| Transmitters |            |  |       |
|--------------|------------|--|-------|
| BC-457       | 4-5.3 mc   |  | 3.95  |
| BC-458       | 5.3-7 mc   |  | 3.95  |
| BC-459       | 7-9.1 mc   |  | 6.95  |
| T-18         | 2.1-3 mc   |  | 5.95  |
| T-19         | 3-4 mc     |  | 5.95  |
| T-20         | 4-5.3 mc   |  | 3.95  |
| T-21         | 5.3-7 mc   |  | 3.95  |
| T-22         | 7-9.1 mc   |  | 6.95  |
| T-23         | 100-156 mc |  | 12.95 |

| Control Boxes           |                      |      |  |
|-------------------------|----------------------|------|--|
| C-29                    | up to 4 Transmitters | .95  |  |
| C-30                    | For T-23             | 1.95 |  |
| C-39                    | VHF Audio control    | 1.95 |  |
| BC-450                  | 3 Receivers          | 1.00 |  |
| BC-451                  | 1-4 Transmitters     | .95  |  |
| Single Receiver Control |                      | 2.49 |  |
| Dual Receiver Control   |                      | 1.49 |  |

| Racks                   |  |      |  |
|-------------------------|--|------|--|
| Single Receiver Rack    |  | 3.95 |  |
| Dual Receiver Rack      |  | 1.95 |  |
| Triple Receiver Rack    |  | 1.95 |  |
| Single Transmitter Rack |  | 4.95 |  |
| Dual Transmitter Rack   |  | 1.95 |  |

All shockmounts in stock. Please send inquiries. All plugs in stock. Please allow between 75¢ and 1.00 per each. Discounts on complete sets. Your inquiries invited.

|  |      |
|--|------|
| Flex cables all lengths                          | 1.50 |
| MC-211 Angle Adapters                            | 1.00 |
| DM-32 Dynamotors                                 | 1.50 |
| DM-33 Dynamotors                                 | 1.95 |
| BC-442 Antenna Relay unit with Condenser & Meter | 2.95 |



## LARGE POWERFUL BLOWER

115 VOLT  
60 CYC  
\$12.95  
IDEAL FOR COOLING EQUIPMENT ETC.

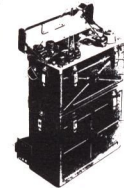

## BC-1000 OR AN/VRC3

40 TO 48 MC  
\$49.50

Radio Set AN/VRC-3 consists of an 18-tube, low power, battery-operated radio receiver and transmitter and accessories. It is designed for frequency-modulated (f-m), two-way communications

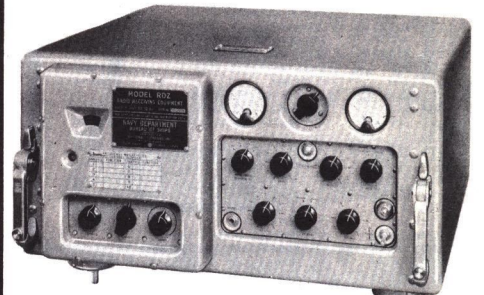

## IDEAL FOR AIRPORT TOWER & MILITARY \$39.95

RDZ RECEIVER

200-400 mc superhet with crystal frequency control. Motor tuning to any one of ten pre-set channels. Self contained 110volt 60 cycle power supply. Complete with all tubes. 150 lbs. Govt. cost approx. \$3500. While they last!

## SCR-522-A

Very-High Frequency Transmitter-Receiver

\$14.95  
COMPLETE WITH TUBES

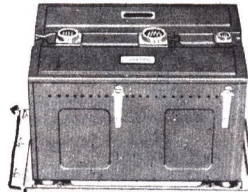

PE 94  
24 VOLT DYN.  
\$2.95

PE 98  
12 VOLT DYN.  
\$12.95

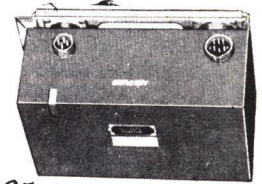

CONTROL BOX \$1.95

ANT. \$1.95

PLUGS \$1.00 EACH

100-156 MC • 4 CHANNELS • CRYSTAL-CONTROLLED AMPLITUDE-MODULATED VOICE RECEIVER AND TRANSMITTER

# COLUMBIA ELECTRONIC SALES MAIL ORDER DEPT.

WHOLESALE - RETAIL STORE  
2251 WEST WASHINGTON BLVD.

LOS ANGELES 18, CALIFORNIA • RPublic 1-2206

OPEN MON. & FRI. TILL 9:00 P.M. - SAT. 9 TO 5:30

SAN FERNANDO VALLEY RETAIL STORE  
and WHOLESALE WAREHOUSE

4900 LANKERSHIM BLVD.

NORTH HOLLYWOOD, CALIFORNIA • Stanley 7-2113 - POplar 6-8668

OPEN 9 TO 9 WEEKDAYS - SAT. 9 TO 6



**LARGEST  
ASSORTMENT  
FINEST QUALITY**

# TEST EQUIPMENT

Please write us your requirements so we may quote you our low current prices.

- |               |                               |                     |
|---------------|-------------------------------|---------------------|
| TS-7 ASQ      | Magnetic compensator          |                     |
| TS-10 APN     | Altimeter test set            | Delay line          |
| TS-12 AP      | Standing wave ind.            | X-band VSWR         |
| TS-13 AP      | Sig. gen. freq. mtr           | X-band              |
| TS-14 AP      | Sig. gen. pwr mtr             | S-band              |
| TS-15 AP      | Fluxmeter                     | 1.2-4.5K GAUSS      |
| TS-16 APN     | Altimeter test set            | 340-7250 CYC        |
| TS-18 AP      | Voltage divider               | 100 : 1-15 : 1      |
| TS-19 APQ-5   | Calibrator                    | 491.04 MC           |
| TS-23 APN     | Altimeter test set            |                     |
| TS-24 ARR-2   | Test oscillator               | 246 MC              |
| TS-27 TSM     | Line test set                 | 0-50 MEG., 1-3 MFD  |
| TS-28 APN     | Synchroscope                  |                     |
| TS-32 TRC-1   | Test oscillator               | 1 KC FM, 70-100 MC  |
| TS-33 AP      | Frequency meter               |                     |
| TS-34 AP      | Portable oscilloscope         | Fast sweep          |
| TS-35 AP      | Sig. gen. pwr and freq. mtr   | X-band              |
| TS-36 AP      | Power meter                   | X-band              |
| TS-45 APM-3   | Power and freq. meter         | X-band              |
| TS-46 AP      | Frequency meter               | S-band              |
| TS-47 APR     | Signal generator              | 40-500 MC           |
| TS-51 APG-4   | Goniometer                    |                     |
| TS-56 AP      | Standing wave ind.            | L-band              |
| TS-59 APN     | Delay line altimeter          | High alt            |
| TS-61 AP      | Echo box                      | S-band              |
| TS-62 AP      | Echo box                      | X-band              |
| TS-67 ARN-5   | U/with RC103/ARN5             |                     |
| TS-69 APR     | Calibrator freq. meter        | .4-1KMC             |
| TS-74 UPM     | Attenuator and phantom ant.   | S-band              |
| TS-75 U       | Test meter                    | U/with TS76         |
| TS-76 APM-3   | Wave guide kit                | U/with TS45         |
| TS-78 U       | Phantom antenna               | 100-156 MC          |
| TS-89 AP      | Voltage divider               | X-and S bands       |
| TS-91 TPS-1   | Echo box                      | 1050-1110 MC        |
| TS-92 AP      | Broad band alignment          | 20-250 MC           |
| TS-98 AP      | Decade resistor               | 22.85 : 1           |
| TS-100 AP     | Oscilloscope circular sweep   |                     |
| TS-102 AP     | Range calibrator              | Sine wave 327.8 KC  |
| TS-108 AP     | RF dummy load                 | X-band              |
| TS-110 AP     | Echo box                      | S-band              |
| TS-111 CP     | Wavemeter                     | S-band              |
| TS-117 GP     | Wavemeter, absorption         | S-band              |
| TS-118 AP     | Wavemeter                     | 20-1000 MC, 1-500 W |
| TS-120 UP     | Sig. gen. pwr meter           | X-band              |
| TS-125 AP     | Power meter                   | S-band              |
| TS-126 AP     | Radar range calibrator        | 400 YD. PIPS        |
| TS-127 U      | Frequency meter               | 375-725 MC          |
| TS-131 AP     | Field strength meter          | 20-3000 MC          |
| TS-133 UPM-1  | Wavemeter                     | 115-235 MC          |
| TS-134 UPM-1  | Wavemeter                     | 460-570 MC          |
| TS-137 AP     | FM Sig. gen. wave and pwr mtr | X-band              |
| TS-147 UP     | Sig. gen. pwr freq. meter     | X-band              |
| TS-148 UP     | Spectrum analyzer             | X-band              |
| TS-155 UP     | Pulse generator               | S-band              |
| TS-159 TPX    | Sig. gen. pwr freq. mtr       | 150-200 MC          |
| TS-170 ARN-5  | Test oscillator               | 332.6-335 MC        |
| TS-173 UR     | Frequency meter               | 90-450 MC           |
| TS-174 U      | Frequency calibrator          | 20-250 MC           |
| TS-175 U      | Frequency calibrator          | 85-1000 MC          |
| TS-182 UP     | Signal generator              | 157-187 MC          |
| TS-184 AP     | Echo box                      | 400-430 MC          |
| TS-192 CPM-4  | Wavemeter                     | S-band              |
| TS-204 AP     | Reflectometer                 |                     |
| TS-218 UP     | Tuned cavity                  | X-band              |
| TS-225 AP     | Wavemeter to K KW             | 400-425 MC          |
| TS-247 APM-48 | Wavemeter                     | 215-275 MC          |
| TS-250 APN    | Altimeter calibrator          | Delay line          |
| TS-251 UP     | Loran sig. generator          | 1700-2010 KC        |
| TS-258 UP     | Sig. gen. pwr and freq. mtr   | X-band              |
| TS-259 AP     | FM signal generator           |                     |
| TS-263 TPS-10 | Sig. gen. wavimeter           | X-band              |
| TS-268 U      | Xtal rect. test set           |                     |
| TS-270 UP     | Echo box                      | S-band              |
| TS-278 AP     | Test set                      | 400-420 MC          |
| TS-297 U      | Multimeter                    |                     |
| TS-309 U      | Sweep generator               | 5-65 MC             |
| TS-323 UR     | Frequency meter               |                     |
| TS-352 U      | Multimeter                    |                     |
| TS-375 U      | Voltmeter                     |                     |
| TS-382 U      | Audio oscillator              | 1000 KC             |
| TS-505        | Vac. tube voltmeter           |                     |
| I-48          | Megohmmeter                   | 0-1000 MEG          |
| I-49          | Wheatstone bridge             | 0-10 MEG            |
| I-56          | Tube tester voltohmmeter      |                     |
| I-72          | Signal generator              | 100 KC-32 MC        |
| I-83          | Dynamometer test set          |                     |
| I-86          | Generator                     | 470 MC              |
| I-96 A        | Signal generator              | 100-156 MC          |
| I-100         | Radio ADF test set            |                     |
| I-130 A       | Signal generator              | 100-156 MC          |
| I-203 A       | Bolometer                     | S-band              |
| I-208         | Signal generator              | 1.9-45 MC           |
| I-222 A       | Signal generator              | 8-230 MC            |
| IE-17         | Handy talky test set          |                     |
| IE-19         | SCRS22 test set               | 100-156 MC          |
| IE-36         | SCRS22 test set               |                     |
| IE-46         | IFF test set                  | 156-166 MC          |
| IE-56         | IFF test set                  | 166-186 MC          |
| BC-221        | Frequency meter               | 125-20000 KC        |
| BC-376        | Signal generator              | 75 MC               |
| BC-1066       | Test receiver                 | 150-225 MC          |
| BC-1077       | Signal generator              | S-band              |
| BC-1203       | Modulator unit                |                     |

## TS-102/AP

**\$22<sup>50</sup>**



TS-102/AP Range Calibrator, this crystal controlled pulse generator produces a square-topped, 50 volt synchronizing pulse of .8 microseconds at a prf of 400, 800, 1600 or 2000 cps. and a triangular marker pulse of 0.4 microseconds duration at a prf corresponding to a pulse-echo distance of 1500 ft. The phase between the marker and sync. pulses is continuously variable from -180 to +180 degrees.

## STANDARD SIGNAL GENERATOR

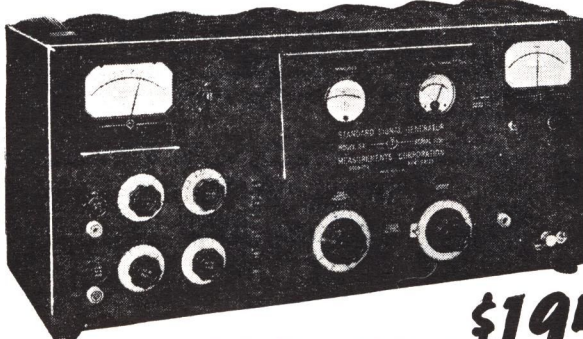

**\$195<sup>00</sup>**

Model 84 • 300 MC. - 1000 Mc.

**SPECIFICATIONS**  
 FREQUENCY RANGE: 300 to 1000 megacycles in one band; individually calibrated direct reading dial.  
 FREQUENCY ACCURACY: ±0.5%.  
 OUTPUT VOLTAGE: Continuously variable from 0.1 to 100,000 microvolts.  
 OUTPUT IMPEDANCE: 50 ohms.  
 MODULATION: 0 to 30% within ±20% as determined by DC meter. Internal sine-wave oscillator; choice of 400, 1000, or 2500 cycles is provided. External modulation up to 30 kilocycles may be applied.  
 PULSE FREQUENCY: 60 to 100 Kc in three ranges, 60-1000, 600-10,000 and 6000-100,000 pulses per second.  
 POWER SUPPLY: 117 volts, 50 to 60 cycles.  
 DIMENSIONS: 13" high x 26" wide x 12 1/8" deep, overall.  
 WEIGHT: Approximately 135 pounds, including external line voltage regulator.

## GRIPROBE

the test-probe that frees your hands

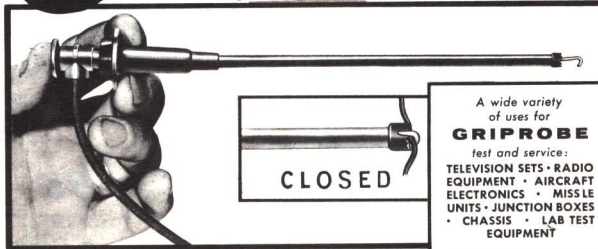

Grips and holds terminals, resistors, wires, etc. Leaves both hands free to adjust scope, VTVM, Audio Oscillator Opens and Closes by THUMB action alone 5 Foot test lead wire Made of durable vinyl plastic

**2 FOR \$1.00 59c**

## HETERODYNE FREQUENCY METERS

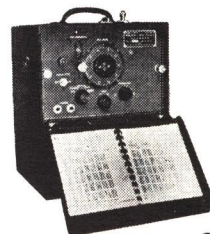

**BC-221 \$59.50**

FREQUENCY METER  
 Freq. Range: 125 to 20,000KC.  
 Osc. Fund. Range: 125 to 250KC and 2000 to 4000KC  
 Accur: 0.01% or ± 500 cy.  
 Audio Modulation: Not provided

**BC-221 with Modulation-Same as above but with Audio Modulation \$79.50**

## TS-175/U FREQUENCY METER

Freq. Range: 65 to 1000 MC  
 Osc. Fund. Range: 85 to 200 MC  
 Accuracy: 0.05%  
 Sensitivity: 20 MV to 2 V.  
 Output: 100 UV to 20 MV.  
 Audio Modulation: 1000 Cy.  
**\$175.00**

## TS-174/U FREQUENCY METER

Freq. Range: 20 to 260 MC.  
 Osc. Fund. Range: 20 to 40 MC.  
 Accuracy: 0.05%  
 Sensitivity: 20 MV. to 2 V.  
 Output: 50 UV. to 20 MV.  
 Audio Modulation: 1000 cy.  
**\$99.50**

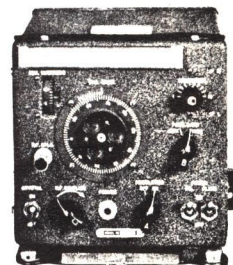

## LM FREQUENCY METER

U.S. Navy version of the famous Signal Corps Type BC-221 Frequency Meter.  
 Frequency range- 125 to 20,000 KC  
 Accuracy 125 to 2000 KC 0.02%.  
 2 to 20 Mc 0.01%  
 Built-in audio modulation. Includes tubes, crystal and original calibration book.

**\$49.50**

Each unit completely reconditioned and tested prior to shipment.

# COLUMBIA ELECTRONIC SALES MAIL ORDER DEPT.

WHOLESALE - RETAIL STORE  
 2251 WEST WASHINGTON BLVD.  
 LOS ANGELES 18, CALIFORNIA • Republic 1-2206  
 OPEN MON. & FRI. TILL 9:00 P.M. - SAT. 9 TO 5:30

SAN FERNANDO VALLEY RETAIL STORE  
 and WHOLESALE WAREHOUSE  
 4900 LANKERSHIM BLVD.  
 NORTH HOLLYWOOD, CALIFORNIA • Stanley 7-2113 - POplar 6-8668  
 OPEN 9 TO 9 WEEKDAYS - SAT. 9 TO 6



# BUY RETAIL at WHOLESALE PRICES!

## MASTER

For 6 volt battery—output 40 to 50 watts. For 12 volt battery output 50 to 60 watts. Size, 4"x5"x6". Operates all Equipment same as smaller models, plus Wire Recorders, small drills, etc.

LIST PRICE ~~\$39.50~~ **\$25.97**  
OUR PRICE .....



## SENIOR

For 6 volt battery—output 35 to 40 watts. For 12 volt battery—output 40 to 50 watts. Extensively used to operate Dictating Machines, Shavers, Phonographs, Radios, Lights, etc.

LIST PRICE ~~\$21.95~~ **\$14.63**  
OUR PRICE .....



## AUTOMATIC

No switches to throw. No vibrators to turn. No installation! Just plug into either 6 or 12 volt cigar lighter. Operates from either 6 or 12 volt battery. With 6 volt battery—output 55 to 75 watts. With 12 volt battery output 85 to 110 watts. Operates same equipment as Super Model.

LIST PRICE ~~54.45~~ **\$36.63**  
OUR PRICE .....



Enjoy —one of the greatest conveniences of this Electronic Age

THE CONVENIENCES AND PLEASURE OF:

- Portable TV.
- Tape Recorders
- Small Elec. Tools
- Dictating Machines

- {Yes -- Anywhere you drive in car, truck, boat, plane
- Electric Shavers
  - Lights - Radios
  - Etc., etc., etc.
  - Phonographs

## SUPER

For 6 volt battery—output 35 to 40 watts. For 12 volt battery—output 75 to 100 watts. Operates portable TV, small Do-It-Yourself tools, Address Systems, etc., etc.

LIST PRICE ~~\$46.95~~ **\$31.30**  
OUR PRICE .....



## CHIEF

One of the most popular Models. For 6 volt battery—output 75 to 100 watts. For 12 volt battery—output 100 watts. Has automatic cut-off switch. Operates all equipment, previously listed, plus Amplifiers, etc. "101" Uses.

LIST PRICE ~~\$69.95~~ **\$43.30**  
OUR PRICE .....



## PORTABLE LIGHTS & EXTENSION CORDS

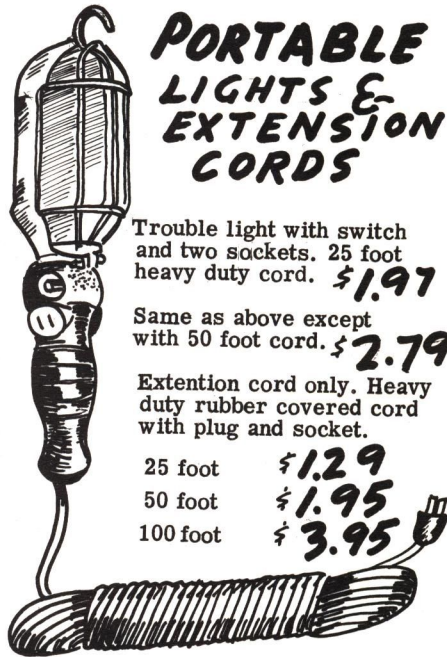

Trouble light with switch and two sockets. 25 foot heavy duty cord. **\$1.97**

Same as above except with 50 foot cord. **\$2.79**

Extension cord only. Heavy duty rubber covered cord with plug and socket.

25 foot **\$1.29**  
50 foot **\$1.95**  
100 foot **\$3.95**

## COLUMBIA SELLS FOR LESS • ORDER NOW WHILE THE SUPPLY LAST

### MINIATURE "OUNCER" AUDIO TRANSFORMER



This half-pint size UTC audio ouncer has terrific promise for any of you with a little bit of ingenuity. Unit has two center tapped secondary windings which permits any combination of impedances for almost any use. We have tried them out for the following uses and found them to be excellent: Mike Input, LO-Level output to line (balanced or unbalanced), Interstage Transistor Coupling, Tone Generator for Test Equipment, Organs, and etc., Blocking Oscillator, Phase Detection (lower frequencies). As stated before, the advantages and possibilities of two center tapped windings are limited only by the experimenter's ability and ingenuity, AND JUST LOOK AT THIS LOW PRICE OF **59c ea.**



### DELUXE METAL CABINET

Manufactured for late model teletype perforator. Ideal for use for, Amplifier, Tuner, Communications Receiver, and etc. Grey crackle finish has self locking front lid and open-up back lid. Original cost to local manufacturer \$28.00, these are brand new in original factory wrapping and not G.I. surplus..... each **\$295**



### AIR FORCE HAND MICROPHONE

USAF type. Highly sensitive. Has thumb control button in handle. Ideal for recording, public address systems, etc. Comes with 2 ft. rubber cord and phone plug. **NEW \$7.95 USE 3.95**

### COLUMBIA'S PHONE PATCH KIT

This is a Phone Patch the likes of which is hard to find. Perfect impedance matching makes this the finest yet. We do not want to start in the manufacture of these units as we feel you can do as good a job if not better, and save the labor costs. All of the components supplied are brand new stock at surplus prices. Everything is miniaturized and compact. Complete schematic simplified so that even the newest novice can wire this unit up. Parts alone valued at \$9.75 distributors net: Get yours now!..... **\$395**

### LORAN APN/4 OSCILLOSCOPE

Easily converted for use on radio-TV service bench. **Completely Assembled LESS TUBES \$9.88**



CONTROL BOX AND PLUGS **\$4.95 SET**

### MODEL ARB COMMUNICATIONS RECEIVER

Six tube superhetrodyne remote controlled receiver, tunes 195 KC thru 9050 KC. Includes Lighthouse, Aircraft Radio Ranges, Weather Reports, Complete Broadcast Band, Police Calls, All Marine Frequencies, Amateur 160 meter, 80 meter, 75 meter and 40 meter bands. Very sensitive includes RF stage. Sharp and broad selectivity. Has output to power DU-1 loop antenna. AVC-MVC switching. BFO on-off switch. Ideal receiver for Marine, Amateur, Aircraft, or Emergency Mobile. Air contained 24V dynamotor. Easily converted to 12V operation by simply changing dynamotor and paralleling filaments, or by replacing dynamotor with an A.C. supply, to a fine quality home receiver. With all tubes and 24V dynamotor. Excellent Condition. Schematics on request with order. **\$14.95**



### AIR FORCE TYPE T-30 THROAT MICROPHONE

Genuine USAF, Type T-30 Gives distinct voice reproduction for most uses. 2 microphones mounted in rubber neckpiece with elastic neckband. Operates between 100 & 300 ohms. **69¢**

### BC-1033 MARKER BEACON RECEIVER

75 Mc. Three tube, tuned RF, reflex type receiver with a rectified output operates extremely sensitive relays in audio control work. Relay closes at 0.4 Ma., re-opens when the current falls to 0.2 Ma. Contacts will carry 500 Milliamp current at low voltages. Excellent basis for door opener, robot audio control of model planes and boats, etc., Converts to tone keyer for transmitter monitors..... **\$495**

### COAXIAL CONNECTOR BARGAINS



PL-259 or 831SP 20c. Each  
PL-258 or 831J 50c. Each  
M-355 or 831AP 20c. Each  
SO-239 or 831R 20c. Each  
Quantity is limited to order yours now. All 20c. connectors are 8 for \$1.50. The PL-258 Adapters are 10 for \$4.50. **EXC. USED**

### TWO METER ARC-5 TRANSMITTER

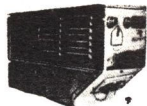

Ideal transmitter for Mobile, C.A.P., Two Meters, Fire Dept., Sheriffs Frequencies, and especially swell for novice. Incorporated turret switching coils for all stages. Use 1625 osc., 1625 Tripler, 832-A Tripler, 832-A Final. Frequency Range is 100 MC thru 156 MC. Four channels are provided using four separate coils in an automatic turret using 12 or 24V motor or a manually operated system. These coils can easily be re-wound for six meters. Complete with all tubes and schematic, these units are in excellent condition **\$1295** for only .....



### SIGNAL CORPS CARBON TYPE DESK MICROPHONE

**\$2.95**

Used by radio "hams" & professional recording studios, broadcasting, public address, etc. Telephone type with sensitive, clear tone. Developed for the U.S. Signal Corps. Complete with cord and plug.



### REAL BARGAIN

#### SURPRISE...SURPRISE...SURPRISE

20 Pounds of BRAND NEW Electronic items. No Crud! No Junk! No disappointments when you receive this latest Surprise Package of ours. We could almost guarantee complete satisfaction, except some guys expect to get 200.00 worth of gear for 3.50. However, we will say this. YOU CAN NOT BUY ANYWHERE IN THE WORLD CLEANER MERCHANDISE OR A BETTER ASSORTMENT OF ELECTRONIC COMPONENTS AT A LOWER PRICE. This statement we absolutely guarantee. Weights may vary from 19 to 20 lbs. But be assured that the values are there. This assortment of BRAND NEW components, includes, Transformers, Choke, Tubes, Resistors, Capacitors, Volume Controls, Insulators, Test Leads, Tube Sockets and much more. Get yours while they last..... **\$350**

# COLUMBIA ELECTRONIC SALES MAIL ORDER DEPT.

WHOLESALE - RETAIL STORE  
2251 WEST WASHINGTON BLVD.

LOS ANGELES 18, CALIFORNIA • Republic 1-2206

OPEN MON. & FRI. TILL 9:00 P.M. - SAT. 9 TO 5:30

SAN FERNANDO VALLEY RETAIL STORE  
and WHOLESALE WAREHOUSE

4900 LANKERSHIM BLVD.

NORTH HOLLYWOOD, CALIFORNIA • STANley 7-2113 - POplar 6-8668

OPEN 9 TO 9 WEEKDAYS - SAT. 9 TO 6



# Columbia BRINGS YOU THE LOWEST PRICES EVER!

## BC 603 AC POWER PACK BC 683

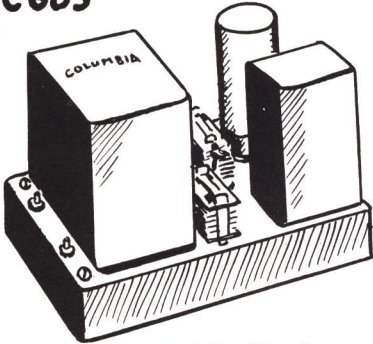

Newly manufactured for the above mentioned FM receivers. It is designed to plug into the space provided for the dynamotor. **THERE IS ABSOLUTELY NO CONVERSION NECESSARY** with the use of this power pack. Especially designed to make it possible to use the incorporated squelch circuit in the receiver.

KIT FORM...\$ 7.95

**ASSEMBLED \$11.95**

Behind-the-panel mount round tuning indicator. Face illuminated by grain of wheat lamp. Full scale is 5 ma dc which is standard for most "S" meter circuits. 2 3/8" across the face, reverse-set, pointer. Excellent condition. With the 3 volt lamp and schematic. Shpg wt 1 lb.



**\$1.50**



### U.S. NAVY HAND MICROPHONE

Made for the Navy to highest Gov't spec's. Has bakelite case with push-button control. Comes with a 4 ft. rubber covered cord and jack.

**ONLY \$2.50**

### TUNER CHASSIS

Local tuner manufacturer changes models and we got the old chassis. This TV tuner chassis makes a fb chassis for preamp, Code Oscillator, small power supply, etc. All pre-punched and ready for mounting of parts and tubes

**3 for 25c ONLY**

**Real Bargains**

### 1020 CYCLE FILTER

Commonly known as poor man's Q 5er. Terrific for listening on on CW overcrowded bands. Used good condition .....

**49c**

### KNOB ASSORTMENT

Don't spend your valuable time unnecessarily looking for a knob when you need it. We have packaged all assortment that will probably fill any of your future or present needs. All brand new push-ons, set screw type, pointer type, round, etc. a complete assortment

**\$1.00**

### MINIATURE I.F. TRANSFORMER

Fully shielded 455 KC I.F. transformer for use on Broadcast Band and Communications Receivers. Small size permits designing of small size communications receiver or portable broadcast band receiver. Size 3/4" x 3/4" x 1 1/2" High, Brand new condition ...

**3 for 50c**

### TERMINAL BOARDS

10 ASSORTED ONLY **49c**  
Always needed in wiring various assemblies. Practically Any One is ment of Ten.

# GAS GENERATORS POWER PLANTS

EAST & MID WEST F.O.B. BURINGTON WIS.  
WEST F.O.B. LOS ANGELES

**ELECTRIC START ADD \$35.00**

**\$199.50**

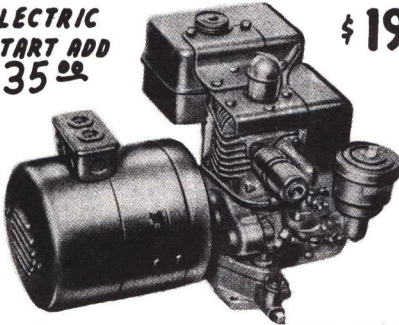

MODEL PP 12 1200 Watts

- WINDINGS** - Field coils and armature are designed with extra heavy windings for generous overload allowance.
- FRAME** - Cast steel. Special streamlined design provides space for large pole pieces and field coils, and yet occupies minimum space.
- INSTRUMENTS** - Built in control box contains convenient duplex power receptacle for easy distribution of current. No wiring is required. Simply plug in and operate.
- DRIVE** - Generator is integrally coupled with engine and driven directly by the engine shaft. Drive is self aligning and permanent. This type of drive offers the advantages of occupying a minimum of space, freedom from belt maintenance and replacement, and 100% efficiency of power transmission.
- ENGINE** - 4 cycle, single cylinder, air-cooled, heavy duty manufactured by Briggs & Stratton. Service and parts available all over the world. Bore 2 1/2". Stroke 2". Piston displacement 1.85 cubic inches.
- Horsepower** - 2.75 H.P. at 3600 RPM.
- Piston** - Aluminum alloy with 2 compression rings and 1 oil control ring.
- Cylinder Head** - Aluminum with large cooling area.
- Cylinder and Crank Case** - Close grained, precision machined of special cylinder alloy.
- Ignition** - High tension magneto with permanent alnico magnets. Molded waterproof coil. Ignition system radio shielded. Spark plug size 14 mm. Hot spark assures easy starting.
- Lubrication** - Positive splash system.

NET WEIGHT: 90 lbs.  
DOMESTIC SHIPPING WEIGHT: 100 lbs.  
EXPORT SHIPPING WEIGHT: 130 lbs.

EXPORT DIMENSIONS: 25"x20"x20".  
DIMENSIONS OF PLANT INSTALLED:  
18"x17"x17".

### Specifications

- OUTPUT** 1250 watts maximum duty 1000 watts continuous 115/130 volt, 60 cycle, single phase. A.C. 6 or 12 volt D.C. (as specified), 180 watts for battery charging.
- GENERATOR** - 2 pole, with built in exciter, 3600 RPM.
- GENERATOR BEARINGS** - Heavy duty ball bearings sealed and prelubricated for life.
- ARMATURE** - Dynamically and statically balanced, ventilated construction - heavy windings - 2 collector rings providing 2-wire, 115/130 v. output
- REGULATION** - Inherent through special balanced design of windings.
- SPEED** - Automatically fixed and maintained by precision mechanical fly-ball governor on engine.

### Specifications

- OUTPUT** - 500 watts continuous duty, 115 volts D. C.
- GENERATOR** - 2 pole, 2400 RPM.
- GENERATOR BEARINGS** - Heavy duty ball bearings, sealed and prelubricated for life.
- ARMATURE** - Dynamically and statically balanced, ventilated construction, heavy windings - 2 brushes providing 2-wire 115 volt D.C. output.
- REGULATION** - Inherent through special balanced design of windings.
- SPEED** - Automatically fixed and maintained by precision mechanical flyball governor on engine.
- WINDINGS** - Field coils and armature are designed with extra heavy windings for generous overload allowance.

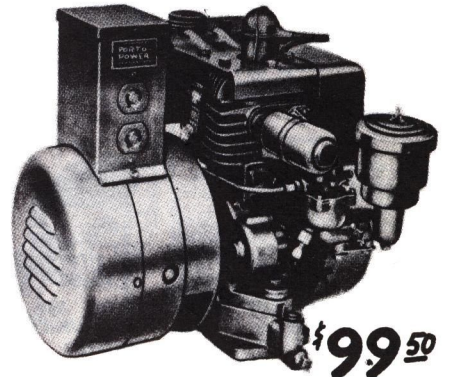

MODEL PP 5DC 500 Watts

- FRAME** - Cast steel. Special streamlined design provides space for large pole pieces and field coils, and yet occupies minimum space.
- INSTRUMENTS** - Built-in power distribution box contains duplex power receptacle from which 115 volt D.C. power is distributed. Box also contains condensers and filters which afford exceptionally good radio shielding.
- DRIVE** - Generator is integrally coupled with engine and driven directly by the engine shaft. Drive is self aligning and permanent. This type of drive offers the advantages of occupying a minimum of space, freedom from belt maintenance and replacement, and 100% efficiency of power transmission.
- ENGINE** - 4 cycle, single cylinder, air-cooled, heavy duty, manufactured by Briggs & Stratton. Service and parts available all over the world. Bore 2". Stroke 2". Piston displacement 1.28 cubic inches. Horsepower 2 H.P. at 3600 RPM.
- Piston** - aluminum alloy with two compression rings and one oil control ring.
- Cylinder Head** - aluminum with large cooling area.
- Cylinder and Crankcase** - Close grained, precision machined of special cylinder alloy.
- Ignition** - High tension magneto with permanent alnico magnets. Molded waterproof coil. Ignition system radio shielded. Spark plug size 14 mm. Hot spark assures easy starting.
- Lubrication** - Positive splash system.
- NET WEIGHT OF PLANT:** 65 lbs.
- DOMESTIC SHIPPING WEIGHT:** 75 lbs.
- EXPORT SHIPPING WEIGHT:** 90 lbs.

- Main Bearings** - Two Shielded ball bearings.
- Crankshaft** - Alloy steel forging, heat treated and counter-balanced.
- Valves** - Austenitic steel exhaust valves.
- Air Cleaner** - Heavy duty oil bath type.
- Fuel Filter** - Fuel filter and sediment sump in tank.
- Crankcase Capacity** - 1 pint oil.
- Fuel Tank** - 2 quart capacity.
- Fuel** - 65-85 octane gasoline.
- Starting** - Rope start.
- EXPORT DIMENSIONS:** 19"x20"x18".
- DIMENSIONS OF PLANT INSTALLED:** 15"x15"x14" high.



SOUND TRUCK



STANDBY



CIVIL DEFENSE

# COLUMBIA ELECTRONIC SALES MAIL ORDER DEPT.

WHOLESALE - RETAIL STORE  
2251 WEST WASHINGTON BLVD.  
LOS ANGELES 18, CALIFORNIA • Republic 1-2206  
OPEN MON. & FRI. TILL 9:00 P.M. - SAT. 9 TO 5:30

SAN FERNANDO VALLEY RETAIL STORE  
and WHOLESALE WAREHOUSE  
4900 LANKERSHIM BLVD.  
NORTH HOLLYWOOD, CALIFORNIA • Stanley 7-2113 - POplar 6-8668  
OPEN 9 TO 9 WEEKDAYS - SAT. 9 TO 6



# TABLE RADIOS • APPLIANCES

## GRANCO HIGH FIDELITY TABLE RADIOS...WITH FM

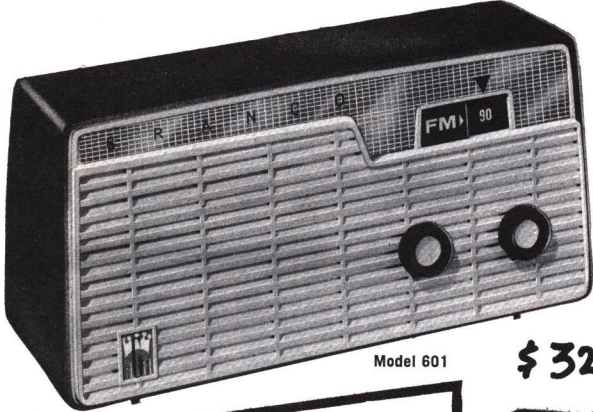

Model 601

**Model 601 FM Radio**  
America's best buy in an FM radio! The "Music Hall" offers exceptionally fine static-free FM reception... adds stereophonic sound to your present radio! Exclusive Royal "G" coaxial tuning for drift-free performance, easy-view window dial, vernier tuning, built-in antenna. AC-DC. Smartly styled cabinet encases set on all sides, including back. In choice of decorator colors with white mist grille. 9½" wide, 4" deep, 5" high.

**\$29.95**

**\$32.95 IN CORAL & TURQ.**

## PACKARD BELL RADIOS FOR POWER • PLEASURE • PERFORMANCE

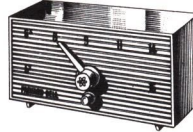

**AM Radios \$14.85**  
IN EBONY

PINK • WHITE  
NOMAD YELLOW • TURQ \$15.85

**SPECIAL MODEL 5R-5:** Powerful 5-tube performance, superheterodyne chassis; decorator colors.



IN COLORS \$26.95  
AS ABOVE

**AM Clock Radios**  
IN EBONY \$24.95

**SPECIAL MODEL SRC-3:** A perfect way to start the day and to keep abreast of the times. De luxe Telechron clock and 5-tube AM radio combine to waken you pleasantly...and on time! Decorator colors.

**DECORATOR MODEL SRC-1:** New twin-tone clock radio lulls you to sleep with music, wakens you with song or a buzzer alarm. Two dynamic speakers, 6-tube chassis, de luxe Telechron clock, timed appliance outlet and decorator colors! \$47.95 EBONY \$49.95 COLORS

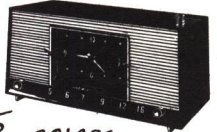

## GE CLOCK-RADIO

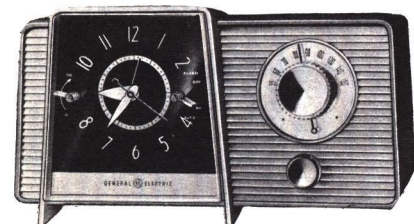

GENERAL ELECTRIC

- Automatic wake-to-music and/or buzzer
- Slumber switch turns radio off at night
- Cabinet fully molded front and back
- Lever type controls; luminous hands on clock

ASS. COLORS **\$29.95**

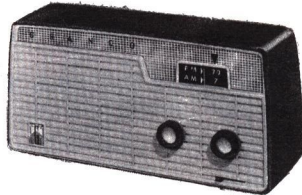

**Model 701 FM-AM Radio**  
Engineered for complete radio reception - FM and AM. Revolutionary new Royal "G" coaxial tuning assures drift-free reception. High sensitivity and selectivity. Extended range speaker. Powerful 6-tube (plus rectifier) chassis provides 8-tube performance by use of multiple purpose tubes. Built-in antennas. AC-DC. Smart cabinet encases set on all sides, including back. In choice of decorator colors with white mist grille. 9½" wide, 4" deep, 5" high.

**DRIFT FREE RECEPTION**  
**\$39.95** GREY  
**\$42.95** IN CORAL & TURQ.

## UNIVERSAL



AUTOMATIC  
**STEAM 'N DRY IRON**

The quick action "jiffy switch" to give you instant control. The ease of filling and emptying through the Easy Fill opening in the handle. The rounded heel and all round bevel for getting into corners and under buttons. The larger capacity and soleplate area that makes work go faster. And finally the extra convenience of the reversible cord.

**\$10.88**

## AMERICA'S FAVORITE COFFEEMAKER



Your Universal Coffeemaking is designed to make the best coffee you ever tasted... and with the least possible fuss or bother. It's a time-saver, too, because it's completely automatic... needs no watching... tells you when your coffee is ready to serve. 8-cup chrome Coffeemaking, and CORD Alternating Current only, 110-120 volts.

**18.95**

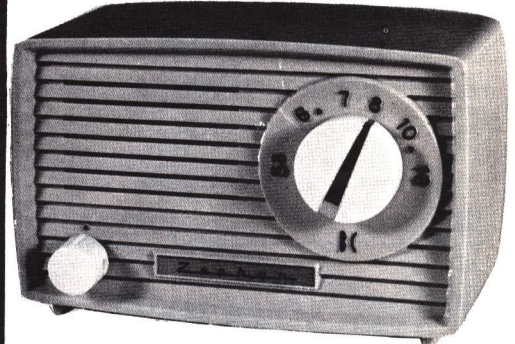

**Zephyr** MODEL 5TM2

Beauty of appearance and beauty of performance are built-in characteristics of this — the smallest 5 tube radio available today.

Superheterodyne chassis gives highest quality reception. Requires no outside antenna or ground. Handsomely styled to harmonize with any decor. Smallest five tube radio available. Only 3¼" x 6¾" x 4". Four glowing decorator colors

BLUE YELLOW SOFT GREEN & ROSE

**\$12.95**

## DORMEYER AUTOMATIC ELECTRIC SKILLET



**\$18.95**  
WITH COVER

THERMOSTATICALLY CONTROLLED

Temperature settings are dependable because thermostat control is in center of pan. Tubular heating element won't burn out ever. Uniform heating surface prevents scorching. 110-120 volts, AC.

# COLUMBIA ELECTRONIC SALES MAIL ORDER DEPT.

WHOLESALE - RETAIL STORE  
2251 WEST WASHINGTON BLVD.

LOS ANGELES 18, CALIFORNIA • REpublic 1-2206

OPEN MON. & FRI. TILL 9:00 P.M. - SAT. 9 TO 5:30

SAN FERNANDO VALLEY RETAIL STORE  
and WHOLESALE WAREHOUSE

4900 LANKERSHIM BLVD.

NORTH HOLLYWOOD, CALIFORNIA • STANley 7-2113 - POplar 6-8668

OPEN 9 TO 9 WEEKDAYS - SAT. 9 TO 6



# SAVE 60% ON 5 OR MORE NEW BOXED REGULAR E.I.A. GUARANTEED RECEIVING TUBES

| TYPE        | LIST  | TYPE       | LIST  | TYPE       | LIST  | TYPE      | LIST  | TYPE        | LIST  | TYPE     | LIST  | TYPE        | LIST  | TYPE         | LIST  | TYPE       | LIST | TYPE       | LIST  |
|-------------|-------|------------|-------|------------|-------|-----------|-------|-------------|-------|----------|-------|-------------|-------|--------------|-------|------------|------|------------|-------|
| 0Z4         | 2.15* | 3BN4       | 2.55  | 5U4G       | 2.05  | 6AX5GT    | 2.95  | 6CH8        | 3.60  | 6P5GT    | 2.80  | 7B5         | 4.75  | 12BE6        | 2.15  | 12Z3       | 3.50 | 42         | 3.50  |
| 0Z4G        | 2.35* | 3BN6       | 3.05  | 5U4GA      | 2.00  | 6AX8      | 3.50  | 6CL6        | 3.75  | 6Q7      | 3.40  | 7B6         | 3.25  | 12BF6        | 1.80  | 14A7       | 3.50 | 47         | 8.70  |
| 1A5GT       | 3.20  | 3B08       | 2.80  | 5U4GB      | 2.00  | 6AZ8      | 4.20  | 6CL8A       | 3.15  | 6Q7G     | 3.20  | 7B7         | 3.30  | 12BH7        | 3.05  | 14B6       | 3.30 | 50A5       | 3.95  |
| 1A7GT       | 3.70  | 3BY6       | 2.35  | 5U8        | 3.30  | 6B8       | 4.70  | 6CM6        | 2.55  | 6Q7GT    | 3.20  | 7B8         | 3.55  | 12BH7A       | 3.05  | 14C7       | 3.35 | 50B5       | 2.65  |
| 1AB5        | 5.70  | 3BZ6       | 2.25  | 5V4GA/G    | 3.30  | 6BA6      | 2.00  | 6CM7        | 2.75  | 6R7GT    | 2.80  | 7C5         | 3.35  | 12BK5        | 3.80  | 14F7       | 3.85 | 50C5       | 2.15  |
| 1AG4 (N)    | 4.25* | 3CB6       | 2.25  | 5V6GT      | 2.20  | 6BA7      | 3.70  | 6CN7        | 2.60  | 6S4A/6S4 | 2.05  | 7C6         | 3.30  | 12BQ6GTA     | 4.45  | 14H7       | 4.60 | 50L6GT     | 2.40  |
| 1AH4 (N)    | 1.90* | 3CF6       | 2.55  | 5X4G       | 2.95* | 6BABA     | 3.55  | 6CQ8        | 3.30* | 6S8GT    | 2.75  | 7C7         | 3.05  | 12BQ6GTB     | 2.40  | 14H7       | 4.10 | 50K6       | 3.20  |
| 1AJ5 (N)    | 2.00* | 3CS6       | 2.40  | 5X8        | 3.25  | 6BC5      | 2.30  | 6CR6        | 2.40  | 6SA7     | 3.40* | 7E6         | 4.05  | 12CU6        | 4.45  | 14Q7       | 4.10 | 50Y6GT     | 2.95  |
| 1AK2        | 3.05  | 3CY5       | 2.80  | 5Y3GT      | 1.75  | 6BC7      | 3.80  | 6CS6        | 2.35  | 6SA7GT   | 3.25  | 7E7         | 4.45  | 12BR7        | 2.60  | 14R7       | 5.15 | 50Y7GT     | 3.05  |
| 1B3GT       | 2.90  | 3DK6       | 2.40  | 5Y4GT      | 2.35* | 6BC8      | 4.00  | 6CS7        | 2.80  | 6SB7Y    | 4.50* | 7F7         | 3.65  | 12BV7        | 3.05  | 17AX4GT    | 2.75 | 71A        | 5.10  |
| 1CSGT       | 3.65  | 3DT6       | 2.20  | 5Z3        | 3.00* | 6BD6      | 2.30  | 6CU5        | 2.35  | 6SC7     | 3.35* | 7F8         | 4.60  | 12BY7A/12BY7 | 3.05  | 17D4       | 2.75 | 75A        | 5.10  |
| 1G3GT/1B3GT | 2.90* | 3LF4       | 4.20  | 5Z4        | 4.55  | 6BE6      | 2.20  | 6CU6/6BQ6GA | 4.35  | 6SC8     | 3.20  | 7H7         | 4.25  | 12C5         | 2.35  | 17DQ6A     | 4.20 | 78         | 5.10  |
| 1HSGT       | 3.05  | 3Q4        | 2.75  | 6A7        | 4.65  | 6BF5      | 3.55  | 6CU8        | 3.65* | 6SF5GT   | 3.20  | 7L7         | 3.40  | 12C5/12CU5   | 2.35  | 18A5       | 4.10 | 83         | 3.50  |
| 1J3         | 2.90  | 3Q3GT      | 3.60  | 6A8        | 4.80  | 6BF6      | 1.80  | 6CX8        | 3.65* | 6SF7     | 3.90  | 7N7         | 3.40  | 12C5         | 2.50  | 19AU4GTA   | 3.45 | 84/6Z4     | 2.60  |
| 1K3/1J3     | 2.90* | 3S4        | 2.45  | 6A8G       | 4.80  | 6BG6GA/G  | 6.50  | 6CY5        | 2.75* | 6SG7     | 3.70* | 7Q7         | 4.10  | 12CA5        | 2.50  | 19BG6GA/   | 6.50 | 85         | 4.35  |
| 1L4 (N)     | 2.65* | 3V4        | 2.35  | 6A8GT      | 4.80  | 6BH6      | 2.70  | 6D6         | 4.35  | 6SH7     | 3.50  | 7S7         | 4.75  | 12CR6        | 2.40  | 19B6GTA    | 3.45 | 88         | 4.35  |
| 1L6         | 3.35  | 4BC5       | 2.35  | 6BA4       | 2.15  | 6BH8      | 3.50  | 6DR8        | 3.50  | 6SJ7     | 3.25* | 7W7         | 4.75  | 12CU6        | 4.45  | 19B6G      | 6.50 | 117L/M7GT  | 10.15 |
| 1LA4        | 4.45  | 4BC8       | 4.05  | 6AB7       | 5.00  | 6BJ6      | 2.60  | 6DA4        | 2.70  | 6SJ7GT   | 2.90* | 7X7         | 5.85  | 12CU6/       | 4.45  | 19J6       | 3.15 | 117N7GT    | 9.30  |
| 1LA6        | 4.10  | 4BN6       | 3.05  | 6AC5GT     | 4.35  | 6BJ7      | 2.95  | 6DB6        | 2.05  | 6SK7     | 3.10* | 7Y4         | 2.75  | 12DQ6GA      | 4.45  | 19T8       | 3.35 | 117Z3      | 2.50  |
| 1LC5        | 4.05  | 4BQ7A      | 4.00  | 6AC7       | 4.25  | 6BK4      | 7.10  | 6DK6        | 2.75* | 6SK7GT   | 3.05  | 7Z4         | 2.75  | 12D4         | 2.75  | 24A        | 4.15 | 117Z6GT    | 4.40  |
| 1LC6        | 4.10  | 4B58       | 3.85  | 6AF4       | 4.00  | 6BK5      | 3.50  | 6DE6        | 2.45  | 6SL7GT   | 3.30  | 8AU8        | 3.55  | 12DF7        | 2.60  | 25A5V5GA   | 4.10 | 7025/ECC83 | 2.95* |
| 1LE3        | 4.25  | 4BU8       | 2.80  | 6AF4A      | 4.00  | 6BK7A     | 3.35  | 6DE7        | 2.95  | 6SN7GT   | 2.60  | 8AW8A       | 3.65  | 12DQ6A/      | 4.20  | 25A4GT     | 2.90 |            |       |
| 1LH4        | 3.95  | 4BX8       | 3.45  | 6AG5       | 2.60  | 6BK7B     | 3.35  | 6DD6GT      | 2.50  | 6SN7GTA  | 2.60  | 8CG7        | 2.80  | 12DQ6        | 4.20  | 25B65      | 3.65 |            |       |
| 1LN5        | 3.95  | 4BZ6       | 2.25  | 6AG7       | 5.10  | 6BL7GTA   | 3.95  | 6DK6        | 2.35  | 6SN7GTB  | 2.60  | 8CM7        | 2.50  | 12DQ5        | 3.05* | 25B6GTB/   | 4.60 |            |       |
| 1NSGT       | 3.65  | 4BZ7       | 4.05  | 6AH4GT     | 3.30  | 6BN4      | 2.50  | 6DN6        | 6.25  | 6S07     | 2.90* | 8CS7        | 2.90  | 12EN6        | 3.05* | 25CU6      | 4.60 |            |       |
| 1PSGT       | 3.50  | 4CB6       | 2.30  | 6AH6       | 4.65  | 6BN6      | 3.05  | 6DQ6A/6DQ6  | 4.10  | 6SQ7GT   | 2.70  | 9UBA        | 3.30  | 12F8         | 2.55  | 25C5       | 2.15 |            |       |
| 1Q5GT       | 4.05  | 4CS6       | 2.35  | 6AK5 (N)   | 4.20* | 6BQ5/EL84 | 2.35* | 6DT5        | 2.90  | 6SR7     | 2.70  | 10DE7       | 2.95  | 12H6         | 2.75* | 25CA5      | 2.50 |            |       |
| 1RS         | 2.55  | 4CY5       | 2.85* | 6AK6 (N)   | 2.90* | 6BQ6GTB/  | 2.90* | 6DT6        | 2.15  | 6SS7     | 3.50  | 12ARGT      | 4.75  | 12J5         | 2.75* | 25CD6GB/GA | 5.85 |            |       |
| 1S4         | 3.65  | 4DT6       | 2.20  | 6AL5       | 1.85  | 6CU6      | 4.35  | 6E5 (N)     | 3.00  | 6T4      | 4.35  | 12AB5       | 2.45  | 12J5GT       | 2.70  | 25CU6/     | 4.60 |            |       |
| 1S5         | 2.55  | 5AM8       | 3.30  | 6AL7GT (N) | 5.75  | 6BQ7A     | 3.95  | 6E8         | 3.20  | 6T8      | 3.35  | 12AGT       | 2.20  | 12J7GT       | 4.20  | 25BQ6GA    | 4.60 |            |       |
| 1T4         | 2.40  | 5AN8       | 3.55  | 6AM4       | 5.90  | 6BR8      | 3.30  | 6F5         | 3.10  | 6T8A     | 3.35  | 12AD6       | 2.25  | 12K5         | 2.70  | 25CU6/     | 4.60 |            |       |
| 1U4         | 2.35  | 5AQ5       | 2.20  | 6AM8A/6AM8 | 3.25  | 6BS8      | 3.75  | 6F6         | 3.65  | 6U5 (N)  | 3.20* | 12AE6       | 1.85  | 12K7GT       | 4.05  | 25BQ6GT    | 4.60 |            |       |
| 1U5         | 2.05  | 5AS4A/5AS4 | 2.15  | 6AN4       | 4.95  | 6BU8      | 2.80  | 6F6G        | 3.65  | 6U8      | 3.30  | 12AF6       | 2.25  | 12L6GT       | 2.45  | 25D6       | 5.55 |            |       |
| 1-V         | 3.65  | 5AS8       | 3.45* | 6AN8       | 3.50  | 6BV8      | 3.20  | 6FG7        | 3.65  | 6UR8A    | 3.30  | 12AJ6       | 1.90  | 12Q7GT       | 3.35  | 25F5       | 2.35 |            |       |
| 1V2         | 2.00  | 5AT8       | 3.25  | 6AQ5       | 2.15  | 6BW8      | 3.30  | 6GGG        | 3.75  | 6V3A     | 4.35  | 12AL5       | 1.75  | 12SA7        | 3.40* | 25G6GT     | 2.25 |            |       |
| 1V6 (N)     | 2.40* | 5AV8       | 4.05  | 6AQ5A      | 2.15  | 6BX7GT    | 4.40  | 6H6         | 3.05* | 6V6      | 4.35  | 12AQ5       | 2.40  | 12SA7GT      | 3.25  | 25H6GT     | 2.70 |            |       |
| 1X2B        | 3.05  | 5AW4       | 2.80* | 6AQ6       | 2.20  | 6BYSGA/G  | 4.20  | 6J5         | 2.70* | 6V6GT    | 2.15  | 12AT6       | 1.65* | 12SC7        | 3.35  | 25Z5       | 3.10 |            |       |
| 2A3         | 6.30  | 5AZ4       | 2.65  | 6AC7GT     | 4.00  | 6BY6      | 2.35  | 6JS5GT      | 2.55  | 6W4GT    | 2.40  | 12A7        | 2.40  | 12SF7        | 3.95  | 25Z6GT     | 2.90 |            |       |
| 2AF4        | 4.05  | 5B8        | 3.90  | 6AR5       | 2.60  | 6BZ6      | 2.25  | 6J6         | 2.80  | 6W6GT    | 2.80  | 12AU6       | 3.05  | 12SG7        | 3.70* | 26         | 4.35 |            |       |
| 2AF4A       | 4.05  | 5BE8       | 3.30  | 6AS5       | 2.40  | 6BZ7      | 4.00  | 6J6A        | 2.80  | 6X4      | 1.65  | 12AU7       | 2.45  | 12SH7        | 3.65  | 27         | 4.35 |            |       |
| 2BN4        | 2.55  | 5BK7A      | 3.40  | 6AS8       | 3.30* | 6BZ8/X155 | 4.25  | 6J7         | 4.00  | 6X5GT    | 2.05  | 12AU7A      | 2.45  | 12SHT        | 3.25* | 35A5       | 3.50 |            |       |
| 2CY5        | 2.80  | 5BR8       | 3.30  | 6AT6       | 1.90  | 6C4       | 1.85  | 6J7GT       | 4.00* | 6X8      | 3.15  | 12AV5GA     | 3.85  | 12SJ7GT      | 3.20  | 35B5       | 2.65 |            |       |
| 3A2         | 3.50  | 5BT8       | 3.30  | 6AT8       | 3.20  | 6C5       | 2.65* | 6K6GT       | 2.35  | 6Y6GA/G  | 3.45  | 12AV6       | 1.65  | 12SK7        | 3.10* | 35C5       | 2.15 |            |       |
| 3A3         | 3.40  | 5C8        | 3.20  | 6AU4GT/GT  | 3.35  | 6C6       | 4.35  | 6K7         | 3.80  | 7AA/XXL  | 3.25  | 12AV7       | 3.20  | 12SK7GT      | 3.05  | 35L6GT     | 2.40 |            |       |
| 3AF4A       | 4.05  | 5CL8       | 3.15  | 6AUSGT     | 4.00  | 6CB5A     | 7.50  | 6K7GT       | 3.80  | 7A5      | 3.85  | 12AW6       | 2.95  | 12SL7GT      | 3.75  | 35W4       | 1.40 |            |       |
| 3AL5        | 1.85  | 5CL8A      | 3.15* | 6AU6       | 2.10  | 6CB6      | 2.25  | 6K7GT       | 3.80  | 7A6      | 3.15  | 12AX4GTA/GT | 2.70  | 12SN7GT      | 2.70  | 35Y4       | 2.75 |            |       |
| 3AU6        | 2.15  | 5CM8       | 3.55  | 6AU6A      | 2.10  | 6CB6A     | 2.25  | 6K8         | 4.45  | 7A7      | 3.50  | 12AX7       | 2.55  | 12SN7GTA     | 2.70  | 35Z3       | 2.75 |            |       |
| 3AV6        | 1.75  | 5CZ5       | 2.85  | 6AU8       | 3.50  | 6CD6GA/G  | 5.80  | 6L6         | 6.10  | 7A8      | 4.45  | 12A27       | 2.75  | 12S07        | 2.90* | 35Z4GT     | 2.35 |            |       |
| 3B2         | 6.25  | 5DH8       | 4.05  | 6AV5GA     | 3.60  | 6CF6      | 2.55  | 6L6GB/GA/G  | 4.20  | 7AF7     | 3.85  | 12B4A       | 2.70  | 12S07GT      | 2.65  | 35Z6GT     | 2.35 |            |       |
| 3BA6        | 2.15  | 5J6        | 2.80  | 6AV6       | 1.65  | 6CG7      | 2.45  | 6L7         | 4.35  | 7AG7     | 3.85  | 12BA6       | 2.00  | 12V6GT       | 2.15  | 35Z8GT     | 1.85 |            |       |
| 3BC5        | 2.35  | 5T4        | 7.25  | 6AW8A/6AW8 | 3.55  | 6CG8      | 3.15  | 6N7         | 4.30  | 7AU7     | 2.60  | 12BA7       | 3.95  | 12W6GT       | 3.00  | 36         | 4.35 |            |       |
| 3BE6        | 2.25  | 5T8        | 3.40  | 6AX4GT     | 2.65  | 6CG8A     | 3.15  | 6N7GT       | 4.35  | 7B4      | 2.05  | 12B6        | 2.25  | 12X4         | 1.80  | 41         | 3.50 |            |       |

Optional-list prices include Federal Excise Tax where applicable. All prices subject to change or withdrawal without notice. \*Indicates price change or tube type added.

## ORDER 50 OR MORE TUBES AND SAVE AN ADDITIONAL 10% OFF TOTAL PRICE

| T.V. ALUMINIZED PICTURE TUBES | Type   | Price   | Type    | Price | Type    | Price |
|-------------------------------|--------|---------|---------|-------|---------|-------|
|                               | 10BP4D | \$10.50 | 17BP4B  | 18.45 | 21AUP4A | 25.50 |
|                               | 14CP4A | 15.45   | 20CP4D  | 20.45 | 24CP4A  | 36.45 |
|                               | 16KP4A | 16.75   | 21ALP4A | 25.50 | 27EP4   | 60.50 |

Full twelve months warranty.  
New Remanufactured R.C.A. Franchise

**NO RETURN OF OLD TUBE NECESSARY!**

## SPECIAL PURPOSE TUBES

| Type   | Price | Type         | Price   | Type  | Price  | Type    | Price | Type | Price | Type   | Price  |       |
|--------|-------|--------------|---------|-------|--------|---------|-------|------|-------|--------|--------|-------|
| 0A2    | 1.26  | 4-125A       | 30.25   | 450TH | 77.00  | 866JR   | 1.95  | 1629 | *     | .25    | 6360   | 4.00  |
| 0A3    | 1.27  | 4-250A/5D22  | 41.25   | 502A  | 2.03   | 868     | 3.75  | 1635 | 2.00  | 7094   | 31.95  |       |
| 0A4G   | 1.68  | 4-250A       | 41.25   | 575A  | 22.15  | 872-A   | *     | 1.95 | 2050  | 1.85   | 8000   | 26.40 |
| OB2    | 1.32  | 4-400A       | * 32.50 | 632-B | 33.00  | 872-A X |       | 9.35 | 5557  | 9.50   | 8005   | 16.20 |
|        |       | 4B32         | 12.00   | 673   | 22.15  | 884     | 1.85  | 5581 | 2.70  | 8008   | 9.35   |       |
| OC3    | 1.27  | 4E27A/5-125B | 40.00   | 801A  | * .95  | 885     | 2.00  | 5582 | 4.95  | 8008AX | 9.35   |       |
| OD3    | 1.27  | 4X150A       | * 12.95 | 802   | 9.85   | 902-A   | 18.00 | 5583 | 4.30  | 9001   | * ** * |       |
| 1C21   | 3.85  | 4X500A       | 121.00  | 804   | 27.15  | 922     | 2.85  | 5584 | 5.20  | 9002   | .75    |       |
| 1P22   | 15.25 | 5BP1-A       | * 2.95  | 805   | 2.95   | 923     | 2.85  | 5618 | 4.93  | 9003   | .75    |       |
| 1P28   | 28.95 | 5R4-GY       | 1.90    | 807   | 2.90   | 927     | 3.75  | 5642 | 1.36  | 9004   | 3.70   |       |
| 1P29   | 3.80  | 5UP1         | * 2.95  | 809   | 5.65   | 929     | 2.00  | 5651 | 1.78  | 9005   | .75    |       |
| 1P39   | 2.15  | 6AG7-Y       | 2.25    | 810   | 10.95  | 930     | 2.85  | 5652 | 6.65  | 9006   | .75    |       |
| 1P40   | 3.00  | 6AS6         | 3.46    | 811-A | * 5.65 | 931-A   | 10.45 | 5654 | 3.80  | EL-38  | 5.55   |       |
| 2AP1-A | 13.65 | 6AS7G        | 4.45    | 812-A | 5.65   | 934     | 3.65  | 5675 | 13.20 | KT-66  | 3.50   |       |
| 2BP1   | 13.80 | 6J4          | 4.33    | 813   | * 9.95 | 935     | 5.65  | 5687 | 4.25  | KT-88  | 4.90   |       |
| 2C39A  | 22.50 | 6L4          | 7.35    | 814   | 23.55  | 954     | * .50 | 5691 | 8.45  | T-40   | 8.30   |       |
| 2D21   | 1.62  | 6SJ7-Y       | 1.45    | 815   | * 3.95 | 955     | * .75 | 5692 | 8.15  | TZ-40  | 8.50   |       |
| 2E24   | 5.25  | 12SW7        | 1.51    | 816   | 2.15   | 956     | * .75 | 5693 | 6.40  | V-70-D | 19.00  |       |
| 2E26   | 3.85  | 12SX7GT      | 1.67    | 828   | 27.50  | 957     | 5.35  | 5696 | 1.90  | ELC6J  | 28.90  |       |
| 2X2A   |       |              |         |       |        |         |       |      |       |        |        |       |



# HAND TOOLS FOR HOME AND HOBBY

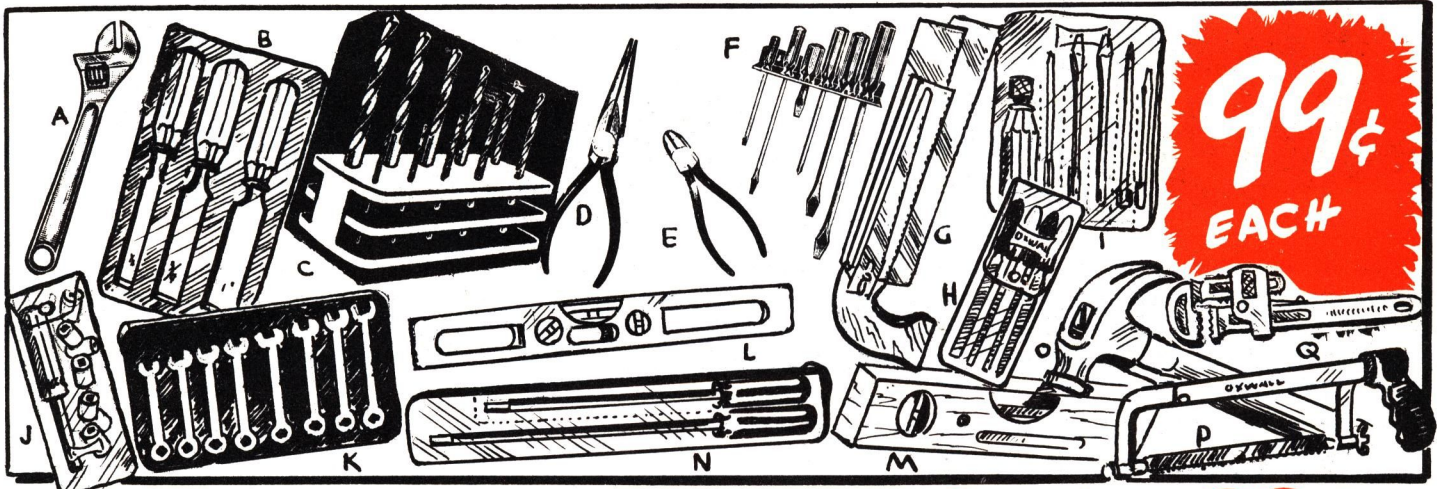

## THESE FINE HAND TOOLS ONLY 99¢

- A. Drop forged crescent wrench choice of 8 or 10 inch size.
- B. Three wood chisels in plastic case. three sizes 1/2, 3/4, and 1 inch.
- C. Set of ten high speed twist drills popular sizes in handy rack.
- D. Long nose side cutting pliers 6 inch size. A must for radio work.
- E. Diagonal cutting pliers. 6 1/4 inch.
- F. Set of six popular size screwdrivers in handy metal wall rack.
- G. Hand saw set with five popular blades.
- H. Set of four small files with handles and plastic carrying case.
- I. Handle with three screwdriver blades, awl and nail puller. With plastic case.
- J. Handle with six popular nut driver sockets. Complete with plastic case.
- K. Set of eight handy double ended wrenches in plastic carrying case.
- L. All aluminum three way level.
- M. Wooden two way carpenters level.
- N. Set of two high voltage insulated screwdrivers. 8 and 10 inch sizes.
- O. 13 inch claw hammer. Wooden handle.
- P. 15 inch hack saw. Plastic handle.
- Q. 9 inch monkey wrench

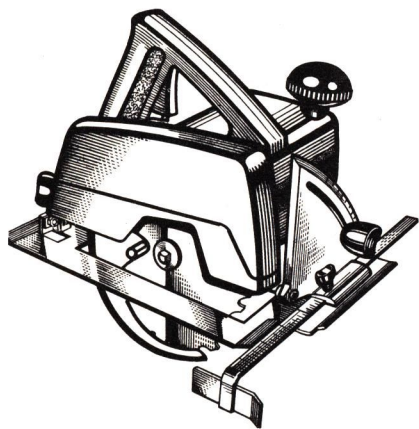

SHOPMATE  
**7 INCH**  
SLIP CLUTCH  
**ELECTRIC SAW**

TRouble-FREE  
OPERATION  
BRONZE BEARINGS  
SLIP CLUTCH

**\$29.25**

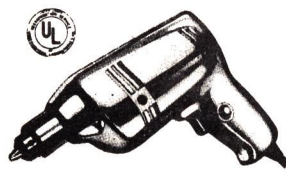

New! Powerful 1/4-in. geared chuck drill with attractive mirror finish. The ruggedly built Universal AC-DC, 115 volt, motor has a full 2.6 ampere rating. No load speed of 2000 RPM. Dynamically balanced armature for smooth, vibration-free performance.

**\$12.95**



**\$19.95**

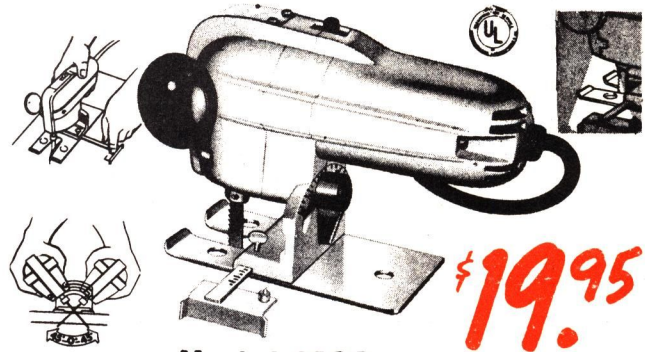

**Model 2100**

**\$19.95**

New! Jig Saw with Jig-Lite . . . You see as you saw! Cuts 2x4's; perfect circles up to 17"; or bevel cuts at 45° on either side! This powerful husky is a whole shop full of saws in one! Does the work of a rip, band, coping, crosscut, scroll, keyhole and hack saw. Cuts everything from metal to leather! Powerful series type motor has a full 1.8 ampere rating. Cuts at 2650 strokes per minute. Motor is amply cooled by internal fan that also handles air jet to keep cutting line clear of sawdust. Has auxiliary handle; side-type switch; 8" calibrated, rip and circle cutting guide; and six foot rubber cord. New Silver-Luster finish. Comes with package of 3 blades. Weight, 5 1/4 lbs.

Model 280 Oscillating Sander with packet of 9 sandpaper strips and lamb'swool polishing bonnet. Orbital motion of 3/8" produces a satin smooth finish free from marks or scratches. Exceptionally compact and lightweight! Only 4 1/2 pounds. Over 25 sq./in. of sanding surface. Sponge rubber pad is 7/8"x3 3/8" with patented knurled, roller-type, clamps. Powerful Universal AC-DC motor has a full 2.0 ampere rating. No load speed of 3500 orbits per/min. Equipped with auxiliary handle; six foot rubber cord; and new mar resistant Silver-Luster finish.

## COLUMBIA ELECTRONIC SALES MAIL ORDER DEPT.

WHOLESALE - RETAIL STORE  
2251 WEST WASHINGTON BLVD.  
LOS ANGELES 18, CALIFORNIA • Republic 1-2206  
OPEN MON. & FRI. TILL 9:00 P.M. - SAT. 9 TO 5:30

SAN FERNANDO VALLEY RETAIL STORE  
and WHOLESALE WAREHOUSE  
4900 LANKERSHIM BLVD.  
NORTH HOLLYWOOD, CALIFORNIA • STANley 7-2113 - POplar 6-8668  
OPEN 9 TO 9 WEEKDAYS - SAT. 9 TO 6







# MORE BARGAINS FROM COLUMBIA THE GEM OF ELECTRONICS

## SELENIUM RECTIFIERS

by International Rectifier Corp.

- 50 ma. 130 v. rs-050 .....69¢
  - 65 ma. 130 v. rs-065 .....79¢
  - 100 ma 130 v. rs-100 .....\$1.19
  - 200 ma. 130 v. rs-200 .....\$1.39
  - 350 ma. 130 v. T-350 .....\$1.79
  - 500 ma. 130v. T-500 .....\$1.99
- all are complete w/ mounting hdwe.

## MIKES-HEADSETS-CORDS

- T-17-D Mike C.A.A. new boxed \$7.50
- T-17 Hand Carbon Mike used \$3.50
- RS-38 new straight cord \$4.95
- 6 ft. Coil cord, 3 wire 95¢
- Chamois headset pads 39¢ pr.
- 3 pr./ \$1.00
- CD-307 5 ft Headset Ext. Cord new 89¢, used 39¢ 3/\$1.00
- RS-38 checked, coil cord \$3.95

## BARGAIN ASSORTMENTS

- 100 Assorted Resistors Late mfg. good values 99¢
- 100 Assorted Condensers Micas, paper, bath tubs \$1.95
- 25 Assorted Potentiometers Good values \$3.95



Wall type Telephone Complete with dial, handset and box with ringing eqpt. perfect for house and garage systems. exc. cond

**\$2.95**  
2 FOR \$5.00



### SPRING COIL CORD

3 conductor microphone cable with lugs in both ends. Normal length is 18 inches. During use it will expand to over 5 ft. Heavy rubber casing to insure long life.

**3 FOR \$2.50** **95¢ ea.**

Headset and Microphone Combo Late model as used by telephone operators and military. Single headphone and swivel mounted mike. Exc. cond. \$5.95

Crystal Socket 2 prong mica filled. holds FT-243 type **15¢ ea.**

RM-29 Remote Control Complete with magneto generator and line matching transformers. Makes a fine phone patch. Can also be used in pairs for portable telephone systems



**\$3.95** LESS HANDSET  
**BRAND NEW TS-13 HAND SET \$3.75**

- TCS Dynamotor 12 v. input- 400v 180 ma output. Brand new \$6.95
- FT-250 Rack for BC-1335 Transceiver New \$3.95
- PE-117 Power Supply 6 or 12 volt input for BC-659 Transceiver New \$3.95
- DM-35 Dynamotor Input 12 volts Output 625 volts 225 ma. small compact New \$7.95 used \$5.95
- FT-237 Rack for BC-603-BC-604 Brand New \$3.50 used \$1.95

## WALL SOLDERING IRONS



115 v..A.C. 60 cycle  
75 Watt \$1.49  
35 Watt \$.89¢

## Weller Complete SOLDERING KIT



- \* Guaranteed-1 Full Year
- \* UL Approved
- \* Regular \$8.95 Value

Features new compact design gun. Instant heat, dual spotlights, "triggermatic" control for instant on-off heat. Included at no extra cost, supply of kester solder, wire bristle soldering brush, and soldering aid for holding and twisting wires. Packed in attractive snap cover case. Single heat rated at over 100 watts. Lightweight for tireless use. Operates on 110 volts, 60 cycle AC only.

**\$5.83** Each

# 4 IN 1 JIG SAW!

PRECISION BUILT **HANDI-CRAFTER POWER TOOL COMPLETE WITH MOTOR**

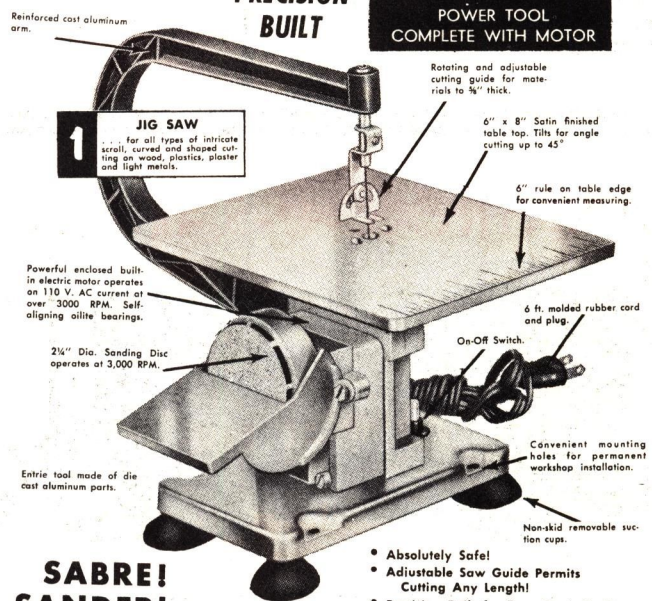

**SABRE! SANDER! FILER!**

- Absolutely Safe!
- Adjustable Saw Guide Permits Cutting Any Length!
- Precision Built for Easy Operation!
- Of Light Weight Cast Aluminum!
- Ideal for Home Work Shop!

**SPECIAL \$14.95**

# COLUMBIA ELECTRONIC SALES MAIL ORDER DEPT.

WHOLESALE - RETAIL STORE  
2251 WEST WASHINGTON BLVD.

LOS ANGELES 18, CALIFORNIA • REpublic 1-2206

OPEN MON. & FRI. TILL 9:00 P.M. - SAT. 9 TO 5:30

SAN FERNANDO VALLEY RETAIL STORE  
and WHOLESALE WAREHOUSE

4900 LANKERSHIM BLVD.

NORTH HOLLYWOOD, CALIFORNIA • Stanley 7-2113 - POplar 6-8668

OPEN 9 TO 9 WEEKDAYS - SAT. 9 TO 6



# LATE MODEL GROUND COMMUNICATIONS!

IN STOCK NOW FOR IMMEDIATE DELIVERY

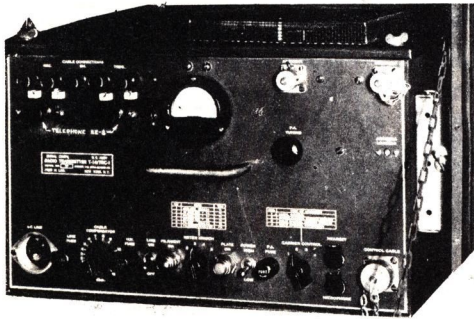

AN/TRC 70-100 mc F.M.  
50 watt Transmitter. One  
channel xtal control. Used  
for 4 channel telephone  
links.  
Write for complete technical info.



AN/GRC-26A- Complete trailer  
provides facilities for sending  
and receiving Radioteletypewriter  
signals over a range of 2-18 mcs.  
Voice and C.W. provided also.  
One of the latest and finest sets  
on the surplus market. *P.U.R.*

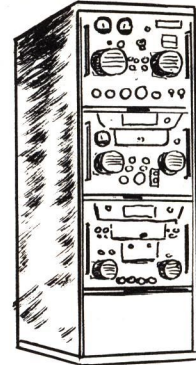

AN/GRC-27- U.H.F Ground  
station. 200-400 mcs. 1750  
channels. 100 watt transmitter.  
110 v. 60 cyc. powered.  
Complete in rack. *P.U.R.*

## AN/GRC 32B

AN/GRC-32B- U.H.F.  
portable ground station.  
uses ARC-27 as basic unit  
with A.C. supply and control  
circuits. May be remote  
controlled. 200-400 mcs.

*P.U.R.*

## AN/PRC-14

AN/PRC-14- U.H.F. pack set  
Consists of Transmitter-  
Receiver and Power pack.  
200-400 mcs.

*P.U.R.*

## AN/PRC-8,9,10

AN/PRC-8, 9, 10  
portable FM back pack sets  
for armored, artillery and  
infantry units. Battery powered.  
Can be operated in vehicles  
and aircraft. up to 12 mile range  
Freq. 20-27.9, 27-38.9,  
38-54.9 mcs. resp. *P.U.R.*

*P.U.R.*

## AN/GRC-3, -4, -5, -6, -7, AND -8



**EXPORTERS  
NOTE!**

## SPARE PARTS AVAILABLE NOW!

|               |               |               |
|---------------|---------------|---------------|
| 3C1084K-95    | 3C1084K-102   | 3C1084K-104   |
| 3C1084K-107   | 5950-251-1177 | 3C1084K-111   |
| 3C1084K-108   | 5950-252-2533 | 3C1084K-113   |
| 3C1084K-114   | 5950-246-2553 | 3C1084K-116   |
| 3C1084K-118   | 5950-219-6537 | 3C1084Z81     |
| 3C1081-11L    | 5950-251-1220 | 2Z9625-63     |
| 2Z9629-242    | 5950-199-4173 | 2Z9643.369    |
| 3C345-3       | 3C345-4       | 3C345-5       |
| 3D9172V       | 3D9088V       | 3D9087VE-6    |
| 3DB500-38     | 3C1084Z28-9   | 3C370-104     |
| 3C899.3A      | 3C323-91A     | 230 0192 00   |
| 2Z9621B-109   | 5950-295-8030 | 2Z7599A-242   |
| 2Z9643.352    | 5950-251-1180 | 5940-256-5741 |
| 5950-250-5541 | 5940-242-4614 | 2Z9631.407    |
| 3Z9625-36.2   | 5930-250-3624 | 6L52010-1     |
| 5935-240-0449 | 5935-240-3347 | 5939-254-2250 |
| 2Z9642.131    | 5945-232-5684 | 3C1084K-105   |
| 3C345-2       | 2Z9611.144    | 5950-232-4464 |
| 3C345-6       | 5950-254-3997 | 5950-237-1471 |
| 3DB35-5       | 5935-162-9212 | 5950-237-1462 |
| 5950-250-8738 | 5940-160-6728 | 5950-232-4455 |
| 2Z9621B-110   |               |               |

Now in stock the WORLDS LARGEST inventory of BRAND NEW surplus maintenance spare parts for portable and vehicular military equipment such as GRC, PRC, VRC, URC, TRC, MRC, and etc. Listed above you will find only a small listing of our vast stock of GRC & PRC components alone. Shortness of space in this small catalog prohibits a complete listing. Within the past 2 months we have received over TEN TRUCK AND TRAILER LOADS OF AN/GRC-3 thru 8 PARTS ALONE !!!! Each item listed is brand new in it's original moistureproof wrapping. Thousands of items not listed. Your inquiries are welcome and promptly answered. SEND US YOUR INQUIRY NOW WHILE QUANTITY AND SELECTION IS STILL AT IT'S PEAK !!!!

## COLUMBIA ELECTRONIC SALES MAIL ORDER DEPT.

WHOLESALE - RETAIL STORE  
2251 WEST WASHINGTON BLVD.  
LOS ANGELES 18, CALIFORNIA • Rpublic 1-2206  
OPEN MON. & FRI. TILL 9:00 P.M. - SAT. 9 TO 5:30

SAN FERNANDO VALLEY RETAIL STORE  
and WHOLESALE WAREHOUSE  
4900 LANKERSHIM BLVD.  
NORTH HOLLYWOOD, CALIFORNIA • Stanley 7-2113 - POplar 6-8668  
OPEN 9 TO 9 WEEKDAYS - SAT. 9 TO 6



**OUR FACILITIES INCLUDE CERTIFICATION  
MIL SPEC PACKING, TECHNICAL INFORMATION**

**TA-2J**

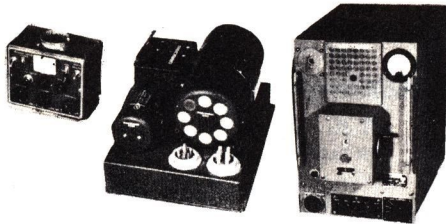

TA-2J- 100 Watt 8 Channel  
Crystal Controlled Transmitter  
Covers 300-600 and 2.9-15 mc.  
Motor switching Can be remote  
controlled. P.U.R.

**BC-728**

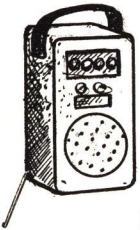

BC-728 portable superhet  
receiver- covers 2-6 mcs.  
preset channels, 4 push  
buttons. Powered by self-  
contained 2 volt wet batty.  
(not supplied)  
Exc. cond. \$9.95

Less tubes or spkr \$7.95  
We will ship what is available

**BC 639 VHF**

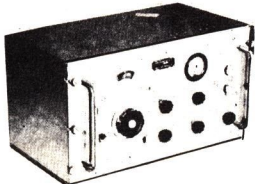

**\$75.00**

BC-639 VHF Ground station  
receiver. Covers 100-156 mcs.  
manual tuning. Superhet.  
operates on 115 or 230 volts  
AC 50-60 cy. when used with  
RA-42 Power supply. \$24.50

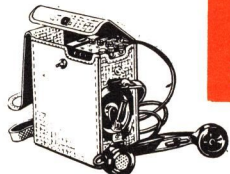

**EE-8  
FIELD  
TELEPHONES**

**\$15.00 ea.**

The reliable military field  
telephone. Operates up to  
5 miles using self contained  
flashlite batteries. Complete  
with lever actuated Handset  
in leather or canvas carrying  
case. Exc. cond. **2 FOR \$25.00**

**APS-6 RADAR**

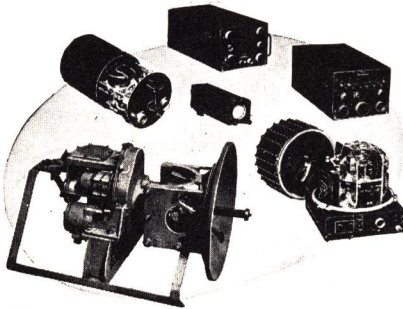

Versatile multi-purpose radar  
set. Can be used for gun pointing  
Beacon, Search up to 100 mile.  
Complete systems. P.U.R.

**APS-4 RADAR**

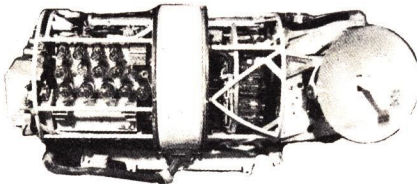

Airborne Search Radar, complete  
for use in planes or boats. "X"  
band. Lightweight. P.U.R.

**BC-603**

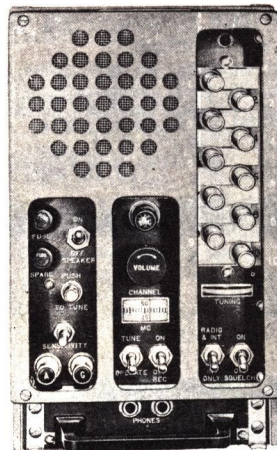

BC-603 20-27 mc FM Recvr  
10 channel push button, w/spkr  
all tubes, less dyn. new \$12.95

**SCR-578**

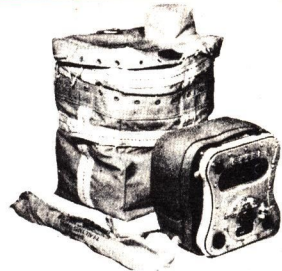

SCR-578 Lifeboat Transmitter  
used for sending S.O.S. for  
rescue planes or boats.

AN/CRT-3A C.A.A. approved  
model of above. P.U.R.

**RTA-1B**

RTA-1B- Bendix 50 Watts  
output, 2500-13000 kcs. 10  
channel, motor switching.  
Receiver and Transmitter with  
self-contained dynamtor supply.  
P.U.R.

**AN/UPM-30**

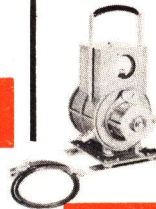

AN/UPM-30 TEST SET  
Consists of TS-545/UP  
Echo Box and accessory  
kit. Covers 1150 to 1350 mcs  
Hand tuned. Input 50 ohms  
Brand new. \$25.00

**TCS**

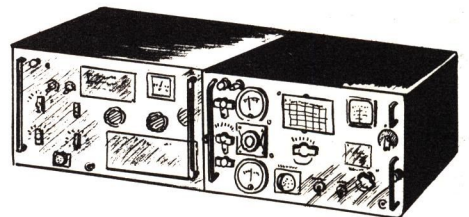

TCS Complete Station  
1.5-12 mcs. VFO  
input power 50 watts phone  
crystal control, 4 channels.  
choice of power supply.  
115 volt a.c. or 12, 24, 115 volt d.c.  
Complete with control box,  
speaker, cables, antenna loading  
coil. Receiver, Transmitter, all tubes,  
less crystals. P.U.R.

**COLUMBIA ELECTRONIC SALES  
MAIL ORDER DEPT.**

WHOLESALE - RETAIL STORE  
2251 WEST WASHINGTON BLVD.  
LOS ANGELES 18, CALIFORNIA • REpublic 1-2206  
OPEN MON. & FRI. TILL 9:00 P.M. - SAT. 9 TO 5:30

SAN FERNANDO VALLEY RETAIL STORE  
and WHOLESALE WAREHOUSE  
4900 LANKERSHIM BLVD.  
NORTH HOLLYWOOD, CALIFORNIA • Stanley 7-2113 - POplar 6-8668  
OPEN 9 TO 9 WEEKDAYS - SAT. 9 TO 6



# BARGAIN CENTER SPECIALS!

THESE BUYS WILL GO FAST **ORDER NOW**

### BC-611 Handie Talkie Parts All New

Mike or earphone cover caps 39¢ pr  
FT-501A "A" batt. holder 59¢ 2/\$1.00  
Ant. Assy 59¢ 2/\$1.00  
Coil & Crystal Set 3525 kc. \$2.95

### Crystal Set 80 each

Brand New FT-241 Holders from  
370.370 kc to 516.667 includes 400  
kc, 455,556, 500 kc.  
Complete Set \$5.95

### Coax Cable

RG-59/U 72 ohm 6¢ ft \$4.95/100  
RG-58/U 52 ohm 6¢ ft \$4.95/100

### 12 V d.c. @ 30 amp. Generator

Compact unit makes fine auxiliary  
generator for your car.  
Brand New. \$3.95

### 60 mcs Hi-Gain I.F. Strip

Model AM-259/ARR-27, uses 8 ea.  
6AK5, p/o ARR-27 exc. less tubes  
While they last! \$1.49

### MC-385-C Hi-lo Adapter

600 ohm to 4 K ohm. Can be  
reversed 39¢ ea. 3/\$1.00

FL-8 1020 cps QRM filter  
good cond. \$1.95¢

### Standard Telephone Dials

3 for \$1.39 exc conc. 49¢

### BC-604 XMTR 20-28 mc.

Brand New less tubes, one  
input xfrmr, top, bottom panels.  
Contains a wealth of parts, inc  
a 1.2 ma 2" meter each \$2.95  
Two for \$5.00

All Types of Control. Boxes  
In Stock  
write us your needs

## AIR FORCE TRAINING BOOKS

Air Force Training Books  
100 to 200 pages each, Bound  
fully illustrated.

Advanced Circuits AF-52-18  
Antenna Systems  
Sheet Metal Maintenance  
Shoran Ground Station  
Aircraft Engine Conditioning  
Airborne Shoran  
Your Body in Flight  
Advanced Circuits  
Aerial Photo Reconnaissance  
8½" x 11" smooth paper  
bound with covers.

Your Choice **\$1.95**

### New Oil Condensers all upright mounting

4 mfd @ 600 v. d.c. 39¢  
5 mfd @ 600 v. d.c. 45¢  
6 mfd @ 600 v. d.c. 49¢  
7 mfd @ 600 v. d.c. 59¢  
10 mfd @ 600 v. d.c. 89¢  
30 mfd @ 600 v. d.c. \$1.95

4 mfd @ 1000 v. d.c. 95¢  
4 mfd @ 2500 v. d.c. \$2.95

### GN-39F Generator for BC-191 self-excited.

output 1000 v. d.c. @ 350 ma.  
14.6 v. @ 25 amps.  
speed 2700 rpm. pulley drive.  
size 8" dia. x 16" long  
shpg. wt. 125 lb. **BRAND NEW** \$8.95

### TBY Vibrator Pack

Powers your TBY from its 4 volt  
d.c. Battery. Brand New with spare  
vibrator. Special \$7.95

### Willard Wet Battery

12- 16 volts @ 68 Amp. hour  
Brand New  
Reduced to \$14.95

### Headsets

HS-23 new hi-imp. \$3.95  
HS-33 used lo-imp \$3.95  
new \$5.50

6 ft. retractable Cord Assy  
on metal reel. Install as a  
trouble lamp in your car.  
19¢ ea. 6/\$1.00

### Electrolytic Condensers

1000 mfd-15 v. d.c. Round Can  
new 35¢ ea. 4 for \$1.00

### Counter Dial Assembly

From BC-191 & BC-375 new \$1.49

### Carbon Pile Voltage Regulator

12 v. d.c model mfd by Eclipse  
Complete with field rheostat  
Brand New \$1.49 ea.

BC-604 Transmitter 30 watts  
10 channel push button FM  
crystal controlled. 20-27 mcs.  
A deal for the new Citizens  
Band. like new complete with  
tubes, less dyn. \$7.50

### BC-684 27-39 mcs. FM

10 channel push button  
With tubes, less dyn.  
Exc. cond. \$7.50

### Dynamotors

Eicor 6v input- 425v-375 ma.  
exc. cond. \$7.95

DM-25 12v input-250 v d.c. @  
50 ma. new \$2.49

RAX Rec. Dyn. 24 v input  
output 166 @ 90 ma.  
used \$2.95

Desk type Telephones  
With handsets.  
Complete with dial \$4.95  
less dial \$3.95

## COLUMBIA ELECTRONIC SALES MAIL ORDER DEPT.

WHOLESALE - RETAIL STORE  
2251 WEST WASHINGTON BLVD.  
LOS ANGELES 18, CALIFORNIA • Republic 1-2206  
OPEN MON. & FRI. TILL 9:00 P.M. - SAT. 9 TO 5:30

SAN FERNANDO VALLEY RETAIL STORE  
and WHOLESALE WAREHOUSE  
4900 LANKERSHIM BLVD.  
NORTH HOLLYWOOD, CALIFORNIA • Stanley 7-2113 - POplar 6-8668  
OPEN 9 TO 9 WEEKDAYS - SAT. 9 TO 6



# EDUCATIONAL ELECTRONICS



## TRANSISTOR SET

Have fun with Electronics... This new easy-to-use Transistor Set enables you to build and rebuild nine (9) different radio sets. A complete working radio can be built in less than 10 minutes.

"Plug-In" features mean safe, simple, fast building of sets—with no soldering or tools. From ages 8 to 21, a set which will delight, teach, and be a lasting fascination. A single flashlight battery runs this set for thousands of hours.

With this set, you can build: A Voice Transmitter; Code Transmitter; 6 Progressive Radio Circuits—from a simple crystal radio, to a transistor radio, to a powerful regenerative long range radio; a Code Blinker Set. Contains all necessary components, plus a complete instruction manual. No knowledge of electricity is needed, but a lasting interest is practically assured. Shpg. Wt., 5 lbs.

**\$10.65**

Electronic Model T-175  
Two-Transistor  
Receiver and Broadcast Set  
Builds and rebuilds 10 Sets  
5 Radio Receivers  
2 Voice Transmitters  
1 Code Transmitter  
1 Musical Tone Producer  
1 Code Practice Set

**\$ 14.95**

No Tools or Soldering Easy to Do!!



## ERECTRONIC Vacuum Tube Set

Builds and rebuilds 15 different radio sets. No soldering or tools needed. Exclusive "Plug-In" features and paint-by-number system of assembling—mean fast, safe construction. Circuits can be built over and over, and additional parts can be added later, to build even more sets.

Operates on 2 batteries (1½ V. flashlight cell and a 45 V. "B"). All the parts are furnished for building:

A Shortwave Radio, Code Transmitter, Voice Transmitter, 2 Crystal Sets, Six Crystal and Tube Radios, 2 Pentode Tube Super Radios, and a Code Practice Oscillator Set. A detailed construction manual is furnished.

Approved by educators—now in use in over 400 schools. Shpg. Wt., 5 lb

**\$14.22**

## Be Sure to Read These NEW GERNSBACK LIBRARY Books

43—MODEL CONTROL BY RADIO. Remote control of model planes, boats, autos. Theory and construction of coders, transmitting and receiving systems, decoders, power control circuits, servomotors, control systems. 112 pages. **\$1.00**

44—BASIC RADIO COURSE. 26 chapters on radio theory as easy to read as a novel. Describes the action of radio circuits in a quick-to-grasp manner. Hard cloth cover. 176 pages. **\$2.25**

45—RADIO TUBE FUNDAMENTALS. The first low priced book to give a complete understanding of radio tubes. 96 pages. **\$1.00**

46—TELEVISION TECHNOTES. Case histories of TV troubles. Describes and solves over 600 tough TV servicing problems. 128 pages. **\$1.50**

47—RADIO & TV HINTS. Hundreds of shortcuts. The hints and kinks in this book are practical, and can be put to work by you. 112 pages. **\$1.00**

48—HIGH FIDELITY. Maximum information on audio design, construction, measurement techniques. Complete section on building amplifiers. 128 pages. **\$1.50**

49—RADIO AND TV TEST INSTRUMENTS. Build 22 instruments: Picture Tube Circuit Analyzer, Picture Tube Tester, Three-Inch Scope, Portable Generator, Signal Tracer, Practical V.T.V.M., Marker Generator, etc. 128 pages. **\$1.50**

50—TV REPAIR TECHNIQUES. How to do signal tracing, service TV in the home, overcome high-voltage troubles, picture-tube circuit difficulties, service horizontal lock, cure TVI, intercarrier buzz, brightness troubles, etc. 128 pages. **\$1.50**

51—TRANSISTORS—THEORY AND PRACTICE. Semi-conductor theory, transistor characteristics, equivalent circuits, transistor amplifiers, oscillators. Gives data on practical transistor circuits, tests and measurements. 144 pages. **\$2.00**

52—THE OSCILLOSCOPE. Chapters on waveforms, the cathode-ray tube, sweep systems, typical scopes, alignment techniques, tests, measurements, experiments. 192 pages. **\$2.25**

53—RADIO-CONTROL HANDBOOK. For all hobbyists interested in radio control for planes, boats, trucks, tractors, etc. Practical construction ideas and suggestions. 192 pages. **\$2.25**

54—PROBES. Explains how probes are used. Describes crystal-demodulator; voltage-doubler; balanced; low capacitance; high-voltage; isolation and direct probes, including a transistorized type. 224 pages. **\$2.50**

55—SWEEP & MARKER GENERATORS for TV and Radio. Complete theory and use of sweep and marker generators. 224 pages. **\$2.50**

56—HIGH FIDELITY CIRCUIT DESIGN. Feedback, drivers, inverters, power supplies, attenuators, filters, equalizers, speaker systems. Hard cloth cover. 304 pages. **\$5.95**

57—THE V.T.V.M.—how it works—how to use it. Written by an RCA engineer, supplies full information on the theory and practical operation of the vacuum-tube voltmeter. 224 pages. **\$2.50**

59—SERVICING RECORD CHANGERS. Excellent source of profit for the service technician. Detailed drawings show how to make repairs. Full servicing information. 224 pages. **\$2.90**

60—RAPID TV REPAIR. Alphabetical listing of hundreds of TV troubles—symptoms and specific information on repair. 224 pages. **\$2.90**

61—TRANSISTOR TECHNIQUES. A useful guide on how to work with and test transistors; how to make transistor measurements; also supplies practical building projects. 96 pages. **\$1.50**

62—TV—IT'S A CINCH! Snappy conversational style with hundreds and hundreds of drawings help you breeze through TV. 224 pages. **\$2.90**

63—TRANSISTOR CIRCUITS. Over 150 practical circuits using transistors only. A guide for the experimenter interested in getting the most out of transistors. 160 pages. **\$2.75**

64—UNDERSTANDING HI-FI CIRCUITS. A new approach to audio. Explains how modern audio circuits work and what you can expect from them. 224 pages. **\$2.90**

65—SERVICING COLOR TV. How to repair color receivers. Illustrated with photos, drawings and troubleshooting charts. 224 pages. **\$2.90**

66—BASIC AUDIO COURSE. Fundamental audio concepts; describes theory and operation of microphones, equalizers, amplifiers, speakers, enclosures. 224 pages. **\$2.75**

67—ELEMENTS OF TAPE RECORDER CIRCUITS. Complete coverage of the electronic portion of tape recorders. For technicians and audiophile. 224 pages. **\$2.90**

68—TV AND RADIO TUBE TROUBLES. Service TV and radio receivers by understanding tube troubles. Explains how to recognize symptoms quickly. **\$2.90**

69—ELECTRONIC HOBBYISTS' HANDBOOK. Scores of circuits for the experimenter and hobbyist. 160 pages. **\$2.50**

### Kitcraft

Educational Electronic  
Devices For Juniors

Kitcraft Model #130  
Ready built Radio with  
Germanium Diode **\$2.99**

Kitcraft Model #200  
Radio Miniature Tube Kit  
With Tube **\$3.99**

Kitcraft Model #400  
Transistor Code Oscillator  
Kit **\$3.99**

Kitcraft Model #300  
Radio Transistor Kit  
with Diode **\$3.99**

# COLUMBIA ELECTRONIC SALES MAIL ORDER DEPT.

WHOLESALE - RETAIL STORE  
2251 WEST WASHINGTON BLVD.

LOS ANGELES 18, CALIFORNIA • REpublic 1-2206

OPEN MON. & FRI. TILL 9:00 P.M. — SAT. 9 TO 5:30

SAN FERNANDO VALLEY RETAIL STORE

and WHOLESALE WAREHOUSE  
4900 LANKERSHIM BLVD.

NORTH HOLLYWOOD, CALIFORNIA • Stanley 7-2113 — POplar 6-8668

OPEN 9 TO 9 WEEKDAYS — SAT. 9 TO 6



# SCHEMATICS

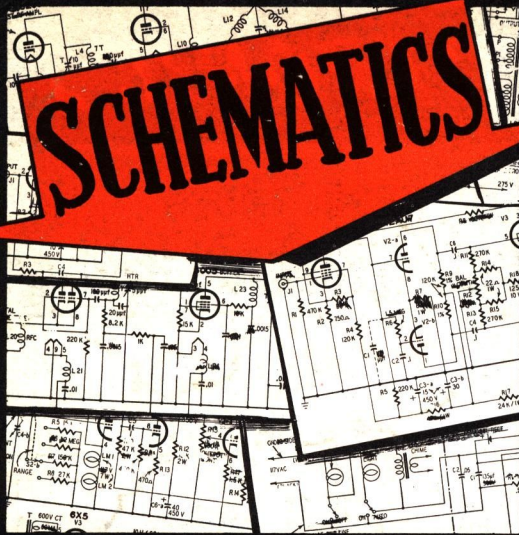

WE HAVE APPROXIMATELY 2000 SCHEMATICS OF ALL ASSORTED GOVERNMENT SURPLUS EQUIPMENT OLD & LATE MODEL SETS TRANSMITTERS · RECEIVERS TEST SETS · POWER SUPPLIES MOTORS · RADAR PANADAPTORS LORAN · SHORAN AND MANY OTHERS. **\$1<sup>00</sup>** each. ONLY...

IF WE CANNOT FILL YOUR ORDER MONEY WILL PROMPTLY BE REFUNDED.

## PE 103 DYNAMOTOR NOW! MOBILE OPERATION EVERYONE CAN AFFORD

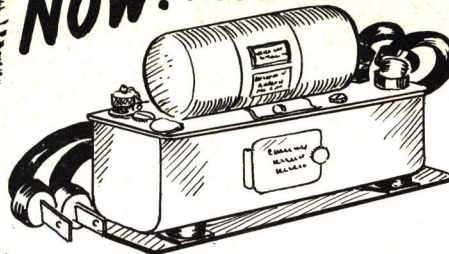

# \$9.95

Now. For the First time anywhere, the world famous PE-103

Dynamotor at the undreamed of low price of \$9.95 Rated at 500 volts at 160 ma. continuous 24 hour a day operation, you can easily draw twice the current intermittantly. Input is either 6 or 12 volts d.c. (selected by a switch). This rugged dynamotor is shock mounted on a base containing complete filtering, relays and circuit breakers. Complete with two 7 1/2 foot cables with lugs. Excellent condition. Shipping Wt. app. 75#

## FIREMEN SHERRIFF COMMERCIAL-CD

BC-683 Receiver was meant just for you. Covers 27-39 Mcs. F.M. Terrific monitor unit. Variable over the complete frequency range. Also incorporates ten push buttons for quick selection of any ten frequencies. May be operated either mobile on 12 volts with dynamotor or 110 volt AC with power pack listed this page. EXCELLANT COND.....

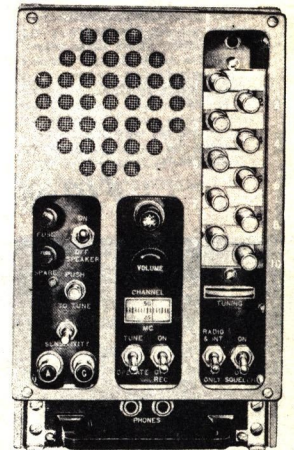

12 VOLT DYNA MOTOR 3.95  
24 VOLT DYNA MOTOR 2.95  
115 AC PACK 11.95  
115 VOLT KIT 7.95

# \$19.95

**COLUMBIA ELECTRONIC SALES**  
2251 W. WASHINGTON BLVD.  
LOS ANGELES 18, CALIFORNIA

FORM 3547 REQUESTED



John D Martin  
2405 - 2nd Ave North  
Billings, Mont

*525 26 John*

Steam Powered Radio.Com

# SUMMER & FALL .....1959