

FM PRESELECTORS  
MODELS 764 AND 765



**TFT**

**TIME AND FREQUENCY  
TECHNOLOGY, INC.**

MODEL NO. 764 and 765  
MANUAL REVISION LEVEL A  
EFFECTIVE SERIAL NO. 764/220-2  
EFFECTIVE SERIAL NO. 765/216-3

#### IMPORTANT MANUAL CHANGES

An AGC output has been added to the rear panel for the user's convenience in indicating the relative input level to the Model 764/765 preselector. With no R.F. input this voltage rests at approximately + 1.5V D.C. With increasing R.F. level this voltage goes negative. At 100uVolts R.F. input this voltage should be approximately -2.5 Volts. At maximum R.F. input the AGC voltage should be approximately -8 volts.

## TABLE OF CONTENTS

		Page
SECTION 1	GENERAL INFORMATION .....	1-1
	1.1 General Description .....	1-1
	1.2 Specifications .....	1-1
	1.2.1 Models 764 and 765 .....	1-1
	1.2.2 Model 764 Only .....	1-2
	1.3 Warranty .....	1-2
	1.4 Claim for Damage in Shipment .....	1-3
SECTION 2	INSTALLATION .....	2-1
	2.1 Unpacking and Inspection .....	2-1
	2.2 Power Requirements .....	2-1
	2.3 Installation and Connections .....	2-1
	2.4 Field Installation of the Model 765 in the Model 763 Cabinet .....	2-2
	2.5 Field Installation of the Model 764 in the Model 763 Cabinet .....	2-2
	2.6 Field Installation of the BCD Frequency Output Option .....	2-4
	2.7 Field Installation of the Carrier Frequency Alarm Option .....	2-5
SECTION 3	OPERATION .....	3-1
	3.1 General .....	3-1
	3.2 Turn-On and Warm-Up .....	3-1
	3.3 Controls, Connectors, and Indicators ..	3-1
	3.3.1 Model 764 Front Panel .....	3-1
	3.3.2 Model 764 Rear Panel .....	3-2
	3.3.3 Model 765 Front Panel .....	3-5
	3.3.4 Model 765 Rear Panel .....	3-5
	3.4 Preselector Operating Procedures .....	3-5
	3.4.1 Model 764 .....	3-5
	3.4.2 Model 765 .....	3-6
	3.5 Use of the Preselectors With the Model 763 .....	3-6
	3.6 Carrier Frequency Alarm (Optional) ....	3-6
	3.7 BCD Frequency Output (Optional) .....	3-6

	Page
SECTION 4	THEORY OF OPERATION ..... 4-1
4.1	Block Diagram Discussion ..... 4-1
4.2	RF Tuner and Prescaler ..... 4-1
4.3	Timebase and Dividers ..... 4-2
4.4	Divide-by-N Divider, Phase Detector, and Loop Amplifier ..... 4-2
4.5	IF Amplifier, Second Mixer, and Limiting Amplifier ..... 4-4
4.6	Power Supplies ..... 4-4
4.7	Counter Circuits and Display (Model 764 Only) ..... 4-5
4.8	19-kHz Multiplier ..... 4-7
4.9	Carrier Frequency Alarm (Optional) .... 4-7
4.10	BCD Frequency Output (Optional) ..... 4-8
SECTION 5	MAINTENANCE ..... 5-1
5.1	General ..... 5-1
5.2	Access ..... 5-1
5.3	Periodic Maintenance ..... 5-1
5.4	TCXO Timebase Calibration (Model 764 Only) ..... 5-2
5.4.1	Calibration Using a Secondary Standard ..... 5-2
5.4.2	Calibration Using a WWVB Receiver ..... 5-2
5.4.3	Calibration Using a Highly Accurate Standard ..... 5-2
5.5	Receiver Performance Checks ..... 5-3
5.6	Troubleshooting Guides ..... 5-4
SECTION 6	SCHEMATIC DIAGRAMS
6.1	Block Diagram
6.2	Chassis Wiring for 764/765
6.3	Main Board Schematic
6.4	RF Tuner Schematic
6.5	Standard 5-MHz Oscillator Schematic
6.6	Temperature-Controlled Crystal Oscillator Schematic
6.7	Thumbwheel Switch Board Schematic
6.8	Channel Selector Board and 19-kHz Multiplier Schematic
6.9	Counter Board Schematic
6.10	Display Board Schematic
6.11	Carrier Frequency Alarm Board Schematic
6.12	BCD Frequency Output Board Schematic
6.13	Power Supply Schematic

## SECTION 1

### GENERAL INFORMATION

#### 1.1 General Description

The TFT Models 764 and 765 FM Preselectors, when used with the Model 763 FM Modulation Monitor, allow off-the-air measurement of the modulation percentage of a selected transmitter carrier in the frequency range of 88 to 108 MHz.

The Model 764 also provides a carrier frequency error measurement capability, and a means of presetting four frequencies for monitoring, so that a competitive comparison can be made of the performance of any four broadcast transmitters within a receiving range by merely selecting each frequency in turn with pushbutton switches.

Two options are available for the Model 764, both field installable:

a. Carrier Frequency Alarm. Actuates an external alarm when the carrier being monitored departs more than a specified amount from its assigned frequency.

b. BCD Frequency Output. Makes a BCD readout of frequency error available at a rear-panel connector for operation of external logging or other equipment.

#### 1.2 Specifications.

##### 1.2.1 Models 764 and 765.

Frequency Range	88 to 108 MHz
RF Sensitivity	50 $\mu$ V for 56 dB SNR, 250 $\mu$ V for 66 dB SNR.
Input Impedance	75 ohms (nominal)
Tuning	4-digit thumbwheel switches, 100-kHz resolution.
IF Selectivity	375 kHz (nominal) for 3-dB bandwidth; 800 kHz (maximum) for 40-dB bandwidth.
Audio Frequency Response	Flat within 0.5 dB from 50 Hz to 75 kHz.
AGC Range	60 dB (+ 20 dB manual attenuation)

1.2.2 Model 764 Only.

Frequency Readout	6 digits
Carrier Frequency Error	
Range	0 to 199.999 kHz
Resolution	1 Hz
Stability	100 Hz/year
Stereo Pilot Frequency	19.000 kHz
Resolution	0.1 Hz
Stability	0.1 Hz in 5 years
SCA Subcarrier Frequency	
Range	23 to 100 kHz
Resolution	1 Hz
Accuracy	1 Hz/year

1.3 Warranty.

TIME & FREQUENCY TECHNOLOGY, INC., warrants each of the instruments of its manufacture to be produced to meet the specifications delivered to the BUYER; and to be free from defects in material and workmanship and will repair or replace, at its expense, for a period of one year from the date of delivery of equipment, any parts which are defective from faulty material or poor workmanship.

Instruments found to be defective during the warranty period shall be returned to the factory with transportation charges prepaid by BUYER. It is expressly agreed that replacement and repair shall be the sole remedy of BUYER with respect to any nonconforming equipment and parts thereof and shall be in lieu of any other remedy available by applicable law. All returns to the factory must be authorized by the SELLER, prior to such returns. Upon examination by the factory, if the instrument is found to be defective, the unit will be repaired and returned to the BUYER, with transportation charges prepaid by SELLER.

Transportation charges for instruments found to be defective within the first thirty (30) days of the warranty period will be paid both ways by the SELLER.

Transportation charges for warranty returns, wherein failure is found not to be the fault of the SELLER, shall be paid both ways by the BUYER.

This warranty does not apply to instruments which, in the opinion of the SELLER, have been altered or misused.

NO OTHER WARRANTY IS EXPRESSED OR IMPLIED. TFT IS NOT LIABLE FOR CONSEQUENTIAL DAMAGES.

1.4 Claim for Damage in Shipment.

Your instrument should be inspected and tested as soon as it is received. The instrument is insured for safe delivery. If the instrument is damaged in any way or fails to operate properly, file a claim with the carrier, or if insured separately, with the insurance company.

WE SINCERELY PLEDGE OUR IMMEDIATE AND FULLEST COOPERATION TO ALL USERS OF OUR PRECISION ELECTRONIC INSTRUMENTS.

PLEASE ADVISE US IF WE CAN ASSIST YOU IN ANY MANNER

Time & Frequency Technology, Inc.  
3000 Olcott St.  
Santa Clara, Ca. 95051

408-246-6365

727-7272

## SECTION 2

### INSTALLATION

#### 2.1 Unpacking and Inspection

Upon receiving the instrument, inspect the packing box and instrument for signs of possible shipping damage. After installing the instrument as described in this section, operate it in accordance with the procedure of Section 3. If the instrument is damaged or fails to operate properly, file a claim with the transportation company, or with the insurance company if insured separately.

#### 2.2 Power Requirements.

Both FM Preselectors derive their power from a 117-volt AC source, 50 to 400 hertz, and require 35 watts. The Preselectors can also be wired for 230-volt operation on special order.

#### 2.3 Installation and Connections.

The connection instructions in this section refer only to the Models 764 and 765. For information on connecting the Model 763 Monitor, refer to the Model 763 instruction manual.

When either the Model 764 or Model 765 is ordered with the Model 763 Monitor, the Preselector is factory installed in the same chassis as the Monitor. The following external connections are required:

a. Connect the PRESELECTOR OUTPUT connector at the rear of the Preselector to the INPUT FROM PRESELECTOR connector J4 at the rear of the monitor using the short coax cable provided.

b. Connect RF INPUT connector J10 at the rear of the Preselector to an FM antenna using a 75-ohm coax cable.

Two additional connections are required for the Model 764 if the frequency of a stereo pilot carrier and/or an SCA subcarrier are to be measured:

c. For stereo pilot carrier frequency measurements, connect a coax cable between 19 KHZ PILOT CARRIER UNIT connector J12 on the Model 764 rear panel to the STEREO PILOT (19 KHZ) connector on the Model 724A Stereo Monitor.

d. For SCA subcarrier frequency measurements, connect a coax cable between SCA CARRIER INPUT connector J13 on the Model 764 rear panel to the SCA SUBCARRIER connector on the Model 730A SCA Monitor.



#### 2.4 Field Installation of the Model 765 in the Model 763 Cabinet.

- a. Remove the top cover from the Model 763.
- b. Remove the blank front panel from the left side of the cabinet.
- c. Referring to Figure 2-1, install the transformer provided in the kit, using two 3/8" No. 6 screws and locking nuts. Wire the transformer primary to the 117 VAC terminals in the Model 763.
- d. Install the two BNC connectors and the RF attenuator on the rear panel as shown in Figure 2-1. Wire the resistors on the RF attenuator in accordance with the wiring diagram, Figure 6-2.
- e. Referring to Figure 2-1, install 7/8" standoffs on the bottom of the chassis and 7/8" standoffs on the rear panel, using 3/8" No. 4 screws.
- f. Install the Preselector onto the standoffs, using No. 4, 3/8" screws.
- g. Connect the rear-panel attenuator and coax connectors as shown in the wiring diagram, Figure 6-2, using the coax cables provided.
- h. Secure the Preselector front panel to the cabinet using the two No. 6 screws that were used for the blank panel.
- i. Plug the 6-pin connector on the transformer cable into J15 on the Power Supply Board.
- j. Reinstall the top cover on the instrument.
- k. Refer to section 2.3 for external connections.

#### 2.5 Field Installation of the Model 764 in the Model 763 Cabinet.

- a. Remove the top cover from the Model 763.
- b. Remove the blank front panel from the left side of the cabinet.
- c. Referring to Figure 2-1, install the transformer provided in the kit, using two 3/8" No. 6 screws and locking nuts. Wire the transformer primary to the 117 VAC terminals in the Model 763.
- d. Install the four BNC connectors and the RF attenuator on the rear panel as shown in Figure 2-1. Wire the resistors on the RF attenuator in accordance with the wiring diagram, Figure 6-2.

## 2.5 (Continued)

- e. Referring to Figure 2-1, install 7/8" standoffs on the bottom of the chassis, 1/2" standoffs on the rear panel, and 1/2" standoffs on the side panel, using 3/8" No. 4 screws.
- f. Install the Preselector onto the standoffs, using No. 4 screws.
- g. Connect the rear-panel coax connectors and the attenuator as shown in the wiring diagram, Figure 6-2, using the coax cables provided.
- h. Secure the Preselector front panel to the cabinet with the two No. 6 screws that were used for the blank panel.
- i. Plug the 6-pin connector on the transformer cable into J15 on the Power Supply Board.
- j. Reinstall the top cover on the instrument.
- k. Refer to Section 2.3 for external connections.

## 2.6 Field Installation of the BCD Frequency Output Option.

This option is available for the Model 764 only. If both this option and the Carrier Frequency Alarm option are to be added, secure both options to the support bracket as shown in Fig. 2-1.

- a. Remove the top cover from the Model 763.
- b. Secure support bracket to the BCD frequency output board as shown in Fig 2-1, using four 3/16" x 4-40 screws.
- c. Install the 24-pin connector in the BCD OUTPUT hole provided on the rear panel, using two 3/8" X 4-40 screws and locking nuts.
- d. Secure the BCD frequency output board to the chassis, as shown in Fig. 2-1 using two 3/8" x 6-32 screws.
- e. Connect the 14-wire flat ribbon cable between J1 on the BCD Frequency Output Board and J1 on the Counter Board.
- f. Connect the other flat ribbon cable attached to the BCD OUTPUT connector to J2 on the BCD Frequency Output Board.
- g. Reinstall the top cover on the instrument.
- h. Connect the external logging or other equipment to the rear-panel BCD OUTPUT connector in accordance with Figure 6-2.

## 2.7 Field Installation of the Carrier Frequency Alarm Option.

This option is available for the Model 764 only. If both this option and the BCD Frequency Output options are to be added, secure both options to the support bracket as shown in Fig. 2-1.

- a. Remove the top cover from the Model 763.
- b. Secure support bracket to Carrier Frequency Alarm Option board as shown in Fig. 2-1, using four 3/16" x 4-40 screws.
- c. If a 24-pin connector is not already mounted in the BCD OUTPUT position on the rear panel, install the furnished connector in that position using two 3/8" No. 4 screws and locking nuts.
- d. Secure the Carrier Frequency Alarm board to the chassis as shown in Fig. 2-1, using two 3/8" x 6-32 screws.
- e. Connect the flat ribbon cable from J1 on the Carrier Frequency Alarm Board to J1 on the Counter Board.
- f. Connect two wires from J2 on the Carrier Frequency Alarm Board the rear-panel BCD OUTPUT connector in accordance with Figure 6-12.
- g. Reinstall the top cover on the instrument.
- h. Connect the external alarm circuit to the rear-panel BCD OUTPUT connector in accordance with Figure 6-12. This is an open collector output, with a maximum rating of 50 mA at 30 V.

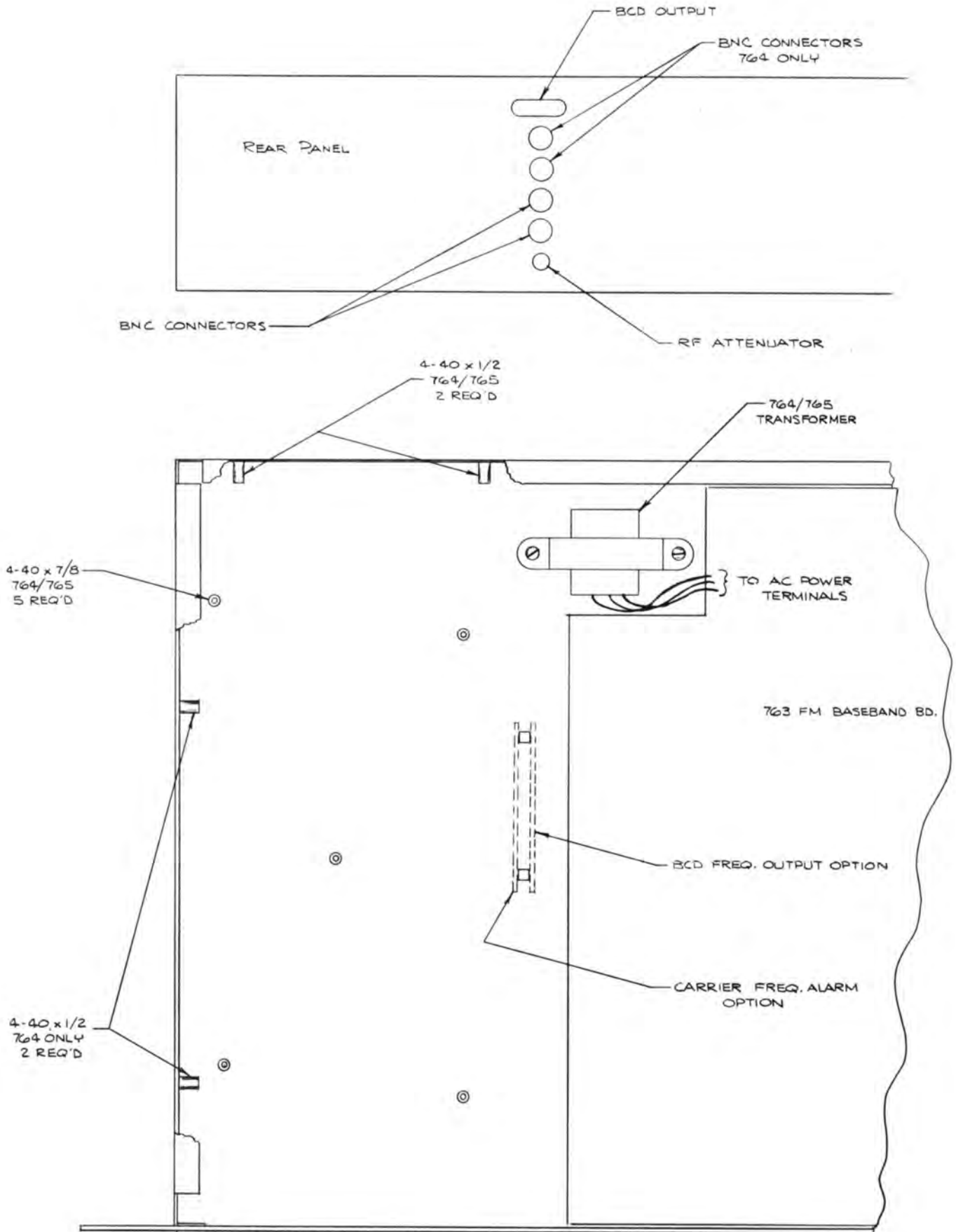

FIGURE 2-1

## SECTION 3

### OPERATION

#### 3.1 General.

The Models 764 and 765 Preselctors allow off-the-air operation of the Model 763 FM Modulation Monitor. In addition, the Model 764 enables measurement of carrier frequency error. It should be noted that when either Preselctor is used, AM measurements cannot be made on the Model 763, and the RF LEVEL pushbutton switch and SET control on the Model 763 front panel are inoperative. The CARRIER POWER ALARM option cannot be used when the Preselctor is installed.

#### 3.2 Turn-On and Warm-Up.

The Preselctors contain no on-off switch. They derive their power (117 VAC, 35 W) from the Model 763 power line cord, and so are on whenever the Model 763 is plugged into an appropriate power source. Either Preselctor can be used for monitoring after a 1-minute warm-up.

#### 3.3 Controls, Connectors, and Indicators.

##### 3.3.1 Model 764 Front Panel.

Fig. 3-1  
Ref. No.

	<u>Name</u>	<u>Function</u>
1	Gate lamp	In normal operation, flashes for 1/2 second every 4 seconds to indicate proper counter operation.
2	FREQUENCY ERROR-kHz indicator	Indicates difference between frequency of monitored carrier and the frequency set up on the selected thumbwheel switches. The + or - at the left of the display indicates that the error is above or below nominal frequency, respectively.
3	COUNTER switch	Enables selection of stereo pilot frequency, main carrier frequency error, or SCA subcarrier frequency for display on the FREQUENCY ERROR indicator.
4	Station selector	Depressing one of these switches selects the frequency set up on the thumbwheel switches on the same row.

Fig. 3-1  
Ref. No.

	<u>Name</u>	<u>Function</u>
5	FREQUENCY-MHz thumbwheel switches	The four rows of thumbwheel switches allow presetting four carrier frequencies.
6	Station selector lamp	The lighted lamp indicates which frequency has been selected.

3.3.2 Model 764 Rear Panel.

Fig. 3-2  
Ref. No.

	<u>Name</u>	<u>Function</u>
1	RF LEVEL control	Adjusts the RF input to the proper level for Preselector operation. Clockwise rotation increases the level into the Preselector.
2	RF INPUT connector J10	Used to connect an antenna to the Preselector.
3	PRESELECTOR OUTPUT connector J11	Used to connect the Preselector output to the Model 763 INPUT FROM PRESELECTOR connector J4.
4	19 KHZ PILOT CARRIER INPUT connector J12	Used to connect the 19-kHz output of a Model 724A Stereo Monitor into the Preselector for frequency measurement.
5	SCA CARRIER INPUT connector J13	Used to connect the SCA subcarrier output of a Model 730A SCA Monitor into the Preselector for frequency measurement
6	BCD OUTPUT connector	Provides a BCD output of the frequency error for logging or other equipment when the BCD Frequency Output option is installed. Also provides an alarm signal when the Carrier Frequency Alarm option is installed. See Figure 6-2 for pin connections.

### 3.3.3 Model 765 Front Panel.

Fig. 3-3

Ref. No.

Name

Function

1	FREQUENCY-MHz thumbwheel switches	Used to tune the Preselector to the frequency to be monitored.
2	OPERATE indicator	LED "ON" indicates sufficient RF level to operate accurately.

### 3.3.4 Model 765 Rear Panel

Fig. 3-4

Ref. No.

Name

Function

1	RF LEVEL control	Adjusts the RF input to the proper level for Preselector operation. Clockwise rotation increases the level into the Preselector.
2	RF INPUT connector J10	Used to connect an antenna to the Preselector.
3	PRESELECTOR OUTPUT connector J11	Used to connect the Preselector output to the Model 763 INPUT FROM PRESELECTOR connector J4.

## 3.4 Preselector Operating Procedures.

### 3.4.1 Model 764.

- a. Make sure the rear panel RF INPUT / PRESELECTOR INPUT on the Model 763 switch is in the PRESELECTOR INPUT position.
- b. Set the rear-panel RF LEVEL control fully clockwise for maximum sensitivity.
- c. Set each row of thumbwheel switches to a carrier frequency to be monitored.
- d. Turn the front-panel COUNTER switch to the MAIN CARRIER position.
- e. Select one of the carrier frequencies by depressing the associated pushbutton, and read the frequency error of this carrier on the FREQUENCY ERROR display.

f. If overloading or interference is present, rotate the RF LEVEL control counterclockwise until satisfactory operation is obtained.

g. If a Model 724A Stereo Monitor has been connected to the Model 763/764 as described in Section 2.3, the pilot carrier frequency can be read on the FREQUENCY ERROR display by turning the COUNTER switch to the PILOT position. Note that the reading is actual frequency, and not frequency error.

h. If a Model 730A SCA Monitor has been connected to the Model 763/764 as described in Section 2.3, the SCA subcarrier frequency can be read on the FREQUENCY ERROR display by turning the COUNTER switch to the SCA position. Note that the reading is actual frequency, and not frequency error.

#### 3.4.2 Model 765.

a. Make sure the rear-panel RF INPUT / PRESELECTOR INPUT on the Model 763 switch is in the PRESELECTOR INPUT position.

b. Set the rear-panel RF LEVEL control fully clockwise for maximum sensitivity.

c. Set the thumbwheel switches for the carrier frequency to be monitored.

d. If overloading or interference is present, rotate the RF LEVEL control counterclockwise until satisfactory operation is obtained.

#### 3.5 Use of the Preselectors With the Model 763.

FM modulation measurements can be made with the Model 763 as described in its instruction manual. AM and Carrier level measurements CANNOT be made when using a preselector.

#### 3.6 Carrier Frequency Alarm (Optional).

This option is available for the Model 764 only. It actuates an alarm connected to the rear-panel BCD OUTPUT connector (see Section 2.7) when the carrier being monitored departs by more than a specified amount from its assigned frequency. The frequency error to trigger the alarm is factory set, and is specified when the option is ordered. No operating controls are involved.

#### 3.7 BCD Frequency Output (Optional).

This option, available for the Model 764 only, provides a BCD readout of frequency error to external equipment connected to the rear panel BCD OUTPUT connector (see Section 2.6). No operating controls are involved. The frequency range of the BCD OUTPUT is  $\pm 199.999$  kHz from the dialed-in center frequency.



NEXT ASSY		USED ON		REVISIONS			
ITEM NO.	EN NO.	PART NO.	DESCRIPTION	DR	CHK	AUTH	DATE
			764				

A  
B  
C  
D  
E

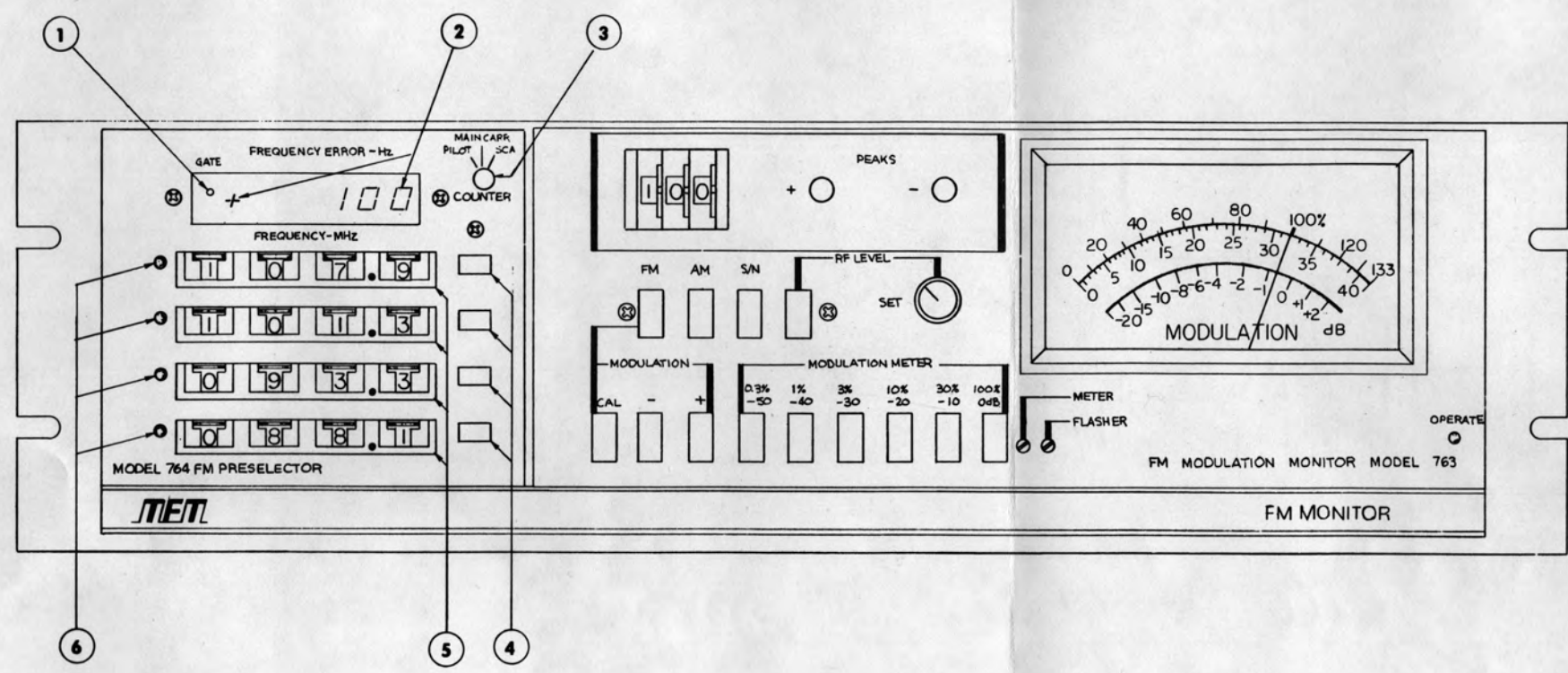

FIGURE 3-1

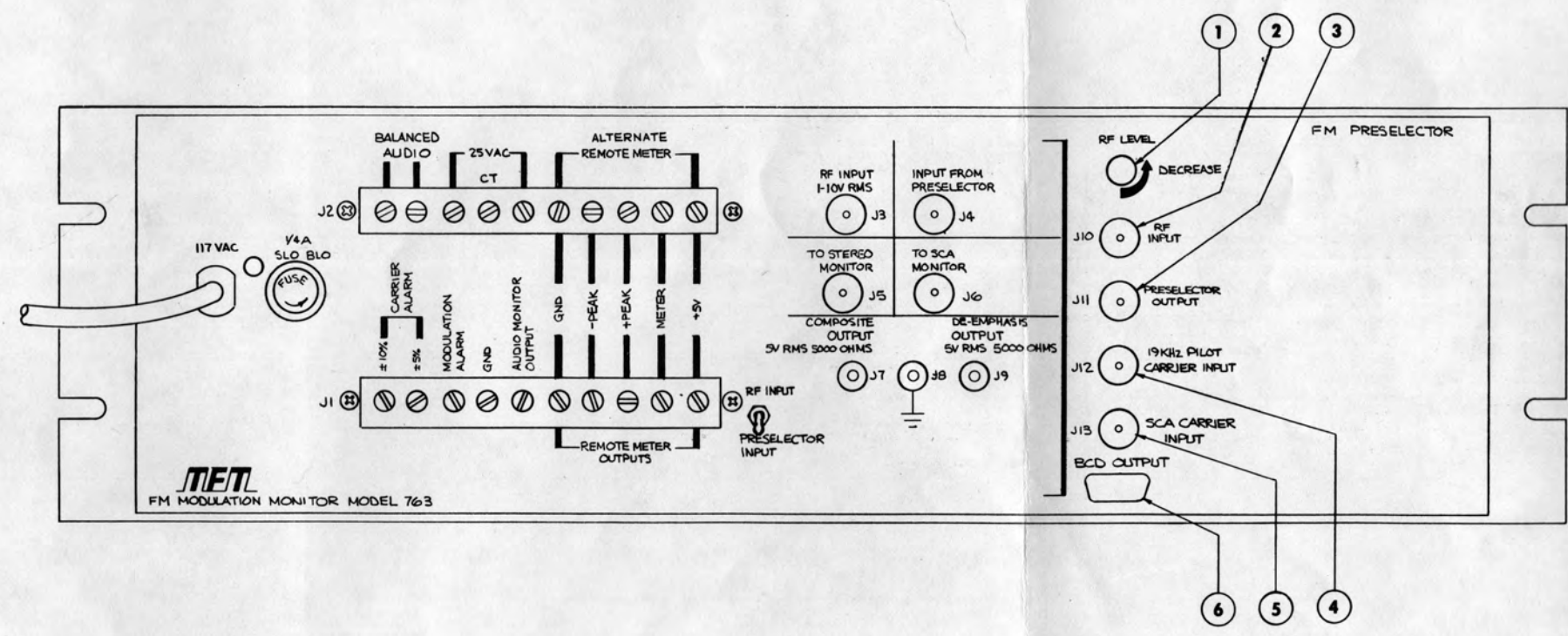

FIGURE 3-2

QTY PER ASSY	ITEM NO.	EN NO.	PART NO.	DESCRIPTION	REP. DES.

REMOVE ALL BURRS AND SHARP EDGES  TOLERANCES UNLESS OTHERWISE SPECIFIED .XX ± ~ ANGULAR .XXX ± ~ ±  DO NOT SCALE THIS PRINT	DRAWN BY: [Signature] DATE: 10-10-76 CHK. BY: [Signature] DATE: 11/17/77 PROJ. ENG.: [Signature] APP. ENG.: [Signature] APPD.: [Signature] ECO NO.:	LIST OF MATERIALS DATE: 10-10-76 <b>TIME &amp; FREQUENCY TECHNOLOGY INC.</b> 3000 Chocoll St., Santa Clara, California 95050 (408) 240-6385 TITLE: MODEL 764 FRONT AND REAR PANEL SIZE: DRAWING NO. D 6600-1120 SCALE: 1:1 SHEET 1 OF 1
---	--	---

If You Didn't Get This From My Site,  
Then It Was Stolen From...  
[www.SteamPoweredRadio.Com](http://www.SteamPoweredRadio.Com)

1. 2. 3. 4. 5. 6. 7. 8.

1 2 3 4 5 6 7 8

NEXT ASSY		USED ON		REVISIONS			
SYM	DESCRIPTION	DR	CHK	AUTH	DATE		
	765						

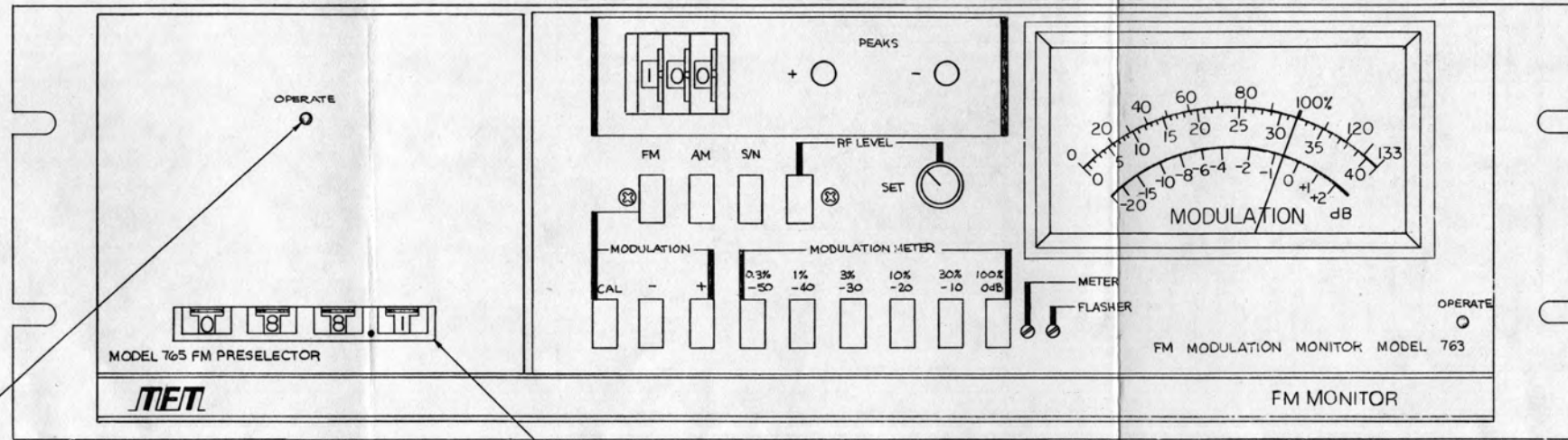

FIGURE 3-3

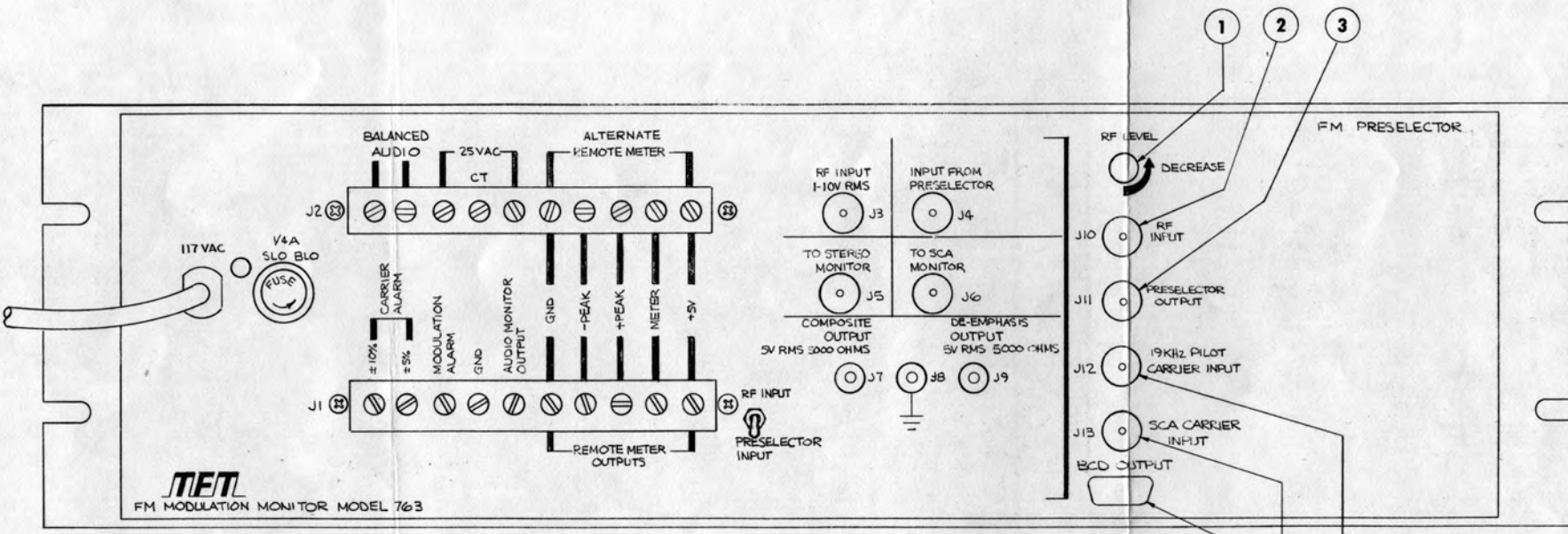

FIGURE 3-4

NOT USED ON 765

ITEM NO.	EN NO.	PART NO.	DESCRIPTION	REF. DES.
QTY PER ASSY				
LIST OF MATERIALS				
DRAWN BY			DATE	
CHK. BY			10/16	
PROJ. ENG.			1/1/77	
MFG. ENG.			1/19/77	
APPD.				
APPD.				
ECO NO.				

<b>REMOVE ALL BURRS AND SHARP EDGES</b>		<b>TET. TIME &amp; FREQUENCY TECHNOLOGY INC.</b> 3000 Olcott St., Santa Clara, California 95050 (408) 248-6365
TOLERANCES UNLESS OTHERWISE SPECIFIED .XX ± ~ ANGULAR .XXX ± ~ ±		
DO NOT SCALE THIS PRINT		
SCALE 1:1 SHIT 1 OF 1		
TITLE <b>MODEL 765 FRONT AND REAR PANEL</b>		SIZE DRAWING NO. <b>D 6600-1121</b>
		REV. <b>A</b>

If You Didn't Get This From My Site,  
Then It Was Stolen From...  
[www.SteamPoweredRadio.com](http://www.SteamPoweredRadio.com)

1 2 3 4 5 6 7 8

## SECTION 4

### THEORY OF OPERATION

#### 4.1 Block Diagram Discussion (Figure 6-1).

The RF input from the antenna is amplified in a tuned amplifier and applied to the first mixer. The LO input for the first mixer, which is 10.7 MHz above the desired received signal, comes from a voltage-controlled oscillator (VCO) in a phase-locked loop. Also in the loop is a synthesized LO consisting of a divide-by-N counter and a phase detector. A 12.5-kHz signal obtained by dividing the output of a precision 10-MHz oscillator is also applied to the phase detector. The divide-by-N counter is adjusted by front-panel thumbwheel switches so that a 12.5-kHz phase detector input is produced when the VCO frequency is correct for the received frequency indicated by the thumbwheel switches. The output of the synthesized LO phase detector is a DC voltage which varies with the phase difference between the two inputs to the synthesized LO; this DC voltage is used to tune the VCO to maintain a zero phase difference. The DC voltage also tunes the input RF amplifier.

After amplification in a linear phase IF amplifier, the 10.7-MHz is applied to a second mixer. The 10-MHz LO input for the second mixer is also derived from the precision 10-MHz oscillator. The resulting 700-kHz IF signal is amplified and delivered to rear-panel PRESELECTOR OUTPUT connector J11 for feeding the Model 763 FM Modulation Monitor.

The Model 764 Preselector also contains a frequency error display. The circuitry for driving this display is shown within dashed lines in Figure 6-1. The time base for the error counter is obtained by dividing the precision 10-kHz frequency derived from the temperature-controlled crystal oscillator. The Preselector output, nominally 700 kHz, is stripped of any amplitude modulation in a limiting amplifier, and the carrier frequency is counted in the error counter. Any difference from 700 kHz is displayed. Since a given error in the carrier RF produces the same error in the IF, the displayed error is also that of the carrier RF.

The counter can also be used to measure the frequency of the 19-kHz pilot carrier from a Model 724A Stereo Monitor and the frequency of the SCA subcarrier from a Model 730A SCA Monitor. The 19 kHz pilot carrier frequency is multiplied by 10 to provide a 0.1-Hz resolution rather than the normal 1.0-Hz resolution.

#### 4.2 RF Tuner (Figure 6-4) and Prescaler (Figure 6-3).

The RF Tuner is a shielded assembly containing a two-stage RF amplifier, a mixer, and a VCO. The input circuit of first RF amplifier Q1, the output circuit of second RF amplifier Q2, and the input circuit of mixer Q3 are all varactor-tuned by means of a DC control voltage from the phase detector in the synthesized LO external to the RF Tuner. VCO Q4, which furnishes the LO input to the mixer, is also varactor-tuned by the same control voltage to a frequency 10.7 MHz above the frequency of the RF amplifiers.

#### 4.2 (Continued).

The VCO also provides an output for the phase-locked loop, which controls the VCO frequency. This output is buffered by Q1 on the Main Board and applied to a divide-by-eight prescaler consisting of dual J-K flip-flops U1 and U2. The VCO output is divided by four in U1 and again by two in U2. Q2 amplifies the divided VCO output to drive the divide-by-N counter.

#### 4.3 Timebase (Figures 6-5 and 6-6) and Dividers (Figure 6-3).

The timebase for the Model 764 Preselector is shown in Figure 6-6. It consists of a 10-MHz temperature-controlled crystal oscillator followed by a divide-by-two flip-flop to give a highly stable 5-MHz output. The 10-MHz output of the crystal oscillator is also brought out for use as the LO input to the second mixer in the Model 764. The Model 765 timebase consists of a 5-MHz crystal oscillator, as shown in Figure 6-5.

The 5-MHz timebase output enters the Main Board through pin 2 of J10 (Figure 6-3). It is divided by 10 in U12, by 10 in U13, and by 4 in U14 to provide a 12.5-kHz pulse train to the phase detector. The 50-kHz output of U13 (pin 8) is divided by 5 in U15 to provide a 10-kHz timebase for the counter circuits in the Model 764 (pin 1 of J7).

#### 4.4 Divide-by-N Divider, Phase Detector, and Loop Amplifier (Figure 6-3).

The output of the divide-by-eight prescaler at the collector of buffer Q2 is applied to the divide-by-N counter consisting of decade counters U8 through U11, J-K flip-flop U21, and associated gates and inverters. The purpose of the divide-by-N counter is to divide the incoming RF by a factor (N) that will produce a 12.5-kHz output when the VCO output is exactly 10.7 MHz above the frequency dialed in on the thumbwheel switches. To accomplish this, the circuit consisting of U4, U5, U6, and U7 presets the divide-by-N counter to the nine's complement of ten times the dialed-in frequency. The counter then counts up from the preset count to 9999, resets to 0, counts up to a fixed count of 10 times the IF offset, and produces an output pulse. The total count is the required value of N, and the output pulses will occur at a PRF of 12.5 kHz if the VCO is exactly 10.7 MHz above the dialed-in frequency.

For example, if a frequency of 106.2 MHz is dialed in, the thumbwheel switches would preset the divide-by-N counter to  $9999 - 1062 = 8937$ . The VCO frequency ( $106.2 + 10.7 = 116.9$  MHz) is divided by 8 in the prescaler to give 14.6125 MHz. When the divide-by-N counter is clocked, it will count up to 9999, reset to 0, and count up to 107, for a total count of  $1062 + 107 = 1169$ , at which time an output pulse is produced. Thus the divide-by-N counter divides the output of the prescaler by 1169 to give the required 12.5 kHz. Any error in the VCO frequency will be reflected in the output frequency of the divide-by-N counter.

The phase detector consists of Q6 through Q10 and associated components. Capacitor C41 charges at a linear rate through constant-current source Q7. When the 12.5-kHz pulsed input from the timebase dividers is high, switch Q10 is turned on and discharges C41. When the 12.5-kHz input is low, switch Q10 opens and allows C41 to charge and thus produce a ramp waveform. At some time during the charging of C41, a short pulse is received from the divide-by-N counter through transformer L8, which turns on sampling gates Q8 and Q9. These gates pass the ramp voltage existing at the time of the sampling pulse to holding capacitor C43. Thus the value of the voltage on C43 will depend on the time at which the sample pulse from the divide-by-N counter arrives with respect to the timing of the ramp.

The DC voltage on C43 is applied through the loop amplifier consisting of buffer U22, active low-pass filter U23 and U24, and amplifier U25 to tuner Z1 to tune the VCO and RF amplifiers. The filter eliminates spikes and other transients in the DC voltage. When the "100s of MHz" thumbwheel switch is on position 1, a ground is applied to the base of Q14 to turn it off and thus turn Q15 on. This places R88 in parallel with R89 to increase the gain of DC amplifier U25 to compensate for the reduction in tuner control sensitivity gain at frequencies above 100 MHz.

The Model 764 requires three Thumbwheel Switch Boards (Figure 6-7) and one Channel Selector Board (Figure 6-8) to accommodate the channel selector switches and the three additional sets of thumbwheel switches. The Channel Selector Boards also plug in, through their 10-pin connectors P8A, P8B, P8C to J8A, J8B and J8C on the counter board which in turn plugs into J8 on the main board. The tuning frequency is determined by closing one of the four front-panel channel selector switches, S1-A through S1-D, shown in Figure 6-8. (When one of these switches is closed, all others are mechanically opened.) Closing a switch applies -0.6 volts to the common bus of the selected row of thumbwheel switches, allowing the required input lines to the nine's complement circuit to be set low, corresponding to the thumbwheel switches that are closed. The common bus for the thumbwheel switches is held at -0.6V instead of 0V because, if 0V were used, the isolation diodes associated with the thumbwheel switches would hold the selected input lines to the divide-by-N counter at +0.6 V instead of 0V. For good noise immunity the divide-by-N lines must be at 0V. The -0.6V level is furnished by Q12 and associated components (Figure 6-3). This voltage also lights the LED (CR-19 on the Main Board, CR1 on the plug-ins) mounted alongside the selected row of thumbwheel switches.

In the Model 765, pins 4 and 5 of J9 on the Main Board are connected together, thus applying -0.6 volts to the thumbwheel switch common bus.

#### 4.5 IF Amplifier, Second Mixer, and Limiting Amplifier (Figure 6-3).

The 10.7-MHz IF from the first mixer in tuner Z1 is amplified by tuned cascade amplifier Q3/Q4, filtered to reject adjacent-channel interference, amplified by Q5, and applied to second mixer U17. The IF output of Q5 is also rectified by CR15, and the resulting DC voltage amplified by U16 to furnish through a 7.5-volt zener diode, CR1, to the first RF amplifier (see Figure 6-4), so that the first 20 dB of the total 60 dB range is implemented by the first mixer, and the remaining 40 dB by the first RF amplifier and the first mixer together. The AGC output of U16 is also applied to Q13, which drives the OPERATE LED for the Model 765 when the AGC voltage is sufficiently high. For the Model 764, a jumper is connected across the LED terminals, and the AGC voltage at the collector of Q13 is applied to pin 2 of counter Z12 on the Counter Board. When the AGC voltage is sufficient, a positive voltage from the collector of Q13 allows the counter to operate normally. When the AGC voltage is insufficient, Q13 applies a logic 0 to pin 2 of Z12, which stops the counter scan and blanks the display segment outputs from the counter.

The input at J10-6 is either 5 MHz from the standard 5-MHz crystal oscillator in the case of the Model 765 Preselector, or 10 MHz from the temperature-controlled crystal oscillator for the Model 764. The output of amplifier Q11 is tuned to 10 MHz, so that Q11 acts as a doubler in the Model 765 and as an amplifier in the Model 764. The tuned circuit of Q11 provides a clean 10-MHz sinewave, which is used as the LO input to second mixer U17. The 700-kHz output at pin 6 of U17 is low-pass filtered to remove the 10-MHz and other mixer products, and applied to limiting amplifier U18. The output of U18 is delivered to rear-panel PRESELECTOR OUTPUT connector J11 via J4-1 of the Main Board. It is fed to the counter (Model 764 only) for measuring carrier frequency error via J5-2.

#### 4.6 Power Supplies (Figure 6-13).

The Power Supply Board furnishes regulated +5V, +12V, -12V, and +24V for operation of all Preselector circuits except those on the Counter Board of the Model 764. It also furnishes unregulated +12V and +18V to the Counter Board. AC input to the Power Supply Board is from a transformer mounted in the cabinet.

One transformer secondary, with grounded center tap, is connected across pins 1 and 2 of J17. Full-wave rectifier CR1/CR2 delivers +12V unregulated to P14-10, and regulator U1 furnishes +5V regulated to P14-3.

Another transformer secondary, with grounded center tap, is connected across pins 4 and 5 of J17. Bridge rectifier CR3 through CR6 develops +18V at the junction of CR5 and CR6 for P14-9; this voltage is regulated by U2 to +12V at P14-5. The -18V at the junction of CR3 and CR4 is regulated by U3 to furnish -12V at P14-7.

The AC voltage between J15-5 and ground is applied to the cascade voltage doubler consisting of C4, C5, CR7, and CR8 to develop +35V across C5, which is regulated by U4 to furnish +24V at P14-1.

#### 4.7 Counter Circuits and Display (Model 764 Only) (Figures 6-9 and 6-10)

The frequency to be counted enters the Counter Board at pin 5 of P7. This input comes from one wiper of the front-panel COUNTER switch. When the COUNTER switch is in the MAIN CARR position, the input is the 700-kHz IF at J5-2 of the Main Board. In the PILOT or SCA position of the switch, the input is 190 kHz from the Channel Selector Board or 67kHz from the rear-panel SCA CARRIER INPUT connector, respectively.

On the Counter Board, limiting amplifier U15 strips off any amplitude modulation to ensure an accurate count of the carrier frequency. The IF signal is then amplified by Q1 and its frequency is divided by 4 in the two U11 flip-flops. This is necessary because some of the comparison and transfer functions in counter module U12 cannot be done when the counter is operating at a 700-kHz counting rate. The time base applied to the counter is 4 seconds rather than 1 second, so that if the IF is precisely 700 kHz, the counter will have counted 700,000 counts in the 4-second period. The divided-down signal is applied through gate U10-4 to the count input (pin 36) of counter U12.

The counter time base comes from the timebase divider on the Main Board through P7-1. This 10-kHz input is divided by decade dividers U1 through U4 to obtain 1 Hz, and then further divided by 4 in flip-flops U5-15 and U5-11 to produce a 1/4-Hz (4 second period) time base.

The 4-second waveform at pin 11 of U5 is processed by U6-3, U6-6, U8-11, U16-6, and U10-10 to produce a preset pulse at the counter load input (pin 31) of counter U12; this allows presetting the counter to a count of 700,000. The same 4-second waveform is also processed by U6-3, U6-6, U8-11, U16-8, Q3, and U10-13 to produce a store pulse which is applied to pin 15 of counter U12 to store the count at the end of the 4-second counting period into the register of U12.

Module U12 is a six-decade, up-down, presettable counter. At the start of each 4-second counting period, the counter is preset to 700,000 (when the front-panel COUNTER switch is in the MAIN CARR position). It then starts counting down toward zero. If there is no error in the IF signal, the count at the end of 4 seconds will be zero. If the IF is less than 700 kHz, an error count will remain at the end of 4 seconds. If the IF is greater than 700 kHz, the counter will count through 0; when it does, an output is produced at pin 39 of U12, which sets flip-flop U9-15 high and sends a logic 1 to the counter's up/down control (pin 40) to cause the counter to start counting up from 0. In this case the counter will again end the 4-second period with an error count. When U9-15 is set high, it also applies the appropriate levels to J and K of U9-11 so that when the store pulse is received at the end of the 4-second period, pin 10 of U9 goes low to turn off Q4 and turn off the vertical segments of the  $\pm$  display, thus indicating a frequency higher than the nominal IF. Because of the LO frequencies used, an increase in RF carrier frequency causes a decrease in the IF frequency. (In the Main Carrier and Pilot modes of frequency measurement, the  $\pm$  sign is turned off.)

#### 4.7 (Continued)

At the end of the 4-second period, the store pulse applied on pin 15 of U12 causes the count present in the counter at that time to be entered into the display register, which is a part of U12. U12 then strobes the display digits by producing an output at pins 24 (LSD) through 29 (MSD) in sequence, to turn on power to each of the digits through transistors Q12 through Q23. As each digit is switched on, the BCD count for that digit is taken from the display register and decoded to light the display segments which will produce the required numeral. These segment outputs appear at pins 4 through 10 of U12, and are delivered to the displays through drivers Q5 through Q11, which ground the appropriate segments.

When counter Z12 is being preset to 700,000, the sixth digit must be the binary equivalent of 7 (111). Diodes CR7, and CR8, and resistors R30, R31 and R32 furnish these three positive voltages to the counter binary input (pins 17 through 19 of U12) from the sixth digit strobe line (J1-3). All other digits for the preset are zeros.

When the COUNTER switch is in the PILOT position, a second wiper on the switch applies +5V to the base of Q4 on the Channel Selector Board to turn it on and light the decimal point on the display. Q2 and Q3 on the channel selector board are also turned on, placing a logic "0" on pins "1" and "2" of J9 on the counter board. This causes the counter to count up in normal counter fashion. When the switch is in the MAIN CARR position, the second wiper grounds the bases of Q2 and Q3; Q2 removes the ground from J9-1 on the Counter Board to allow normal presetting of counter U12, and Q3 removes the ground from J9-2 to allow the sign on the display to indicate either + or - and to allow the counter to count up or down. Q4 on the channel selector board is also turned "OFF", turning "OFF" the decimal point. In the SCA position of the switch, the second wiper is floating, so that Q2 and Q3 are turned on and Q4 is turned "OFF" applying a ground to both J9-1 and J9-2 to preset counter U12 to zero and count up in normal counter fashion. Pin 4 of connector J9 on the Counter Board is not used in the Model 764.

The front-panel GATE lamp, located on the Display Board, is driven by the store pulse through one-shot U17, which stretches the store pulse to approximately 500 milliseconds. Thus the GATE lamp will flash every 4 seconds to indicate normal counter operation.

The Counter Board contains two voltage regulators, U13 and U14, to furnish regulated DC voltage for the counter circuits. They operate on unregulated power supplied from the Power Supply Board.

The Display Board (Figure 6-10) contains the six LED displays which can indicate a frequency error from -199999 Hz to +199999 Hz. DS1 displays the + or - and the most significant digit, which can be only 1 or blank. DS2 through DS6 display the other five digits of the frequency error. R1 through R8 are current-limiting resistors for the LEDs. CR1 is the GATE LED.



#### 4.8 19-kHz Multiplier (Figure 6-8).

The 19-kHz Multiplier on the Channel Selector Board multiplies the pilot frequency by 10 to give a 0.1-Hz resolution of pilot frequency error with the same time base used to achieve 1-Hz resolution on Main Carrier and SCA frequency measurements.

Z1 contains a VCO which is tuned to 190 kHz by C3, R5 and R6. The VCO output at pin 4 is buffered by Q1 to give the 190-kHz output at J16-7. This output is also divided by 10 in U2 and applied through pin 5 of U1 to a phase detector in U1, where it is compared with the incoming pilot frequency at pin 2 of U1. Any phase difference between the two inputs tunes the VCO to reduce the phase difference to zero. The output at J16-7 is thus exactly 10 times the pilot frequency.

The functions of transistors Q2, Q3, and Q4 on this board are described in Section 4.7. Switch S1 is the channel selector switch described in Section 4.4.

#### 4.9 Carrier Frequency Alarm (Optional) (Figure 6-11).

When this option is selected, the customer specifies the frequency error (within the range of 0 to  $\pm 2$  kHz which is to trigger the alarm. This error is factory-preset in BCD form into the counter register (pins 32 through 35 of U12, Figure 6-9). The counter will then deliver an EQUAL pulse to pin 23 of U12 whenever the count is equal to the preset count.

There are three possible situations for the Carrier Frequency Alarm:

a. If the IF being measured is lower than 700 kHz by more than the preset error, counter Z12 on the Counter Board, which starts counting down from 700,000 at the start of each timebase cycle, will never reach the preset count, and no EQUAL pulse will be generated.

b. If the IF is within tolerance (i.e., between the - preset error and the + preset error), one EQUAL pulse will be generated as the counter goes through the - preset error.

c. If the IF is higher than 700 kHz by more than the preset error, two EQUAL pulses will be generated as the counter counts down through 0 and back up again past the + preset error.

The Carrier Frequency Alarm Board plugs into J1 on the Counter Board. Pins 13 through 16 of J1 are the BCD lines into the register, while pins 1, 4, 5, and 6 are the digit strobes. The diodes are factory-installed to furnish the required BCD count for each digit. The EQUAL pulse at pin 12 of J1 clocks flip-flop U1-15 so that, in combination with a SET pulse at the start of each timebase, the output at pin 11 of U1 is high if no or two EQUAL pulses are received during a timebase period, but low if one EQUAL pulse is received. This allows Q3 to ground an external circuit when the IF is lower or higher than the preset tolerance. Q3 is capable of sinking a maximum of 50 mA at 30 V.

#### 4.10 BCD Frequency Output (Optional) (Figure 6-12).

When the BCD Frequency Output option is selected, the BCD and digit strobe outputs of counter Z12 on the counter board are furnished to the BCD Output Board through J2 of the Counter Board. As each strobe line is enabled in turn, from the least significant digit (LSD) (U12-24) to the most significant digit (MSD) (U12-29), the corresponding BCD readout for that digit appears at pins 11 through 14 of U12 (pin 11 is the least significant bit), and is loaded into the register (U2, U3, or U4) on the BCD Output Board that receives a LOAD pulse from the strobe. The content of each register is buffered by U6 and U7, and delivered to the rear-panel BCD OUTPUT connector through J2 of the BCD Output Board.

SECTION 5  
MAINTENANCE

5.1 General.

Since the Models 764 and 765 Preselectors are solid-state instruments and their power requirements are low, no maintenance problems due to high temperature should be encountered, provided the instrument is installed well away from vacuum-tube and other heat-generating equipment. Likewise, because the operating voltages are low, excessive dust accumulation associated with high-voltage devices should not occur.

Access to components and periodic maintenance are covered in Sections 5.2 and 5.3. Three methods of calibrating the TCXO are described in Section 5.4. Receiver performance checks are covered in Section 5.5, and troubleshooting procedures are given in Section 5.6.

Refer to the Model 763 instruction manual for maintenance procedures pertaining to the FM Modulation Monitor.

5.2 Access.

To gain access to the Preselector components, remove six screws from the top cover and then remove the cover.

To remove PC boards and other assemblies from the chassis, proceed as follows:

- a. Remove the two screws holding the front panel to the chassis.
- b. Remove the screws that hold the PC board to the standoffs mounted on the chassis. See Figure 2-1 for location of screws.
- c. Unplug the cables attached to the PC board.
- d. Pull out the PC board.

5.3 Periodic Maintenance.

Except for the Model 764 TCXO calibration described in Section 5.4, the only periodic maintenance required is cleaning. Once a year, or more often in dusty locations, remove the printed-circuit boards and blow off the dust with compressed air.

#### 5.4 TCXO Timebase Calibration (Model 764 Only).

The 10-MHz TCXO should be calibrated periodically. The aging rate of the oscillator is typically 1 ppm per year. For a monitored frequency of 108 MHz, the local oscillator frequency is 118.7 MHz, and the typical error would be 119 Hz per year. Thus, calibration once a year should ensure keeping the monitor's error well within the FCC allowable transmitter frequency error of  $\pm 2$  kHz, even at the high-frequency end of the FM band.

Three calibration methods are described in Sections 5.4.1, 5.4.2, and 5.4.3. For all methods, to adjust the TCXO frequency remove the top cover, as described in Section 5.2. The frequency adjustment screw is located on the side of the TCXO nearest the center of the Preselector, and can be turned with a small screwdriver.

##### 5.4.1 Calibration Using a Secondary Standard.

A secondary standard such as the HP Model 5245 counter or the HP 105A quartz oscillator can be used to calibrate the TCXO.

- a. Remove the instrument from the rack and remove the top cover.
- b. Connect the 5-MHz output of the secondary standard to the external sync input of a 10-MHz oscilloscope. Adjust the oscilloscope for external sync.
- c. Connect the 5-MHz OUTPUT connector on the rear panel of the Model 764 to the vertical input of the oscilloscope.
- d. Adjust the oscilloscope vertical gain for full-scale deflection and adjust the horizontal sweep speed to 0.1 microsecond per centimeter.
- e. Adjust the Model 764 TCXO frequency for the least movement of the oscilloscope display.

##### 5.4.2 Calibration Using a WWVB Receiver.

- a. Connect the rear-panel 5-MHz OUTPUT connector to the WWVB receiver.
- b. Refer to the WWVB receiver instructions for the proper setup and method of calibrating the TCXO.

##### 5.4.3 Calibration Using a Highly Accurate Standard.

The 5-MHz output of the TCXO can be compared with the 5-MHz output of a rubidium or other highly accurate standard. This is the most accurate way to calibrate the TCXO.

### 5.4.3 (Continued).

The TCXO and standard frequencies can be compared in an oscilloscope in any of three ways:

a. Apply the TCXO output at the Model 764 rear-panel 5-MHz OUTPUT connector to the vertical input of the oscilloscope and apply the 5-MHz output of the standard to the horizontal input of the oscilloscope. Adjust the TCXO frequency for a steady Lissajous pattern.

b. Using a dual-trace oscilloscope, apply the TCXO output from the rear-panel 5-MHz OUTPUT connector to one oscilloscope channel, and apply the 5-MHz output of the standard to the other channel, triggering the oscilloscope sweep from the standard frequency. Adjust the TCXO frequency until the TCXO waveform is steady or moves very slowly with respect to the standard waveform.

c. Using the output from the frequency standard as the oscilloscope trigger, apply the TCXO output from the rear-panel 5-MHz OUTPUT connector to the vertical input of the oscilloscope. Adjust the TCXO frequency for a steady pattern.

### 5.5 Receiver Performance Checks.

To determine whether the receiver circuits of the Preselector are operating satisfactorily, proceed as follows:

a. Connect the output of an appropriate signal generator to the rear-panel RF INPUT connector, and set the signal generator to some frequency in the band from 88 to 108 MHz.

b. Set the RF LEVEL control on the Preselector rear panel fully clockwise (minimum attenuation).

c. Adjust the signal generator output to a minimum, and then increase the output until the OPERATE light in the Model 765 or the display in the Model 765 just comes on. The signal generator output for this condition should be 100 microvolts or less.

d. With no modulation on the signal from the signal generator, and with the S/N switch on the Model 763 front panel depressed, the residual noise measured by the Model 763 should be less than 56 dB. (Refer to the Model 763 instruction manual for the method of measuring residual noise.)

e. Increase the signal generator output to 1 millivolt. The residual noise should drop to less than 66 dB.

If the Model 765 receiver circuits pass this test, the Preselector is operating satisfactorily. If the Model 764 receiver circuits pass this test and if the counter indicates the correct frequency of the signal generator output, the Model 764 is operating satisfactorily.

## 5.6 Troubleshooting Guides.

Two troubleshooting trees are presented here as an aid to isolating the cause of a failure. The Receiver Troubleshooting Guide (5.6.1) is applicable to both the Model 764 and the Model 765. If the Model 764, is malfunctioning, use the Receiver Troubleshooting Guide first, and then, if necessary, the Counter Troubleshooting Guide (5.6.2.). If only the counter is malfunctioning, go directly to the Counter Troubleshooting Guide.

For both guides, start at the top and do whatever is required to answer the question in the first box. Then proceed to the next operation along the route determined by the answer to the first question. Continue this sequence until the fault is found.

5.6.1 Receiver Does Not Work

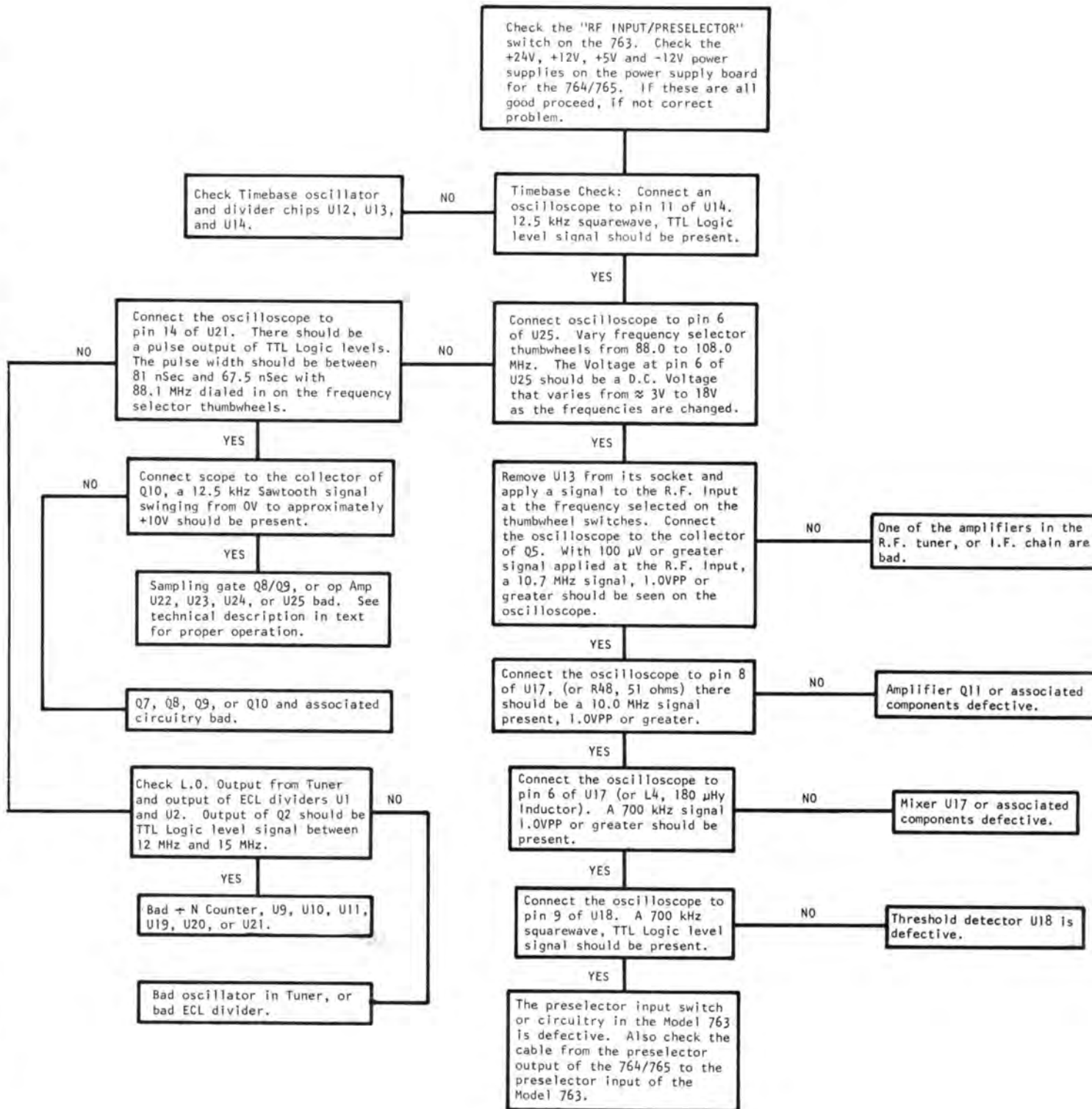

5.6.2 Counter Does Not Work

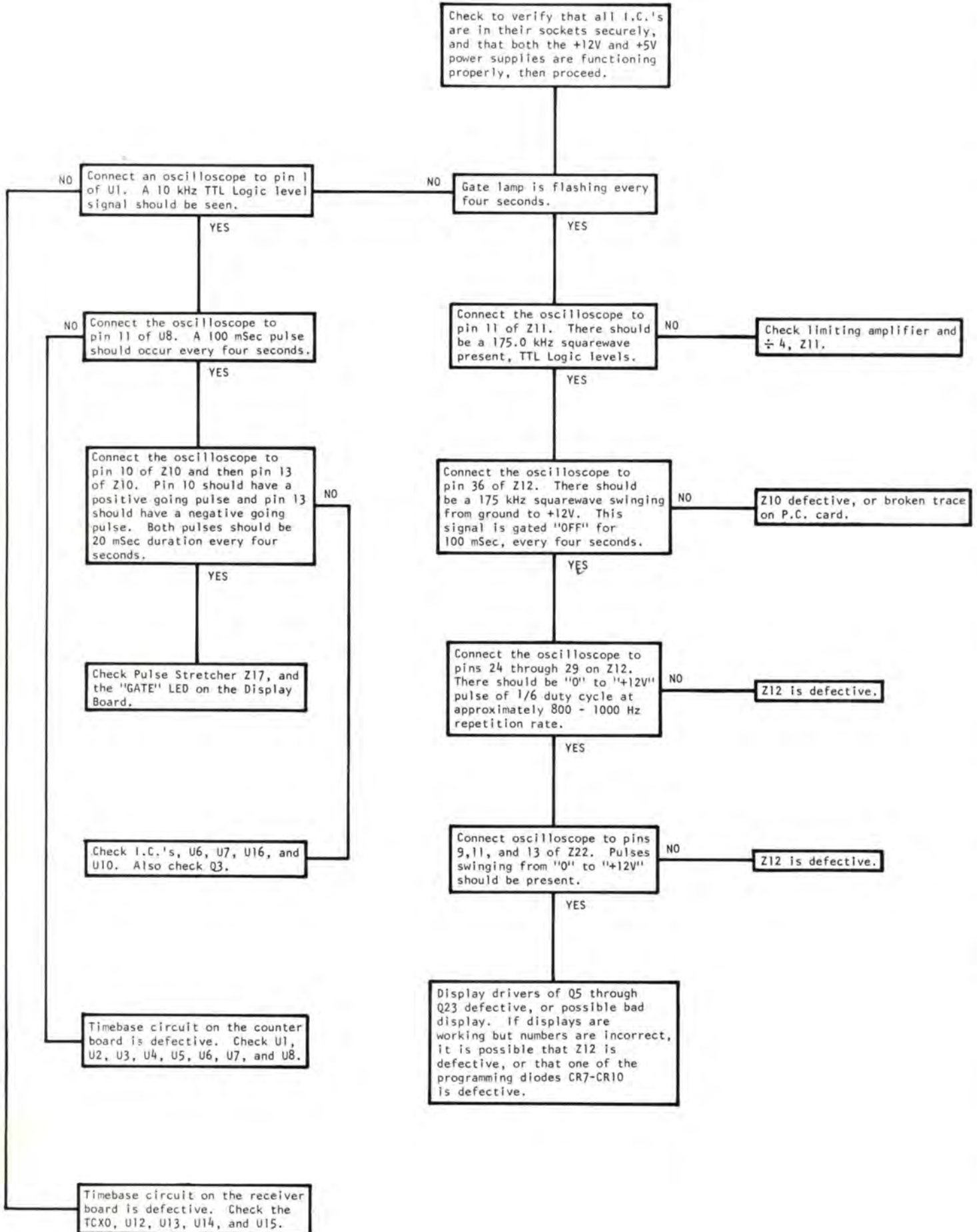



NEXT ASSY		USED ON		REVISIONS					
		764/765		SYM	DESCRIPTION	DR	CHK	AUTH	DATE
				A	REL TO PRODUCTION	T	D		

A  
B  
C  
D

A  
B  
C  
D

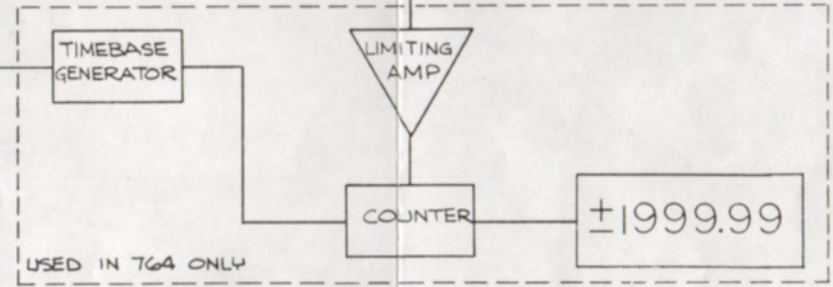
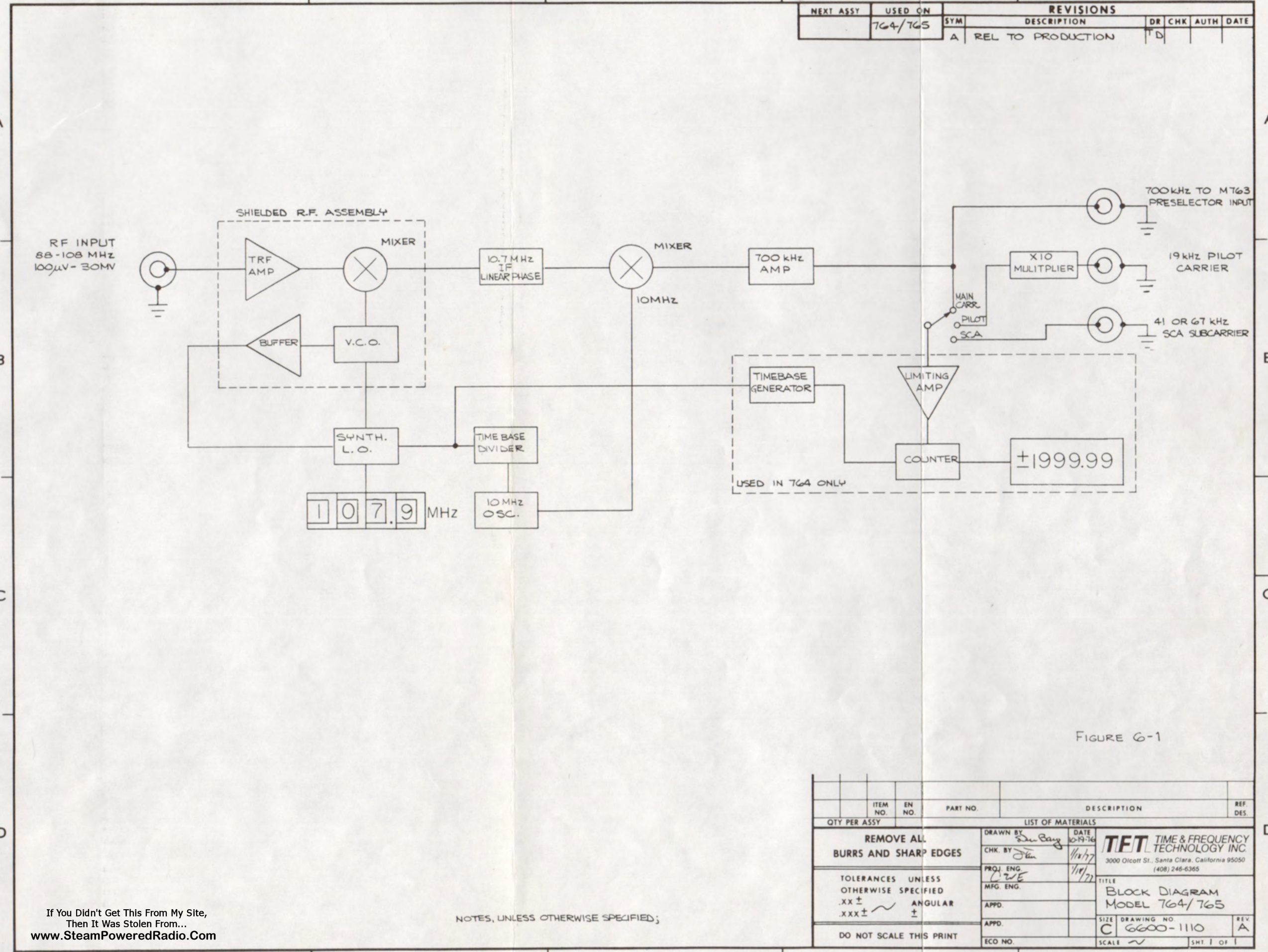

FIGURE 6-1

QTY PER ASSY	ITEM NO.	EN NO.	PART NO.	DESCRIPTION	REF DES.
LIST OF MATERIALS					
REMOVE ALL BURRS AND SHARP EDGES			DRAWN BY: <i>De Bay</i> DATE: 10-19-76 CHK. BY: <i>Jen</i> 11/2/77 PROJ. ENG: <i>CWE</i> 11/17/77 MFG. ENG.: APPD.: APPD.: ECO NO.:	<b>TFT</b> TIME & FREQUENCY TECHNOLOGY INC. 3000 Olcott St., Santa Clara, California 95050 (408) 246-6365 TITLE: BLOCK DIAGRAM MODEL 764/765 SIZE: C DRAWING NO: 6600-1110 REV: A SCALE: ~ SHT 1 OF 1	
TOLERANCES UNLESS OTHERWISE SPECIFIED .XX ±      ANGULAR .XXX ±      ±					
DO NOT SCALE THIS PRINT					

NOTES, UNLESS OTHERWISE SPECIFIED;

If You Didn't Get This From My Site,  
Then It Was Stolen From...  
[www.SteamPoweredRadio.Com](http://www.SteamPoweredRadio.Com)

1 2 3 4 5

NEXT ASSY	USED ON	REVISIONS					
		SYM	DESCRIPTION	DR	CHK	AUTH	DATE
	764/765	A	REL TO PROD	TD			

NOTES, UNLESS OTHERWISE SPECIFIED;  
 1. PUSHBUTTON SWITCH BD. AND COUNTER BD. ALONG WITH THE ASSOCIATED WIRING ARE ON 764 ONLY.  
 ⚠ ON 765, THIS WIRE GOES TO THE FRONT PANEL 'OPERATE' LED.

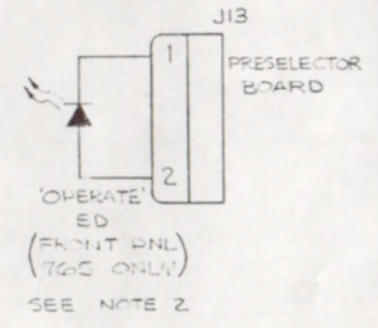
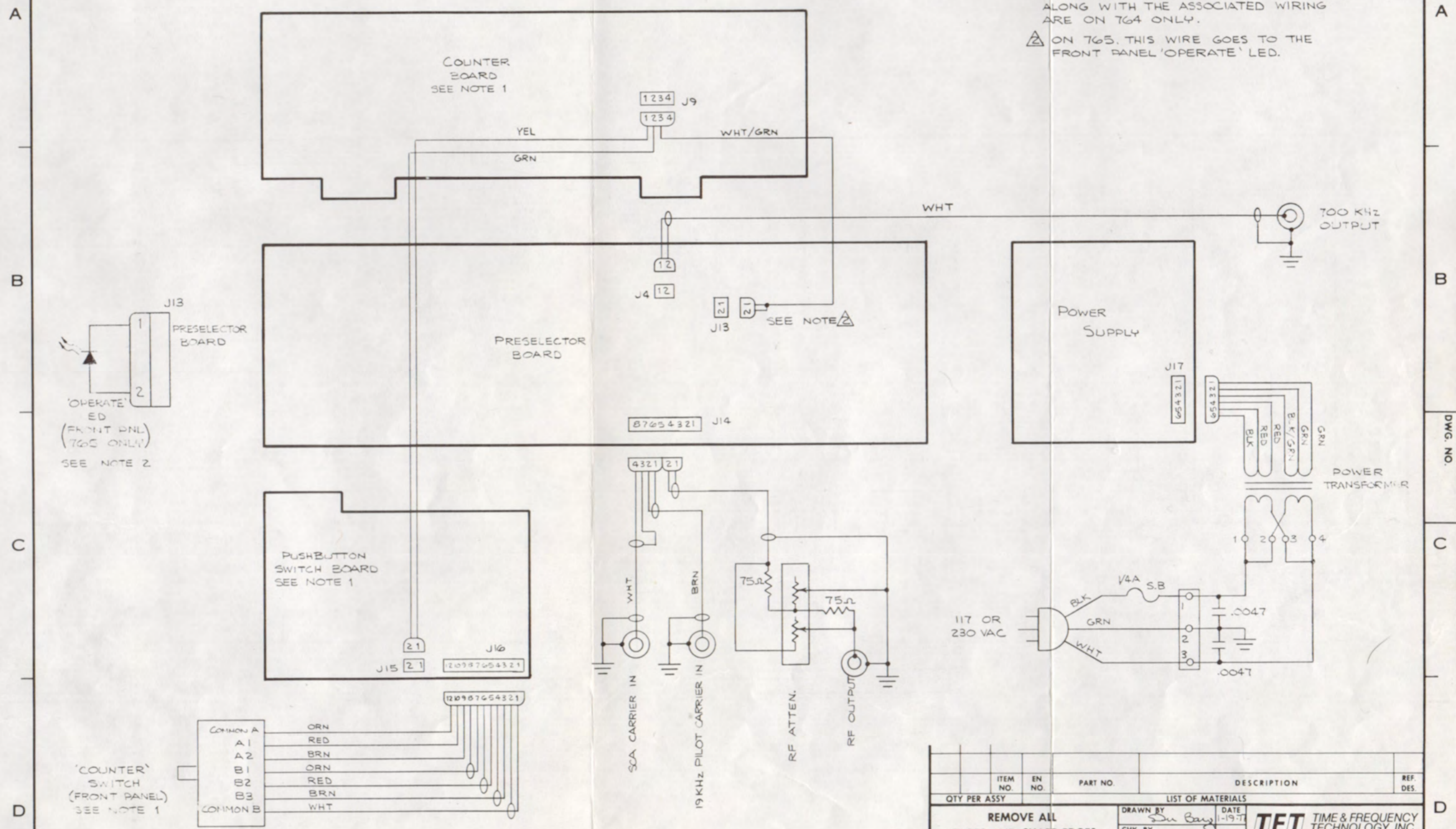

'COUNTER' SWITCH (FRONT PANEL) SEE NOTE 1

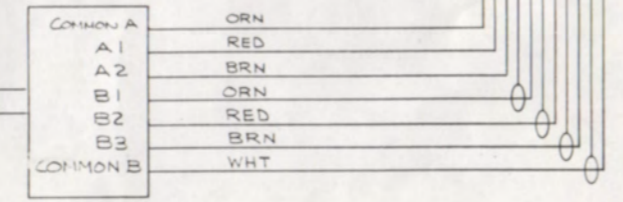

QTY PER ASSY	ITEM NO.	EN. NO.	PART NO.	DESCRIPTION	REF. DES.
LIST OF MATERIALS					
REMOVE ALL BURRS AND SHARP EDGES			DRAWN BY	DATE	
			CHK. BY	1-19-77	
TOLERANCES UNLESS OTHERWISE SPECIFIED			PROJ. ENG.		
.XX ±			MFG. ENG.	1/19/77	
.XXX ±			APPD.		
			APPD.		
			ECO NO.		
DO NOT SCALE THIS PRINT			TITLE		
			WIRING DIAGRAM MODEL 764/765		
			SIZE	DRAWING NO.	REV.
			C	6601-1920	A
			SCALE	SHT. OF	
				1	1

1 2 3 4 5

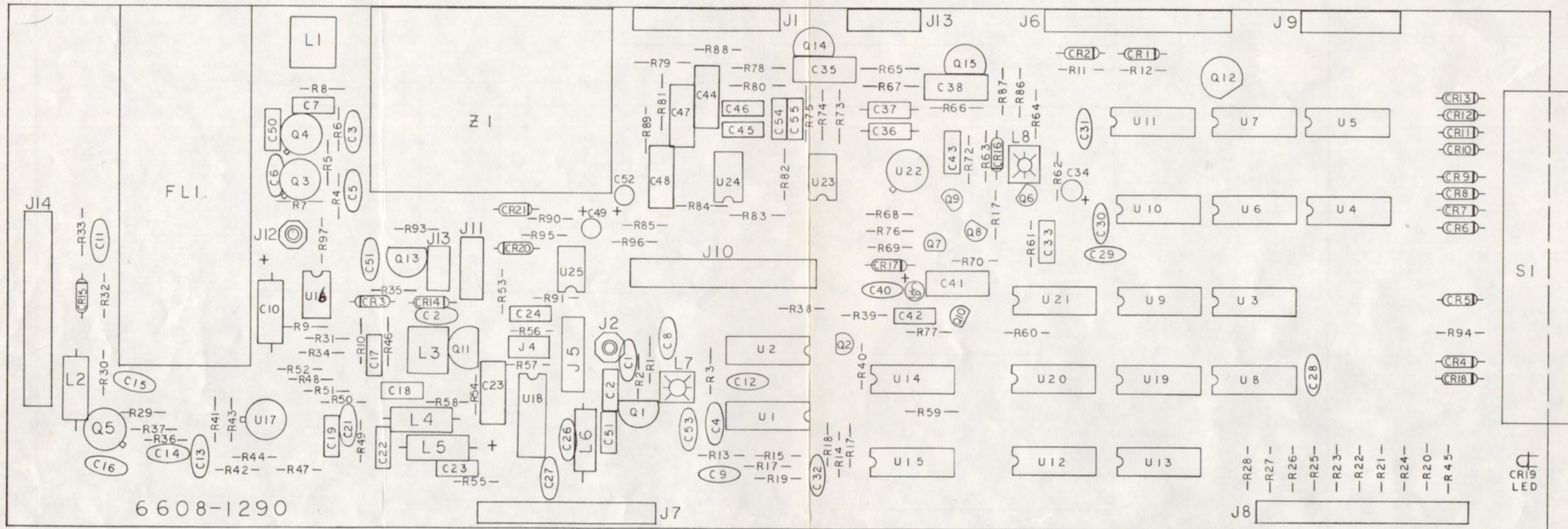

Model 764/765

Preselector

Assembly # 6608-1290

Ckt. Ref.	Description	TFT Stock No.
C01	Cap Cer Disc .05 Mfd	1005-5039
C02	Cap Mica 75 PF	1001-0750
C03	Cap Cer Disc .05 Mfd	1005-5039
C04	Cap Cer Disc .005 Mfd	1005-5049
C05	Cap Cer Disc .05 Mfd	1005-5039
C06	Cap Cer Disc .05 Mfd	1005-5039
C07	Cap Tub 6.8 PF	1000-0068
C08	Cap Cer Disc .01 Mfd	1005-1039
C09	Cap Cer Disc .01 Mfd	1005-1039
C10	Cap Elect 1.0 Mfd 25V	1010-0010
C11	Cap Cer Disc .05 Mfd	1005-5039
C12	Cap Cer Disc .01 Mfd	1005-1039
C13	Cap Cer Disc .05 Mfd	1005-5039
C14	Cap Cer Disc .05 Mfd	1005-5039
C15	Cap Cer Disc .05 Mfd	1005-5039
C16	Cap Cer Disc .05 Mfd	1005-5039
C17	Cap Mica 2000 PF	1001-0202
C18	Cap Mica 430 Pf	1001-0431
C19	Cap Mica 360 PF	1001-0361
C20	Cap Cer Disc .05 Mfd	1005-5039
C21	Cap Cer Disc .05 Mfd	1005-5039
C22	Cap Mica 120 PF	1001-0121
C23	Cap Mica 27 PF	1001-0270
C24	Cap Mica 270 PF	1001-0271
C25	Cap Tan 10 Mfd 20V 10%	1008-0101
C26	Cap Cer Disc .05 Mfd	1005-5039
C27	Cap Cer Disc .05 Mfd	1005-5039
C28	Cap Cer Disc .01 Mfd	1005-1039
C29	Cap Cer Disc .01 Mfd	1005-1039
C30	Cap Cer Disc .01 Mfd	1005-1039
C31	Cap Cer Disc .01 Mfd	1005-1039
C32	Cap Cer Disc .01 Mfd	1005-1039
C33	Cap Mica 10 PF	1001-0100
C34	Cap Tan 10 Mfd 20V 10%	1008-0101
C35	Cap Poly .01 Mfd 100V	1002-0011
C36	Cap Poly Carb .0027 Mfd	1006-0027
C37	Cap Poly Carb .0013 Mfd 50V	1006-0013
C38	Cap Mica 2200 PF	1001-0222
C39	Cap Tan 10 Mfd 20V 10%	1008-0101
C40	Cap Cer Disc .05 Mfd	1005-5039
C41	Cap Cer Disc .01 Mfd	1005-1039
C42	Cap Mica 10 PF	1001-0100

Model 764/765

Preselector

Assembly # 6608-1290

Ckt. Ref.	Description	TFT Stock No.
C43	Cap Mica 510 PF	1001-0511
C44	Cap Poly .01 Mfd 100V	1002-0011
C45	Cap Mica 680 PF	1001-0681
C46	Cap Mica 300 PF	1001-0301
C47	Cap Mica 2200 PF	1001-0222
C48	Cap Poly .0039 Mfd 100V	1002-0392
C49	Cap Tan 10 Mfd 10V 10%	1008-0101
C50	Cap Mica 10 PF	1001-0100
C51	Cap Mica 75 PF	1001-0750
C52	Cap Tan 10 Mfd 20V 10%	1008-0101
C53	Cap Cer Disc .05 Mfd	1005-5039
C54	Cap Mica 22 PF	1001-0220
C55	Cap Mica 51 PF	1001-0510
C56	Cap Cer Disc .05 Mfd	1005-5039
C57	Cap Tan 10 Mfd 20V	1008-0101
CR01	Dio IN3064	1281-3064
CR02	Dio IN3064	1281-3064
CR03	Dio IN3064	1281-3064
CR04	Dio IN3064	1281-3064
CR05	Dio IN3064	1281-3064
CR06	Dio IN3064	1281-3064
CR07	Dio IN3064	1281-3064
CR08	Dio IN3064	1281-3064
CR09	Dio IN3064	1281-3064
CR10	Dio IN3064	1281-3064
CR11	Dio IN3064	1281-3064
CR12	Dio IN3064	1281-3064
CR13	Dio IN3064	1281-3064
CR14	Dio IN3064	1281-3064
CR15	Dio IN281	1280-0281
CR16	Dio IN3064	1281-3064
CR17	Dio IN3064	1281-3064
CR18	Dio IN3064	1281-3064
CR19	LED HP 5082-4487 Clear	1285-4487
CR20	Dio IN3064	1281-3064
CR21	Dio IN3064	1281-3064
J01	Conn 8 Pin Molex	2250-6008
J02	Conn RF Sub Mini 50 ohm	2200-0004
J03	Plug, 10 Pin	2250-6510
J04	Plug 2 Pin	2250-6002
J05	Plug, 4 Pin	2250-6004
J06	Plug Molex 10 Pin	2250-6410
J07	Conn 12 Pin Molex	2250-6412

Model 764/765

Preselector

Assembly # 6608-1290

Ckt. Ref.	Description	TFT Stock No.
J08	Plug Molex 10 Pin	2250-6410
J09	Conn 5 Pin	2250-6405
J10	Plug, 4 Pin	2250-6004
J11	Conn 3 Pin	2250-6003
J12	Conn RF Sub Mini 50 ohm	2200-0004
J13	Plug 2 Pin	2250-6002
J14	Plug, 10 Pin	2250-6510
L01	M/L Ind Vac 42T	1577-0018
L02	Choke RF 68 UHY	1530-0682
L03	Ind Var I/H 8T	1550-0011
L04	Choke RF 180 UH	1530-0180
L05	Choke RF 82 UH	1530-0820
L06	Choke RF 15 UH	1530-0150
L07	M/L Ind-Trifilar	1501-0001
L08	M/L Ind-Trifilar	1501-0001
Q01	Xistor 2N3563	1271-3563
Q02	Xistor 2N4121	1271-4121
Q03	Xistor 2N5179	1271-5179
Q04	Xistor 2N5179	1271-5179
Q05	Xistor 2N5179	1271-5179
Q06	Xistor 2N4275	1271-4275
Q07	Xistor 2N5087	1271-5087
Q08	Xistor 2N4275	1271-4275
Q09	Xistor 2N4275	1271-4275
Q10	Xistor 2N4275	1271-4275
Q11	Xistor 2N3563	1271-3563
Q12	Xistor 2N3645	1271-3645
Q13	Xistor 2N4121	1271-4121
Q14	Xistor 2N4275	1271-4275
Q15	Xistor 2N4275	1271-4275
R01	Res Car Comp 1/4W 5% 680	1065-0680
R02	Res Car Comp 1/4W 5% 750	1065-0750
R03	Res Car Comp 1/4W 5% 180	1065-0180
R04	Res Car Comp 1/4W 5% 2.7 K	1065-2701
R05	Res Car Comp 1/4W 5% 2.7 K	1065-2701
R06	Res Car Comp 1/4W 5% 2.7 K	1065-2701
R07	Res Car Comp 1/4W 5% 680	1065-0680
R08	Res Car Comp 1/4W 5% 5.6 K	1065-5601
R09	Res Car Comp 1/4W 5% 100 K	1065-1003
R10	Res Car Comp 1/4W 5% 10 K	1065-1002
R11	Res Car Comp 1/4W 5% 3.3 K	1065-3301
R12	Res Car Comp 1/4W 5% 120	1065-0120

Model 764/765

Preselector

Assembly # 6608-1290

Ckt. Ref.	Description	TFT Stock No.
R13	Res Car Comp 1/4W 5% 100	1065-0100
R14	Res Car Comp 1/4W 5% 1K	1065-1001
R15	Res Car Comp 1/4W 5% 220	1065-0220
R16	Res Car Comp 1/4W 5% 220	1065-0220
R17	Res Car Comp 1/4W 5% 1 K	1065-1001
R18	Res Car Comp 1/4W 5% 560	1065-0560
R19	Res Car Comp 1/4W 5% 560	1065-0560
R20	Res Car Comp 1/4W 5% 4.7 K	1065-4701
R21	Res Car Comp 1/4W 5% 4.7 K	1065-4701
R22	Res Car Comp 1/4W 5% 4.7 K	1065-4701
R23	Res Car Comp 1/4W 5% 4.7 K	1065-4701
R24	Res Car Comp 1/4W 5% 4.7 K	1065-4701
R25	Res Car Comp 1/4W 5% 4.7 K	1065-4701
R26	Res Car Comp 1/4W 5% 4.7 K	1065-4701
R27	Res Car Comp 1/4W 5% 4.7 K	1065-4701
R28	Res Car Comp 1/4W 5% 4.7 K	1065-4701
R29	Res Car Comp 1/4W 5% 2.7 K	1065-2701
R30	Res Car Comp 1/4W 5% 2.2 K	1065-2201
R31	Res Car Comp 1/4W 5% 100 K	1065-1003
R32	Res Car Comp 1/4W 5% 10 K	1065-1002
R33	Res Car Comp 1/4W 5% 3.3 K	1065-3301
R34	Res Car Comp 1/4W 5% 3.9 K	1065-3901
R35	Res Car Comp 1/4W 5% 4.7 K	1065-4701
R36	Res Car Comp 1/4W 5% 470	1065-0470
R37	Res Car Comp 1/4W 5% 51	1065-0051
R38	Res Car Comp 1/4W 5% 1 K	1065-1001
R39	Res Car Comp 1/4W 5% 1 K	1065-1001
R40	Res Car Comp 1/4W 5% 220	1065-0220
R41	Res Car Comp 1/4W 5% 33 K	1065-3302
R42	Res Car Comp 1/4W 5% 1 K	1065-1001
R43	Res Car Comp 1/4W 5% 33 K	1065-3302
R44	Res Car Comp 1/4W 5% 1 K	1065-1001
R45	Res Car Comp 1/4W 5% 4.7 K	1065-4701
R46	Res Car Comp 1/4W 5% 1 K	1065-1001
R47	Res Car Comp 1/4W 5% 4.7 K	1065-4701
R48	Res Car Comp 1/4W 5% 51	1065-0051
R49	Res Car Comp 1/4W 5% 1 K	1065-1001
R50	Res Car Comp 1/4W 5% 1 K	1065-1001
R51	Res Car Comp 1/4W 5% 1 K	1065-1001
R52	Res Car Comp 1/4W 5% 1K	1065-1001
R53	Res Car Comp 1/4W 5% 10K	1065-1002
R54	Res Car Comp 1/4W 5% 1 K	1065-1001
R55	Res Car Comp 1/4W 5% 1.2 K	1065-1201
R56	Res Car Comp 1/4W 5% 220	1065-0220

Model 764/765

Preselector

Assembly # 6608-1290

Ckt. Ref.	Description	TFT Stock No.
R57	Res Car Comp 1/4W 5% 1 K	1065-1001
R58	Res Car Comp 1/4W 5% 330	1065-0330
R59	Res Car Comp 1/4W 5% 4.7 K	1065-4701
R60	Res Car Comp 1/4W 5% 4.7 K	1065-4701
R61	Res Car Comp 1/4W 5% 2.2 K	1065-2201
R62	Res Car Comp 1/4W 5% 1 K	1065-1001
R63	Res Car Comp 1/4W 5% 1 K	1065-1001
R64	Res Car Comp 1/4W 5% 10 K	1065-1002
R65	Res Mt Flm 1/2W 1% 2.87 K	1061-2871
R66	Res Mt Flm 1/8W 1% 4.75 K	1061-4751
R67	Res Mt Film 1/8W 1% 5.76 K	1061-5761
R68	Res Car Comp 1/4W 5% 220	1065-0220
R69	Res Car Comp 1/4W 5% 1.5 K	1065-1501
R70	Res Car Comp 1/4W 5% 12 K	1065-1202
R71	Res Car Comp 1/4W 5% 100	1065-0100
R72	Res Car Comp 1/4W 5% 100	1065-0100
R73	Res Mt Flm 1/8W 1% 21.0 K	1061-2102
R74	Res Mt Flm 1/8W 1% 10 K	1061-1002
R75	Res Mt Flm 1/8W 1% 11.3 K	1061-1132
R76	Res Car Comp 1/4W 5% 820	1065-0820
R77	Res Car Comp 1/4W 5% 2.2 K	1065-2201
R78	Res Mt Flm 1/8W 1% 3.74 K	1061-3741
R79	Res Mt Flm 1/8W 1% 23.7 K	1061-2372
R80	Res Mt Flm 1/8W 1% 7.5 K	1061-7501
R81	Res Mt Flm 1/8W 1% 107 K	1061-1073
R82	Res Mt Flm 1/8W 1% 10 K	1061-1002
R83	Res Mt Flm 1/8W 1% 1 K	1061-1001
R84	Res Mt Flm 1/8W 1% 10.2 K	1061-1022
R85	Res Car Comp 1/4W 5% 10 K	1065-1002
R86	Res Car Comp 1/4W 5% 4.7 K	1065-4701
R87	Res Car Comp 1/4W 5% 6.8 K	1065-6801
R88	Res Car Comp 1/4W 5% 1.5 K	1065-1501
R89	Res Car Comp 1/4W 5% 3.3 K	1065-3301
R90	Res Car Comp 1/4W 5% 100	1065-0100
R91	Res Car Comp 1/4W 5% 5.6 K	1065-5601
R93	Res Car Comp 1/4W 5% 270	1065-0270
R94	Res Car Comp 1/4W 5% 330	1065-0330
R95	Res Car Comp 1/4W 5% 1 K	1065-1001
R96	Res Car Comp 1/4W 5% 8.2 K	1065-8201
R97	Res Car Comp 1/4W 5% 100	1065-0100
S1	Switch Thumbwheel 74	1875-5037
U01	I/C MC 10135L	1100-1135



Model 764/765

Preselector

Assembly # 6608-1290

Ckt. Ref.	Description	TFT Stock No.
U02	I/C MC 10135L	1100-1135
U03	I/C SN74LS00N	1101-7400
U04	I/C SN74LS00N	1101-7400
U05	I/C SN74LS10N	1101-7410
U06	I/C SN74LS00N	1101-7400
U07	I/C SN74LS10N	1101-7410
U08	I/C SN74LS196N	1101-7496
U09	I/C SN74LS196N	1101-7496
U10	I/C SN74LS196N	1101-7496
U11	I/C SN74LS196N	1101-7496
U12	I/C SN74LS90N	1101-7490
U13	I/C SN74LS90N	1101-7490
U14	I/C DM74LS76N	1101-7476
U15	I/C SN74LS90N	1101-7490
U16	1/6 LM 741CN	1100-0741
U17	I/C UA796HG	1100-0796
U18	I/C LM710CN	1100-0710
U19	I/C SN74LS00N	1101-7400
U20	I/C SN74LS10N	1101-7410
U21	I/C DM74LS76N	1101-7476
U22	I/C LM302	1100-0302
U23	I/C LM 741CN	1100-0741
U24	I/C LM 741CN	1100-0741
U25	I/C LM 741CN	1100-0741
Z1	Tuner FM XM 307	4500-0307
	* Filt 10.7 MHz	1052-0001
	Xistor Pad 23 Pin	1150-0003
	Socket, I/C 8 Pin	2250-1008
	Socket, I/C 14 Pin	2250-1014
	Socket, I/C 16 Pin	2250-1016
	Gorler Tuner Assy 764 765	5102-1930
	PCB Preselector 764	1600-1290 REV
	* NOTE: REPLACED W/ XTAL. FILTER FROM HEATH AR-15 RCVR, HEATH P/N 404-383	

If You Didn't Get This From My Site,  
Then It Was Stolen From...  
[www.SteamPoweredRadio.Com](http://www.SteamPoweredRadio.Com)

NEXT ASSY		USED ON		REVISIONS			
ITEM NO.	QTY	SYM	DATE	DESCRIPTION	DR	CHK	AUTH DATE
		A	REL 75				

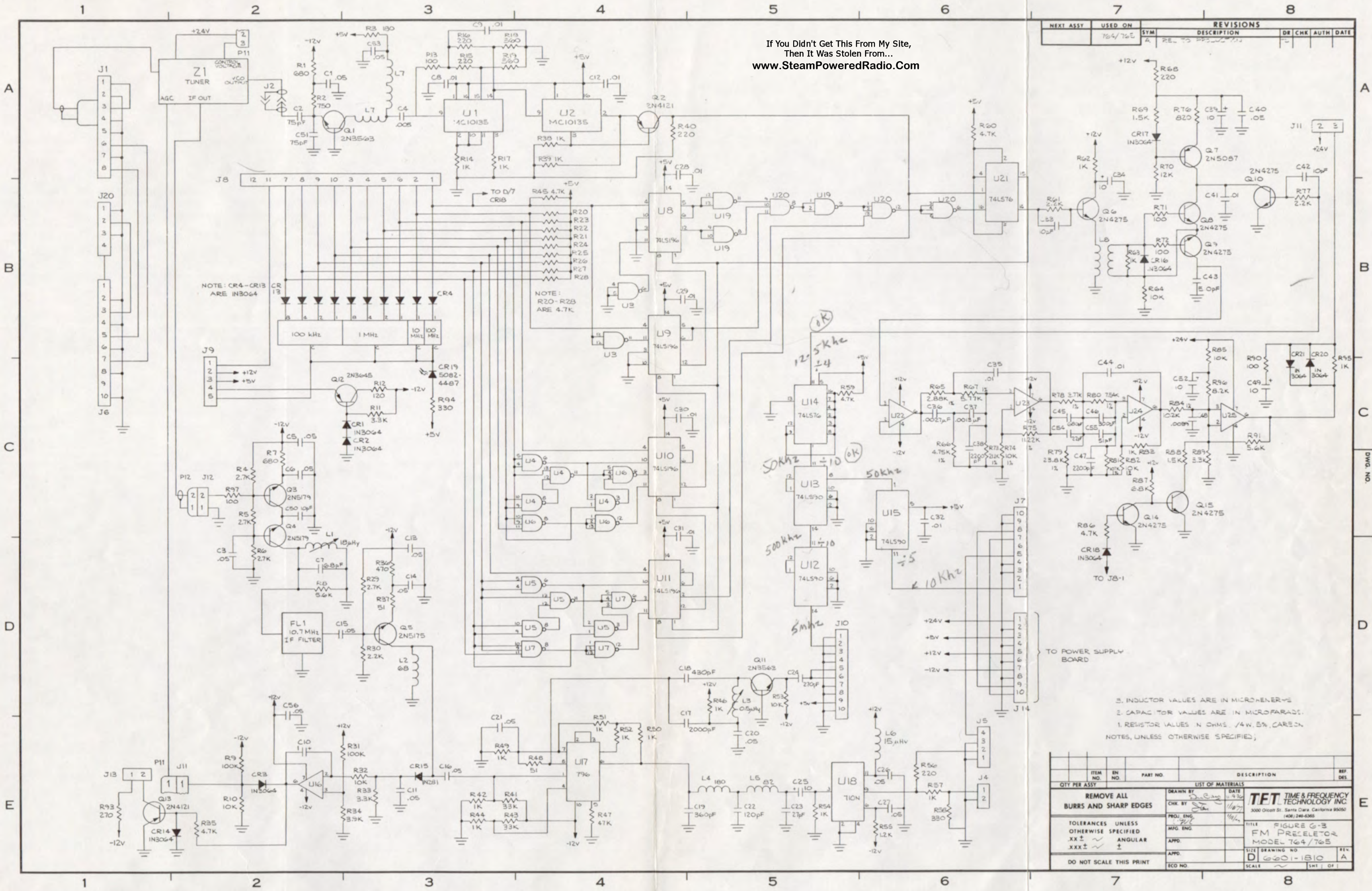

ITEM NO.	QTY	SYM	DESCRIPTION	REF DES.

  

REMOVE ALL BURRS AND SHARP EDGES		LIST OF MATERIALS	
DATE	DATE	DATE	DATE
11/93	11/93	11/93	11/93
11/97	11/97	11/97	11/97

TOLERANCES UNLESS OTHERWISE SPECIFIED		TITLE	
XX ±	ANGULAR	FM PRESELECTOR MODEL 764/765	
XXX ±	±	SIZE	REV
		D 6601-1810	A
DO NOT SCALE THIS PRINT	SCALE	1/8" = 1"	SHT. OF

NEXT ASSY	USED ON	REVISIONS					
5102-1930	764	SYM	DESCRIPTION	DR	CHK	AUTH	DATE
		A	REL TO PROD.				

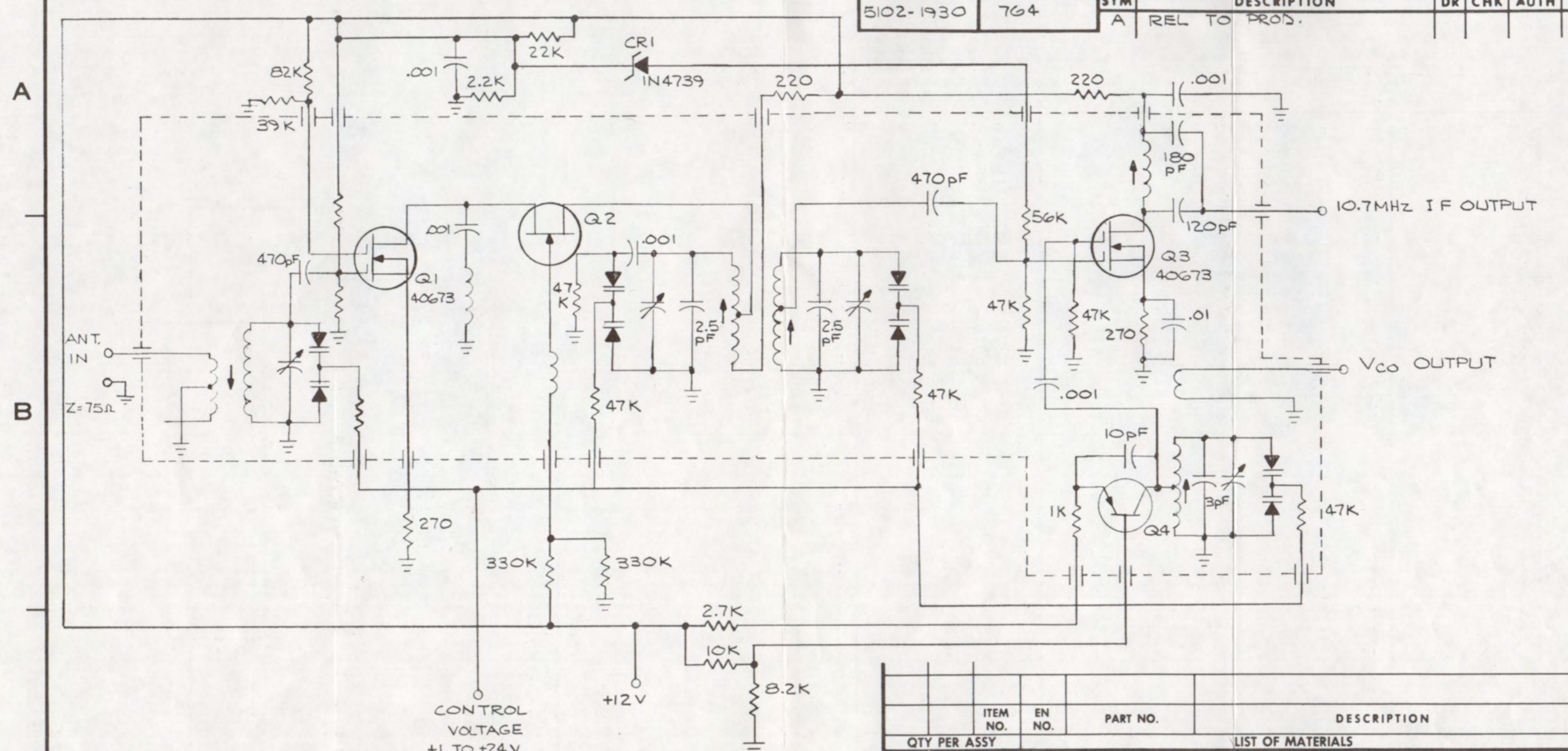

CONTROL VOLTAGE +1 TO +24V

+12V

8.2K

2. CAPACITOR VALUES ARE MICROFARADS  
 1. RESISTOR VALUES ARE OHMS, 1/4W, 5%  
 NOTES, UNLESS OTHERWISE SPECIFIED;

ITEM NO.	EN NO.	PART NO.	DESCRIPTION	REF. DES.
QTY PER ASSY				
LIST OF MATERIALS				
REMOVE ALL BURRS AND SHARP EDGES			DRAWN BY: <i>[Signature]</i> CHK. BY: <i>[Signature]</i> PROJ. ENG.: <i>[Signature]</i> MFG. ENG.: APPD.: APPD.: ECO NO.:	DATE: 1/18/77 DATE: 1/11/77 DATE: 1/11/77
TOLERANCES UNLESS OTHERWISE SPECIFIED .XX ± ~ .XXX ± ~			ANGULAR ± ±	
DO NOT SCALE THIS PRINT			TITLE: Z1 TUNER ASSY FIGURE 6-4 SIZE: B DRAWING NO.: 6601-1900 REV.: A SCALE: ~ SHT. 1 OF 1	

If You Didn't Get This From My Site,  
 Then It Was Stolen From...  
[www.SteamPoweredRadio.Com](http://www.SteamPoweredRadio.Com)

Model 765

PC BD Std 5 MHz Osc

Assembly # 6608-1180

Ckt. Ref.	Description	TFT Stock No.
C1	Cap Cer Disc .05 Mfd	1005-5039
C2	Cap Mica 33 PF	1001-0330
C3	Cap Mica 1000 PF	1001-0102
C4	Cap Mica 470 PF	1001-0471
L1	Choke R F 15 UH	1530-0150
P10	Socket 10 Pin	2250-5210
Q1	Xistor 2N3563	1271-3563
R1	Res Car Comp 1/4W 5% 3.3k	1065-3301
R2	Res Car Comp 1/4W 5% 390	1065-0390
R3	Res Car Comp 1/4W 5% 1.5k	1065-1501
R4	Res Car Comp 1/4W 5% 180	1065-0180
Y1	Crystal 5.0 MHz	2400-0502
	Xistor Socket 3 pin	1150-0001
	PC Board 765 5 MHz Osc	1600-1180 REVA

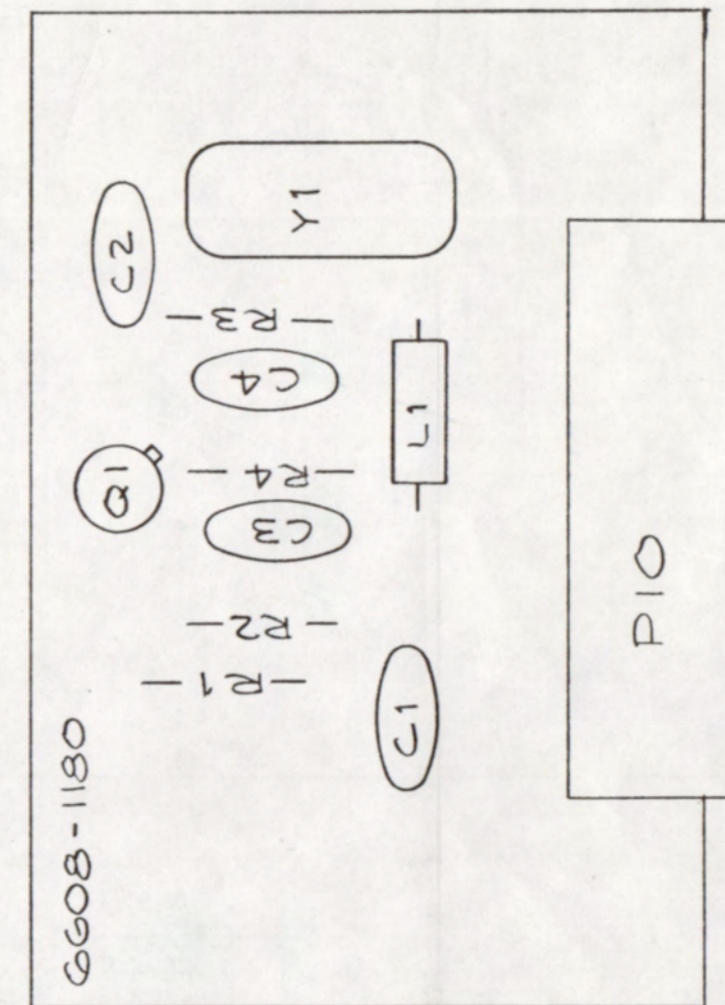

1

2

3

DWG. NO.  
6601-1580

4

5

NEXT ASSY	USED ON	REVISIONS					
		SYM	DESCRIPTION	DR	CHK	AUTH	DATE
6608-1180	755	A	RELEASED PER ECO 324	RG			4-9-76
6608-1180	765	B	ADDED P10-5,6	TD			1-14-77

A

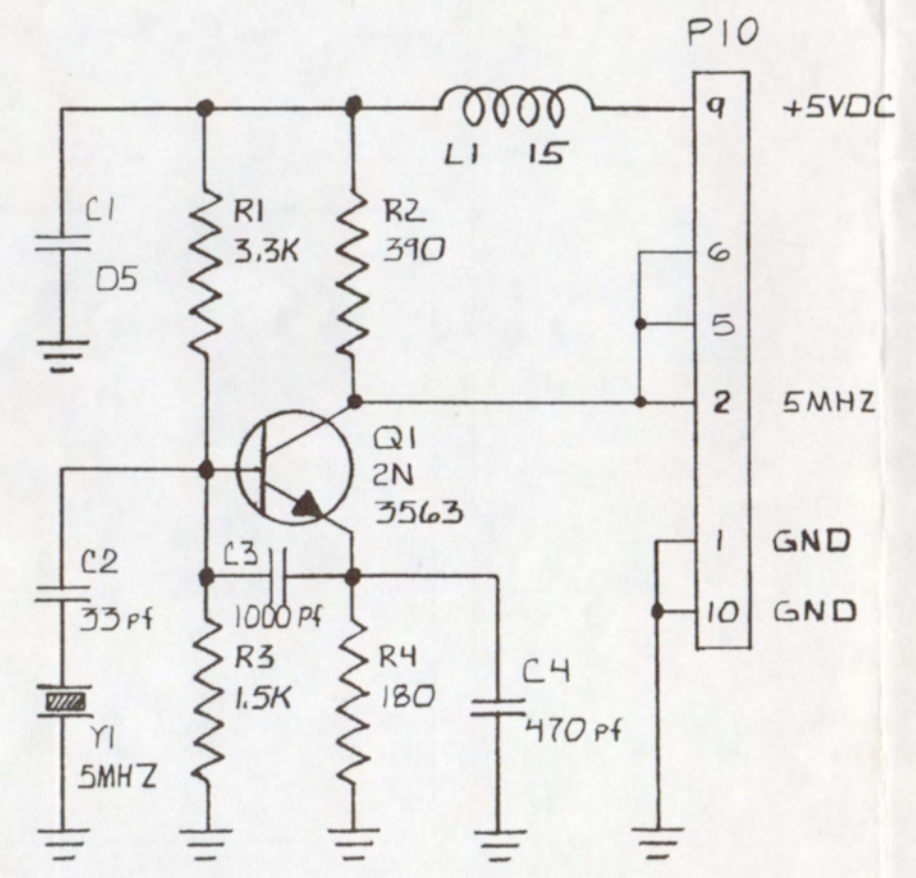

B

- NOTES; UNLESS OTHERWISE SPECIFIED:
1. RESISTORS - VALUES IN OHMS +5%, 1/4 WATT.
  2. CAPACITORS - VALUES IN MICROFARADS.
  3. INDUCTORS - VALUES IN MICROHENRYS +10%
  4. \*FACTORY SELECT VALUE. TYPICAL VALUE SHOWN.
  5. VOLTAGES ARE DC CONDITIONS.

C

If You Didn't Get This From My Site,  
Then It Was Stolen From...  
[www.SteamPoweredRadio.Com](http://www.SteamPoweredRadio.Com)

ITEM NO.	EN NO.	PART NO.	DESCRIPTION	REF. DES.
QTY PER ASSY				
LIST OF MATERIALS				
REMOVE ALL BURRS AND SHARP EDGES			DRAWN BY <i>RAM</i>	DATE 3-18-76
TOLERANCES UNLESS OTHERWISE SPECIFIED			CHK. BY <i>Stau</i>	DATE 1/18/77
.XX ±			PROJ. ENG. <i>C. J. E.</i>	DATE 1/14/77
.XXX ±			MFG. ENG.	
ANGULAR ±			APPD.	
DO NOT SCALE THIS PRINT			APPD.	
			ECO NO.	
			SCALE	SHT. 1 OF 1

**TFT** TIME & FREQUENCY TECHNOLOGY INC.  
3000 Olcott St., Santa Clara, California 95050  
(408) 246-6365

TITLE FIGURE 6-5  
STANDARD 5MHZ  
OSCILLATOR

SIZE B DRAWING NO. 6601-1580 REV. B

A

B

C

1

2

3

4

5

Model 764

PC BD TCXO 5 MHz Osc

Assembly # 6608-1170

Ckt. Ref.	Description	TFT Stock No.
C1	Cap Cer Disc .2 Mfd	1005-2029
J12	Plug 2 Pin	2250-6002
P10	Socket 10 Pin	2250-5210
R1	Res Car Comp 1/4W 5% 2.2K	1065-2201
R2	Res Car Comp 1/4W 5% 2.2K	1065-2201
U1	I/C SN7472N	1100-7472
	Socket I/C 14 Pin	2250-1014
	Crystal Osc TCXO 10 MHz	2450-1002
	PC Board 764 TCXO 5 MHz Osc	1600-1170 REVC

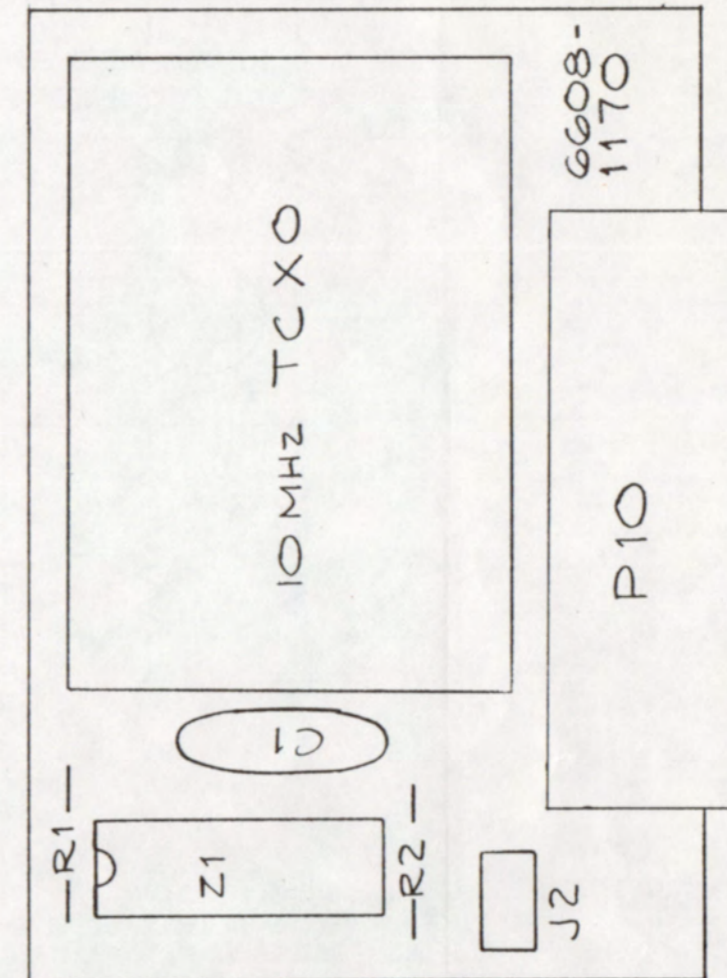

1

2

3

DWG. NO.  
6601-1590

4

5

NEXT ASSY	USED ON	REVISIONS					
		SYM	DESCRIPTION	DR	CHK	AUTH	DATE
6608-1170	754	A	RELEASED PER ECO 324	RG			4-9-76
	764	B	REV PER ECO 329	TD			6-16-76
		C	ADDED PIO-5,6	TD			1-4-77

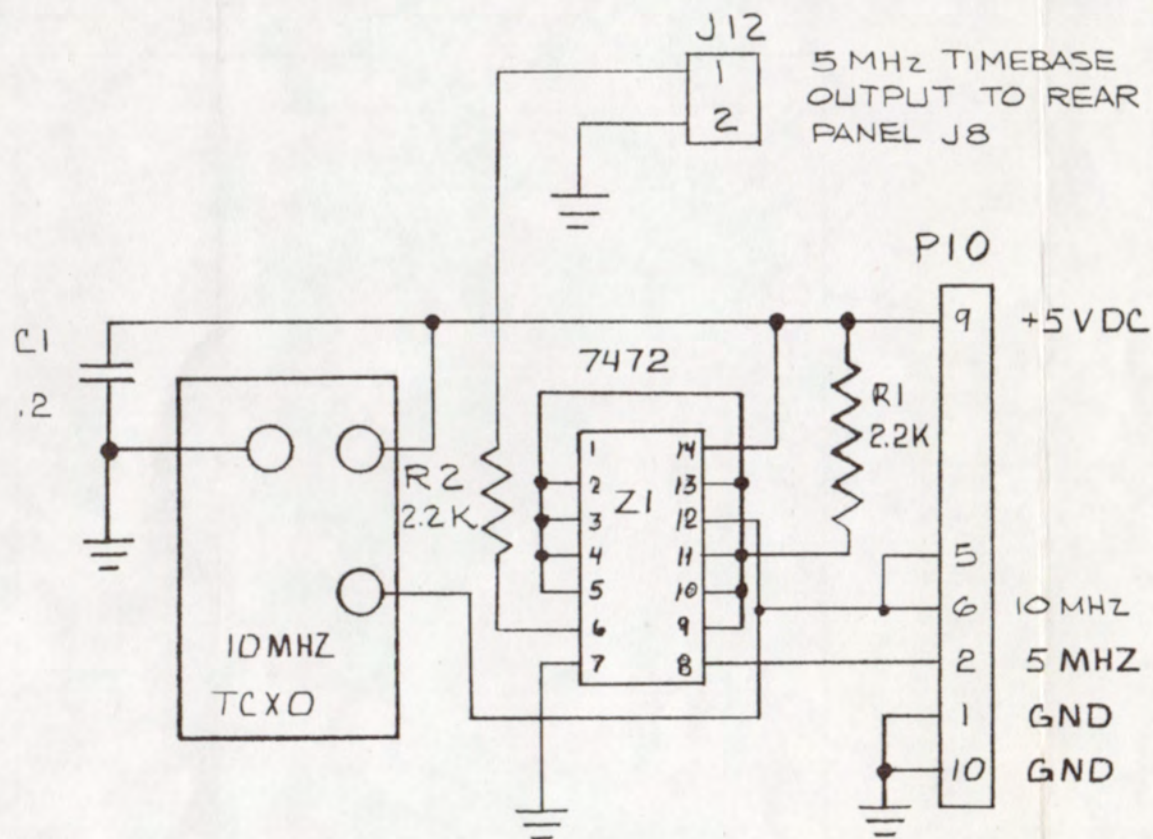

- NOTES; UNLESS OTHERWISE SPECIFIED:
1. RESISTORS - VALUES IN OHMS +5%, 1/4 WATT.
  2. CAPACITORS - VALUES IN MICROFARADS
  3. INDUCTORS - VALUES IN MICROHENRYS +10%
  4. \*FACTORY SELECT VALUE. TYPICAL VALUE SHOWN.
  5. VOLTAGES ARE DC CONDITIONS.

ITEM NO.	EN NO.	PART NO.	DESCRIPTION	REF. DES.
QTY PER ASSY				
LIST OF MATERIALS				
REMOVE ALL BURRS AND SHARP EDGES			DRAWN BY <i>GRAM</i> DATE 3-18-76 CHK. BY <i>Fau</i> 1/18/77 PROJ. ENG. <i>CNE</i> 1/18/77 MFG. ENG. APPD. APPD. ECO NO.	<b>TET</b> TIME & FREQUENCY TECHNOLOGY INC. 3000 Olcott St., Santa Clara, California 95050 (408) 246-6365 TITLE FIGURE 6-6 TCXO 5MHZ OSCILLATOR
TOLERANCES UNLESS OTHERWISE SPECIFIED			SIZE B	REV. C
.XX ±			DRAWING NO. 6601-1590	
.XXX ±			SCALE	SHT. / OF /
DO NOT SCALE THIS PRINT				

1

2

3

4

5

Model 764

Thumbwheel Switch Board

Assembly # 6608-1320

Ckt. Ref.	Description	TFT Stock No.
CR1	LED HP 5082-4487 Clear	1285-4487
CR2	Dio IN3064	1281-3064
CR3	Dio IN3064	1281-3064
CR4	Dio IN3064	1281-3064
CR5	Dio IN3064	1281-3064
CR6	Dio IN3064	1281-3064
CR7	Dio IN3064	1281-3064
CR8	Dio IN3064	1281-3064
CR9	Dio IN3064	1281-3064
CR10	Dio IN3064	1281-3064
CR11	Dio IN3064	1281-3064
J8	Socket 10 Pin	2250-5210
J9	Socket Molex 5 Pin	2250-5205
R1	Res Car Comp 1/4W 5% 330	1065-0330
S1	Switch Thumbwheel 764	1875-5037
	PCB Thumbwheel SW 764	1600-1320 REVA

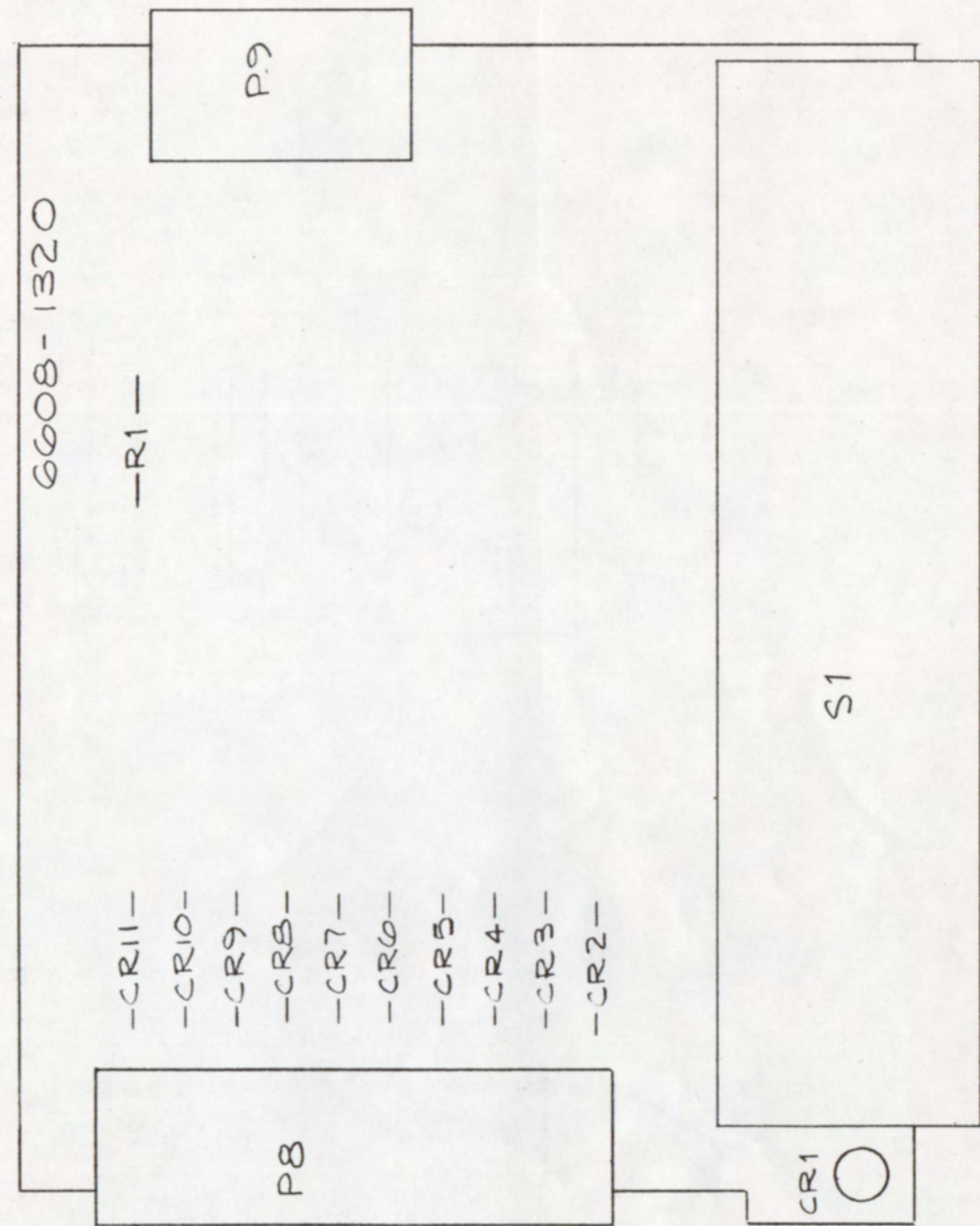



1

2

3

DWG. NO.

4

5

NEXT ASSY		USED ON		REVISIONS					
6601-1320		764		SYM	DESCRIPTION	DR	CHK	AUTH	DATE
				A	REL TO PRODUCTION	TD			11-18-76

A

P8A,B,C

- 10
- 9
- 8
- 7
- 6
- 5
- 4
- 3
- 2
- 1

CR2 CR3 CR4 CR5 CR6 CR7 CR8 CR9 CR10 CR11

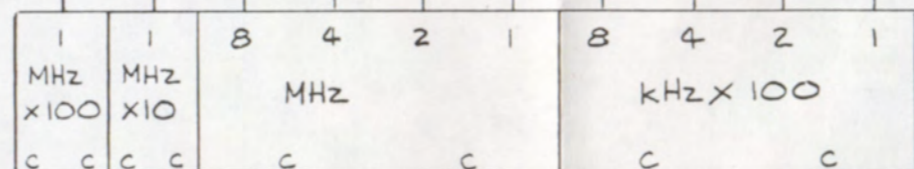

NOTE: CR2-CR11 ARE IN3064

S1

B

P9A,B,C

- 5
- 4
- 3
- 2
- 1

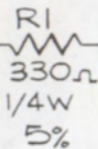

CR1 HP 5082-4487

C

ITEM NO.	EN NO.	PART NO.	DESCRIPTION	REF. DES.
QTY PER ASSY				
LIST OF MATERIALS				
REMOVE ALL BURRS AND SHARP EDGES			DRAWN BY <i>DuBay</i> DATE 11-18-76 CHK. BY <i>Jan</i> 1/18/77 PROJ. ENG. <i>ME/E</i> 1/19/77 MFG. ENG. APPD. APPD. ECO NO.	<b>TFT</b> TIME & FREQUENCY TECHNOLOGY INC. 3000 Olcott St., Santa Clara, California 95050 (408) 246-6365
TOLERANCES UNLESS OTHERWISE SPECIFIED			TITLE	
.XX ± ~ ANGULAR			FIGURE 6-7	
.XXX ± ~ ±			SCHEMATIC: THUMBWHEEL SW.	
DO NOT SCALE THIS PRINT			SIZE	DRAWING NO.
			B	6601-1830
			SCALE ~	REV. A
			SHT. 1 OF 1	

If You Didn't Get This From My Site,  
Then It Was Stolen From...  
www.SteamPoweredRadio.Com

1

2

3

4

5

Model 764

764 Channel Selector Bd

Assembly # 6608-1300

Ckt. Ref.	Description	TFT Stock No.
C1	Cap Elect 1 Mfd 25V 10%	1010-0010
C2	Cap Elect 1 Mfd 25V 10%	1010-0010
C3	Cap Mica 1000 PF	1001-0102
C4	Cap Cer Disc .02 Mfd	1005-2039
C5	Cap Mica 390 PF	1001-0391
C6	Cap Cer Disc .2 Mfd	1005-2029
J15	Plug 2 Pin	2250-6002
J16	Conn 12 Pin Molex	2250-6012
J9A	Plug Molex 5 Pin	2250-6505
J9B	Plug Molex 5 Pin	2250-6505
J9C	Plug Molex 5 Pin	2250-6505
P6	Socket 10 Pin	2250-5210
P9	Socket Molex 5 Pin	2250-5205
Q1	Xistor 2N3643	1271-3643
Q2	Xistor 2N4275	1271-4275
Q3	Xistor 2N4275	1271-4275
Q4	Xistor 2N4275	1271-4275
RU1	Res Car Comp 1/4W 5% 6.8 K	1065-6801
R2	Res Car Comp 1/4W 5% 1 K	1065-1001
R3	Res Car Comp 1/4W 5% 1 K	1065-1001
R4	Res Car Comp 1/4W 5% 4.7 K	1065-4701
R5	Res Var PC Mt 2K 10T	1069-2001
R6	Res Car Comp 1/4W 5% 2.7 K	1065-2701
R7	Res Car Comp 1/4W 5% 1 K	1065-1001
R8	Res Car Comp 1/4W 5% 4.7 K	1065-4701
R9	Res Car Comp 1/4W 5% 1 K	1065-1001
R10	Res Car Comp 1/4W 5% 470	1065-0470
R11	Res Car Comp 1/4W 5% 4.7 K	1065-4701
R12	Res Car Comp 1/4W 5% 4.7 K	1065-4701
R13	Res Car Comp 1/4W 5% 4.7 K	1065-4701
R14	Res Car Comp 1/4W 5% 10 K	1065-1002
S1	Switch Assy 4 Stat Pushbut	1850-1004
U1	I/C NE565A	1100-0565
U2	I/C SN74LS90N	1101-7490
	Cap P/B Switch	1850-0007
	PCB CH Selector 764	1600-1300 REVA

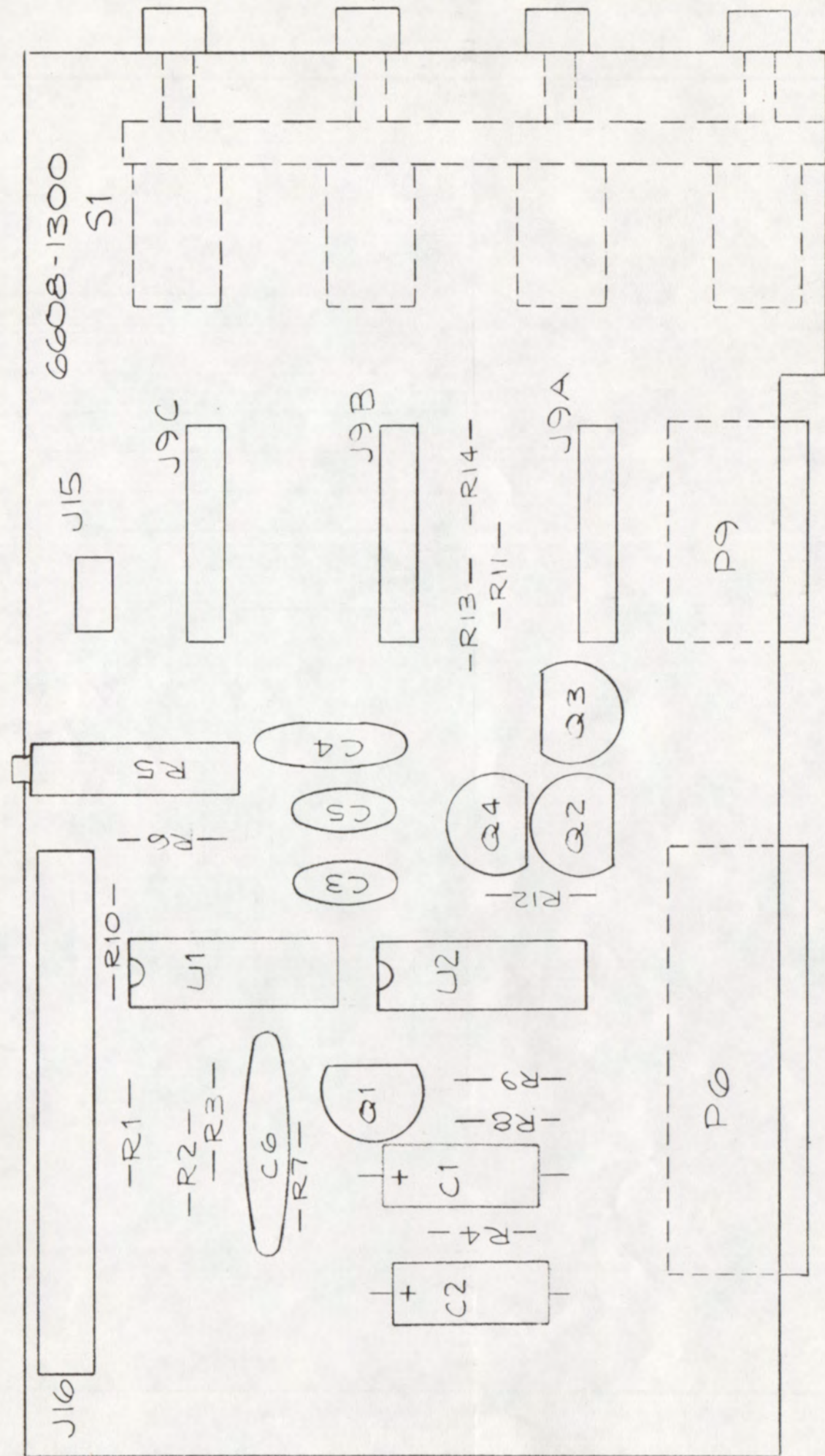

NEXT ASSY		USED ON		REVISIONS				
SYM	DESCRIPTION	DR	CHK	AUTH	DATE			
6608-1300	764	A	REL PER	ECO	353			10-22-76

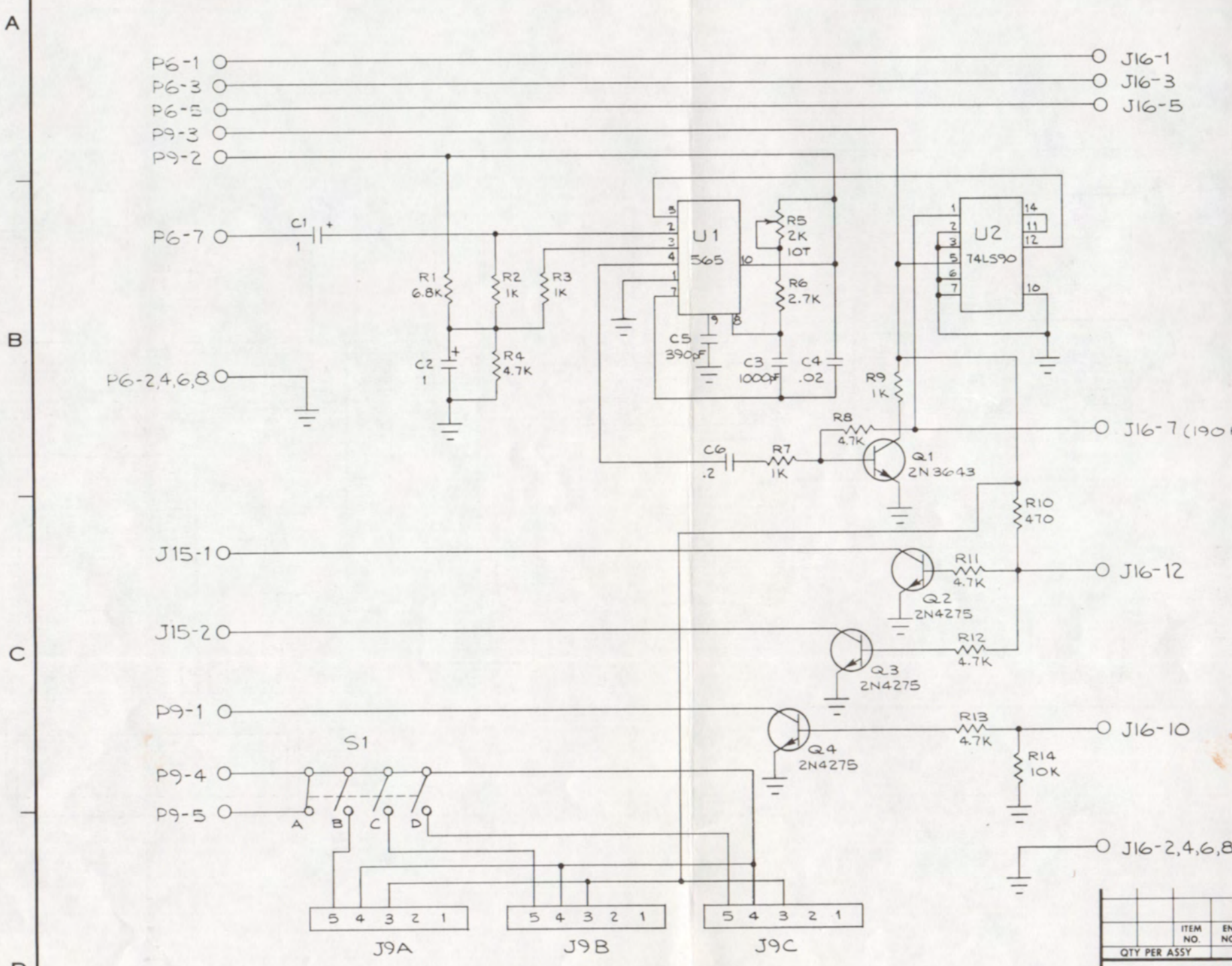

2. CAPACITOR VALUES ARE IN MICROFARADS.  
 1. RESISTOR VALUES ARE IN OHMS, 1/4W, 5%  
 NOTES, UNLESS OTHERWISE SPECIFIED;

QTY PER ASSY	ITEM NO.	EN NO.	PART NO.	DESCRIPTION	REF. DES.
LIST OF MATERIALS					
<b>REMOVE ALL BURRS AND SHARP EDGES</b>					
DRAWN BY		DATE		<b>TET TIME &amp; FREQUENCY TECHNOLOGY INC</b> 3000 Olcott St., Santa Clara, California 95050 (408) 246-5365 TITLE: FIG: G-8 CHANNEL SELECTOR 19KHZ X 10	
CHK. BY		DATE			
PROJ. ENG.		DATE			
MFG. ENG.		DATE			
APPD.		APPD.		SIZE DRAWING NO	
APPD.		APPD.		C 6601-1790	
ECO NO.		ECO NO.		SCALE	
				SHT 1 OF 1	

If You Didn't Get This From My Site,  
 Then It Was Stolen From...  
[www.SteamPoweredRadio.Com](http://www.SteamPoweredRadio.Com)

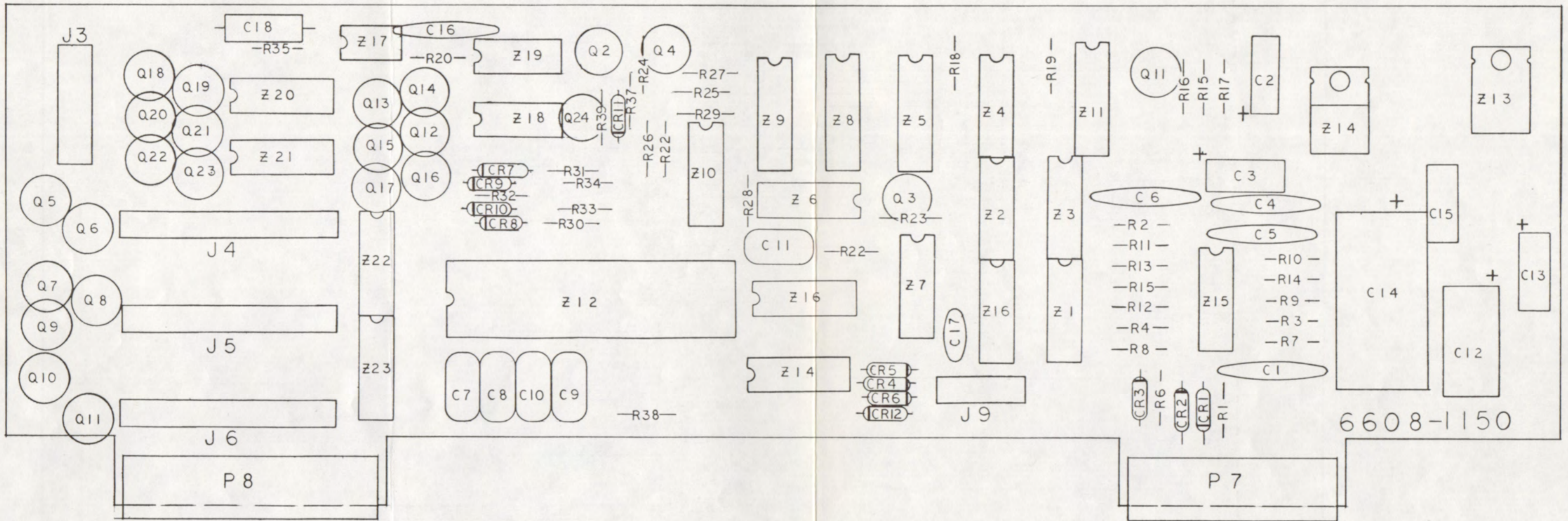

Model 764

PC Bd Counter

Assembly # 6608-1310

Ckt. Ref.	Description	TFT Stock No.
C1	Cap Cer Disc .2 Mfd	1005-2029
C2	Cap Elect 15 Mfd 25V	1010-0150
C3	Cap Elect 15 Mfd 25V	1010-0150
C4	Cap Cer Disc .2 Mfd	1005-2029
C5	Cap Cer Disc .2 Mfd	1005-2029
C6	Cap Cer Disc .2 Mfd	1005-2029
C7	Cap Mica 150 PF	1001-0151
C8	Cap Mica 150 PF	1001-0151
C9	Cap Mica 150 PF	1001-0151
C10	Cap Mica 150 PF	1001-0151
C11	Cap Mica 470 PF	1001-0471
C12	Cap Elect 100 Mfd 16V	1010-0101
C13	Cap Tan 10 Mfd 20V 10%	1008-0101
C14	Cap Elect 1000 Mfd 15V	1010-0102
C15	Cap Tan 10 Mfd 20V 10%	1008-0101
C16	Cap Cer Disc .2 Mfd	1005-2029
C17	Cap Cer Disc .05 Mfd	1005-5039
C18	Cap Tan 10 Mfd 20V 10%	1008-0101
CR1	Dio IN281	1280-0281
CR2	Dio IN281	1280-0281
CR3	Dio ZNR IN4735	1283-4735
CR4	Dio IN3064	1281-3064
CR5	Dio IN3064	1281-3064
CR6	Dio IN3064	1281-3064
CR7	Dio IN3064	1281-3064
CR9	Dio IN3064	1281-3064
CR10	Dio IN3064	1281-3064
CR11	Dio IN3064	1281-3064
CR12	Dio ZNR IN4744	1283-4744
Q1	Xistor 2N3643	1271-3643
Q2	Xistor 2N4275	1271-4275
Q3	Xistor 2N4275	1271-4275
Q4	Xistor 2N4275	1271-4275
Q5	Xistor 2N3643	1271-3643
Q6	Xistor 2N3643	1271-3643
Q7	Xistor 2N3643	1271-3643
Q8	Xistor 2N3643	1271-3643
Q9	Xistor 2N3643	1271-3643
Q10	Xistor 2N3643	1271-3643
Q11	Xistor 2N3643	1271-3643
Q12	Xistor 2N3643	1271-3643
Q13	Xistor 2N3643	1271-3643
Q14	Xistor 2N3643	1271-3643
Q15	Xistor 2N3643	1271-3643

Model 764

PC Bd Counter

Assembly # 6608-1310

Ckt. Ref.	Description	TFT Stock No.
Q16	Xistor 2N3643	1271-3643
Q17	Xistor 2N3643	1271-3643
Q18	Xistor 2N3643	1271-3643
Q19	Xistor 2N3643	1271-3643
Q20	Xistor 2N3643	1271-3643
Q21	Xistor 2N3643	1271-3643
Q22	Xistor 2N3643	1271-3645
Q23	Xistor 2N3643	1271-3645
Q24	Xistor 2N4275	1271-4275
R1	Res Car Comp 1/4W 5% 560	1065-0560
R2	Res Car Comp 1/4W 5% 560	1065-0560
R3	Res Car Comp 1/4W 5% 470	1065-0470
R4	Res Car Comp 1/4W 5% 470	1065-0470
R5	Res Car Comp 1/4W 5% 2.2K	1065-2201
R6	Res Car Comp 1/4W 5% 3.9K	1065-3901
R7	Res Car Comp 1/4W 5% 1K	1065-1001
R8	Res Car Comp 1/4W 5% 1K	1065-1001
R9	Res Car Comp 1/4W 5% 3.3K	1065-3301
R10	Res Car Comp 1/4W 5% 470	1065-0470
R11	Res Car Comp 1/4W 5% 1K	1065-1001
R12	Res Car Comp 1/4W 5% 1K	1065-1001
R13	Res Car Comp 1/4W 5% 1K	1065-1001
R14	Res Car Comp 1/4W 5% 1K	1065-1001
R15	Res Car Comp 1/4W 5% 1K	1065-1001
R16	Res Car Comp 1/4W 5% 10K	1065-1002
R17	Res Car Comp 1/4W 5% 1K	1065-1001
R18	Res Car Comp 1/4W 5% 4.7K	1065-4701
R19	Res Car Comp 1/4W 5% 4.7K	1065-4701
R20	Res Car Comp 1/4W 5% 2.4MEG	1065-2404
R21	Res Car Comp 1/4W 5% 10K	1065-1002
R22	Res Car Comp 1/4W 5% 4.7K	1065-4701
R23	Res Car Comp 1/4W 5% 2.2K	1065-2201
R24	Res Car Comp 1/4W 5% 4.7K	1065-4701
R25	Res Car Comp 1/4W 5% 10K	1065-1002
R26	Res Car Comp 1/4W 5% 10K	1065-1002
R27	Res Car Comp 1/4W 5% 2.2K	1065-2201
R28	Res Car Comp 1/4W 5% 4.7K	1065-4701
R29	Res Car Comp 1/4W 5% 10K	1065-1002
R30	Res Car Comp 1/4W 5% 22K	1065-2202
R31	Res Car Comp 1/4W 5% 22K	1065-2202
R32	Res Car Comp 1/4W 5% 22K	1065-2202
R35	Res Car Comp 1/4W 5% 470	1065-0470
R37	Res Car Comp 1/4W 5% 10K	1065-1002

Model 764

PC Bd Counter

Assembly # 6608-1310

Ckt. Ref.	Description	TFT Stock No.
R38	Res Car Comp 1/4W 5% 100K	1065-1003
R39	Res Car Comp 1/4W 5% 390	1065-0390
Z1	I/C SN74LS90N	1101-7490
Z2	I/C SN74LS90N	1001-7490
Z3	I/C SN74LS90N	1101-7490
Z4	I/C SN74LS90N	1001-7490
Z5	I/C DM74LS76N	1101-7476
Z6	I/C SN74LS00PC	1101-7400
Z7	I/C SN74LS00PC	1101-7400
Z8	I/C DM74LS76N	1101-7476
Z9	I/C DM74LS76N	1101-7476
Z10	I/C DM74LS01N	1101-7401
Z11	I/C DM74LS76N	1101-7476
Z12	I/C MK 50395N	1100-5039
Z13	I/C REG 1/2 Amp +12V	1100-4212
Z14	I/C REG 1/2 Amp +5V	1100-4105
Z15	I/C CA3054	1100-3054
Z16	I/C SN74LS20N	1101-7420
Z17	I/C LM555CN	1100-0555
Z18	Resistor Network 10K	1073-1002
Z19	Resistor Network 10K	1073-1002
Z20	Resistor Network 1.5K	1073-1501
Z21	Resistor Network 1.5K	1073-1501
Z22	Resistor Network 4.7K	1073-4701
Z23	Resistor Network 4.7K	1073-4701
	Xistor Socket 3 Pin	1150-0001
	Screw 4-40X 1/4	2104-0001
	Nut Kep 4-40	2111-0001
	Socket 18 Pin	2250-0018
	Socket, I/C 8 Pin	2250-1008
	Socket, I/C 14 Pin	2250-1014
	Socket, I/C 16 Pin	2250-1016
	Socket, I/C 40 Pin	2250-1040
	Socket, 10 Pin	2250-5210
	Socket, 12 Pin	2250-5212
	Plug, 4 Pin	2250-6004
	Plug, 10 Pin	2250-6510
	P.C. Bd	1600-1310 REVC

NEXT ASSY		USED ON		REVISIONS			
SYM	DESCRIPTION	DR	CHK	AUTH	DATE		
6605-115	764	A				RELEASED PER ECO	25

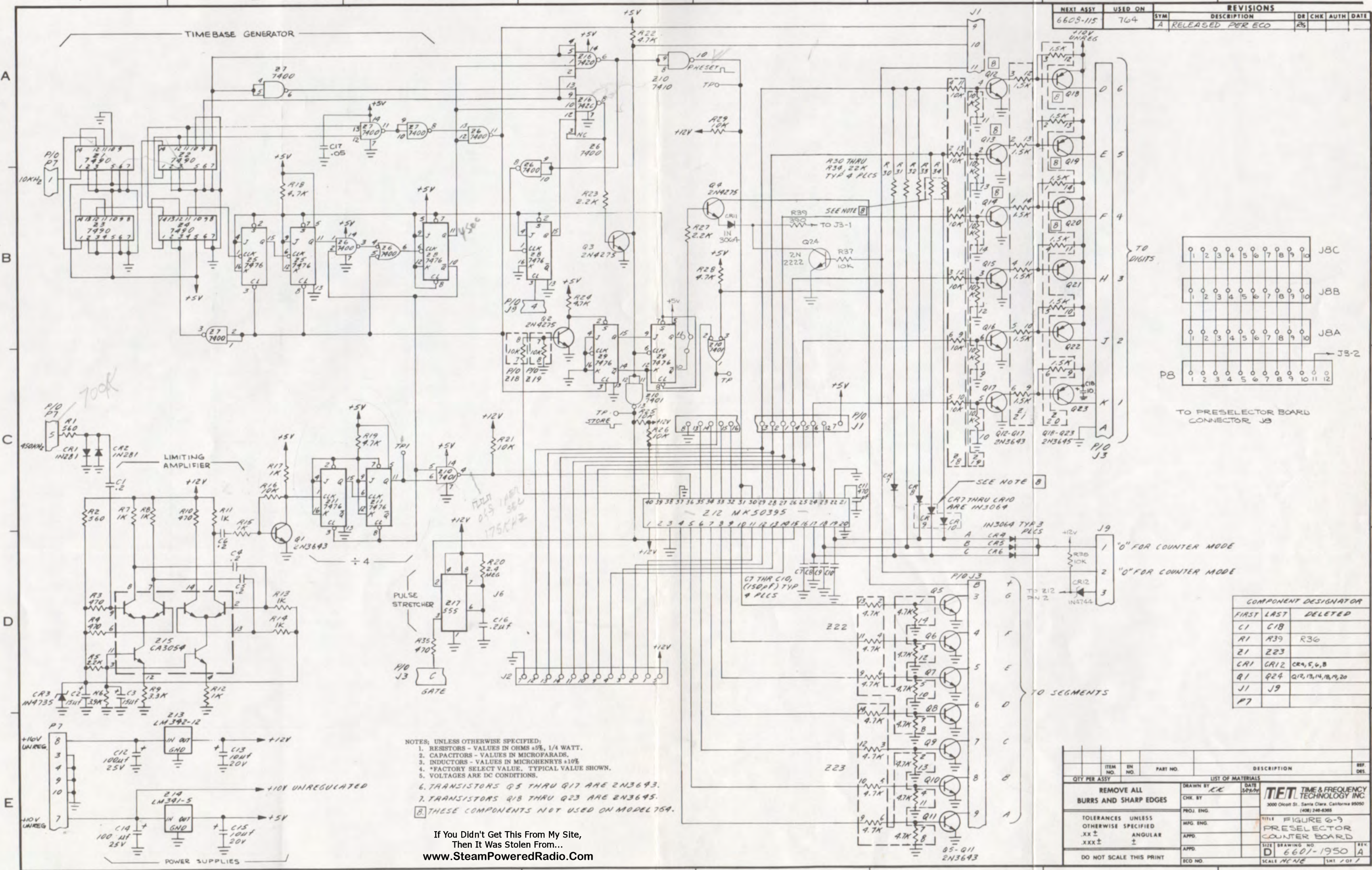

- NOTES: UNLESS OTHERWISE SPECIFIED:
1. RESISTORS - VALUES IN OHMS  $\pm 5\%$ , 1/4 WATT.
  2. CAPACITORS - VALUES IN MICROFARADS.
  3. INDUCTORS - VALUES IN MICROHENRYS  $\pm 10\%$
  4. \*FACTORY SELECT VALUE, TYPICAL VALUE SHOWN.
  5. VOLTAGES ARE DC CONDITIONS.
  6. TRANSISTORS Q5 THRU Q17 ARE 2N3643.
  7. TRANSISTORS Q18 THRU Q23 ARE 2N3645.
  8. THESE COMPONENTS NOT USED ON MODEL 754.

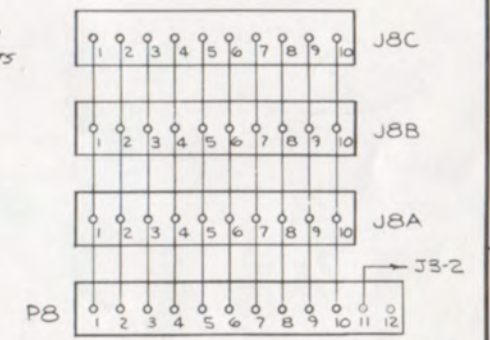

TO PRESELECTOR BOARD CONNECTOR J3

COMPONENT DESIGNATOR		
FIRST	LAST	DELETED
C1	C18	
R1	R39	R36
Z1	Z23	
CR1	CR12	CR4,5,6,8
Q1	Q24	Q12,13,14,19,20
J1	J9	
P7		

ITEM NO.	EN. NO.	PART NO.	DESCRIPTION	REF. DEL.
QTY PER ASSY				
LIST OF MATERIALS				
REMOVE ALL BURRS AND SHARP EDGES				
DRAWN BY: CC				
CHK. BY:				
MFG. ENG.				
APPD.				
APPD.				
ECO NO.				

**NET** TIME & FREQUENCY TECHNOLOGY INC.  
 3000 Olcott St., Santa Clara, California 95050  
 (408) 248-8266

TITLE: FIGURE 6-9  
 PRESELECTOR COUNTER BOARD

SIZE: DRAWING NO. D  
 6601-1950

SCALE: NONE

If You Didn't Get This From My Site,  
 Then It Was Stolen From...  
[www.SteamPoweredRadio.Com](http://www.SteamPoweredRadio.Com)



Model 764

Display Board Assembly

Assembly # 6608-1330

Ckt. Ref.	Description	TFT Stock No.
CR1	LED HP 5082-4487 Clear	1285-4487
DS1	LED HP 5082-7732	1285-7732
DS2	LED HP 5082-7730 8	1285-4404
DS3	LED HP 5082-7730 8	1285-4404
DS4	LED HP 5082-7730 8	1285-4404
DS5	LED HP 5082-7730 8	1285-4404
DS6	LED HP 5082-7730 8	1285-4404
R1	Res Car Comp 1/8W 1% 390	1061-0390
R2	Res Car Comp 1/8W 1% 390	1061-0390
R3	Res Car Comp 1/8W 1% 390	1061-0390
R4	Res Car Comp 1/8W 1% 390	1061-0390
R5	Res Car Comp 1/8W 1% 390	1061-0390
R6	Res Car Comp 1/8W 1% 390	1061-0390
R7	Res Car Comp 1/8W 1% 390	1061-0390
R8	Res Car Comp 1/8W 1% 390	1061-0390
	PCB Display 764	1600-1330 REVA

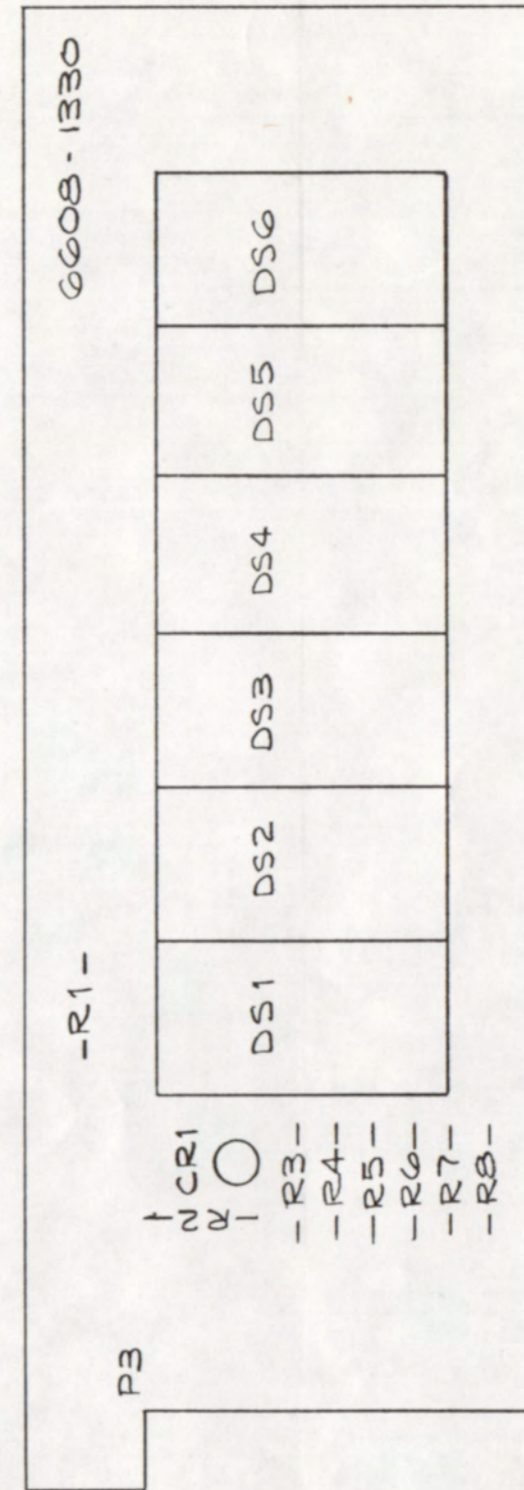

NEXT ASSY	USED ON	REVISIONS					
6608-1330	764	SYM	DESCRIPTION	DR	CHK	AUTH	DATE
		A	REL TO PRODUCTION	TD			1/8/76

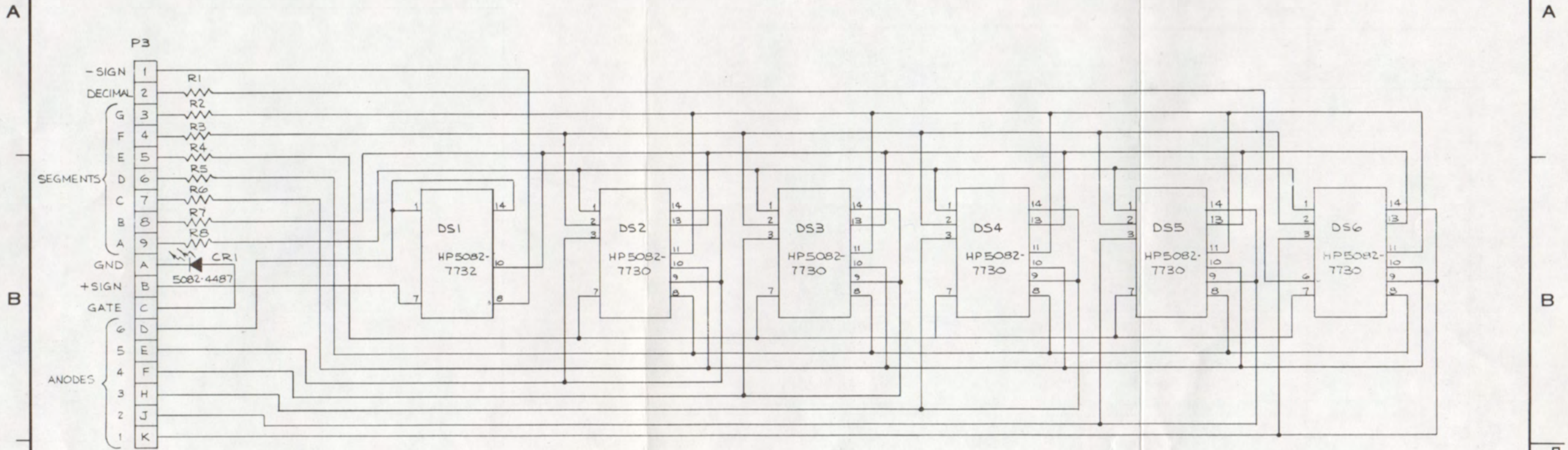

If You Didn't Get This From My Site,  
Then It Was Stolen From...  
[www.SteamPoweredRadio.Com](http://www.SteamPoweredRadio.Com)

1 RESISTORS ARE 390Ω, 1/8W, 1%  
NOTES, UNLESS OTHERWISE SPECIFIED:

QTY PER ASSY	ITEM NO.	EN NO.	PART NO.	DESCRIPTION	REF. DES.
LIST OF MATERIALS					
<b>REMOVE ALL BURRS AND SHARP EDGES</b>					
DRAWN BY		DATE		<b>TET</b> TIME & FREQUENCY TECHNOLOGY INC. 3000 Olcott St., Santa Clara, California 95050 (408) 246-6365	
CHK. BY		DATE			
PROJ. ENG.		DATE		TITLE	
MPG. ENG.		DATE		FIGURE 6-10 SCHEMATIC: DISPLAY BO.	
APPD.		DATE		SIZE	
APPD.		DATE		DRAWING NO.	
ECO NO.		DATE		SCALE	
				REV. A	
				SHEET 1 OF 1	

Model 764

PC Bd Carr Freq Alarm Opt

Assembly # 6608-1200

Ckt. Ref.	Description	TFT Stock No.
C1	Cap Mica 150 PF	1001-0151
C2	Cap Mica 150 PF	1001-0151
C3	Cap Mica 150 PF	1001-0151
C4	Cap Mica 150 PF	1001-0151
J1	Socket, I/C 16 Pin	2250-1016
J2	Socket, I/C 16 Pin	2250-1016
Q1	Xistor 2N4275	1271-4275
Q2	Xistor 2N4275	1271-4275
Q3	Xistor 2N3643	1271-3643
R1	Res Car Comp 1/4W 5% 10K	1065-1002
R2	Res Car Comp 1/4W 5% 4.7K	1065-4701
R3	Res Car Comp 1/4W 5% 2.2K	1065-2201
R4	Res Car Comp 1/4W 5% 1K	1065-1001
R5	Res Car Comp 1/4W 5% 2.2K	1065-2201
R6	Res Car Comp 1/4W 5% 4.7K	1065-4701
R7	Res Car Comp 1/4W 5% 4.7 K	1065-4701
R8	Res Car Comp 1/4W 5% 4.7 K	1065-4701
U1	I/C DM74LS76N	1101-7476
	Xistor Socket 3 Pin	1150-0001
	Xistor Pad 3 Pin	1150-0003
	Dio IN3064	1281-3064
	PC Board 764 Carrier Freq Opt	1600-1200 REVA

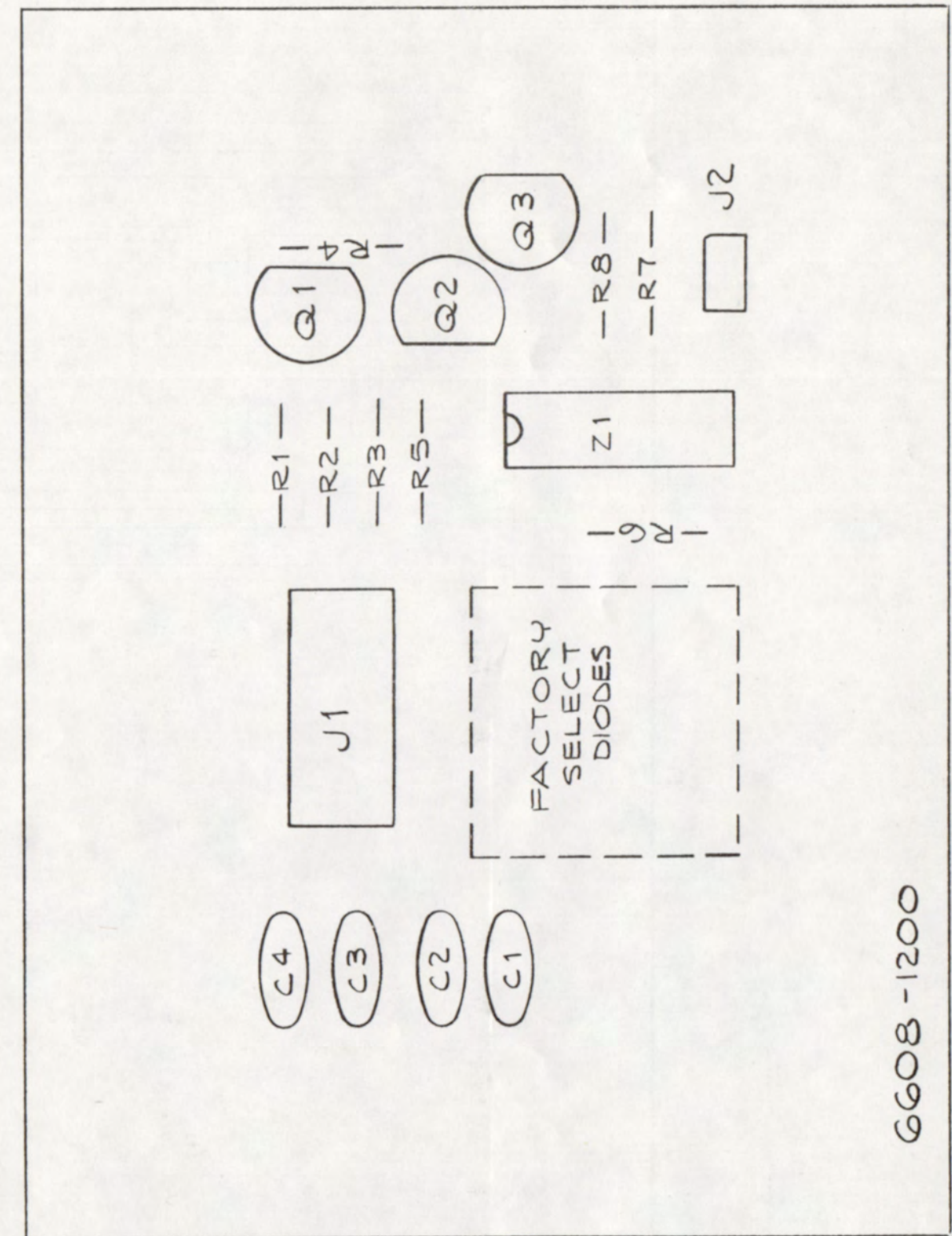

NEXT ASSY		USED ON		REVISIONS				
SYM	DESCRIPTION	DR	CHK	AUTH	DATE			
6608-1200	754/764	A				RS		4-1-76
		B				TD		6-17-76

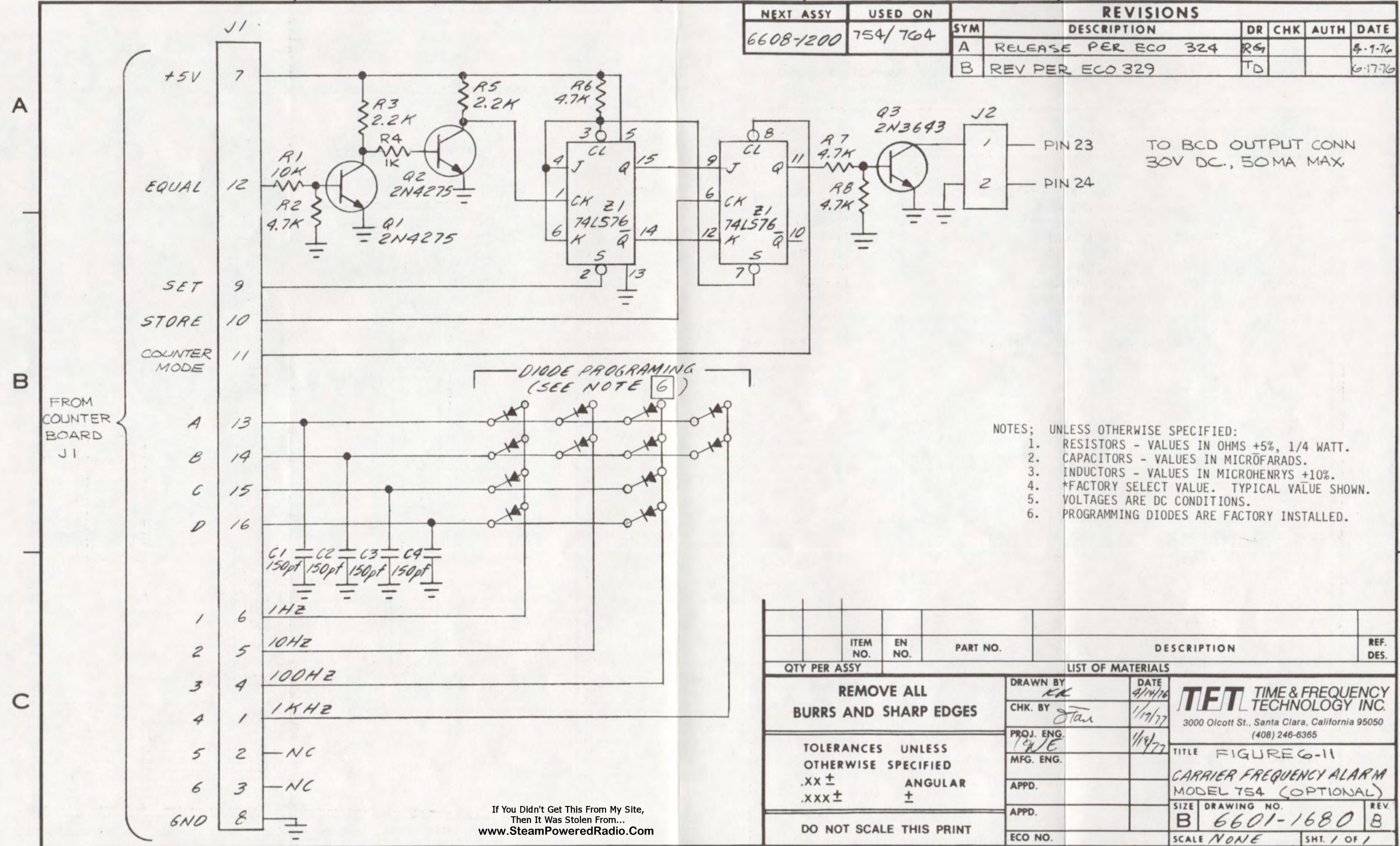

TO BCD OUTPUT CONN  
30V DC., 50MA MAX.

- NOTES; UNLESS OTHERWISE SPECIFIED:
1. RESISTORS - VALUES IN OHMS +5%, 1/4 WATT.
  2. CAPACITORS - VALUES IN MICROFARADS.
  3. INDUCTORS - VALUES IN MICROHENRYS +10%.
  4. \*FACTORY SELECT VALUE. TYPICAL VALUE SHOWN.
  5. VOLTAGES ARE DC CONDITIONS.
  6. PROGRAMMING DIODES ARE FACTORY INSTALLED.

ITEM NO.	EN NO.	PART NO.	DESCRIPTION	REF. DES.
QTY PER ASSY				
LIST OF MATERIALS				
REMOVE ALL BURRS AND SHARP EDGES			DRAWN BY <i>KK</i>	DATE 4/14/76
TOLERANCES UNLESS OTHERWISE SPECIFIED			CHK. BY <i>Star</i>	DATE 1/17/77
.XX ±			PROJ. ENG. <i>WJE</i>	DATE 1/18/77
.XXX ±			MFG. ENG.	
DO NOT SCALE THIS PRINT			APPD.	
			APPD.	
			ECO NO.	
			<b>TFT</b> TIME & FREQUENCY TECHNOLOGY INC. 3000 Olcott St., Santa Clara, California 95050 (408) 246-6365 TITLE FIGURE 6-11 CARRIER FREQUENCY ALARM MODEL 754 (OPTIONAL) SIZE B DRAWING NO. 6601-1680 REV. B SCALE NONE SHT. 1 OF 1	

Model 764/765

PC BD BCD OUTPUT

Assembly # 6608-1190

Ckt. Ref.	Description	TFT Stock No.
C1	Cap. Tan 10 mfd 20V	1008-0101
U1	I/C MM74C04	1102-7404
U2	I/C MM74C195	1102-4195
U3	I/C MM74C195	1102-4195
U4	I/C MM74C195	1102-4195
U5	I/C LM341-5	1100-4105
U6	I/C MM74C902	1102-4902
U7	I/C MM74C902	1102-4902
	I/C 14 Pin	2250-1014
	I/C 16 Pin	2250-1016
	PC Board BCD OUTPUT	1600-1190 REVA

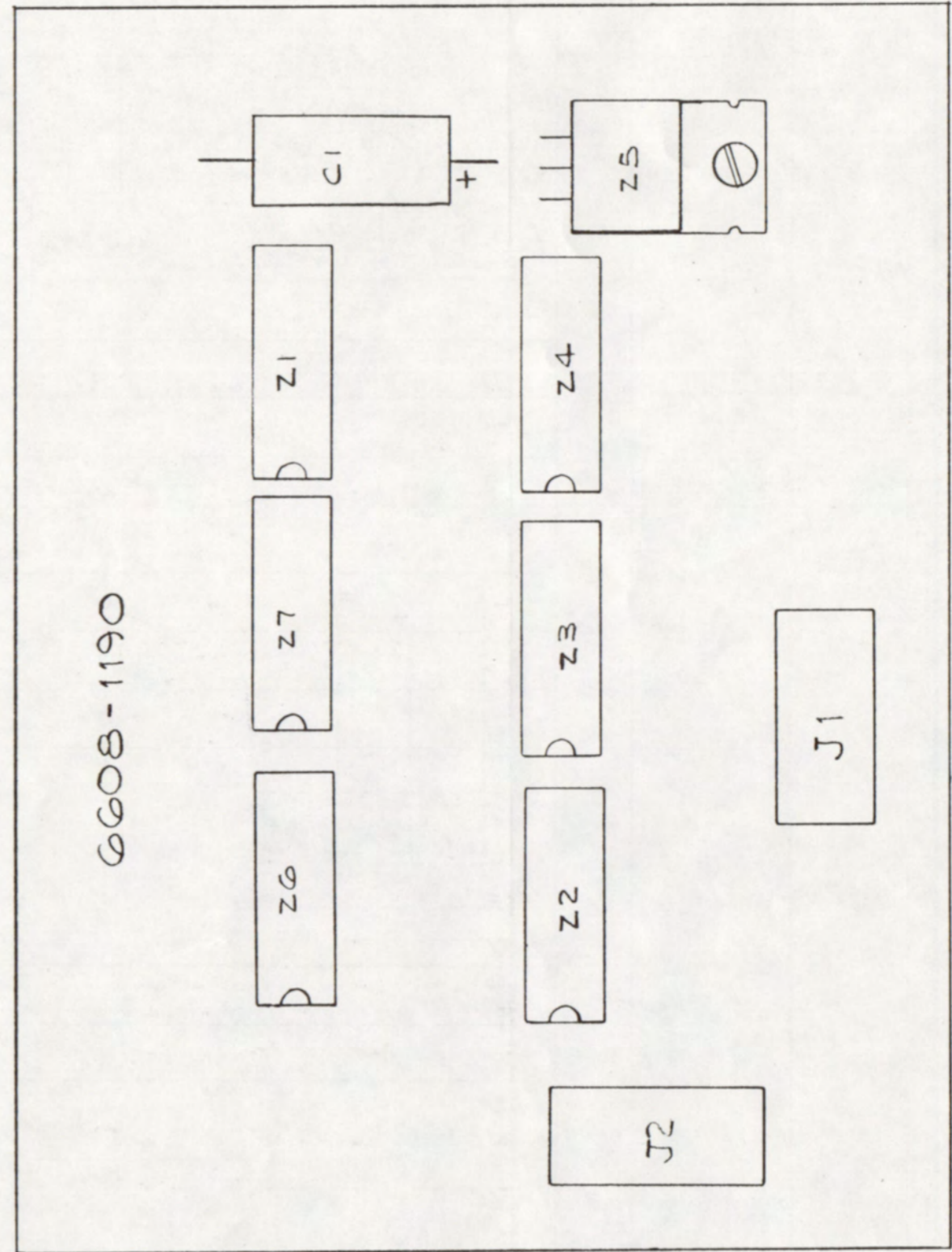

NEXT ASSY	USED ON	REVISIONS					
6608-1190	764	SYM	DESCRIPTION	DR	CHK	AUTH	DATE
		A	RELEASED PER ECO	RG			4-9-74

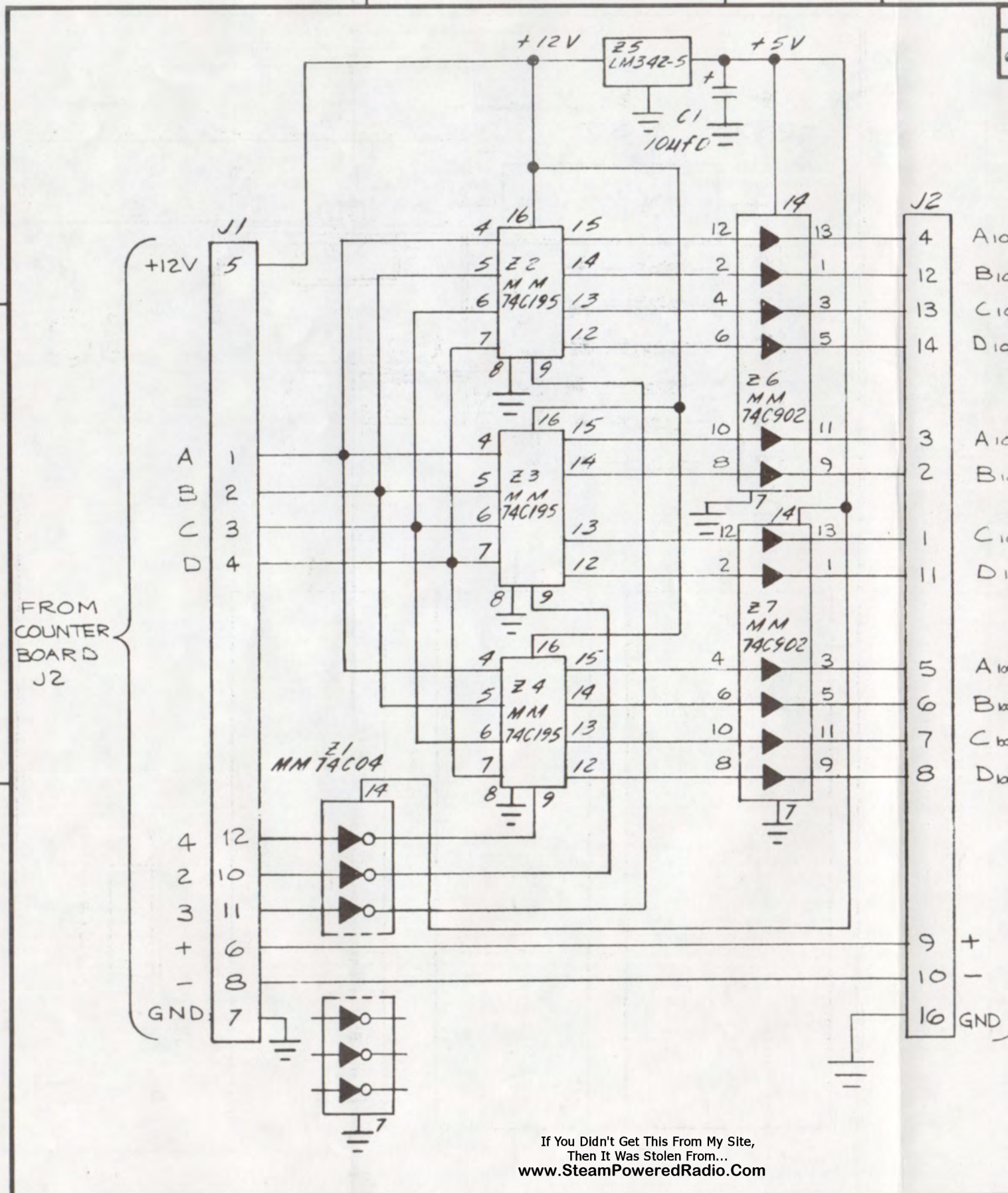

- 4 A100
- 12 B100
- 13 C100
- 14 D100
- 3 A10
- 2 B10
- 1 C10
- 11 D10
- 5 A1000
- 6 B1000
- 7 C1000
- 8 D1000
- 9 +
- 10 -
- 16 GND

TO BCD OUTPUT CONNECTOR

PIN#

1	A1000	13	+
2	B1000	14	-
3	C1000	15	
4	D1000	16	GND
5	A100	17	
6	B100	18	
7	C100	19	
8	D100	20	
9	A100	21	
10	B100	22	
11	C100	23	FREQ ALARM
12	D100	24	GND.

ITEM NO.	EN NO.	PART NO.	DESCRIPTION	REF. DES.
QTY PER ASSY				
LIST OF MATERIALS				
REMOVE ALL BURRS AND SHARP EDGES			DRAWN BY <i>DunBay</i>	DATE 4/15/76
TOLERANCES UNLESS OTHERWISE SPECIFIED .XX ± .XXX ±			CHK. BY	
ANGULAR ±			PROJ. ENG.	
DO NOT SCALE THIS PRINT			MFG. ENG.	
			APPD.	
			APPD.	
			ECO NO.	
TITLE FIGURE 6-12 BCD OUTPUT MODEL 764		SIZE B	DRAWING NO. 6601-1910	REV. B
SCALE NONE		SHT. 1 OF 1		

If You Didn't Get This From My Site,  
Then It Was Stolen From...  
www.SteamPoweredRadio.Com

Model 764 765

Power Supply

Assembly # 6608-1460

Ckt. Ref.	Description	TFT Stock No.
C1	Cap Elect 4000 Mfr 16V	1010-4001
C2	Cap Elect 1000 Mfd 25V	1010-1001
C3	Cap Elect 1000 Mfd 25V	1010-1001
C4	Cap Elect 50 UF 25V	1010-0051
C5	Cap Elect 100 UF 50V	1010-0105
C6	Cap Elect 100 UF 50V	1010-0105
CR1	Dio Rect IN4002	1284-4002
CR2	Dio Rect IN4002	1284-4002
CR3	Dio Rect IN4002	1284-4002
CR4	Dio Rect IN4002	1284-4002
CR5	Dio Rect IN4002	1284-4002
CR6	Dio Rect IN4002	1284-4002
CR7	Dio Rect IN4002	1284-4002
CR8	Dio Rect IN4002	1284-4002
J17	Plug 6 Pin	2250-6006
P14	Plug Molex 10 Pin	2250-6410
R1	Res Car Comp 1/4W 5% 100	1065-0100
U1	I/C Reg 1/2 Amp + 5V	1100-4105
U2	I/C Reg 1/2 Amp 12V	1100-2012
U3	I/C Reg 1/2 Amp +12V	1100-4212
U4	I/C LM78L24CZ	1100-7824
	PCB Power Supply 764	1600-1460 REVA

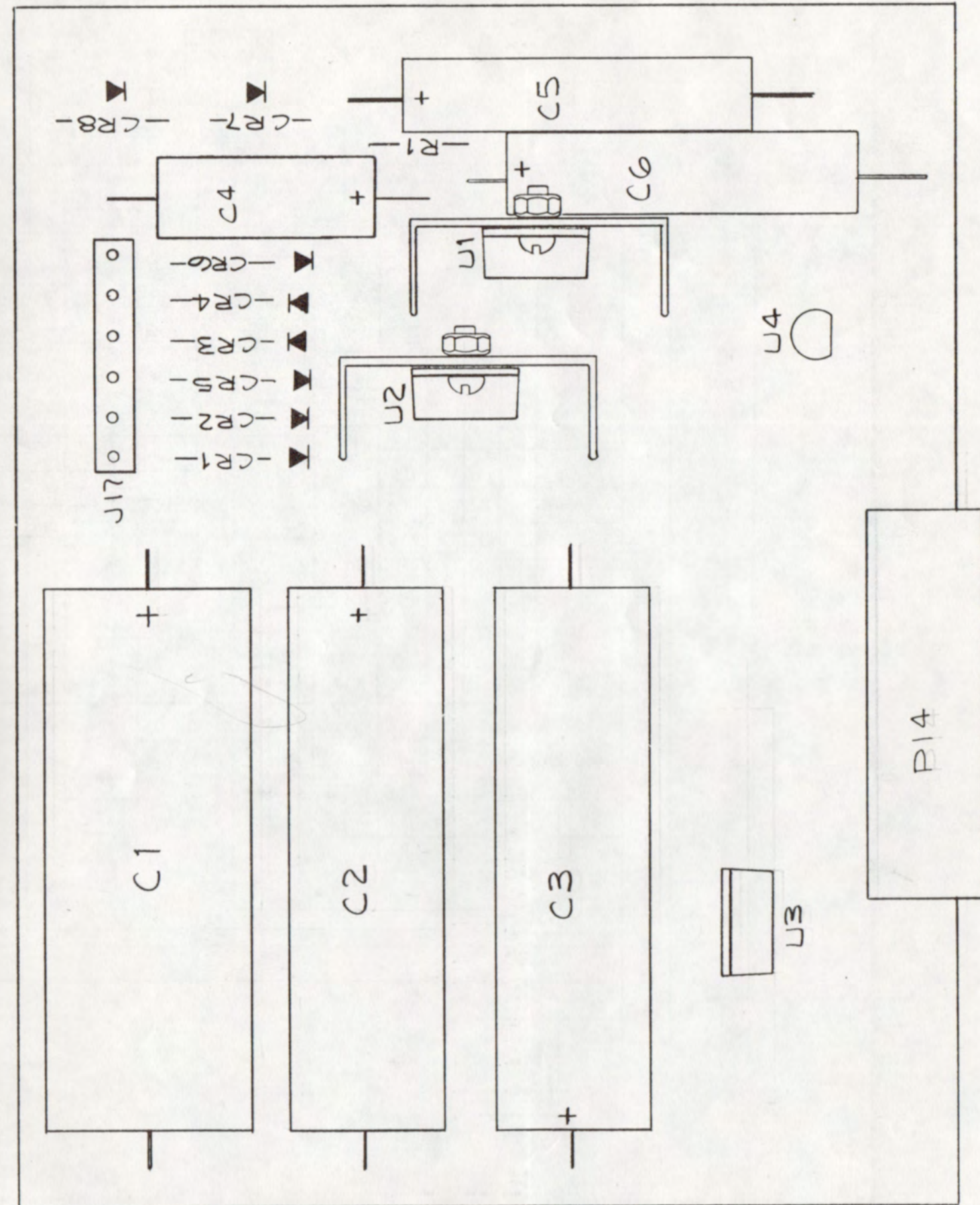

1

2

3

DWG. NO.

4

5

NEXT ASSY	USED ON	REVISIONS					
	764-765	SYM	DESCRIPTION	DR	CHK	AUTH	DATE
		A	REL TO PRODUCTION	T.D.			

A

B

C

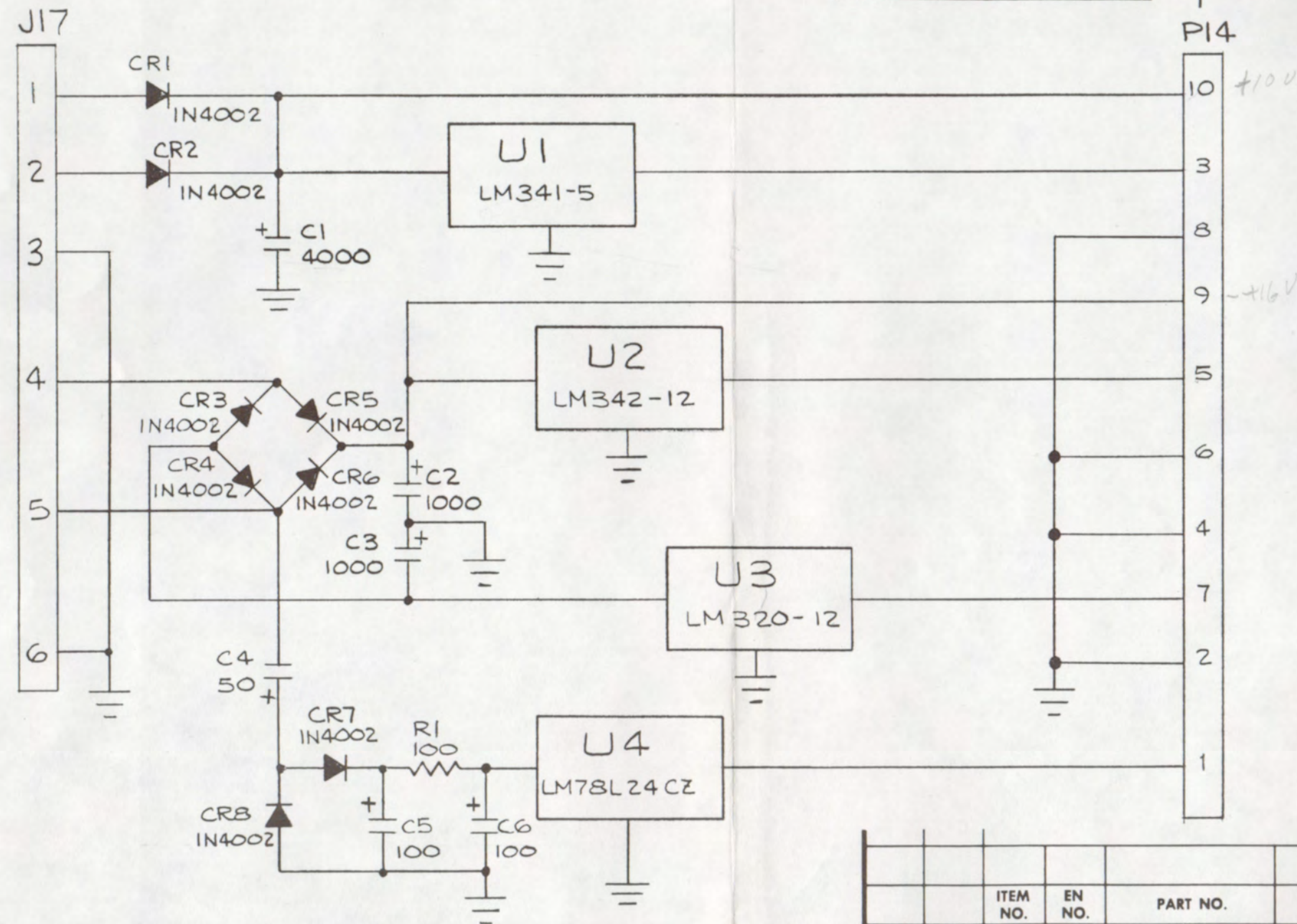

2. CAPACITOR VALUES ARE IN MICROFARADS  
 1. RESISTORS ARE 1/4W, 5%, COMP, OHMS  
 NOTES, UNLESS OTHERWISE SPECIFIED;

QTY PER ASSY	ITEM NO.	EN NO.	PART NO.	DESCRIPTION	REF. DES.
LIST OF MATERIALS					
REMOVE ALL BURRS AND SHARP EDGES				DRAWN BY	DATE
				CHK. BY	DATE
TOLERANCES UNLESS OTHERWISE SPECIFIED .XX ±      ANGULAR .XXX ±      ±				PROJ. ENG.	DATE
				MFG. ENG.	DATE
DO NOT SCALE THIS PRINT				APPD.	
				APPD.	
ECO NO.				SCALE	SHT. 1 OF 1

**TFT** TIME & FREQUENCY TECHNOLOGY INC.  
 3000 Olcott St., Santa Clara, California 95050  
 (408) 246-6365

TITLE FIG. 6-13  
 SCHEMATIC : POWER SUPPLY MODEL 764

SIZE B DRAWING NO. 6601-1800 REV. A

1

2

3

4

5



Model 764/765

Chassis Parts

Ckt. Ref.	Description	TFT Stock No.
	Switch Rotary Knob for 1825-0025 Transformer, Power Display Window LED, panel mount for 765 Manual 764/765	1825-0025 2370-1523 1500-0016 REVA 3000-0150 1285-4403 5004-0764