

HOW RADIO AND ELECTRONIC TUBES WORK

8FR-4



NATIONAL RADIO INSTITUTE

WASHINGTON, D. C.

ESTABLISHED 1914

STUDY SCHEDULE NO. 8

For each study step, read the assigned pages first at your usual speed. Reread slowly one or more times. Finish with one quick reading to fix the important facts firmly in your mind, then answer the Lesson Questions for that step. Study each other step in this same way.

- 1. **The Tube as an Electronic Switch**.....Pages 1-5
This section gives the ways in which electron emission can be produced, then describes thermionic emission in full. After learning this, you are shown how a diode tube can be used as a one-way device. This is the basic action of rectifiers and detectors—two important radio circuits. Answer Lesson Questions 1, 2, 3 and 4.
- 2. **Basic Tube Construction**.....Pages 6-10
Here are the important facts about the kinds of materials used in making tube filaments, cathodes and plates. This is important information, because the materials used determine the conditions of tube operation. Answer Lesson Questions 5 and 6.
- 3. **Basic Tube Characteristics**.....Pages 10-15
The voltages applied to a tube are limited to values within the operating range. Here you learn what limits there are.
- 4. **The Triode Tube**.....Pages 15-25
This section should be read and studied over and over. The triode is the basis for all multi-element tubes and is the basic amplifier tube. Be sure you understand exactly how the signal on the grid is used as the "pattern" for the tube to reproduce another and larger voltage within its plate circuit. Answer Lesson Questions 7 and 8.
- 5. **Multi-Element Tubes**.....Pages 25-28
A brief introduction to tubes having many elements. You will meet these tubes in later lessons. Answer Lesson Question 9.
- 6. **Special Purpose Tubes**.....Pages 29-30
Photoelectric cells, gas-filled tubes and cold-cathode types are explained.
- 7. **Tube Classification Systems**.....Pages 31-36
Practical information on the identification of tubes and their base pin connections. You will use this system constantly in your radio work. Answer Lesson Question 10.
- 8. **Start Studying the Next Lesson.**

HOW RADIO AND ELECTRONIC TUBES WORK

The Tube as an Electronic Switch

VACUUM TUBES are the heart of modern electronics. They are used not only in broadcasting and receiving radio entertainment, but also in commercial radio (aircraft, police, ship-board, and radio-telegraph systems), telephone repeater systems, diathermy equipment, and many other applications. In fact, tubes are used in devices which can see, hear, talk, feel, taste, smell, count, sort objects, keep time, control machinery, detect intruders, and cure diseases! And they range in size from tiny hearing-aid tubes scarcely larger than a thumbnail up to five-foot tall transmitter giants.

Let us now learn what kinds of tubes there are, how they operate, and what they can be made to do. These facts will apply to all tubes, whether they are used in broadcast, f.m., or television receivers or in transmitters. We must also learn something about tube weaknesses, since tubes are responsible for more radio breakdowns than any other part.

► When we have finished our study of tubes, we will be ready to put coils and condensers together in practical circuits, then to combine them with resistors and tubes to form actual radio circuits.

Electron Emission. In ordinary electrical circuits, electrons stay within the circuit wiring, and flow only over complete paths. However, in a tube, *electrons are forced out of the surface of a metal cathode, and are made to flow across a space.* Let's see how electrons are made to do these things.

► Electrons normally stay within a conductor, because an atomic force

prevents even free electrons from escaping through the conductor surface. An ordinary current flow through a conductor is a result of an *exchange* of electrons from atom to atom. There is no *loss* of electrons, because others replace those which pass on. However, if an electron can gain enough energy, it can separate itself from the atoms of the conductor and become a "free agent" in space.

► There are four ways in which electrons can gain enough energy to escape into space from a metal or metallic compound. These are: 1, they can be evaporated or driven out by applying heat; 2, they can be driven out by bombardment with very small high speed particles, such as other electrons; 3, they can be driven out of some materials by the energy in light rays (which are electromagnetic waves); and 4, they can be jerked out by a very high positive potential.

All four of these methods are used in various types of electronic tubes to provide the free electrons on which all tubes depend for their operation. However, the first method (applying heat) is by far the most common, so we shall first deal with the *thermionic* tube. (Thermionic is pronounced *THERM-I-ON-IK*: thermo means heat, ionic refers to electrons.)

THERMIONIC EMISSION

Suppose we start with a tube consisting of a filament, made of thin resistance wire, enclosed in a glass or metal bulb from which all the air has been pumped. If we connect a battery to this filament (Fig. 1), the current

flowing through the filament will heat it, and, when the filament has become hot enough, electrons will be emitted from it. (A vacuum is necessary in the bulb to prevent the filament from burning up at the temperature it will reach, and to remove the large air molecules which would interfere with electron emission.)

Electrons are emitted from the filament because the heat produced gives them enough energy to escape from the surface of the wire. The velocities with which they escape depend upon the amount of energy they get from the heat, and this starting speed determines how far they will go. Usually, they do not have velocities sufficient to take them very far from the filament, so a number of electrons soon are "hanging around" the filament. As this "cloud" of electrons be-

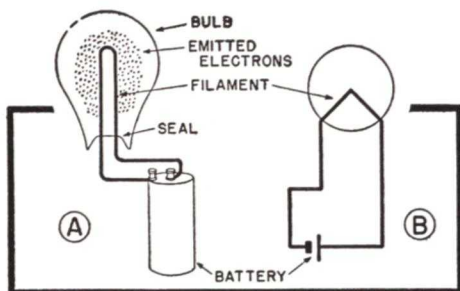

FIG. 1. When the filament is heated, electrons are emitted. Notice the symbols at B for the tube filament and for the battery.

comes thicker, they begin to repel each other, tending to force those closest to the filament back to the wire.

You learned in earlier lessons that removing electrons from an electrically neutral substance makes that substance positive. That is what happens to our wire filament—it becomes more and more positive as electrons are driven off from it by heat. This positive potential tends to attract electrons from the cloud back to the filament (unlike charges attract). Some of them do return, while others are

prevented from doing so by the repelling action of the electrons freshly emitted from the filament.

Eventually a state of equilibrium will be reached, with a practically constant number of electrons in the cloud about the filament, and with the number of electrons leaving the filament approximately the same as the number returning to it. The electron cloud in the space around the filament is called the *space charge*.

► It is important to realize that the current from the battery in Fig. 1 just heats the filament. The electrons emitted by the filament do not come from this battery current—they come from the atoms of the filament wire itself. We could heat the filament by a gas flame, or any other heating agent, and get the same electron emission for the same amount of heat. An electric current is generally used to heat the filament because this is the most convenient way to do it.

► Also—we show batteries only because they are a convenient way to indicate a d.c. voltage supply. This d.c. voltage might come from batteries, or from a power pack which converts a.c. to d.c., or from any other d.c. source. Don't think we are covering only battery type tubes—you are studying basic actions applying to all tubes.

THE PLATE

Now that we have a filament surrounded by a cloud of electrons, let us place a metal plate within the tube and bring a wire from this element to the outside of the tube. Further, let us connect a meter *M* to this wire, then connect another battery between the meter and the tube filament. This will give us the circuit shown pictorially in Fig. 2A, and schematically in Fig. 2B. For identification, we call the filament-heating battery an *A* battery, and the new battery the *B* battery, as marked in Fig. 2B.

Suppose we first connect the *negative* terminal of the *B* battery to the new element (which we shall call a plate), and the positive terminal of this battery to the filament, as shown in Fig. 2. (The circuit is completed from the negative *B* terminal to the plate through the meter.) We will

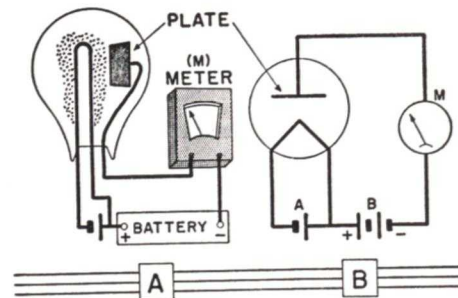

FIG. 2. Here the "plate" has been added. The meter indicates no current flow because the *B* battery has the wrong polarity.

find that the meter pointer remains at zero, showing that there is no electron flow in this "plate" circuit. There are two reasons for this. First, there is no electrical connection within the tube between the plate and the filament, so there is no metallic path for current (electrons) to follow. Second, the plate and the filament assume the potentials of the *B* battery terminals to which they are connected: the plate therefore becomes negative with respect to the filament. The *negative* plate will then *repel* the negative electrons emitted from the filament, so that they will not go to the plate and there will be no conduction through space in the tube.

► Now, let us turn the *B* battery around (Fig. 3) so that the plate becomes *positive* with respect to the filament. At once, the meter will indicate that a current is flowing—because now the negatively charged electrons are attracted by the *positive* plate (unlike charges attract) and are pumped through the circuit by the *B* battery so that they flow through the meter *M*,

through the *B* battery, and back to the filament.

In other words, free electrons in space obey the laws of charges—they are *repelled* by a negative plate, and are *attracted* by a positive plate. The number of electrons attracted depends on the *voltage* of battery *B* and on the *distance* between the plate and the filament. *Increasing the voltage of battery B* (thus making the plate more positive), or *decreasing the distance from the plate to the filament*, or both, *increases the ability of the plate to attract electrons*. Conversely, *decreasing the voltage or increasing the distance* decreases the attracting ability of the plate. (Of course, the distance between the plate and the filament is

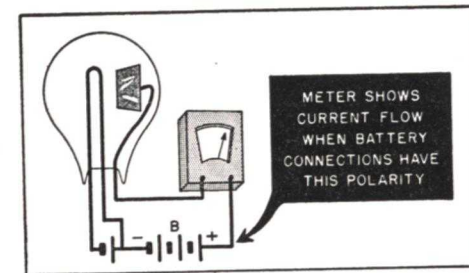

FIG. 3. The proper *B* supply polarity causes an electron movement from filament to plate, through the meter and the *B* battery back to the filament. (There must be a complete path back to the filament for there to be an electron flow. The *B* battery can "take in" at its positive terminal only the same number of electrons as it "lets out" of its negative terminal. Hence, free electrons are given back to the filament in exchange for those emitted.)

always fixed in any particular tube, so in a practical case, we generally consider that the voltage applied to the plate determines the ability of the plate to attract electrons.)

► What has happened to our space charge? Assuming average conditions, the electrons which go to the plate come from the space charge, and thus reduce the negative charge in the cloud around the filament. This, in turn,

allows an equal number of electrons to leave the filament to make up for this deficit in the space charge. Thus, there is a transfer action in which electrons leave the filament and go to the space charge, while other electrons leave the space charge and go to the plate. For most purposes, we can ignore this transfer and assume that electrons go directly from the filament to the plate, when the plate is made positive with respect to the filament by a B battery.

This electron movement continues through the meter and the battery so that an equal number of electrons are restored to the filament to make up for those emitted. Hence, there is a "complete circuit" effect when the plate is positive with respect to the filament.

► All vacuum tubes have at least two electrodes, a cathode and an anode. The cathode is the electron emitter and the anode (or plate) is the electron-attracting element. If these are the only electrodes in the tube, it is called a diode tube. "Diode" is pronounced *DI-OAD* (rhymes with "load"): "di" means two, and "ode" refers to electrodes or elements—hence a diode is a two-element tube.

RECTIFICATION

So far, we have described how it is possible for electrons to flow from the cathode to the plate in a tube when the plate has the proper polarity. Notice—the tube is obviously a "one-way" device, in that electrons can move *only* from the cathode to the plate, and then *only* when the plate is positive with respect to the cathode. Electrons do not normally move from the plate to the cathode.

► This one-way action makes a diode tube an important device in a.c. systems. Suppose we substitute an a.c. supply for the B battery, giving us the circuit shown in Fig. 4A. As you know,

an a.c. voltage reverses polarity periodically; so for one-half of the cycle, terminal 1 will be positive with respect to terminal 2, while for the other half-cycle, terminal 1 will be negative with respect to terminal 2. If our supply voltage is an a.c. sine wave, like that shown in Fig. 4B, we will find that plate current flows in pulses like those shown in Fig. 4C. In other words, plate current flows *only* for the portion of each voltage cycle when terminal 1 is positive with respect to terminal 2, and does not flow for the half of each voltage cycle when terminal 1 is nega-

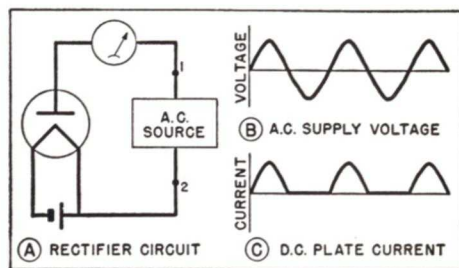

FIG. 4. A diode tube will permit current flow only when the a. c. voltage makes the plate positive with respect to the electron emitter.

tive with respect to terminal 2. In fact, we might consider the tube to be a kind of "electronic switch" that closes the tube circuit (and so permits current flow) only when the plate-to-cathode voltage has the proper polarity.

Thus, plate current flows in only one direction, and so is a *direct current*. The current is *pulsating*, varying from zero to some peak value which depends on the supply voltage, but it never reverses in direction.

► This is an extremely important characteristic of a tube. When we use an a.c. voltage supply in the plate circuit, the plate current will be a *pulsating d.c. current*. If this d.c. current is made to flow through a resistor, it must produce a *pulsating d.c. voltage drop* across the resistor. Thus, the

tube *rectifies* an a.c. voltage—that is, changes it to a d.c. voltage.

Fig. 5A shows the same circuit given in Fig. 4A, except that the meter in the latter has been replaced by a "load." This load might be a resistor, or a coil, or a complex electrical circuit. The tube in Fig. 5A acts, as you have just learned, as a one-way device and permits electron flow only in the direction indicated by the arrows, (and then only when the supply

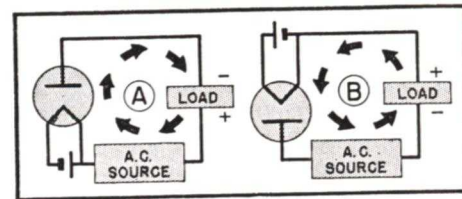

FIG. 5. The load voltage polarity is reversed by reversing the tube connections.

voltage polarity makes the plate positive). Hence, the voltage drop across the load will be a pulsating *d.c.* voltage which has the polarity shown. (By the use of filter circuits, which you will study later, it is possible to "smooth out" the variations in the current, so that the voltage across the load is practically a steady d.c. voltage like that delivered by a battery.)

► Should we want the load voltage polarity to be reversed from that in Fig. 5A, we need only reverse the plate and cathode connections as shown in Fig. 5B. Electrons still can go *only* from cathode to plate, so this reversal of the tube connections changes their direction through the circuit.

Practical Uses. Radio finds a number of important uses for the one-way action and for the basic circuits shown in Fig. 5. For instance, we can take power from an a.c. electric line and change it into a d.c. voltage which we can use to run a radio. This has made it possible to eliminate batteries when we wish to operate the radio from a power line. When a diode tube is used for this purpose, it is called a rectifier, and the circuit in which it is used is known as the "power pack" of the radio receiver.

Diode tubes have many other uses in radio which need not concern us at the moment. You will meet them all in later lessons.

► The one-way action of a tube is of great help to servicemen. It is frequently important to know the polarity of voltage drops in tube circuits. Now that you know electrons can pass through the tube only from the cathode to the plate, you can determine the direction of electron flow in any tube circuit just by looking at the tube. Then you can trace around the circuit and determine the polarity of the voltage drop in any device from the rule you learned earlier:

The end of any coil, condenser, or resistor which electrons enter is the negative end of that device.

For practice, use this method to find the polarity of the voltage drop across the load in Figs. 5A and 5B. You should arrive at the polarities indicated in these figures.

Basic Tube Construction

All tubes have a cathode and a plate, and all thermionic types have a filament. Since these elements are of such basic importance, let us take a few moments to learn just how they are made. This will teach you some important facts about the uses to which tubes can be put, and also the reasons for certain weaknesses which they have.

TUBE FILAMENTS AND CATHODES

The earliest tube filaments were made from pure metals. It was necessary to make these pure metals extremely hot before electrons could be forced out of the surface of the filament. Hence, it was necessary to find metals which would emit sufficient electrons for electronic tube purposes without being melted by the intense heat.

Pure Metals. The pure metal most commonly used for tube filaments is tungsten. This metal is capable of withstanding very high temperatures, but is a relatively inefficient electron emitter because a considerable amount of heat is necessary to get the desired degree of emission. This means the filament-heating supply must furnish a great deal of power.

Today, pure metal filaments (used as electron emitters) of this type are found only in high power transmitter tubes, where the ability to withstand high temperatures and the freedom from gas troubles (to be discussed later) make such filaments desirable.

Thoriated Filaments. After the development of the tungsten filament, it was discovered that certain impurities in the metal improved its electron emitting properties. Tungsten is a hard, brittle metal, and when pure is difficult to draw into the form of wire.

Engineers found that a little thorium mixed with the tungsten overcame the brittle properties, giving a more sturdy filament for light bulbs. Radio engineers tried these thoriated tungsten filaments and found them not only sturdier, but also much better as electron emitters than pure tungsten filaments.

The manufacturers subject a thoriated tungsten filament to a process called "activating" when the tube is constructed. In this process, the filament is first subjected momentarily to a high voltage overload, and then to a small voltage overload for a considerable period of time. The high flashing voltage at the beginning causes some of the thorium to flow from within the filament to the surface, and the baking process which follows causes this thorium to form a layer on the surface of the filament wire. This layer (which is about one molecule thick) has the property of increasing the electron emission tremendously. The temperature required to produce a desired number of electrons from a thoriated

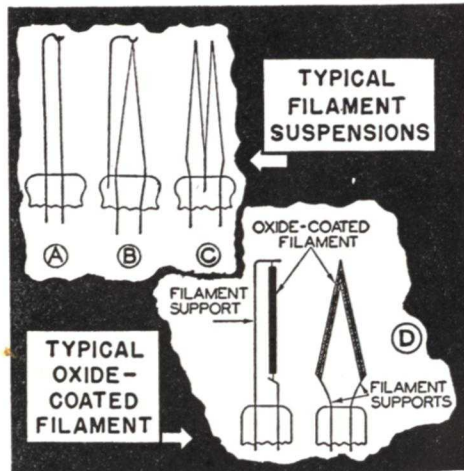

FIG. 6. Typical filaments.

tungsten filament is far lower than the temperature required to produce the same emission from a pure tungsten filament.

At one time thoriated filaments were used in practically all tubes. Today, they are found mostly in medium power transmitting tubes, having been replaced in the lower-power class and in receiving tubes by oxide-coated filaments.

Oxide-Coated Filaments. The oxide-coated filament is made by coating a filament wire of nickel or a platinum alloy with the oxides of certain metals. Oxides of barium, strontium, and calcium have been used.

Oxide coatings can be used only in tubes where the plate voltage is below 500 volts, for higher voltages jerk away the coating. Also, they can be used only in tubes where there is little chance of gas trouble. However, they are entirely satisfactory for receiving tubes and low-power transmitting tubes, where both these conditions are met.

► Oxide coatings are by far the most efficient electron emitters, requiring less heat than any other kind of surface for the desired degree of emission. This means that a low-power filament source can be used with an oxide-coated cathode. In fact, so little heat is needed that oxide-coated cathodes have been developed which are indirectly heated. These have proved very useful in reducing hum when tube filaments are operated from an a.c. source. (A.C. power will supply heat just as well as d.c. power, but hum is caused if the emission varies with the a.c. cycle changes. As you will learn later, a very heavy filament or an indirectly heated cathode is necessary to eliminate this hum voltage variation.)

► Now is a good time to clear up the meanings of the words "filament" and

"cathode." The *filament* is the proper name for the resistance wire supplying the heat. The *electron emitter* is called the cathode. When the filament does the emitting, it is also the cathode. Several different filaments, which are also cathodes, are shown in Fig. 6.

► In the indirectly heated cathode, the filament merely furnishes heat to the electron-emitting cathode, which is a separate element. The construction of several indirectly heated cathodes is shown in Fig. 7. The filament is threaded through holes in a ceramic insulator, which is placed inside a nickel-alloy sleeve or "thimble." This metal sleeve has the oxide coating

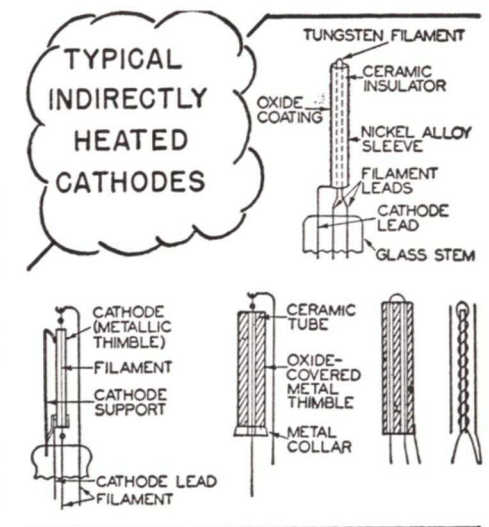

FIG. 7. A separately heated cathode emits electrons.

baked on it. (In some types, the filament wire is coated with the ceramic insulation and is then placed inside the sleeve.) The insulation prevents there being an electrical path between the cathode and the filament. Since the sole purpose of the filament in this construction is to supply heat, it is commonly called a heater. A tube using an indirectly heated cathode is frequently called a "heater type" tube, to distinguish it from the "filament

type" which uses the filament as the cathode.

► Metals stretch when heated, so the filaments in all tubes are mounted on spring supports which take up the "stretch" of the filament wire, thus preventing it from sagging and touching other elements; yet the springs allow it to shrink back to normal when the tube is not heated.

Tube filaments are delicate; a severe jar or excessive voltage will cause them to break or burn out. The proper

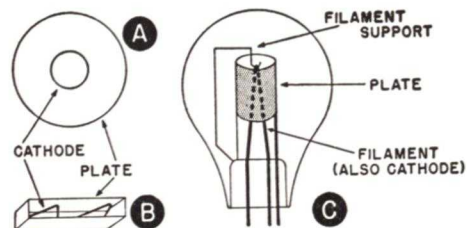

FIG. 8. Typical tube structures.

filament voltage is so important that the tube type numbers indicate the amount to be used, as we shall see later in this lesson.

VACUUM TUBE PLATES

The tube plate is subjected to considerable heat, some radiated from the filament and some produced by the electrons bombarding the plate itself. When electrons strike the plate, they give considerable energy to it. If the plate becomes hot enough, it too will begin to emit electrons. In fact, the one-way characteristic of the tube is dependent upon whether the plate remains relatively cool. Nickel, molybdenum, carbon, and pure iron are materials that have proved suitable for use in constructing plates or anodes. The plate is generally given a dull black surface, for black surfaces radiate heat readily and therefore keep cooler than polished surfaces.

The plates of medium power tubes are often fitted with fins to improve

their heat radiation. In high power tubes, water cooling or forced air draft is necessary to keep the plates at safe low temperatures.

► Even with the plate cool, the electrons striking it can knock other electrons loose from its surface. This effect, wherein speeding electrons knock loose other electrons from the surface of an element, is called *secondary emission*. If the plate or anode is the only positive element in the tube, this condition is not serious, as the secondary electrons will go back to the plate. In other tubes, special means are taken to eliminate the undesirable effects of this secondary emission. We shall learn what these are a little further on in this lesson.

► The plate shape depends somewhat on the shape of the cathode and on the structure of the other electrodes in the tube. In early tubes, it was just a flat plate off to one side. Now, it always completely surrounds the emitting sections of the cathode. If the cathode is a vertical wire or is indirectly heated, the plate will be a cylinder which surrounds the cathode, as shown in Figure 8A.

Where the filament is constructed like an inverted V or W (as it is in Fig. 6B or 6C), the plate will generally be an oblong or oval structure like that in Fig. 8B.

GAS EVACUATION

The normal tube has a very high degree of vacuum. If air is permitted in the tube, the filament will oxidize (burn up) when heated.

► An even more important effect of atmospheric gases within a tube is the fact that the speeding electrons will strike the gas molecules, knocking other electrons out of them. This changes the molecules into large, heavy, positive, gas ions. The cathode is negative, so the positive ions will travel to the cathode and bombard

it. Oxide-coated cathodes are easily ruined by such bombardment, for the oxide layer is knocked off completely. A thoriated filament is similarly destroyed, although not as easily. A pure tungsten filament is the only type capable of withstanding much gas ion bombardment.

► To eliminate the effects of gas as much as possible, vacuum pumps are used to draw out air and gases. During the evacuation process, the elements within the tube are heated by induction heating apparatus, which uses large coils to induce voltages in the elements. The resulting heat tends to drive out much of the gas. We ordinarily think of metals as being absolutely solid, but they have pores which will hold gas molecules until they are driven out by such heating.

In addition to the heating and evacuation, most tubes employ "getters." A getter is a small cup containing chemicals. During the induction heating process, these chemicals vaporize and combine readily with the gas molecules, forming metal compounds which then are deposited on the cool glass envelope of the tube. This is what gives the silvery appearance many tubes have near the base of the bulb. These compounds "hold on" to the gas molecules and do not readily release them in the tube space.

► Tubes having oxide-coated filaments cannot be heated to as high a temperature as can those having other filaments (the oxide coating will be boiled off if too much heat is applied), so the gas evacuation is not as good in these tubes. As a result, oxide-coated cathodes can be used only in tubes that are intended for relatively low power and low plate voltage. (As the plate voltage is increased, the electron velocity is speeded up and the heating effects are increased, so that there is more danger of electrons ionizing gas molecules present in the tube space and also of knocking out gas molecules from the metals.)

A tube with a pure tungsten filament, on the other hand, can be very highly evacuated, because tungsten is not affected by high temperatures. This is one reason why high power tubes, particularly transmitting tubes operating with plate voltages above 5000 volts, usually have pure tungsten filaments.

► While every effort is made to eliminate gases from within vacuum tubes, some special "gas-filled" tubes do have certain gases deliberately introduced in them. We will study these tubes, and the reason for putting gas in them, later in this lesson.

► Since the tube must be sealed completely, the wire leads going to the ele-

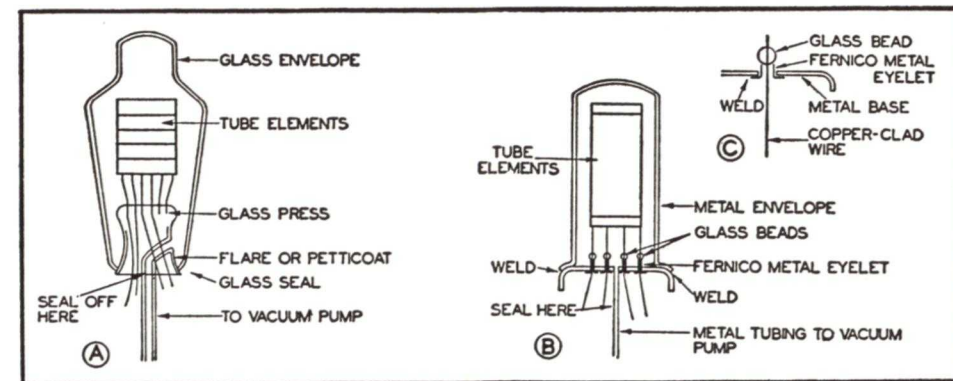

FIG. 9. A comparison of the construction of a glass envelope tube and a metal envelope tube.

ments must pass through a seal formed by a glass press or glass beads before emerging from the tube. Considerable research was necessary to find a metal to be used for these wire leads which had the same rate of expansion as the glass, so heating would not crack the seal. These wires are special alloys. The supports and connectors to the elements are welded to the wires within the tube.

► Fig. 9 shows the method of sealing both a glass-envelope tube and a metal-envelope tube. A metal tube differs from a glass tube in having

a metal envelope instead of a glass envelope, so a metal tube and a glass tube of the same type are electrically identical inside their envelopes.

After the gas is evacuated, the tubing which goes to the vacuum pump is sealed off and cut. The leads emerging from the tube are then fastened to prongs in a base, so that the tube can be plugged into a socket. Circuit connections are made to the socket, so the tube elements will be connected to the tube circuit when the tube is plugged into the socket.

Basic Tube Characteristics

So far, you have learned how the diode tube can be used as a rectifier. You have also learned some facts about the constructional features of these tubes, which also apply to all other types of tubes.

Now, let us learn more about how tubes operate. For simplicity, we shall use the diode as an example at first, then take up other tube types when you have mastered the important fundamental facts of tube operation.

FILAMENT VOLTAGE LIMITS

Suppose we set up the circuit shown in Fig. 10 to see just what happens as the filament and plate voltages are varied. (We have shown an indirectly-heated cathode type tube in this circuit, but might equally well have used a filament-cathode tube; the following explanations apply to either type.)

Let us start out with a relatively low plate-to-cathode voltage from battery *B*. (Radiomen shorten this, calling it just "plate voltage." You know voltage exists between two points, so the names "plate voltage" or "grid

voltage" refer to voltages between these points and some reference point, which is usually the cathode.)

Let us also set the variable resistor *R* in the filament circuit to a high value, so that very little current flows in the filament circuit. The tube filament and resistor *R* form a voltage divider. When the resistance of *R* is high, most of the voltage is across it and meter *V* shows very little voltage across the tube filament.

With very low filament voltage, the filament will not get hot enough to cause cathode emission, so the meter *I* will indicate zero plate current. Suppose we now reduce the resistance of rheostat *R* gradually. This lets more and more current flow through the filament circuit, and a greater proportion of the voltage appears across the tube filament. As a result, the filament becomes hotter, thus raising the temperature of the cathode. Soon meter *I* will indicate that a current is flowing in the plate circuit. This plate current means, of course, that electrons are being emitted by the cathode.

As we continue to decrease the value

of resistor *R*, the filament voltage continues to increase and, for a time, so does the plate current indicated by the meter *I*. However, we will eventually reach a point where the plate current no longer increases, even though the filament is made hotter.

Fig. 11 shows a graph of this action. As the filament voltage (E_f) is increased, the plate current (I_p) increases from *A* to *B* on the solid curve. At point *B*, the plate current ceases to increase much and the curve levels out toward *C*.

► Now suppose we start the experiment over, this time with a higher voltage from battery *B* in the plate circuit. We will again find that the plate current follows the curve from *A* to *B*, but now it goes on up along the dotted line to point *D*, where it levels out toward *E*. The higher plate voltage results in a higher plate current (the distance from *B* to *D*) before

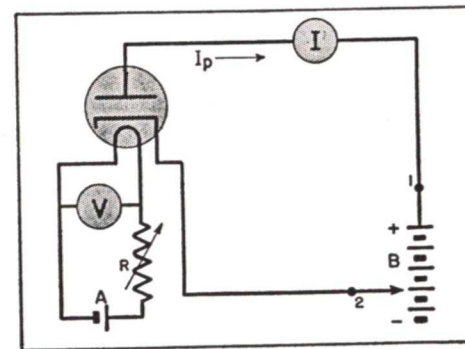

FIG. 10. A test circuit like this is used to determine the characteristics of diode tubes.

the curve levels off. Eventually, however, the leveling occurs.

Should we continue this experiment, increasing the value of the plate voltage each time, we would find that the events repeated themselves. Higher plate voltages would result in the curve rising higher before it leveled off. However, it would always level off at some point.

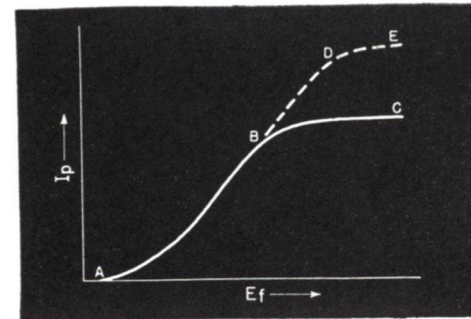

FIG. 11. How the plate current varies with different filament-heating potentials.

Temperature Saturation. We know that as the filament voltage is increased, the filament becomes hotter and hotter. This means more and more electrons are forced out of the cathode, so we might expect the plate current to continue to increase instead of leveling off. But, since the plate current finally becomes constant, evidently a point is reached at which only a constant number of the electrons forced out of the cathode go to the plate. Why don't all of them do so?

The answer lies in the space charge effect we have already studied. An electron newly emitted from the cathode is subjected to the attracting force of the plate (tending to pull it toward the plate) and also to the repelling effect of the electrons emitted just ahead of it (tending to push it back toward the cathode). When emission is low, all the emitted electrons are drawn to the plate. But as emission increases, the slower moving electrons begin to form the space charge. As the emission is further increased, electron repulsion by the space charge increases (because there are more electrons exerting a repelling force) while the attracting force of the plate remains constant. As a result, the net force pulling newly-emitted electrons to the plate decreases; this slows these electrons down, and they tend to bunch

up and join the electron cloud around the cathode.

Eventually, as emission increases, this electron cloud becomes so dense that we get the space charge transfer effect we described earlier. The plate pulls a constant number of electrons out of the space charge at any given instant; this same number of newly-emitted electrons can then enter the space charge, but any excess of newly-emitted electrons over this number is forced back to the cathode. The number of electrons the plate pulls out of the space charge depends upon the plate voltage and the distance from the plate to the space charge, but *not* on the emission.

Increasing the voltage on the plate will increase the current—because it will increase the number of electrons the plate can pull out of the space charge at any given instant. This merely results in a constant plate current of higher value, however, with the space charge still forcing excess electrons back to the cathode.

This means that for a particular plate voltage, there is a definite limit to the amount of current which will flow in the plate circuit of the tube. The only way you can get more current in a diode tube is to increase the plate voltage. Making the filament hotter will not increase the current greatly above the point where the curve begins to flatten out. The “bend” at point *B* on the solid curve (and at point *D* on the dotted curve) is known as the knee of the curve. The flat region of the curve beyond the knee is known as the saturation region. (A radio tube is saturated when the plate can attract no greater number of the emitted electrons.)

This condition, in which increasing the filament voltage will not cause a further plate current increase, is known as *filament saturation or temperature saturation*.

Filament Voltage Ratings. If a filament is heated too high it will, of course, melt. Hence, we cannot continue to increase the filament voltage indefinitely. In fact, the tube filament is designed to have a resistance such that it will reach a desired temperature when a particular rated voltage is applied to it. (As you will learn in a moment, the rated filament voltage is different for various tube types.)

The temperature the filament will reach is made high enough so that, for any normal plate voltage, there will always be more electrons emitted from the cathode than can be attracted to the plate. This makes the plate current depend only on the plate voltage, not on the emission. In other words, tubes are usually run well into the filament saturation region, so we'll be sure to have all the electrons we need.

What filament voltage values are used? The first tubes had to use battery power supplies, so filaments were designed to operate from 6-volt storage batteries or from groups of dry cells. The first storage battery types had 5-volt filaments, and a series resistor was used with them to drop the voltage from a 6-volt battery. The resistor value was reduced as the battery voltage decreased with age—a scheme which permitted longer operation before the battery had to be recharged.

The early tungsten filament tubes required a high filament current, because the filament had to be made quite hot before sufficient emission was obtained. However, when the more efficient thoriated tungsten and oxide-coated filaments were developed, lower temperatures could be used and less current was required for filament supply.

► The development of a.c. power supplies freed tube filaments from the necessity of operating from battery voltage values. Step-up or step-down

transformers readily deliver any desired voltage. Today, we have a.c. tubes with filaments rated at 2.5 volts, 6.3 volts, 12 volts, 25 volts, 35 volts, 50 volts, and even 117 volts. (The last named type can be connected directly across a 110-volt power line.)

You may wonder how a.c. can be used on the filament without causing plate current variations as the filament voltage varies. The answer is that filaments and cathodes are used which hold heat for an appreciable period of time. Battery tubes will warm up almost instantly, but it takes 30 to 90 seconds for a.c. tubes to “get going.” These tubes hold to a practically steady temperature during the small time space of an a.c. voltage variation, so there is practically no emission variation. We have to be careful with battery tubes, however, to see that a steady d.c. is applied to the filament.

► The numerous filament voltage values are the result of design requirements—some were developed for a.c.-d.c. receivers; some for auto sets; some for other purposes and reasons. Modern portable battery-operated receivers were made possible by the development of an entirely new line of 1.4- and 3-volt tubes, using far more efficient oxide-coated filaments than earlier types. These tubes have such low-current requirements that they can be run for a long time on small, lightweight batteries.

Transmitting tubes and other special purpose tubes have a similarly wide range of filament voltage ratings, so that a suitable tube can be found for each application.

Voltage Tolerances. Modern a. c. type tubes will operate over a fairly wide range about their rated filament voltages. For example, tubes with filaments rated at 6.3 volts will operate satisfactorily on voltages ranging from 5.8 volts to as high as 7 volts. **With filament voltages below this**

range, the emission may become too low for most uses, and with voltages above the range, the tube life may be shortened. (Practically all these tubes have oxide-coated cathodes from which the coating will boil off if the temperature gets too high. This will destroy a tube just as surely as a complete burn-out of the filament.) Naturally, if the voltage is too much higher than the rating, the filament will actually melt.

Modern 1.4-volt battery-type tube filaments are designed to operate from a single dry cell which has a rating of 1.5 volts, but which actually delivers 1.65 volts for a short time, then drops down to its 1.5-volt rating. The battery voltage gradually decreases to 1.2 volts, then the battery is supposed to be replaced. These tubes thus are intended to operate in the range from 1.2 to 1.65 volts. However, some circuits may cease functioning if the voltage drops below the 1.4-volt filament rating. A check of the filament voltage should be made in receivers using these tubes when they fail to work.

PLATE VOLTAGE LIMITS

Suppose we return to our circuit of Fig. 10 and this time apply the rated filament voltage so that the tube is operating in the temperature saturation region. Let us now start with zero plate voltage by moving tap 2 on plate battery *B* up to point 1. This means that none of the battery *B* will be in the circuit.

Under this condition, we will find that the meter *I* indicates zero plate current. Now, let us move the tap 2 down battery *B* a step at a time. As we gradually increase the voltage difference between the plate and cathode, we will find that the plate current increases slowly at first, then more rapidly and steadily as the plate voltage is increased. Finally, the plate

current increase begins to taper off. A plot of these results (Fig. 12) will give us a curve which is very similar to that shown in Fig. 11. This curve shows that for a fixed filament voltage, increasing the plate voltage above a certain value no longer gives proportional increases in plate current.

Voltage Saturation. As the plate voltage is increased, more and more

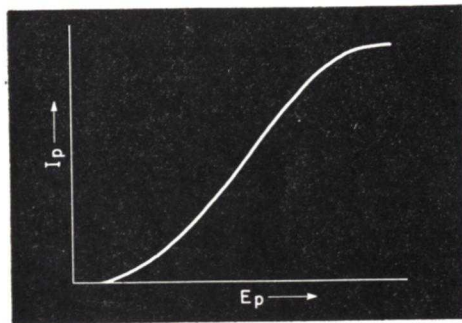

FIG. 12. How the plate current varies with the plate voltage.

electrons are drawn from the electron cloud. As we continue to increase the plate voltage, the space charge becomes less and less, thus losing its repelling effect on the electrons coming from the cathode. As a result, we will eventually reach the point where every electron the cathode can emit (at that temperature) is being drawn at once to the plate, and the space charge no longer exists. When this occurs, there is no way to increase the plate current further, except by making the filament hotter. We then have what is known as *voltage saturation* (increases in plate voltage do not produce proportional increases in plate current).

If we keep the filament temperature fixed, then voltage saturation places a limit on the plate current. However, with many tubes it is impossible to reach saturation without damage to the tube—because as the voltage is increased, the plate current becomes so

high that the electrons bombarding the plate can heat it to the melting point. ▶ Another factor which limits the allowable plate voltage is the spacing between the plate and other elements, and the spacing between the leads coming through the glass press or seal at the tube base. If the plate voltage becomes too high, it is possible for an arc (or electric spark) to jump between the elements. Should this arc jump between the leads in the seal, the tube will be destroyed.

The maximum plate-to-cathode voltage is always specified for each type of tube. Then, various sets of “operating voltage” values are given, which are equal to or lower than this maximum.

This rating limits the a.c. voltage we can apply in the circuit shown in Fig. 5. It also limits the d.c. voltage we can apply, as we shall learn when we take up tubes requiring d.c. plate voltages. Incidentally, since the early tubes were intended to operate from batteries, and the standard *B* battery is a 22½ or 45-volt battery, d.c. operating plate voltages were given in multiples of these values. Thus, 45, 67½, 90, 135, and 180 volts were common operating voltages for many tubes in the early days of radio. With the advent of a.c. power supplies, which can furnish any desired d.c. voltage, tubes were free of the necessity of operating from battery voltage values. Today, the most common receiving tube plate voltage rating is 250 volts, while transmitting tube ratings range up to 10,000 volts. Tubes intended for both battery and a.c. power pack operation are still rated at plate voltages easily obtainable from batteries.

PRACTICAL FACTS

From what you have learned, you can see that there are limits to the plate and filament voltages that can be used with any particular tube. Should

a tube be needed for a particular application, it is important to choose one having the proper ratings. This need for tubes designed for special purposes has led to the development of over 500 receiving type tubes alone.

▶ Fortunately it is not necessary to learn the values of the characteristics of all these tubes. You need to know

only what these characteristics *mean* and the limits they place on tube operation. Then, like all radiomen, you can refer to a tube characteristics chart and can look up the values for any tube in which you are interested. We will go into this more thoroughly later, after we have learned more about some of the other types of tubes.

The Triode Tube

The triode (*TRY-OAD*) or three-element tube is perhaps the most important development in radio's history. The additional element used in the triode makes amplification possible. Also, this tube started the development of other multi-element tubes which have made possible circuits undreamed of in the early days of radio.

You learned in earlier lessons that a radio wave, after it is picked up by an antenna, reaches the receiver in the form of an a.c. voltage. This voltage is called a “signal” voltage. It is usually very small, and must be amplified many times before it can be used to operate a loudspeaker and give us sound. In all radios except the very simplest crystal sets, this amplification of the signal voltage is furnished by tubes. The signal is fed into a tube, and an amplified signal is developed across a load in the tube plate circuit.

Can we use a diode to amplify an a.c. signal? Going back to the diode circuit shown in Fig. 5, you can see that the load voltage could never exceed the a.c. source value. (Kirchhoff's Voltage Law: *The voltage rises equal the voltage drops.*) In fact, since there is always some loss in the tube itself (it acts with the load as a voltage divider), you actually get less voltage across the load than is furnished by the source. Therefore a diode can-

not be used to amplify an a.c. signal, for the voltage developed across the load will always be smaller than the signal itself.

The triode, however, *can* be used to amplify a signal. With this tube, *the signal is used to CONTROL the voltage furnished to a load by a separate power source*, and even a very small signal can be made to control a considerable voltage. This action is obtained by applying the signal voltage between the cathode and an additional element within the tube.

HOW THE GRID WORKS

This new element is called a grid, and, as its name implies, is of open construction. This grid may be a spiral wire with large spaces between the turns, or it may be a wire mesh something like a window screen. Several typical grid constructions are shown in Fig. 13. Since the grid is an alternate “wire and space” affair, the grid symbol on a schematic diagram is usually like that shown in *13D*, although some engineers use the *13E* symbol.

The grid is positioned closer to the cathode than it is to the plate. (This spacing is not shown on schematic diagrams because the same symbol is used for all triodes, regardless of the actual spacing.) Before studying how

amplification is obtained, let us see how the grid can control the plate current. We will apply different voltages to this grid and see what happens.

Zero Grid Voltage. Suppose we first connect the grid to the cathode as shown in Fig. 14. Connected directly by a wire this way, these two elements have no voltage between them.

If we apply a normal plate voltage from battery *B* between the plate and cathode, we will get an electron flow, and this new element will have very little to do with it. The electrons are pulled along by the positive plate potential and only those moving di-

rectly toward a grid wire will strike it and either be deflected or captured. Those electrons traveling toward the spaces between the grid wires will go right through these spaces and on to the plate.

closer together the plate and electron are. Exactly the same thing is true of the grid; it, too, has a greater attracting power on an electron the closer it is to the electron. Since the grid is so much closer to the source of electrons (the cathode) than the plate is, naturally the grid has far more effect on electrons emitted from the cathode than the plate has if we apply equal voltages to both the grid and plate. As a matter of fact, the difference in effect is so great that we can apply a far larger voltage to the plate than to the grid, and still the grid will have more influence over the emitted electrons. Thus, the grid in Fig. 15 will attract a great many electrons from the cathode—many more than the plate does.

If the grid were a solid plate, it would capture all of the electrons it attracts toward itself and there would be a large current in the grid-cathode circuit. However, the open grid construction prevents this; again, only those electrons which happen to strike the grid wires are captured. The others tend to go in straight lines at high speed right through the spaces between the grid wires. Once well past the grid, they come under the influence of the plate, which then collects them.

This means that when the grid is made slightly positive, it increases the number of electrons which go to the plate.

As the grid is made more and more positive, the plate current increases further. However, as the grid becomes increasingly more positive, it attracts more and more electrons to itself. Eventually, it would begin to rob the plate of electrons, so there is a limit to the amount of increase in plate current which we can get by making the grid positive.

Negative Grid Voltage. Now suppose we reverse the potential on the grid, making it negative (see Fig. 16).

The grid will now repel electrons. If the negative voltage is high enough, all electron movement between the cathode and plate will be stopped; or, if the grid is made only slightly negative, the plate current will be decreased.

You can see, then, that a voltage applied to the grid element will control or vary the plate current. If the grid is made negative, the current decreases, while a positive grid causes a current increase. Should we apply an a.c. signal voltage between the grid and cathode, the alternate positive and negative half-cycles will produce up-and-down variations in the plate cur-

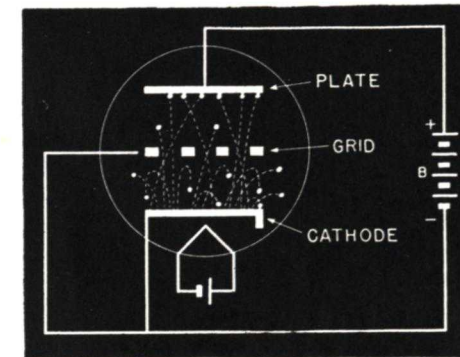

FIG. 14. With no grid bias, an average number of electrons flow to the plate, while the rest form the space charge between the cathode and the grid.

rent—up when the grid is positive, down when it is negative.

However, we're not looking for plate current variations: what we want is an amplified signal voltage. And we can get it very simply just by connecting a "load" R_L in the plate circuit, as shown in Fig. 17. The varying plate current then flows through resistor R_L , and the resulting voltage drop across R_L of course varies in exactly the same way as does current—which, in turn, varies in exactly the same way as does signal voltage on the grid. Thus, each variation in the grid signal voltage

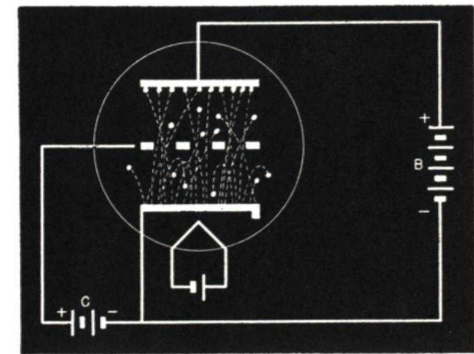

FIG. 15. Making the grid positive greatly increases the number of electrons moving to the plate.

causes a similar variation in the voltage drop across R_L . In other words, the signal voltage fed to the grid is reproduced as a similar signal voltage across R_L .

Notice—only a reproduction of the grid voltage, not the grid voltage itself, appears across R_L . Always keep this point firmly in mind. The grid voltage merely changes the plate current—it is the changing plate current which causes the signal voltage to be reproduced across plate load R_L .

The source of the plate current is, of course, the *B* supply—either a *B* battery or an a.c. operated power pack. None of the plate current comes from the signal source. All that the grid

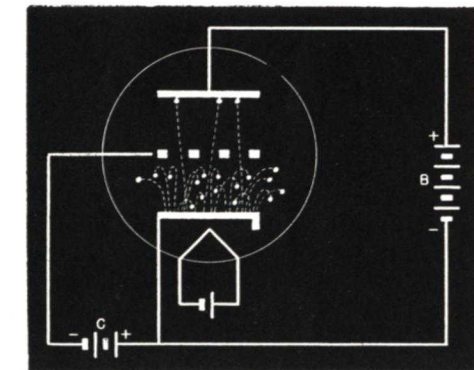

FIG. 16. A negative grid bias reduces the plate current.

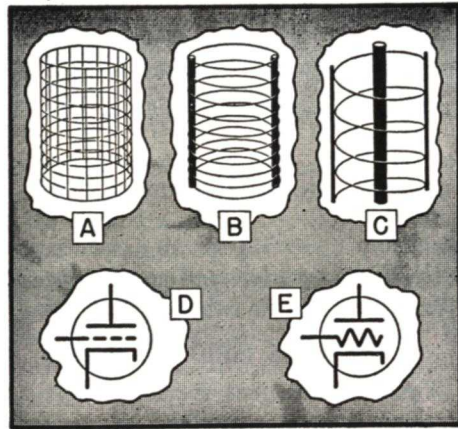

FIG. 13. Different grid structures and the symbols used to represent the grid element.

rectly toward a grid wire will strike it and either be deflected or captured. Those electrons traveling toward the spaces between the grid wires will go right through these spaces and on to the plate.

Positive Grid Voltage. Suppose we now put a small battery in the grid circuit, between the grid and cathode, as shown in Fig. 15. You will recall that the attracting power of the plate on an electron depends both on the plate voltage and on the distance between the plate and the electron, and this attracting power is greater the

signal does is *control* the flow of current from the *B* supply through the tube. You may find it easier to remember this action if you consider the grid to be a kind of "electrical valve" which controls the flow of plate current, but has nothing to do with supplying the plate current. (In fact, British technicians call tubes "valves" precisely because of this action.)

► Now, is this signal voltage developed across R_L the voltage we want? Remember, we started out with the idea of somehow using a tube to amplify a small signal voltage—that is, we wanted to produce a voltage which would have the same general form as our signal voltage, but would be considerably greater in size.

We know that the voltage across R_L has the same form as the signal voltage fed to the grid—it goes up when the grid voltage goes up, down when the grid voltage goes down. The only question is whether the voltage across R_L is bigger than the signal voltage. As you know from Ohm's Law, the voltage drop across R_L is equal to the current flowing through it (the plate current) times its resistance, or $E = I \times R_L$. This equation shows us that if R_L is large, even a fairly small plate current through it will produce a large voltage drop across it. And, by the same token, a fairly small change in plate current will produce a large change in the voltage drop across R_L .

Now, you learned a little earlier that the grid voltage is very effective in controlling the plate current: in other words, even a small change in grid voltage will produce a considerable change in plate current. And from what we said in the preceding paragraph, this change in plate current will produce a large voltage change across R_L (provided the resistance of R_L is large.) Thus, a small

signal voltage change fed to the grid will produce a large signal voltage change across R_L —so we have the *amplified signal voltage* we want.

► Where does this amplified signal voltage come from? Obviously, it is supplied by the only voltage source

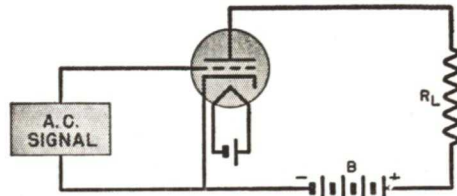

FIG. 17. The positive and negative alternations of the a. c. signal cause the plate current to vary up and down, producing a similar variation in the voltage across R_L .

in the plate circuit—the *B* supply voltage. The grid voltage therefore controls the amount of the *B* supply voltage which is developed across load resistor R_L . This means that the maximum signal voltage variation we can get across R_L is equal to the total voltage furnished by the *B* supply. (Actually, we can never get this much of a variation, since a considerable amount of the *B* supply voltage is dropped across the tube itself.)

THE E_g-I_p CURVE

There are limits which must be placed on the operation of triode tubes. For one thing, the amount of signal which can be applied to the grid is limited; if too much is applied, the resulting changes in the plate current will not be exact "carbon copies" of the applied signal. We then say that the tube is "distorting" the signal. Of course, we do not have to worry about this when handling small signals, but, after several stages of amplification, the signal is built up to such proportions that tubes capable of handling large grid voltage variations must be used.

To understand these limits better,

let us study a curve showing the relationships between the grid voltage and the plate current. This curve is called the grid voltage-plate current curve or the "grid-plate characteristic" curve. Radiomen generally abbreviate these terms to E_g-I_p curve or E_g-I_p characteristic.

The typical E_g-I_p curve shown in Fig. 18 has a shape similar to that of the other curves we have studied. However, we have both positive and negative values of grid voltage, so we must insert the vertical line $o-x$, representing zero grid voltage (the grid connected to the cathode with no voltage between these elements). Then, the distance along the horizontal line to the left of line $o-x$ represents increasingly negative grid voltage values, while the distance to the right represents positive values.

Let us start with a highly negative grid voltage, applied in the manner shown in Fig. 16. We represent this voltage by the distance from the $o-x$ line to point *A* in Fig. 18. With this grid voltage, there is no plate current flowing.

Now, suppose we gradually reduce this negative voltage. When we get to the value represented by point *B*, plate current will begin to flow (indicated by the fact that the curve begins here). Point *B* is known as the cut-off point, because it represents the negative grid voltage which cancels the effects of the plate voltage at the cathode. Any grid voltage more negative than this will cut off the plate current.

As we reduce the negative voltage further, the plate current increases. After getting past the bend or "knee" of the curve at point *C*, the plate current increases almost in step with the grid voltage change, causing the curve to be nearly a straight line between *C* and *D*. Then, when we pass the zero grid bias line $o-x$ and make

the grid increasingly more positive, we find the curve begins to flatten out toward *E*.

At the same time, as the grid is made increasingly more positive, grid current has begun to flow (shown by the dotted line). The positive grid is attracting electrons to itself. The grid current increases as the grid is made more positive; in effect, the grid robs the electron stream and thus reduces the number of electrons which we might expect to go to the plate.

Usually we do not desire grid current flow at all and do not desire to have the tube operate on any curved part of its characteristic when we are trying to amplify. (As we shall learn later, a curved tube characteristic will cause distortion.)

Grid Bias. To avoid grid current, the grid is kept negative at all times by a d.c. voltage connected between the grid and cathode in the manner

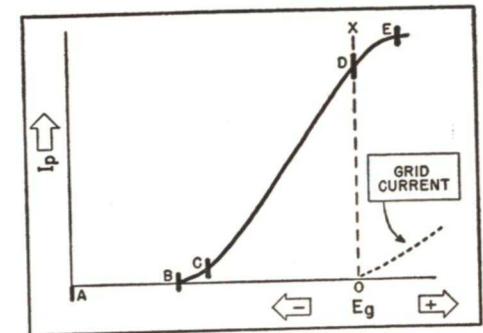

FIG. 18. This E_g-I_p curve is very important. It shows how the plate current varies with different grid voltage values.

shown in Fig. 19. (This voltage, commonly called a *C* voltage, is shown being furnished by a battery *C* in this figure, but other sources—which you will learn about later—are often used.) The value of this *C* voltage is chosen so that it causes the tube to operate somewhere near the middle of the straight portion of its E_g-I_p characteristic (point *F* in Fig. 20). This

fixed grid voltage is called a *bias voltage*, a name which comes from the fact that it *influences* or *controls* the initial operating plate current. For example, a bias voltage which makes the tube operate at point *F* on the characteristic in Fig. 20 sets the initial plate current at the value *M*.

After the point at which the tube operates on its characteristic has been set by applying a bias voltage, we can then apply an a.c. signal voltage to the grid. This a.c. signal voltage alternately adds to, and subtracts from, the grid bias voltage—that is, instead of the grid swinging negative and positive, it becomes alternately more negative and less negative.

► For example, if the bias voltage is -10 volts, and we apply an a.c. signal having a peak value of 5 volts, then the grid voltage will change alter-

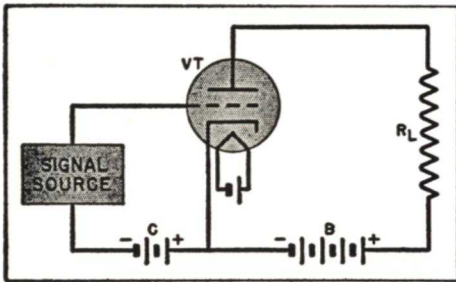

FIG. 19. Grid current flow is prevented by a negative bias.

nately from -5 to -15 volts. The grid voltage will be a pulsating d.c. voltage, since it will be a mixture of d.c. and a.c.

As Fig. 21 shows, these changes in grid voltage cause alternate increases and decreases in the plate current, just as any a.c. signal would. In this figure, point *F* represents the operating point of the tube as set by the bias voltage. When the grid voltage is varied by 1-2-3-4-5-6, the operating point must follow the instantaneous grid

voltage up and down the operating curve between points *F*, *C* and *D*. Thus, when the grid bias is reduced by the signal swing from 1 to 2, the grid is made less negative, so that the operating point moves *F* to *D*, permitting an increase in plate current from 7 to 8. Similarly, during the swing from 2 to 3, the grid is made

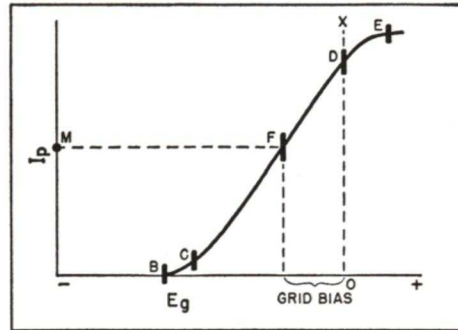

FIG. 20. Point *F* is the operating point, which is fixed by the bias voltage.

more negative, so that the operating point moves from *D* to *C*, resulting in the plate current falling from 8 to 9. Similarly, as the signal voltage moves from 3 to 4 to 5 to 6, the plate current varies from 9 to 10 to 11 to 12. Hence, the a.c. grid voltage 1-2-3-4-5-6 produces the plate current variation 7-8-9-10-11-12.*

► Should the bias voltage change during operation, then the plate current would be forced to follow this change, producing variations which are not caused by the original signal. The bias supply must therefore furnish a steady d.c. voltage so that variations in the plate current will be caused only by the signal voltage.

* A special data sheet on graphs will come to you with your graded answers for this lesson. This extra information was prepared as a part of the NRI Consultation Service, and there is no charge for it. This data sheet should be read carefully, as we feel its information will be particularly helpful with future lessons. However, remember that you don't have to draw graphs; you are expected only to be able to read them.

► Furthermore, the signal must not exceed the bias, because if it does, it can force the grid to become positive or can force the tube to operate over a curved section of its characteristic. Also, the bias must place the operating point properly on the straight portion of the characteristic curve.

As long as the tube operates along the straight-line portion of its characteristic curve, and as long as the a.c. voltage applied to the grid is not large enough to make the grid positive at any time, the plate current variation will be exactly like the grid voltage variation and will therefore produce voltage across the load resistor which is similar in form to the grid signal voltage. However, too high a signal voltage or operation over a curved portion of the characteristic will result in distortion. For example, in Fig. 22, the grid bias is too highly negative, so the operating point *M* is too near the lower bend of the curve. The curvature of the tube characteristic causes the bottoms of the plate current pulses to be chopped off, so the curve *A-B-C-D-E-F-G* is distorted (that is, it is not the same shape as the grid

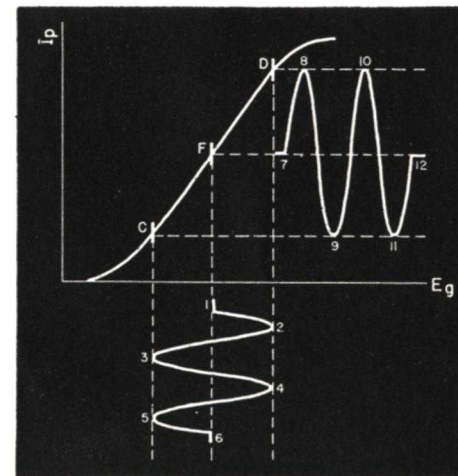

FIG. 21. The manner in which the grid signal variations increase and decrease the plate current is shown here.

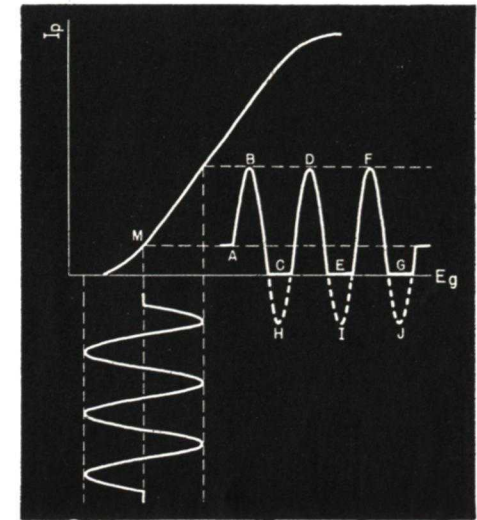

FIG. 22. If the operating point moves too far down on the curve, the plate current variations do not duplicate the entire signal.

signal). For perfect reproduction of the grid signal, the plate current pulses would have to follow the curve *A-B-H-D-I-F-J*.

THE TUBE AS A RESISTANCE

From what we've said about triodes, you can see that the *kind* of voltage we apply to a grid makes a vast difference in the performance and usefulness of a tube. If we apply only d.c. voltage (that is, bias voltage) to the grid, then the tube merely allows a d.c. plate current to pass through its plate circuit. A tube used under such conditions is nothing more than a resistor which limits the amount of d.c. flow from the *B* supply. When no a.c. signal is involved, we call the tube resistance its d.c. resistance. If we put a load resistor in the plate circuit, part of the voltage developed by the *B* supply will be dropped across the tube, the rest will be dropped across the load resistor. We can change the amount of current flow through the tube by changing the value of the bias voltage. The rela-

tive amounts of the battery voltage which are dropped across the tube and across the load resistor will change then.

If we increase the plate current, there will be a larger IR drop across the load resistor, and therefore a smaller drop across the tube. If we decrease the plate current, the IR drop

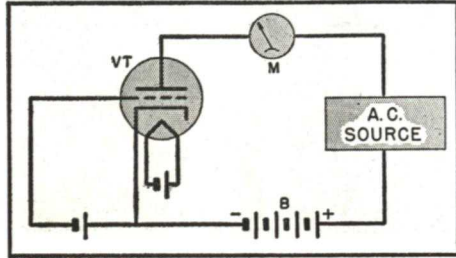

FIG. 23. Inserting an a. c. voltage in the plate circuit causes an a. c. variation in the plate current. The meter M measures only the a. c. portion of the current here.

across the load resistor will also decrease, and more of the B supply voltage will be dropped across the tube. In effect, a triode tube acts like a variable resistor, whose resistance we can change by changing the grid voltage. This is one way of looking at a tube—considering it as a variable resistor in series with a load resistor and a B supply. The resistance varies according to the signal variations, thus reproducing similar variations in the load voltage.

Unfortunately, such a picture of tube operation leads into difficulties when we try to calculate the amount of resistance variation, as this is a quite different value from the d.c. plate resistance. For this reason, we use another method of representing the a.c. operation of a tube, which can be used to compute the amount of a.c. voltage produced across a plate load resistor. This representation is called the "equivalent tube circuit." But before we go into it, we must learn the meaning of two useful new terms

—a.c. plate resistance and amplification factor—which are always part of any discussion of the a.c. operation of a tube.

A.C. Plate Resistance. The a.c. plate resistance is the opposition which a tube offers to the passage of a.c. through it. It can be measured with a circuit like that shown in Fig. 23. In this circuit, we first apply normal voltages to the filament, grid, and plate of the tube, then add a known a.c. voltage to the d.c. voltage which is already applied to the plate. The addition of the a.c. to the d.c. plate voltage makes the total voltage applied to the plate alternately larger and smaller, which in turn makes the plate current alternately larger and smaller. The plate current, in other words, becomes a pulsating direct current—which, as you know, is a steady direct current to which an alternating current has been added. We can measure the a.c. part of the plate current with the a.c. meter M.

Next, we divide the amount of a.c. voltage applied to the plate by the amount of a.c. plate current produced. This gives us the a.c. plate resistance of the tube—the opposition which the tube offers to the flow of a.c. through it. (This is NOT the same value as the d.c. plate resistance of a tube, which is what we would get if we divided the d.c. voltage applied to the plate by the d.c. plate current. D.C. plate resistance is very seldom mentioned in radio work.)

Whenever you see the term "plate resistance" or the symbol r_p (sometimes R_p) used—in a tube chart, for example—you can be sure that a.c. plate resistance is meant.

This a.c. resistance will change if the filament voltage, the d.c. grid voltage, or the d.c. plate voltage is varied, so each of these voltages must be specified when we state the a.c. plate resistance of a tube. This is done in

listings of tube characteristics in tube charts. The values of voltages given in these listings are generally those which would be used in some typical application of the tube concerned.

Amplification Factor. We have just seen that an a.c. voltage introduced in the plate circuit will cause an a.c. plate current, and we learned earlier in this lesson that an a.c. grid voltage will likewise cause an a.c. plate current. (In each case, of course, the a.c. plate current produced is mixed with the d.c. plate current which the B supply and the d.c. bias cause to flow, so the total plate current flow is a pulsating d.c.)

► One thing further we have learned: A grid voltage is more effective in controlling the flow of plate current than is an equal plate voltage. But—we still have not learned any way of telling how much more effective the grid voltage is. That is what the amplification factor of a tube tells us.

We could find the amplification factor of a tube with a circuit like that

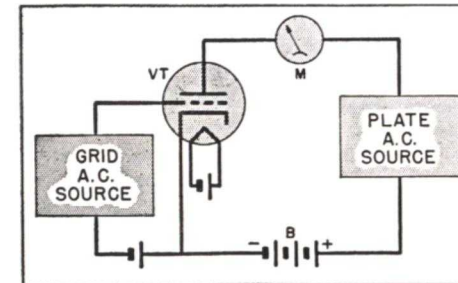

FIG. 24. The amplifying ability of the tube can be determined with this circuit.

in Fig. 24. First, we would turn off the a.c. source in the plate circuit, then apply a known a.c. voltage to the grid and measure (with a.c. meter M) the a.c. plate current produced. Next, we would turn off the a.c. source in the grid circuit, and would turn on the a.c. source in the plate circuit. We would adjust this a.c. plate voltage until we got the same a.c. plate

current as the grid produced. Finally, we would divide the value of this a.c. plate voltage by the value of the a.c. grid voltage we used. The answer would be the amplification factor of the tube.

Thus, we can define the amplification factor of a tube as the ratio of the a.c. plate voltage to the a.c. grid voltage necessary to produce the same a.c. plate current. This gives the relative effectiveness of the plate and grid voltages. For example, if we find that an a.c. voltage of 10 volts in the plate circuit is needed to produce as much a.c. plate current as an a.c. voltage of 1 volt in the grid circuit will produce, the amplification factor of the tube is $10 \left(\frac{10}{1} = 10 \right)$. In other words, the grid voltage is ten times as effective as the plate voltage in controlling the plate current. (The amplification factor is assigned the symbol "μ," the Greek letter "mu," pronounced "mew.")

The amplification factor of a tube depends upon the physical structure of the tube—the relative spacing of the grid to cathode, compared to the plate-to-cathode spacing, and the actual grid structure. It is therefore relatively constant as long as the tube is not damaged in any way that would jar the elements from their proper positions.

Equivalent Tube Circuit. Now that we know what a.c. plate resistance (R_p) and amplification factor (μ) mean, we are ready to take up the equivalent tube circuit which is so helpful when we want to learn what a.c. output to expect from a tube. This circuit is shown in Fig. 25. It is called an equivalent circuit because, as far as a.c. is concerned, it behaves just like a tube connected to a load. In other words, we transfer to the plate circuit an a.c. signal equivalent to an ampli-

fied grid voltage, then consider *only* the a.c. resistance of the tube.

Notice—in this circuit we replace the tube by an a.c. generator and a series resistor, and connect these two across the load R_L . The generator has a voltage output equal to μ times e_g (e_g is the a.c. grid signal voltage) and the series resistor has the value R_P . The fact that these two elements are the equivalent of a tube (as far as a.c. is concerned) illustrates two important things: 1, that the *total a.c. signal voltage* produced in the plate circuit is equal to the *grid signal voltage* multiplied by the *amplification factor* of the tube; and 2, that part of this plate circuit signal voltage is always dropped *within the tube* across the a.c. plate resistance of the tube.

You can see at once why it is important to know the μ and R_P of an amplifier tube. The amplification factor μ tells us immediately how much the tube amplifies the grid signal. If a tube has a μ of 10, then the total signal voltage produced in the plate circuit will be 10 times the signal voltage fed to the grid.

The a.c. plate resistance R_P lets us determine how much of this amplified signal we can actually use. As you see from Fig. 25, R_P and the load resistance R_L form a voltage divider. Part of the amplified signal voltage is dropped *within* the tube, across R_P ; the rest of it is dropped *outside* the tube, across R_L . Naturally, the only part of the signal voltage that is useful to us is the part dropped across R_L , because this is the only voltage we can feed into another circuit. The signal voltage dropped inside the tube (across R_P) is wasted; the power it develops is dissipated in heating the plate.

► Naturally, then, the value of load resistor R_L is very important in deciding how much *useful* amplification

of the signal voltage we will get. If R_L is zero, we will get no useful amplification at all; if it is very much larger than R_P , we will get a useful amplification almost as large as the μ of the tube. To distinguish between the *useful signal amplification we get out of a tube circuit* and the total signal amplification (μ), we call the former the *stage gain*. The stage gain

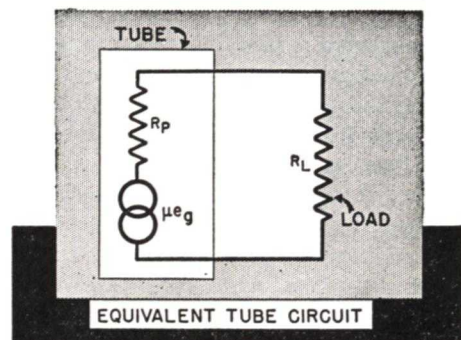

FIG. 25. The tube plate resistance and the load divide the a. c. voltage according to their values.

is always, of course, less than the μ of the tube: in fact, it is equal to μ times the ratio of the plate load to the sum of the plate load and the a.c. plate resistance. Or, in equation form,

$$\text{Stage gain} = \mu \times \frac{R_L}{R_L + R_P}$$

This equation again shows us that the larger R_L is with respect to R_P , the greater the useful signal voltage amplification we can get out of the tube circuit. However, there are practical limits to the value of R_L ; a value five to ten times the plate resistance gives about all the voltage gain possible under normal conditions. We will study this problem more when we take up amplifying stages.

► While on this subject, we might mention that sometimes *maximum voltage gain* may not be as desirable as *maximum power output*. For ex-

ample, it takes *power* to operate a loudspeaker; transmitters depend on power increases from stage to stage, etc. As we shall learn in a later lesson, power requirements affect the value of the load chosen and the tube design.

Remember—this *equivalent tube circuit* applies only to the *a.c. signal-amplifying operation of the tube*. It

has nothing to do with the d.c. voltages as applied to the tube (except that these voltages partially determine the R_P —and, in some special tubes, the μ —of the tube). You will meet the equivalent tube circuit many times more, both in your N.R.I. Course and in the literature of the Radio profession, because it is the most direct way to determine stage gain.

Multi-Element Tubes

We could make up any radio circuit with only the diode and triode tubes we have so far discussed. It would be impractical to do so, however, because many other types of tubes have been developed which are far more efficient for some radio uses than are diodes and triodes. We'll describe these other types briefly now, to give you an idea of their operations and uses; you'll learn all about them in later lessons of your Course.

SCREEN GRID TUBES

One important drawback of a triode, when used for radio frequency amplification, is the capacity between the grid and plate elements of the tube. These elements are conductors, separated by a dielectric (the vacuum), so that they make up a capacity (see Fig. 26). As you will learn in a later lesson, an undesirable feedback of energy occurs through this capacitive path, which causes r.f. amplifiers to become useless unless special circuits are used to cancel the effects of the feedback.

Tube manufacturers decided to improve the tube itself to eliminate this effect as much as possible. They brought out the screen grid or tetrode (four-element) tube, which has another grid located between the origi-

nal grid and the plate, as shown in Fig. 27. To distinguish between these grids, the original triode grid is now called the control grid, while the second is called the screen grid. In structure, the two grids are somewhat similar.

The addition of the screen grid causes an enormous decrease in the capacity between the control grid and the plate, and so almost eliminates the undesirable feedback. (Later lessons will explain how this is accomplished.)

A positive voltage (with respect to the cathode) is always placed on the screen grid; this voltage is usually somewhere between half and full plate voltage. Since the screen is considerably closer to the cathode than the plate is, its voltage has far more effect on the electron stream than the plate voltage has. In other words, *the screen grid voltage and the control grid voltage are the important factors which determine how many electrons pass through the tube*. The plate voltage acts principally to collect the electrons pulled through the tube by the screen grid voltage, and does not have a great deal of effect on the number of electrons pulled through. In fact, if we keep the control grid and screen grid voltages steady, we can

vary the plate voltage considerably without changing the plate current much.

Amplification. You will recall that the amplification factor of a tube is the ratio of the effectiveness of the grid voltage to the effectiveness of the plate voltage in controlling the plate current. In a screen grid tube, the control grid voltage is just about as effective in controlling the plate current as it is in a triode, but, as we have just seen, the effectiveness of the plate voltage is considerably reduced. This means, therefore, that the amplification factor of a screen grid tube is much larger than the amplification factor of a triode. Actually, the screen grid tube may have a μ between 100 and 600—while most triodes have a μ of 10 or less.

► However, as you learned in your study of the equivalent tube circuit, the amplified signal (μe_g) is divided between the tube a.c. plate resistance and the load resistance. The screen grid tube, unfortunately, has an ex-

PENTODE TUBES

The screen grid tube has the important advantages over a triode of having negligible grid-to-plate capacity and far higher gain. However, it has disadvantages when handling large signals.

Because the screen grid (which accelerates or speeds up the electrons

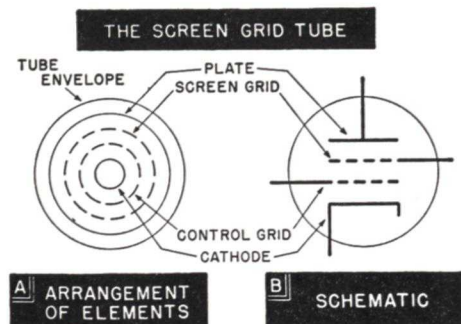

FIG. 27. The screen grid reduces the grid-to-plate capacity.

in their journey toward the plate) is fairly close to the cathode and has a high voltage, electrons travel much faster in a tetrode than they do in a triode. As a result, when they strike the plate, there is a much greater tendency for these speeding electrons to knock other electrons loose from the plate. This effect is known as *secondary emission*.

These secondary emission electrons fly off the plate. Many are attracted right back to the plate by its highly positive potential, but some go from the plate to the screen grid, which is also positive. This produces an undesirable current flow within the tube, and produces serious distortion if left unchecked. The effect is particularly noticeable as larger signals are being handled.

The *pentode* (five-element) tube shown in Fig. 28 solves this problem neatly. This tube has a third grid (a relatively coarse one, with only a

few turns of wire) inserted between the screen grid and the plate. This new grid is usually connected directly to the cathode, and is at the cathode potential—that is, it is *negative* with respect to the screen grid and the plate. This new grid is called a *suppressor grid* (or sometimes a *cathode grid*, because it is connected to the cathode).

The operation of the tube is somewhat similar to that of the screen grid tube, in that the screen grid speeds up the electrons toward the plate. However, the suppressor grid, which is at cathode potential, slows down the electrons somewhat when they have passed the screen grid; it also reduces the velocity with which they hit the plate. (Because the suppressor is so coarse in structure, it does not interfere with the number of electrons passing through the screen to the plate.) Even so, some electrons strike the plate with sufficient velocity to knock

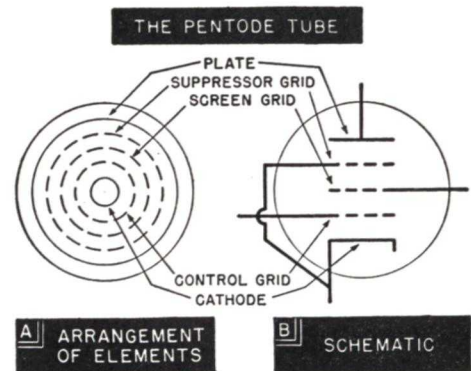
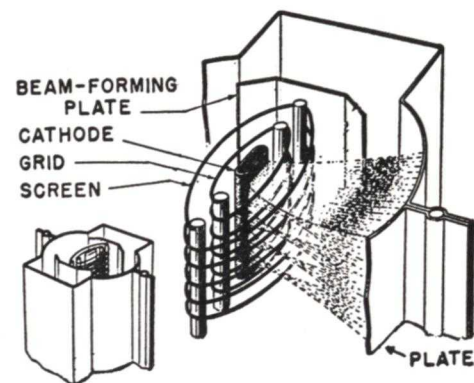

FIG. 28. The extra grid in the pentode tube reduces the effects of secondary emission.

out others, which then move into the space between the suppressor grid and plate. There they are subjected to two forces—the repelling force of the negative (cathode potential) suppressor grid and the attracting force of the positive plate. This double force makes practically all of them return at once to the plate.

BEAM TUBES

The *beam power tube* is another ingenious solution to this problem of secondary emission electrons. In effect, the electrons are made to act as their own suppressor grid. As Fig. 29 shows, a beam power tube has two small additional plates between the screen grid and plate. These small plates are connected to the cathode



Courtesy R.C.A. Mfg. Co., Inc.

FIG. 29. The electron "beam" provides its own suppression, forcing secondary emission electrons back to the plate.

just like a suppressor grid, and so repel electrons. This forces the electrons to "bunch up" in the space between these plates and flow in two concentrated streams or "beams" between the cathode and the true plate.

This concentrated electron flow prevents secondary emission electrons from reaching the screen grid, because any secondary electrons emitted from the plate immediately encounter the electron beams and are repelled back to the plate.

SPECIAL TUBES

The *pentagrid converter* (shown schematically in Fig. 30) is an example of a tube designed for a special purpose. The tube gets its name from the fact that it has five grids (*penta* means five), and is used as a fre-

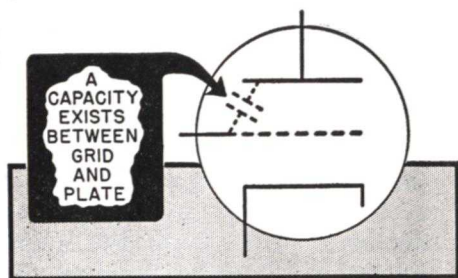

FIG. 26. The grid-to-plate capacity is troublesome in many applications.

tremely high plate resistance. In fact, it is not usually possible to bring the load resistance anywhere near the plate resistance value, so the useful amplification (stage gain) of a tetrode is considerably less than its amplification factor. Even so, a stage gain of 100 is not impossible, which is certainly a much higher stage gain than any triode can give.

quency converter tube. We'll go into details of its use in later lessons. Obviously, however, with all these grids we can get many different controlling actions on the plate current.

► In the early days of radio, the amplification of a single tube was quite limited, so the only way of get-

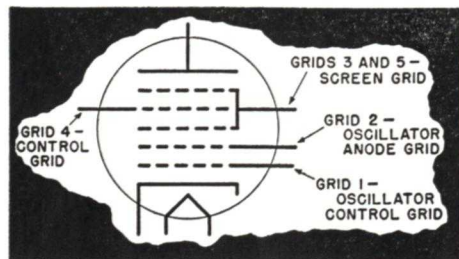

FIG. 30. A pentagrid converter tube.

ting more amplification was to have more tubes. As a hang-over from those early days, many people still believe that the more tubes, the better the radio. This has resulted in radio manufacturers at times using separate tubes, when they could have lowered costs somewhat by using one or more of the dual tubes available.

► For example, there are many applications which require the use of two diode tubes in the same circuit.

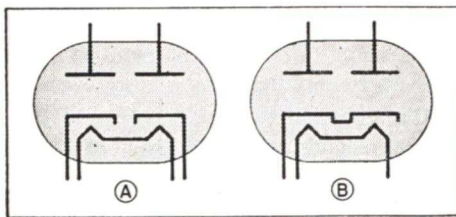

FIG. 31. Dual diodes.

It is logical to place both these diodes in a single bulb. Naturally, since a dual tube of this kind needs only a single bulb and a single base, it is somewhat cheaper than two single tubes and permits the use of a smaller chassis.

The schematic symbols for typical dual diodes (double diodes) are shown in Fig. 31. Some applications require separate cathodes as shown in Fig. 31A, while others permit combining the cathodes as shown in Fig. 31B.

► Another popular combination is that of the diode and triode tubes. The detector in most modern radios is a diode tube. Its output feeds into an audio tube, which is usually a triode. Another diode is desirable at the same point in the circuit for control purposes, so very often all three are combined in modern radios into one dual diode-triode tube. Fig. 32

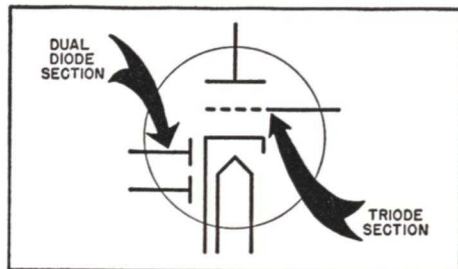

FIG. 32. Two diodes and a triode in a single envelope.

shows the schematic symbol for this tube. The same cathode is used for the triode and for the two diodes.

► Other similar combinations have been made. You will sometimes find together two triodes, a triode and pentode, two diodes and a pentode, and other similar combinations. Although these combination tubes are mounted in the same envelope, each section is generally independent of the others (except that they sometimes use the same cathode). You can always consider them to be separate tubes as far as circuit operation is concerned. We'll take up all these special tube types as we come to their uses in later lessons.

Special Purpose Tubes

There are other tubes designed for special purposes. Let's treat them briefly here, so you'll be familiar with their construction.

GAS FILLED TUBES

So far, we have been speaking entirely of vacuum tubes, which have as much air and gases removed as is economically possible or desirable. In a vacuum type tube, we do not want any gas ions to interfere with the electron movement. However, there is a special class of tubes, particularly diodes and triodes, in which a certain amount of gas is deliberately introduced.

These tubes are manufactured and the gases are evacuated in the same way as the ordinary vacuum tubes. Then, a definite, controlled amount of some particular gas is introduced in the tube to get some special action.

One result of this introduction of gas is a remarkable reduction in the plate resistance of the tube. When electrons move from the cathode to plate, they strike many of the relatively large gas molecules which are between the cathode and plate. The speed of the electrons is sufficient to knock other electrons out of these molecules. These extra electrons travel onward to the plate, along with the original electrons.

The heavy gas ions that remain are now positively charged (they have lost electrons). As a result, they move toward the cathode. When these positive ions get near the cathode, they combine with an equal number of the electrons in the electron cloud. If just the right amount of gas is used, practically all the electrons in the electron cloud will thus be removed from the cloud. In fact, the cloud will no longer exist, so all of the electrons leaving the

cathode will go directly to the plate. This means a high plate current will be developed for a relatively low plate voltage.

Gas type diodes are found mostly in power supply systems, where their low plate resistance results in a smaller loss of power within the tube. The supply must be carefully designed to prevent the plate current from rising above a certain critical value, however, or too many heavy ions will be formed, with the result that the cathode surface will be bombarded by the heavy particles and the oxide coating knocked off.

► Gas type triodes find special uses in industrial control equipment. These tubes are designed so that the grid merely acts as a trigger, starting the plate current flow at a certain predetermined value of grid voltage and then losing all control of it. This particular action is very desirable for certain control purposes, making it possible for a low-power circuit to turn on a high-power circuit.

PHOTO-ELECTRIC CELLS

In the beginning of this lesson, we mentioned that the thermionic (heating) method was only one of the ways in which electrons could be released from a cathode. Another method is used in one type of photo-electric cell.

Certain rare earth metals have the property of releasing electrons from their surface when light falls on the surface. (This is called the "photo-electric effect.") If we use one of these metals as a tube cathode and expose it to light, electrons will escape from it. Then, if a positive element is nearby, we will get an electron flow from this photo-electric cathode to the positive element, just as in our thermionic diode tube. The amount of current

depends on the number of electrons released, which in turn depends on the amount of light.

A typical photo-cell is shown in Fig. 33. The large "plate" is actually the cathode, as it is the surface on which light falls. As electrons are emitted from this surface, they travel to the thin wire, which is positively charged with respect to the cathode.

The photo-electric principle finds many uses in industrial control equip-

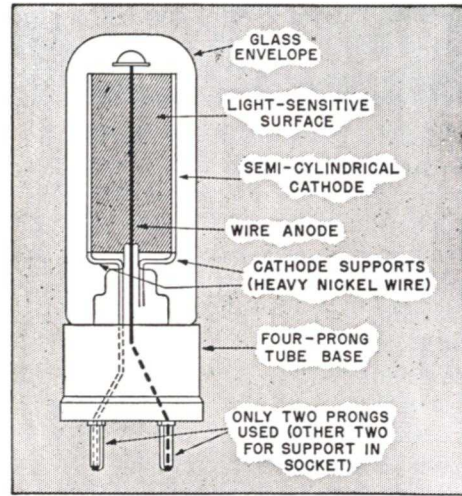

FIG. 33. A typical photoelectric cell.

ment. For example: Moving objects can interrupt a light beam shining on a photo-electric cell, thus momentarily cutting off the current through the cell and causing counting devices to operate.

► The television camera tube, used to pick up the image at the transmitter, is also a photo-electric device. There are many types of these tubes. One type is really a combination of thousands of miniature photo-electric cells

mounted together on a plate. When exposed to a scene, the various photo-electric cells emit electrons according to the light values of the tiny segment of the scene to which each is exposed. It is possible to pick up these small charges with a scanning device and transmit them as elements of a television scene.

COLD-CATHODE TUBES

There have been several types of dual diodes (known as "cold-cathode" tubes because their cathodes are not heated) developed for power packs.

These tubes are gas-filled. When the plate element is sufficiently positive with respect to the cathode, the gas will ionize, as electrons will be pulled out of the gas molecules toward the plate. Then, the heavy positive ions will bombard the cathode surface and knock electrons loose to replace those taken from the gas by the plate. The gas molecules thus re-form (become un-ionized) and the action repeats itself continuously as long as the proper potentials are maintained between the plate and cathode.

This action is reversible, since reversing the applied voltage would cause the plate and cathode to be interchanged. If it is desired to use such a tube as a rectifier (in which current flows only one way), one surface can be treated to release electrons more readily than the other, or the element intended to be the cathode can have a far larger surface area than the plate. This makes the tube conduct better one way than the other. Rectification is not perfect, as some current can still flow in the reverse direction, but it is satisfactory for some applications.

Tube Classification Systems

There are hundreds of different vacuum tubes, so it is absolutely necessary to have some means of telling them apart. Of course, one obvious difference between tubes is the number of elements in the tube. Hence, we have diodes, triodes, tetrodes, pentodes, and others. However, these classifications are too broad to be very useful in telling tubes apart, for there are many tubes of each of these types which differ in voltage requirements and other characteristics.

Thus, we have triode tubes with low amplification factors and triode tubes with high amplification factors. There are kinds of low-amplification tubes which differ greatly in plate resistance and in the voltages required on the filaments and other elements. Similarly, high amplification triodes are made in models requiring many different filament, grid, and plate voltages. Some of these tubes are intended to operate only from battery supplies, while others will operate with a.c. on the filament.

Furthermore, tubes vary greatly in size. There are tiny tubes for hearing aids and super-portable receivers, medium size tubes for ordinary small receivers, and full size tubes for standard radio receivers. Naturally, the basic operation of the tube is not affected by its size. However, it frequently happens that a regular size tube will not fit into a radio designed to use small tubes.

Filament Voltages. Thermionic tubes may be classified according to the filament voltage which they are designed to use. Plate or grid voltages may be abnormal for a particular tube without immediate or great damage, but if the filament voltage is too high, the filament will burn out. It is im-

portant that the filament voltage requirements be met. However, many tubes use the same filament voltages, so classification by filament voltage is (like classification by number of elements) too broad to be very useful.

Use Classification. Tubes may be classified according to their use, or rather, according to the use for which they were originally designed. Thus we have rectifiers, detectors, mixers, oscillators, r.f. and a.f. amplifiers, and power amplifiers. Often, however, it is possible to use one tube for several different purposes, so a given tube may have two or more usage classifications. ► Some time ago it was decided that the simplest identification system was to assign each tube type a number and to list tubes by their numbers in charts or tables of tube characteristics. We shall go into this system shortly—but first, let's learn something about how tubes differ in outside appearance.

TUBE BASES AND SOCKETS

Unlike other devices used in radio and electronic apparatus, the radio tube is a delicate part giving limited hours of service. Most manufacturers of radio tubes guarantee their products for one thousand hours. While tubes in general give much longer service than this, it is not impossible for a tube filament to burn out during the first few hours of its use. For this very practical reason, tubes must be built in such a way that they can easily be removed for testing and replacing. Hence, radio receiving tubes have bases with prongs or pins which serve as the terminals of the tube elements. These bases plug into sockets having spring contacts which bear against the prongs when the tube is in the socket. The circuit wiring is connected to the socket contacts, and thus to the tube

elements when a tube is plugged in.

It is, of course, necessary to make sure that a tube will fit into its socket in only one way, so that the socket contacts will always bear against the proper prongs. In older tubes, prongs of different sizes or different prong spacing arrangements were used to make the tubes fit just one way in sockets. Of course, this system means

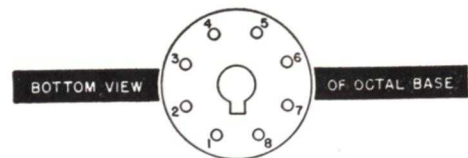

FIG. 34. The pin arrangement of an octal-based tube, which also corresponds to the bottom socket connections.

a different socket is necessary for each tube base type.

► Most modern tubes have "octal" bases which will fit a universal octal socket. All prongs on this base are the same size and are equally spaced. An aligning key in the center of the tube base fits a slot in the socket in only one way, thus assuring insertion of the tube in only one way.

Fig. 34 shows the prong arrangement of an octal base. This same base is used on diodes, triodes, pentodes, etc.; if any prong is unnecessary for a particular tube, it is simply left off. This does not affect the positions of the other prongs; if prong 6 in Fig. 34 is omitted, all other prongs will still remain in the same positions and will still be designated by the same numbers.

Fig. 35 shows typical tube bases of both the old and the octal types.

► Certain sets need tubes which will not easily loosen in their sockets. (Auto sets and portables are examples.) The "loctal" base is the answer to this. It is similar to the octal base except that the centering key has a ridge, shown in Fig. 36, which snaps

into a ring in the socket made of spring material and locks the tube in the socket. It is necessary to push a loctal-based tube sideways to release the key from the spring before it can be pulled out of the socket.

The prongs are exceptionally small on these tubes—really just projections of the connecting wires which come through the glass seal at the bottom of the tube. This eliminates the necessity for a tube base, as the glass seal positions the pins and the centering key is molded into the seal. These tubes offer advantages at ultra-high frequencies in that the elimination of the base reduces the amount of leakage at these frequencies.

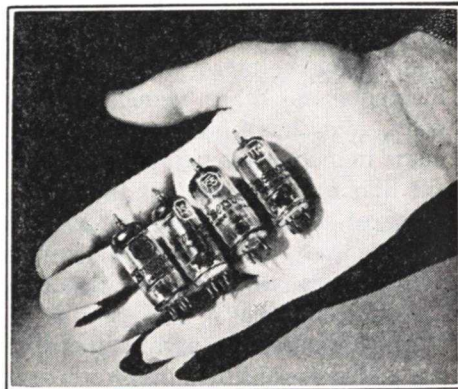

Courtesy Emerson Radio & Phonograph Corp.

The relative size of miniature tubes is shown here—four are held in the palm of a hand.

(Many materials are good insulators at low frequencies but become poor insulators at the frequencies used for television and f.m. broadcasting.)

► Hearing aids and the extremely small portables use miniature tubes, only $\frac{3}{4}$ inch in diameter and less than two inches high. Actually, these tubes have no true base; the glass-bulb bottom is flattened and has a ring of holes. The prongs (really just connecting wires, like those of a loctal tube) come through these holes, which

are placed at the proper points to fit the socket.

Top Caps. The first tubes had all connections made at the base. However, when the need for reduced grid-to-plate capacity was recognized, tubes were developed with a terminal in the form of a metal cap at the top of the glass or metal envelope, in addition to the prongs or pins. Connect-

capacity, so many tubes are now made with the control grid lead going to one of the prongs in the base. This is now possible because a special type of base construction is used to shield the electrode leads and prongs from each other and so reduce lead capacities. These tubes (called single-ended tubes because all connections are at the same end) permit all connections

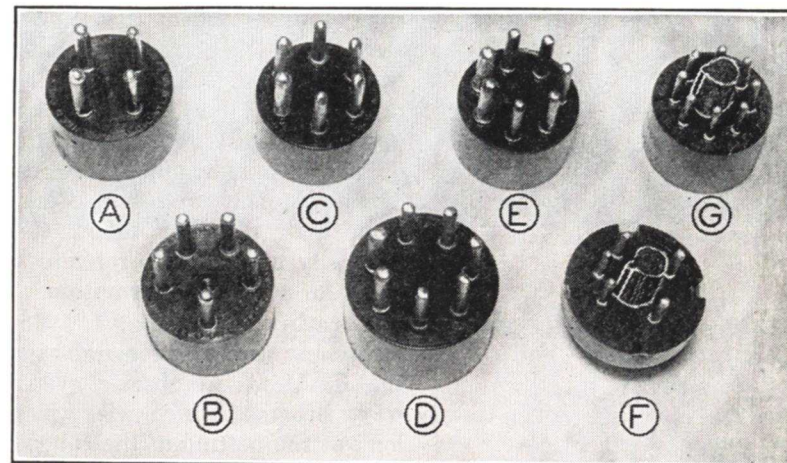

FIG. 35. Representative tube bases, showing standard prong arrangements A—a 4-prong base; B—a 5-prong base; C—a 6-prong base; D—a large 7-prong base; E—a small 7-prong base; F—an octal base having only 5-prongs; G—an octal base having all 8 prongs.

ing the grid to the cap makes possible a maximum spacing (and therefore a minimum capacity) between the grid and plate leads. Connections are made to this cap (usually called the top cap or grid cap) by a top-cap clip. A flexible wire lead connects this clip directly to some part in the chassis of the radio apparatus; the clip must naturally be removed before the tube can be removed from its socket.

Single-Ended Tubes. The top cap connection is not too desirable from a mechanical standpoint, as loose connections frequently develop. Tube manufacturers discovered a means of eliminating the top cap without a great increase in the grid-plate ca-

to be made underneath the chassis, simplifying the wiring and eliminating long leads through the chassis to the top cap. These tubes have either octal or loctal bases, so that they fit the corresponding socket.

PRONG IDENTIFICATION

After base types and sizes of tubes were standardized, it became possible to number the prongs and socket clips

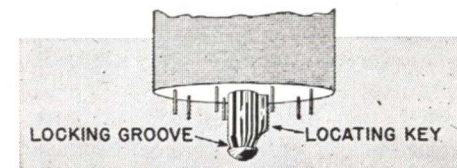

FIG. 36. The locking groove on a "loctal" base.

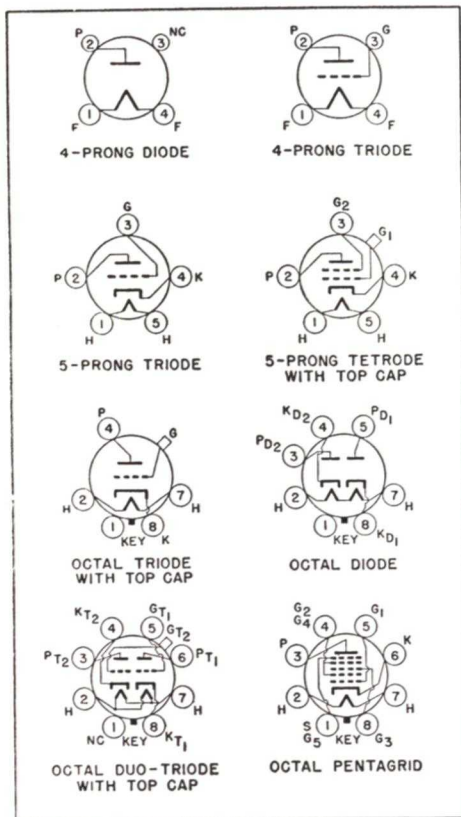

FIG. 37. These schematic symbols not only show which elements go to which prongs—they also show the relative positions of the prongs. Notice that the octal bases may not have a full set of 8 prongs but when prongs are missing, the others maintain their original spacing and numbers. These connections are correct when viewing the **BOTTOM** of the base or tube socket but are proper just for **CERTAIN TUBES**. Always consult a tube chart to determine the connections on tubes.

so as to identify the element connections. A standard system was developed by the Radio Manufacturers Association (R. M. A.) for this purpose. Looking at the bottom of the socket, the numbers progress *clockwise* around the socket. Examples showing the element connections for several tube types are shown in Fig. 37. These numbers are in order when you look at the *bottom* of the socket, because this is the normal position for radio servicing.

Locating Filament Prongs. In 4, 6, and 7-prong tube standard bases, those two prongs having the highest and lowest numbers are made larger than the others, to insure that the tube is always inserted in its socket in the correct position. For example, pins 1 and 4 of a 4-prong tube would be larger than the others; these thicker prongs are always connected to the filament. In the standard 5-prong tube, all pins are of the same diameter but are so arranged that there is only one way of inserting the tube; pins 1 and 5, the filament prongs, are always close together and directly opposite a single pin. The positions of the filament prongs in octal tubes vary with different tubes, so it is generally necessary to refer to a tube chart for accurate information.

Locating Prong No. 1. You can locate any prong by remembering that the R. M. A. numbering system always progresses clockwise when you look at the bottom of the tube socket. In octal tubes, prong 1 is always in the clockwise direction from the aligning slot as you look at the bottom of the octal tube socket. Notice the examples given in Fig. 37.

TUBE TYPE NUMBERS

Since it is clearly impractical for busy radiomen to describe a certain tube completely when speaking of it, each tube has been assigned a number. In the early days of radio, when only a few different types of radio tubes existed, there was little confusion even though numbers were assigned to new tubes in haphazard fashion; tubes such as the 01A, 12, 26, 71A, 56, 58, and 24 are examples. Notice that these numbers give no indication of the characteristics of the tubes. As the number of different types of radio tubes increased, it became increasingly more difficult to recognize

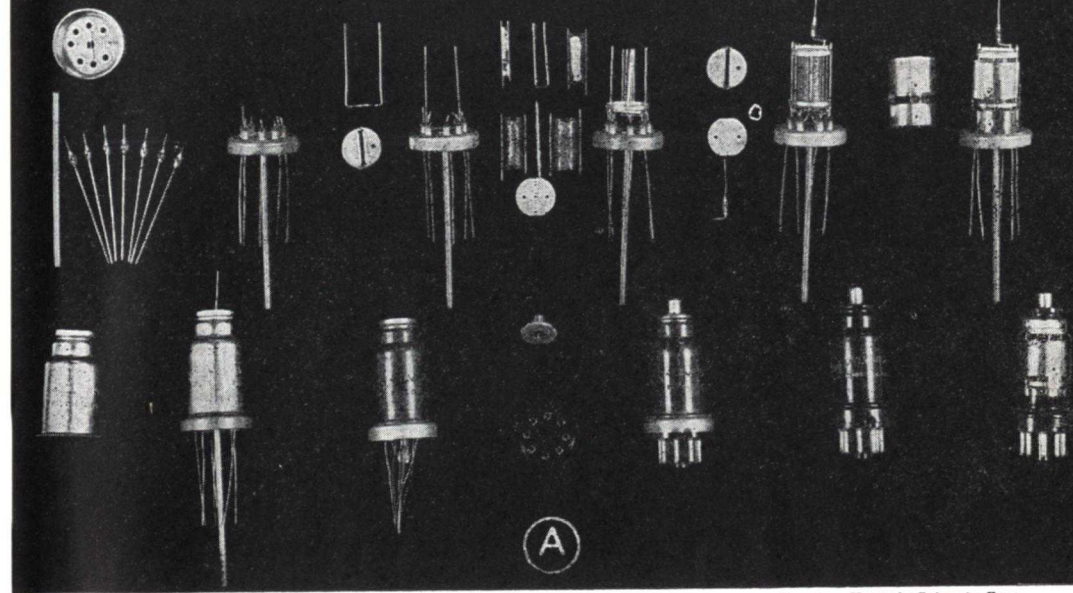

Courtesy Hygrade Electronics Corp.

A (above). The assembly of a typical all-metal tube, the type 6A8 pentagrid converter, can be traced in the above photograph. Metal exhaust tubing and Fernico metal eyelets are welded to metal header shown at upper left, then glass beads with wire leads are threaded through eyelets and fused to them. Electrodes are welded to projecting leads, metal envelope is welded to header, tube is evacuated and sealed off, octal bakelite base and top cap are crimped into position and tube is sprayed, completing job. A completed tube with half of envelope cut away is also shown.

B (at right). This unusual drawing, giving a cut-away view of an all-metal tube, shows how connections are made to electrodes and how electrodes are mounted inside.

C (at left). Cut-away view showing arrangement of electrodes inside a 6Q7 all-metal duplex diode triode.

D (below). Cut-away view of 6H6 all-metal twin diode, a radio midjet.

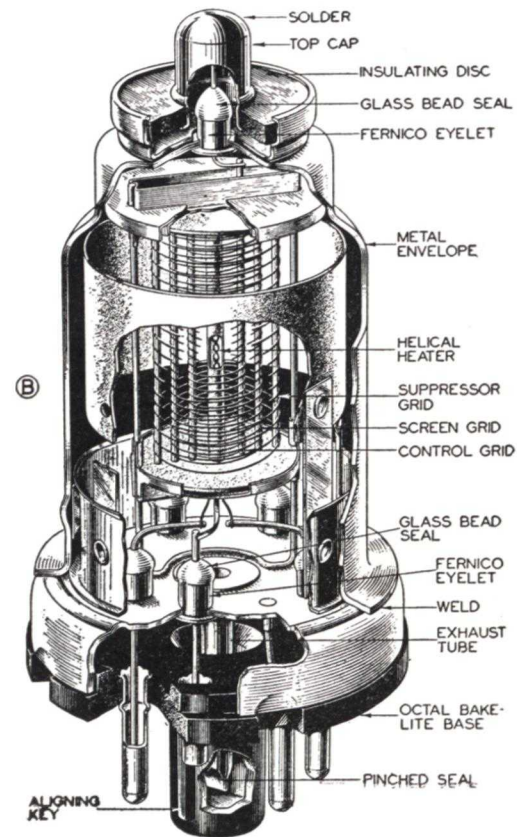

Courtesy National Union Radio Corp.

Courtesy R.C.A. Manufacturing Co., Inc.

tubes. The following code, which is now standard for all new tubes, was developed by the R. M. A. to eliminate some of this confusion, as this code gives at least *some* clue to the tube type.

R.M.A. TUBE NUMBERING CODE

Each tube designation shall consist of a number (or digit), followed by a letter, which is in turn followed by another digit.

(a) The first numeral (or group of numerals) shall indicate the *filament voltage* in steps of 1 volt, using 1 to mean any voltage below 2.1; 2 to mean 2.1 to 2.9 volts; 3 to mean 3.0 to 3.9 volts; 4 to mean 4.0 to 4.9 volts; 117 to mean 117.0 to 117.9 volts, etc.

(b) The last numeral shall designate the number of useful elements (filament, cathodes, grids, plates, etc.) which are connected by wire leads to prongs or the tube cap. The filament is here counted as one element, and the envelope of a metal tube (or a shield within a glass tube) is considered as one element.

(c) The letter between the numerals shall be a serial designation which will serve to distinguish between tubes having the same number of useful elements and the same filament voltage. Rectifiers will start with Z and work backward through the alphabet, while all other tubes start with A and work up through V of the alphabet. When all 26 letters of the alphabet have been used for a given combina-

tion of first and last numbers, the next 26 new tubes with these numerals will have the letter A ahead of the serial designation letter; succeeding groups of 26 tubes will have B, C, D, etc., ahead of the serial designation letter. Examples: 6AB5; 6AF6.

(d) The letter S ahead of the serial designation letter (following the first numerals) indicates a single-ended tube. Example: 6SK7. The letter G following the last numeral indicates an octal-base tube having a standard glass envelope instead of a metal envelope. Example: 6Q7G. The letters GT following the last numeral indicate an octal base tube having an extra-small glass envelope instead of a metal envelope. Example: 6Q7GT.

► **The foregoing system is primarily intended to be a logical system of assigning tube numbers in such a way that *some* useful information can be conveyed to the user. However, a tube chart must be used to find the filament current, plate, and grid voltages, plate current, amplification factor, prong connections, etc.** Tubes are listed in such charts by their numbers, so you need merely look up the number of the tube in which you are interested to find its characteristics and recommended uses. Furthermore, tube charts give the tube base connections, so it is possible to find from them which prong is connected to which element. We will give more information about tube charts elsewhere in your Course.

Lesson Questions

Be sure to number your Answer Sheet 8FR-4.

Place your Student Number on *every* Answer Sheet.

Most students want to know their grade as soon as possible, so they mail their set of answers immediately. Others, knowing they will finish the next Lesson within a few days, send in two sets of answers at a time. Either practice is acceptable to us. However, don't hold your answers too long; you may lose them. Don't hold answers to send in more than two sets at a time or you may run out of Lessons before new ones can reach you.

1. What two electrodes must *every* electronic tube have?
2. Will electrons flow through an electronic tube when the anode is *negatively* charged with respect to the hot cathode?
3. Does the A battery furnish the electrons that are emitted by a heated filament?
4. Suppose an a.c. voltage source is connected between the plate and the cathode of a diode thermionic tube. Will the resulting plate current be: 1, a.c.; 2, pure d.c.; or 3, pulsating d.c.?
5. Is a tube which has an indirectly heated cathode called a *heater type* tube or a *filament type* tube?
6. What is secondary emission?
7. What is the purpose of the control grid which is placed between the cathode and the anode of an electronic tube?
8. Does the plate current: 1. remain constant; 2, decrease; or 3, increase; as the C bias voltage is made more negative?
9. How many elements are there in a pentode tube?
10. What does the first numeral (or group of numerals) in the R.M.A. Tube Numbering Code indicate?

4-3-58



YOU HAVE AN AIM IN LIFE

When you enrolled as a student member of the National Radio Institute, you took the first step on your road to success and happiness. You now have a *goal* for yourself—you have an aim in life—you are looking forward to the sort of work you like, the sort of income you want, and the respect and admiration of your friends.

Keep your goal in mind. Never forget it for a moment. Of course you will have your moments of discouragement—we all have. But if you make a thorough search for the cause of your discouragement, you will most likely find that you ate something which did not agree with you, or were kept awake last night by the neighbor's dog.

Whenever you are tempted to neglect your studies, say to yourself: "I have a goal to reach and I'm going to reach it." Think how unhappy you would be if you did not have this goal. There is nothing as pathetic as a rudderless ship or a man without an aim in life.

Here's to success and happiness—*your goal*.

J. E. Smith