

**TRANSMITTING TUBES  
AND THEIR RATINGS**

*Finished 12-16-59*

30RC

**NATIONAL RADIO INSTITUTE**

ESTABLISHED 1914

**WASHINGTON, D. C.**





# STUDY SCHEDULE NO. 30

For each study step, read the assigned pages first at your usual speed. Reread slowly one or more times. Finish with one quick reading to fix the important facts firmly in your mind, then answer the Lesson Questions for that step. Study each other step in this same way.

- 1. Why Transmitting Tubes Differ from Receiving Tubes . . . Pages 1-4  
Here you learn about the power requirements of transmitters, and how the power dissipated in the tube determines the tube design.
- 2. Construction of Transmitting Tubes . . . . . Pages 4-8  
The high emission and high heat levels found in transmitting tubes require careful choice of cathode and grid materials. Troubles with gas molecules prevent the use of oxide-coated and thorium-coated filaments in the highest powered tubes, so only tungsten filaments are found in these tubes. Answer Lesson Question 1.
- 3. How the Anode Is Constructed and Cooled . . . . . Pages 9-16  
Here is information on the many materials used in constructing transmitting tube anodes. You learn the advantages and disadvantages of these materials, and also how air and water are used to cool the largest tubes. Answer Lesson Questions 2, 3, 4, 5, and 6.
- 4. Frequency Limitations . . . . . Pages 16-20  
This is a preview of the tube types you will study in later Lessons on microwaves. You learn why it is necessary to change radically the physical shape of tubes at higher frequencies, and how eventually frequencies are reached at which it is necessary to go to radically different tube structures.
- 5. Transmitting Tube Charts . . . . . Pages 21-28  
From tube charts you can determine almost anything you want to know about a tube, providing you understand what the ratings mean. This important section explains about the maximum ratings, the typical operating values, and the information on cooling that is given in tube charts. Answer Lesson Questions 7 and 8.
- 6. Definitions For Rectifier Tubes . . . . . Pages 29-33  
This section extends the previous one to rectifier tubes, which have many special ratings.
- 7. Handling and Conserving Transmitting Tubes . . . . Pages 33-36  
Practical facts about storing, handling, and installing transmitting tubes. This is an extremely valuable section to the radio operator. Answer Lesson Questions 9 and 10
- 8. Start Studying the Next Lesson.

# TRANSMITTING TUBES AND THEIR RATINGS

## Why Transmitting Tubes Differ From Receiving Tubes

THE physical design of radio tubes is of importance to both the radio engineer and to the operator-maintenance man. The engineer is interested in the choice of the proper tube for a particular purpose, and the operator is charged with the duty of operating his equipment so as to give maximum tube life with a minimum of service interruptions. As an example, tubes with *thoriated tungsten* filaments must be operated with filament voltages held *very* close to the rated values, but those with pure tungsten filaments may have their life almost doubled by operating the filaments at a voltage 5% *under* their rated values. Whether this is permissible depends on the emission obtainable at this reduced voltage, and whether high peak plate currents are demanded. These latter are considerations for the engineer, but once decided, the operator must intelligently follow the instructions furnished him — he

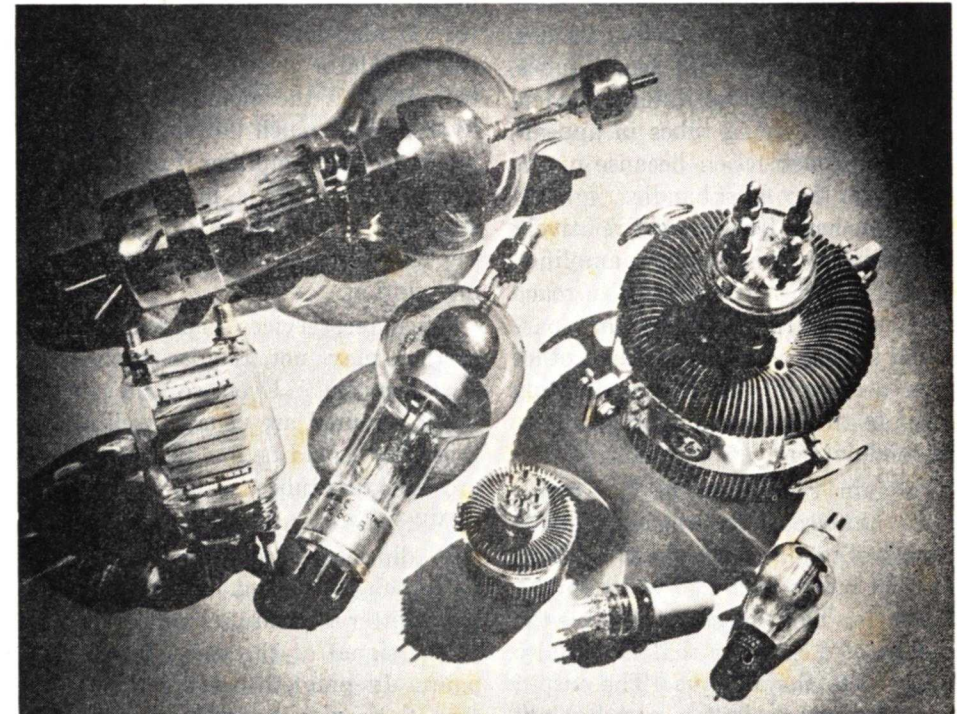

Several typical transmitting tubes.

Courtesy General Electric Co.



should know *why* he does certain things.

On many transmitters, the operating potentials are fixed, and there is no adjusting to be made. However, on others the operator can control voltages, and must know what values should be used on the tubes in that equipment. Where can one learn about the tube's characteristics? From a tube chart or data book. But first, one must know more about how the different materials used in tube construction affect the characteristics.

This Lesson, therefore, deals with the construction of transmitting tubes, and then goes on to explain in greater detail how to get useful information from tube data. First, though, let's see why transmitting and receiving tubes differ.

► Transmitters use essentially the same basic types of tubes as are found in radio receivers — diodes, triodes, pentodes, tetrodes, and beam tubes. However, these tubes differ considerably from receiving tubes in appearance and construction because of the high power they must handle.

As you have learned, the relatively low output of an oscillator is amplified many times in a transmitter to reach the power level needed by that particular service. At the same time, other tubes are amplifying the modulating signal to the level necessary to excite the modulator.

To gain some idea of the power levels handled, let's consider broadcasting. Standard broadcast stations range in power from 250 watts to 50,000 watts. This power rating gives the amount of a.c. power that is actually delivered to the antenna. The output of a standard oscillator may be only about 5 or 10 watts, and its output

power must be raised to the level required at the antenna. Thus, to raise 5 watts to 50,000 watts, we must have a power gain of 10,000. Intermediate stages, therefore, must step up the power in rather large steps. A typical chain might well raise 5 watts to 50 watts, 50 to 500, 500 to 5000, and 5000 to 50,000 watts.

The output of the oscillator tube is the only power level in this chain that compares at all with the power handled in home radio receivers. Therefore, the oscillator tube and perhaps the next one are the only ones that could be types that may be found in a home radio receiver. All the others must be modified to handle the power level at their particular positions in the amplifier chain.

► In the case of the modulating signal amplifier, voltage amplifiers are used up to the driver stage for the modulator. If high-level modulation is used, the modulator must be fairly powerful too. In fact, the modulator must deliver half as much power as does the modulated r.f. amplifier if plate modulation is used. Thus, in a 10,000-watt station, the modulator tube must supply 5000 watts of power on peak modulation.

Of course, services other than broadcasting may not require such high power output. Even so, the power levels required are usually well above those that could be handled by standard receiving tubes.

► Why are such high powers needed? All radio communications depend upon there being sufficient output from the transmitter to insure reliable reception of the signal at the desired receiving point. In point-to-point communication, there may be only one receiver, and it may be half-way around the

earth. The broadcast station covers a specified nearby *area* with its signal. In either case, the stronger the signal coming from the station, the more the signal can over-ride local noise and man-made interference, and thus the more reliable will be the reception from that station. Interference between stations is also reduced, because if the desired signal is powerful enough, it can mask interfering signals.

Of course, if stations were allowed to radiate just *any* power, many would make their signals so strong that they would blanket wide areas and prevent reception of stations having a frequency even close to that of the powerful station. For this reason, one of the functions of the Federal Communications Commission is to assign operating frequencies, *and power levels*, which will give the desired service, without creating too much interference with other services.

### FACTORS DETERMINING POWER OUTPUT

We must always remember that any signal power coming from a tube stage has been converted from the plate supply power of that stage. Therefore, whenever we say that the output of a station is 10,000 watts, we mean that 10,000 watts of signal power comes from the station, so the B supply for the final stage must supply this power, plus that lost in the tube plate resistance (and other losses). Hence, in each stage, the signal power delivered to the next stage, or to the antenna, plus that power lost in the stage, equals the product of the B supply voltage and the average plate current. The only way that we can increase the amount of power output from a stage is to design that stage to handle higher

plate voltages or higher plate currents, or both.

**Efficiency.** Before we can consider exactly how much power must come from the B supply, we have to know something about the efficiency of the stage operation. As you have learned, class A amplifiers have efficiencies of only about 30%, but that class C amplifiers go on up to a possible efficiency of perhaps 70 or 80%. As an example of what this means, let's suppose the final stage of a 10,000-watt transmitter is 60% efficient. This means that the 10,000 watts output is 60% of the power taken from the B supply, so the latter must be 16,600 watts. The difference between the supply power and the radiated power is 6,600 watts, which is the power that is dissipated in the tube and in the circuit losses.

The same example can be used for other stages, whether of lower or higher power. Thus a 50-watt stage that is 50% efficient draws 100 watts from its plate power supply. This indicates one reason why it is so important to operate at the highest possible efficiency. At high power levels, the amount of electrical power taken begins to cost real money and the transmitter must be designed to deliver just as much of this power as an output as is possible. Furthermore, as higher and higher power is needed, the efficiency becomes even more important, because there are definite limits to the amount of dissipation that is permissible in tubes. We will go into this in more detail later.

► Since the power is the product of voltage and current, one of the obvious ways of obtaining a greater power is to use a higher voltage. This is done in transmitting practice. Of course, this means that the tubes must be designed to withstand higher voltages



without flash-over between the elements, and the coils and condensers used must have sufficient insulation to prevent short circuits between parts and the chassis. However, there are practical limits to increasing the voltage; further increases in insulation are costly, and excessively high voltages are dangerous. Therefore as a practical limit, 20,000 volts is about the highest that is found in any transmitting equipment, even the most powerful. More usually, stations with power outputs from 10,000 to 50,000 watts use plate voltages on the final amplifier of 10,000 to 12,000 volts, while those of lower power normally use plate voltages ranging from 1000 to 5000 volts.

With this practical limit on the plate voltage, the plate current must be increased to supply the necessary power. If a 10,000-watt final stage is drawing 15,000 watts from the B supply, and the plate voltage is limited to 10,000 volts, then the plate current must be 1.5 ampere. Compare this current

with the 50 to 60 milliamperes (.05 to .06 ampere) drawn by the average large receiver power tube! Some of the most powerful transmitting tubes draw plate currents as high as 8 to 10 amperes. And this is just the current of the final power amplifier—the intermediate amplifiers draw lower plate currents, but they are still appreciable. This means that the rectifier tubes in the power supply must be capable of passing high currents. The average current rating for the more powerful mercury vapor rectifiers runs from 2 amperes to as much as 75 amperes.

Essentially, therefore, transmitting tubes are of basic types that are similar to receiving tubes, but they are different in their construction in order to withstand higher plate voltages, and in general they pass much higher plate current. The higher power level handled means that the tubes must be designed to get rid of the heat developed within them, and as you will shortly learn, they must be constructed so as to be free from gas troubles.

## Construction of Transmitting Tubes

To handle the wide variation in powers required in different stages of transmitters, there are a number of transmitting tubes of differing physical sizes and characteristics. The lowest powered types are merely enlarged versions of receiving tubes; those in Fig. 1 are typical.

However, as we go up the power scale, the problem of getting sufficient emission requires very much enlarged cathode and filament structures. These in turn increase the size of the other elements physically. Also, the in-

creased filament power necessary to get the emission means that there is much more heat developed within the tube. In addition, the higher plate currents heat the plate of the tube. In fact, so much heat is developed at the plate that it is standard practice to run the lower powered transmitting tubes with the plate heated to such an extent that it glows red.

As more and more power is demanded, the problem of getting rid of this heat at the plate becomes more pressing. Naturally, if the plate metal gets

hot enough, it will begin to emit just like the filament. This must be prevented. Furthermore, the high temperature causes the plate material to release gasses which may have been bound in the pores of the metal. This must be avoided as much as possible. Finally, we reach the actual physical limit of the plate materials to withstand heat without melting.

As the tube gets larger, the plate must actually be cooled by direct streams of air or even water, as we shall show in this Lesson. Now, with these basic facts in mind, let's study more carefully the details of construction of the cathode, grid, and plate.

### CATHODE CONSTRUCTION

The cathodes used in transmitting tubes are basically like those in receiving tubes — emission may come from a filament directly, or the emission may be from an indirectly heated cathode. Also, there are three types of cathodes: oxide coated; thoriated tungsten; and plain tungsten.

**Oxide-Coated Cathodes.** Practically all indirectly heated cathodes are coated with rare earth oxides such as barium oxide or strontium oxide. These cathodes usually are a nickel alloy base material with a relatively thick coating of the oxide. These make very efficient cathodes and need to be operated at a temperature of only about 750° Centigrade (dull red) to produce a copious supply of electrons.

These heated cathodes consist of a sleeve with a heater element inside. The heater element is usually made of tungsten wire, or a tungsten-molybdenum alloy. Since it is insulated from the heater filament, the cathode surface is all at the same potential—it

has no voltage drop along its length due to heater voltage.

The advantages of a coated cathode are: a low hum level; low operating temperature; and high emission efficiency. High emission efficiency at low operating temperature is also an advantage of a filament that is coated with the oxide. However, oxide-coated

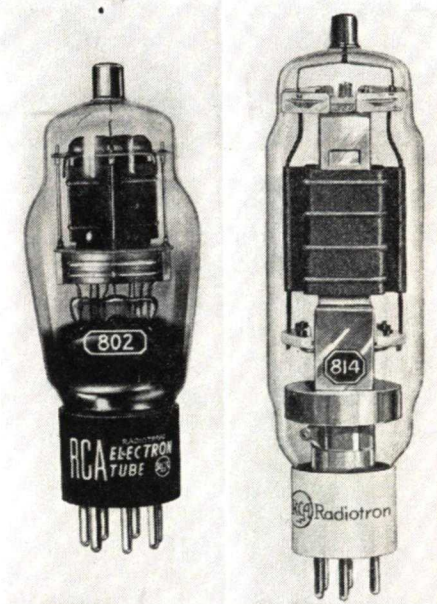

Courtesy RCA

FIG. 1. These tubes are typical of the smaller transmitting tubes. They are similar to receiver power tubes, except that they are larger. Also, to provide insulation for the high plate voltages, the plate terminal is at the top of the tube, well away from the grid and filament connections on the base.

cathodes have disadvantages. An important one is the tendency of the oxide to evaporate and condense on other electrodes in the tube, so that these electrodes also become emitters. In addition, the coating is easily knocked off by bombardment by positive ions from residual gases that may remain in the tube. These two disadvantages limit the oxide-coated type of cathode to receiving tubes and low-voltage



(low-power) transmitting tubes only.

**Tungsten Cathodes.** Pure tungsten may be used as the electron emitter only when the filament itself does the emitting, because of the high heat requirements. It is necessary to operate

Despite this, tungsten filaments are widely used because of their ability to withstand ion bombardment at high voltages, their great ruggedness, and their ability to withstand electrical abuse.

The ion bombardment is the result of gas molecules being ionized because the plate current electrons strike them, knocking out electrons that flow on to the plate. The positive, heavy ions go to the cathode and bombard it.

It doesn't matter if the tungsten filament is struck by the positive ions, because emission is a characteristic of the metal itself, and so, even if some of the surface is knocked away, there will still be emission. On the other hand, a coated cathode will cease emitting when the coating is knocked off.

This trouble is most severe at higher operating voltages, so tungsten filaments are the only kinds that can be used on the very high-voltage transmitting tubes, particularly the large ones which require forced-air or water cooling.

The extreme ruggedness of tungsten filaments makes them particularly important in those tubes that are required to withstand severe shock and to be especially rugged.

The tungsten filament is relatively unaffected by peak plate current demands as it has no specialized emitting surface to be torn away. It is practicable to operate them well into the region of temperature saturation at which practically all the emitted electrons are attracted to the plate. Excessive filament voltage will reduce tube life, however.

#### Thoriated Tungsten Cathodes.

Thoriated tungsten filaments are made by having the wire drawn from tungsten blocks which have been im-

pregnated with thorium. In processing this filament, a surface layer of thorium is formed, and this surface layer is a source of electron emission. The use of this layer permits proper emission at about 1700° C (a bright yellow), and therefore, thoriated tungsten filaments are more economical of filament power than are pure tungsten types.

Unlike bright tungsten filaments, thoriated tungsten filaments should never be operated at or near saturation, and the peak plate current should not exceed more than one-half of the maximum of which the filament is capable of emitting. To prevent this, these filaments are designed to provide at least double the emission that might be needed in any normal class of operation.

Thoriated tungsten filaments are not used in tubes operating at extremely high voltages, because the surface layer of thorium may be knocked off by ionic bombardment. However, these tubes possess an advantage not obtainable from the oxide-coated type in that these filaments can frequently be reactivated after their emission has been partially lost because of a temporary overload. To restore the activity, the filament is operated at its rated voltage for 10 minutes or more, with no voltage applied to the other electrodes. This reactivation process may be accelerated by raising the filament voltage about 20% above its normal value for a few minutes. This operation drives a new layer of thorium from within the filament to its surface, to replace that which has been lost. Even so, the thoriated tungsten filament is used only in the intermediate power tubes.

► In general, the cathodes of trans-

mitting tubes are far larger than those of receiving tubes, and draw much higher currents. Some of the largest transmitting tubes actually have two or three entirely separate filaments, operated in parallel, to make a more economical supply connection possible. This is discussed later in this Lesson.

#### GRID CONSTRUCTION

The metals and alloys that are used for grid construction should have a reasonably low gas content, should be easy to get gas out of, and should have good mechanical strength, especially at high temperatures.

Few people realize that metal objects have pores that are capable of

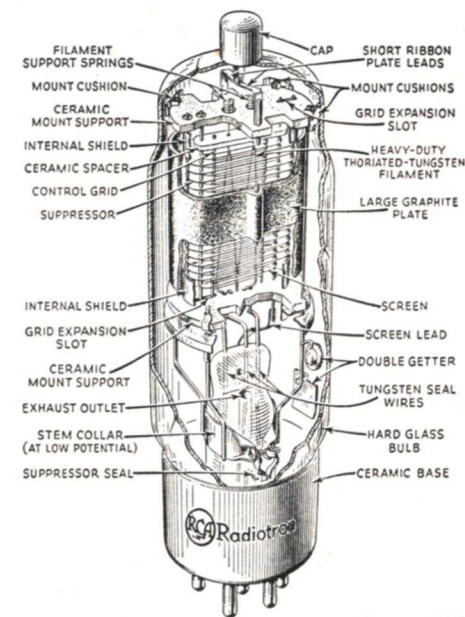

Courtesy RCA  
A cut-away of a typical beam power transmitting tube, the type 813.

holding a considerable amount of gas. In fact, some metals even have an affinity for gas and appear to collect certain kinds. This is all right—it may even be desirable—as long as the

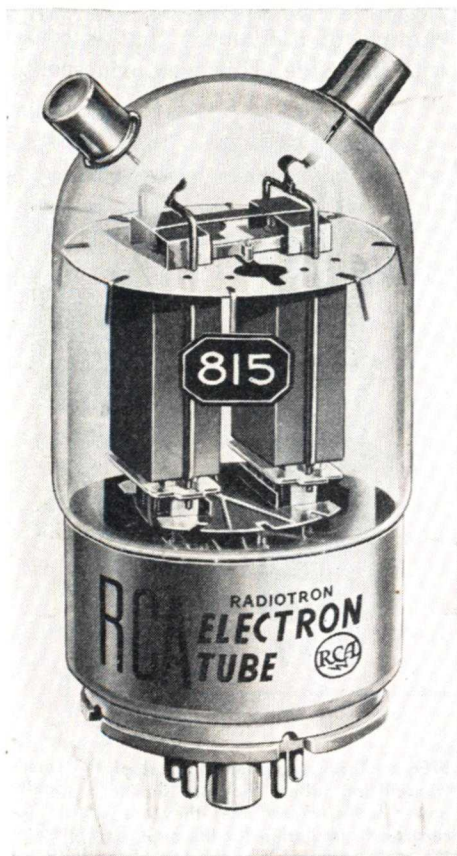

Courtesy RCA

This is a dual transmitting tube. Two beam power tubes are in this one envelope, thus providing a convenient tube assembly for push-pull applications.

a tungsten filament at a temperature of 2500° C (white heat) in order to get sufficient electron emission. Thus, tungsten filaments have a low emission efficiency (or electron emitting ability) for a given amount of heat energy input. The high temperature at which tungsten filaments operate presents a heat dissipation problem.



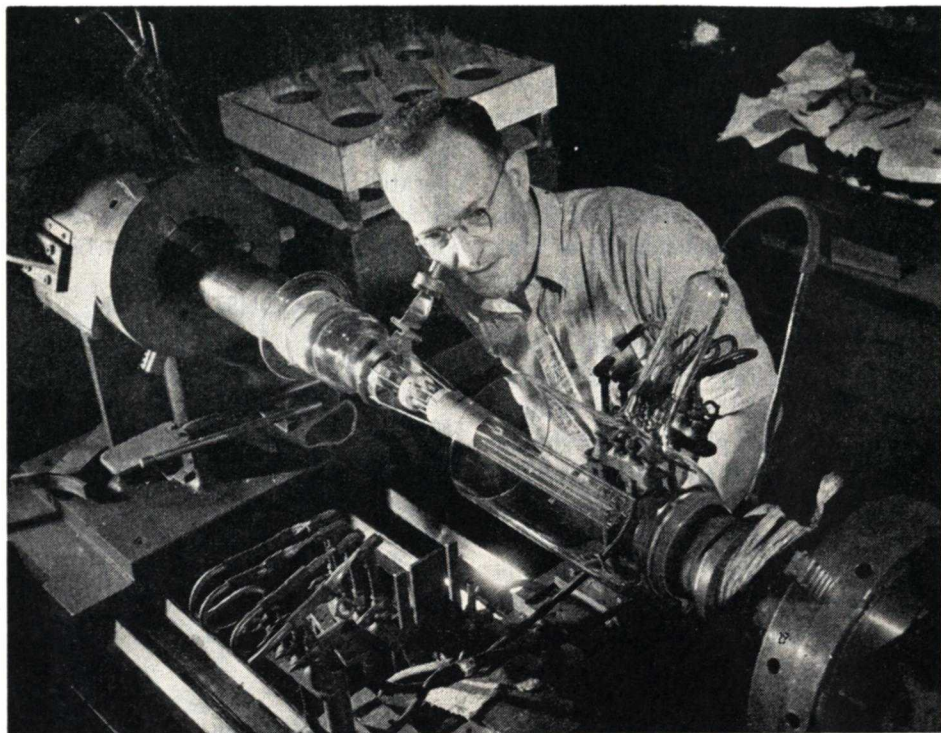

Courtesy General Electric Co.

Inserting the filament and grid assembly in a large 50-kilowatt transmitting tube.

metal will continue to hold on to this gas even after the tube has been evacuated and is operating. However, if the metal has a tendency to hold on to gas but then gradually releases it over a period of time, the tube eventually will become excessively gassy. This is definitely undesirable.

Since the grid is physically near the cathode, and is surrounded by the heated plate, it is particularly important that it be able to hold its original shape under high temperatures. A very small change in grid-cathode spacing, caused by a change in the shape of the grid structure, will have a relatively large effect on the tube characteristics.

A very important consideration in the choice of the grid material is its

emission characteristics. In most types of r.f. service, the grid is driven positive during part of the time, so electrons from the cathode bombard it. Some of these electrons are likely to knock others out of the grid structure. This emission as the result of electron bombardment is known as *secondary* emission. Equally important, we must avoid the *primary* emission that may occur because of the high grid heat. Otherwise, it will become a second cathode and will emit, definitely upsetting tube operation.

To overcome these troubles, the grids are sometimes pre-coated with a material that does not readily emit and the grid and tube assembly are kept especially clean while the tube is being assembled.

## How the Anode Is Constructed and Cooled

If a tube could be made 100% efficient, so that no power was lost in the plate resistance, then we would only have the heat from the filament to worry about. Although this is enough of a problem, the greatest trouble is in the heating of the plate itself.

As you know, a certain amount of the plate-supply power is lost in the tube. This power is dissipated from the plate in the form of heat. That is, the electron bombardment of the plate causes it to become hot.

The percentage of the plate supply power that is lost in the tube this way depends on the efficiency of operation, and therefore on the class of operation. Thus, for class C operation, a smaller percentage of the plate supply power is dissipated in the tube and more of it is obtained as output power. Therefore, for a particular amount of output power, we have to use a tube capable of dissipating more heat when the operation is less efficient.

Another consideration is that of whether the tube is in operation continuously or only intermittently so. Continuous operation, such as is obtained from broadcast stations and others which constantly radiate a carrier, means that power is constantly lost at the plate. Intermittent operation, on the other hand, such as may be obtained in code transmitters which are cut on and off by the code keying, or by any service that demands only that the transmitter be on for very short periods of time, may operate at higher dissipation ratings. That is, as long as the tube can handle the high peak currents for short periods of time, the power dissipation may exceed the

normal rating of the tube for short periods of time.

Pulse transmission, such as is used in radar, is another example of an intermittent service. Here, the transmitter furnishes very high peak powers, but only for *very* short periods of time, with the result that the tube's average power dissipation is kept within reasonable limits.

Let's start our study of anode (plate) construction by moving from receiving type tubes up to the highest powered types.

### MATERIALS FOR LOW-POWER PLATES

The amount of heat a plate can dissipate depends on its area, the composition of the surface, and its color. The lowest powered transmitting tubes merely have larger plate areas, and depend upon radiation to the envelope for cooling.

These plates may be made of dark-colored metals such as tungsten, molybdenum and tantalum. Nickel is also sometimes used. However, better heat dissipation is obtained if the anode is dark colored. Shiny metal surfaces reflect heat and do not make good radiators of heat. Remember that the plate is heated from inside out, so a shiny surface tends to hold the heat inside the plate. When nickel is used, its surface is usually darkened by depositing a layer of carbon on it.

Of these materials, tungsten can withstand the highest temperature—it can be run red-hot—but it is the hardest to form into the desired shapes. Molybdenum is easier to form but does not have as great a heat-dissipating



ability. When molybdenum is used, fins are sometimes added to the plate as shown in Fig. 2. This greatly enlarges the radiating area of the plate structure so more heat can be dissipated.

Tantalum is similar in appearance and characteristics to molybdenum. The principal advantage of tantalum is its ability to "clean up" or absorb gases. Further, it does not release these gases readily when heated.

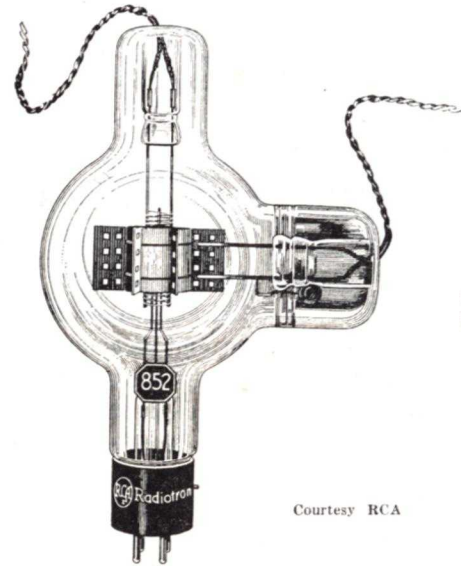

Courtesy RCA

FIG. 2. The molybdenum anode in this tube has fins attached to it to increase its heat-dissipating ability.

Any of these plates may be coated by zirconium, which gives a rough, dark surface and is also a good gas absorber. However, this coating may flake off unless carefully applied.

► Some transmitter tube plates are made of carbon or graphite, which can be machined easily, and once machined keeps its shape. It is black in color which means it is a very efficient radiator, has a primary electron emission of nearly zero, is a very plentiful substance, and has good thermal conductivity properties. Although graphite contains considerably more absorbed gases than either tungsten or molyb-

denum, these gases can be largely removed by suitable pre-treatment of graphite anodes before the tubes are assembled and processed.

Compared with metal anodes, graphite anodes are more efficient radiators and so operate at a visibly lower temperature for the same power dissipation. In some transmitting tubes employing tungsten, molybdenum, or tantalum anodes, the operating efficiency can be judged by observing the

color of their anodes, since at normal operating temperature these anodes are distinctly cherry or orange-red in color. However, tubes with graphite (carbon) anodes cannot be judged this way, for they show practically no color during normal operation.

#### Envelope and Base Construction.

In the tube types discussed so far, heat is dissipated by radiation from the plate to the tube envelope, and hence to the surrounding air. The glass used in bulbs for transmitting tubes must have good mechanical strength, be a good insulator, should be easily freed of absorbed gases, and must withstand

high temperatures. When the heat dissipation requirements are not too high, soft glass (i.e., the kind used for receiving tube bulbs) can be used. However, for the larger air-cooled and water-cooled types, hard glass is employed. Hard glass softens at about 750°C, whereas soft glass softens at about 625°C.

As the tube power rating goes up, it is necessary for the tube to be mounted in free air so that the envelope can radiate the heat from its surface. Eventually, tube types are reached where forced-air drafts are desirable for cooling them. However, forced air should never be used except on a tube that is specifically designed for it. Unless correctly applied, a draft of cold air can easily crack the tube envelope. The cooling must be evenly distributed over the bulb, and the bulb must be specifically designed for this type of cooling.

As a practical point of transmitter design, no wires or other objects are ever allowed to touch the glass envelope of the tube, because of the possibility of heat conduction from the one spot, thus giving an uneven heat distribution over the glass envelope and possibly causing it to crack.

► Bases, where used, are either ceramic or plastic. Among the ceramic bases are glass and porcelain, and Bakelite is the most commonly used plastic. Some of the newer plastics, such as Micanol, are being employed more frequently, for they exhibit lower radio frequency and leakage loss characteristics than either Bakelite or ceramic.

#### FORCED-AIR AND WATER COOLING

As higher and higher powers are

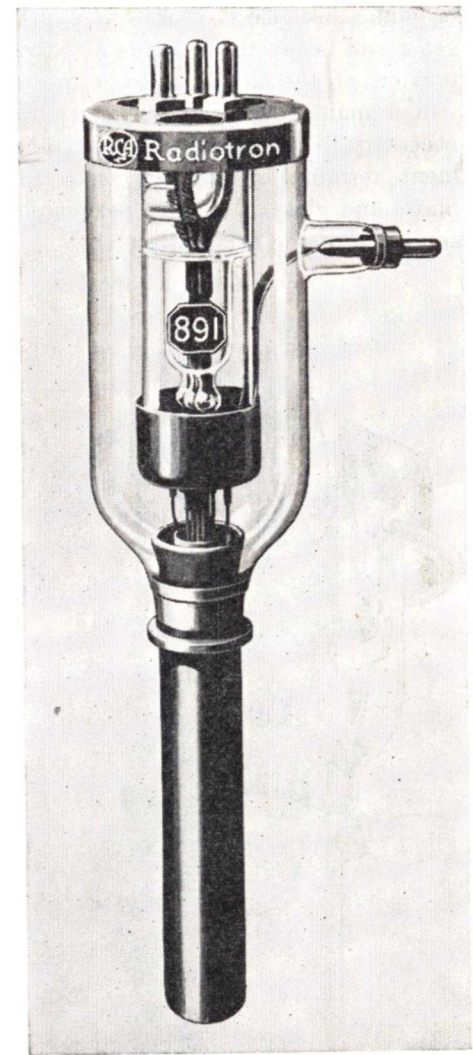

Courtesy RCA

FIG. 3. This is a typical water-cooled tube, having the anode on the outside, filament connections at the top, and the grid connection at the side.

needed, the tube design eventually reaches a point where it becomes impractical to depend on radiation from the plate to the envelope and hence from the envelope to the surrounding air. The next step in transmitting tube design is to make the plate of the tube part of the envelope, as in Fig. 3. It was a long time before this step could



be made, because it was necessary to get a seal between the anode and that portion of the glass envelope which still remains. (An envelope is still necessary to insulate the grid and filament terminal connectors from the plate, and glass is used to permit observation of the tube interior.)



Courtesy RCA

FIG. 4. Cut-away of the 9C21 water-cooled tube.

Several advantages are possible with this method of construction. Copper can be used for the plate, and copper is an exceptionally good heat conductor. With the plate on the outside, it can now be cooled directly by means of air convection or water conduction—we no longer have to depend on radiation.

Basically, forced-air and water-cooled tubes are the same in their general construction. The appearance of a basic tube was shown in Fig. 3. A cut-away view of another typical forced-air or water-cooled tube is shown in Fig. 4. In both figures, the filament connections are made at the top of the tube, and both use a multi-strand vertical wire filament. The copper plate or anode is the lower outside shell, and is sealed to the glass envelope as shown in Fig. 4.

The grid is spirally wound around the filament. Its connection in Fig. 3 is the projection at the right; in Fig. 4, the metal ring or "cap" around the top is used as the grid terminal. (The 9C21 tube is designed for grounded grid amplifiers, hence the grid connection is a large "plate" that acts as a shield between the anode and the filament.)

Although some tubes are designed specifically for air cooling only or water cooling only, others are identical except that the air-cooled ones come from the manufacturers mounted in a radiator assembly. In general, the most powerful tubes are water cooled. Water cooling will dissipate between 200 and 700 watts per square inch at anode temperatures between 30 and 70° Centigrade, and corresponding ratings for forced-air-cooled tubes are 3 to 4 watts per square inch at 150 to 200° Centigrade. From this, you can see that

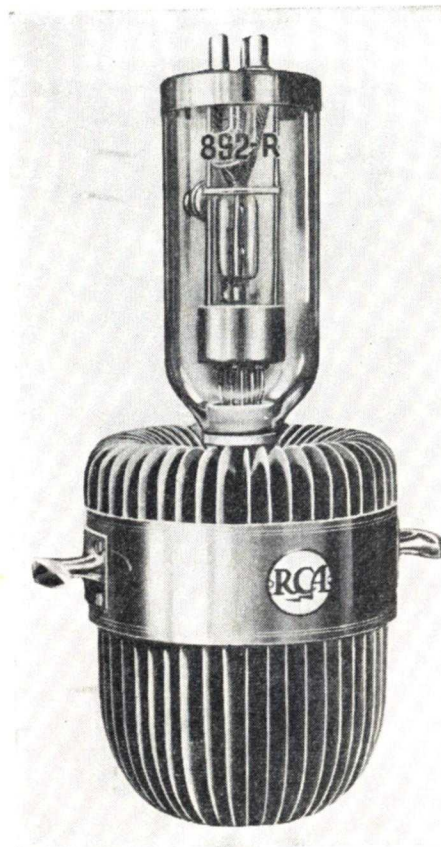

Courtesy RCA

FIG. 5. This is a forced-air cooled tube in its radiator assembly. The letter R in the tube type number distinguishes the one in a radiator. Thus, the 892 is water cooled; the 892R is exactly the same tube in the air radiator. However, the operating voltages are different, because the air-cooling is not as good as water-cooling.

for the same equivalent cooling, an air-cooled assembly would have to be extremely huge in dimensions, or would have to use terrific volumes of air. For this reason, air-cooled tubes are made with the anode connected to a radiator assembly consisting of a large number of very thin fins as in Fig. 5. (A thin coating of heat-conducting solder is used to fasten the anode to the radiator; hence this assembly must be installed at the factory.) In use, air is blown through these fins at high veloc-

ity by a motor-driven blower, mounted below the tube in the transmitter. Either a canvas "sock" or a metal pipe insulated by porcelain blocks can be used to direct the air stream to the radiator. Heated air is drawn away from above the tube by exhaust fans and ducts. Fig. 6 shows another style of air radiator that is being used on high-frequency tubes.

► Fig. 7 shows a cross-sectional view of a typical water-cooling system. By examining the cut-away view of the water jacket, you will see that the water flows around the anode and cools the tube by conduction of heat to the water.

The water is pumped in through a rubber hose or through channels cut



Courtesy General Electric Co.

FIG. 6. This tube is in a different style of air radiator assembly.



in ceramic insulators. These are necessary in order to act as insulators between the high-potential anode and the grounded metal water piping. Where a hose is used, it is normally fifteen or more feet long, so that the water column will act as a sufficient insulator to limit the d.c. current flow (from anode to ground) to a low value.

In order to minimize the r.f. losses, the water hose is wound in the form of a coil, or the grooving in the ceramic blocks is spirally cut, so that the water flows over a spiral (coil-shaped) path. Since the water is at least a poor elec-

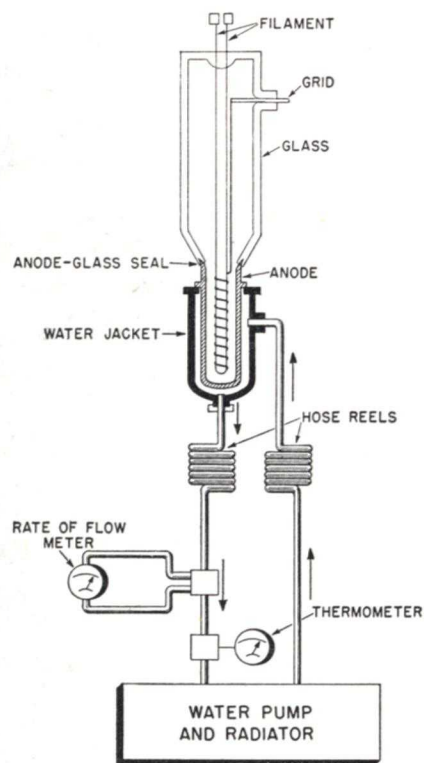
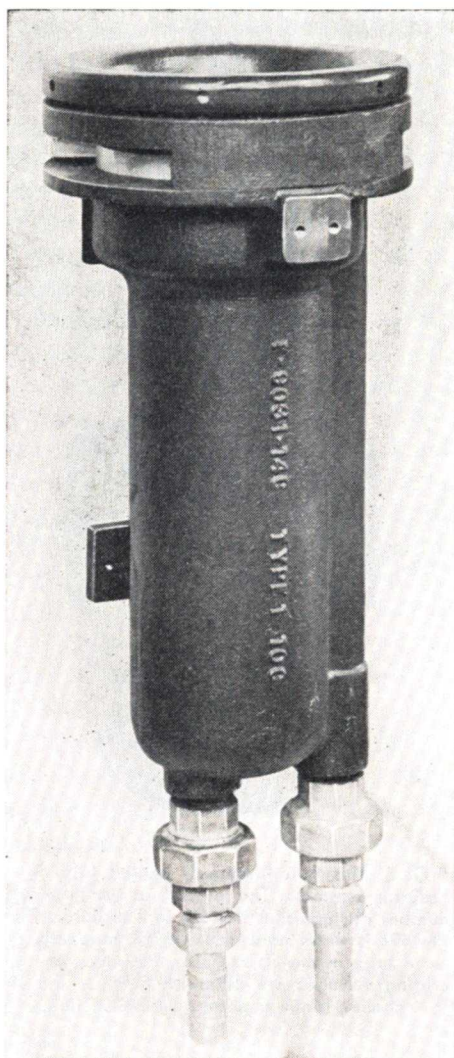

FIG. 7. A typical water-cooling system, with a cut-away view of the water jacket and tube. Water is pumped through the tube jacket. A radiator assembly (outdoors) is used to cool the water. Pure water must be used; most systems re-circulate the same water (stored in a tank) until it becomes fouled and in need of replacing.



Courtesy Federal Telephone and Radio Corp.  
The external appearance of a water jacket into which a water-cooled anode is placed.

trical conductor, it acts like a wire-wound choke. This offers a high impedance to r.f., so the r.f. loss is reduced.

Where a small number of water-cooled tubes is in service, the cooling system may consist of a fan-cooled radiator, a pump and the water jacket interconnected in a closed circulating system. Such a system usually has a

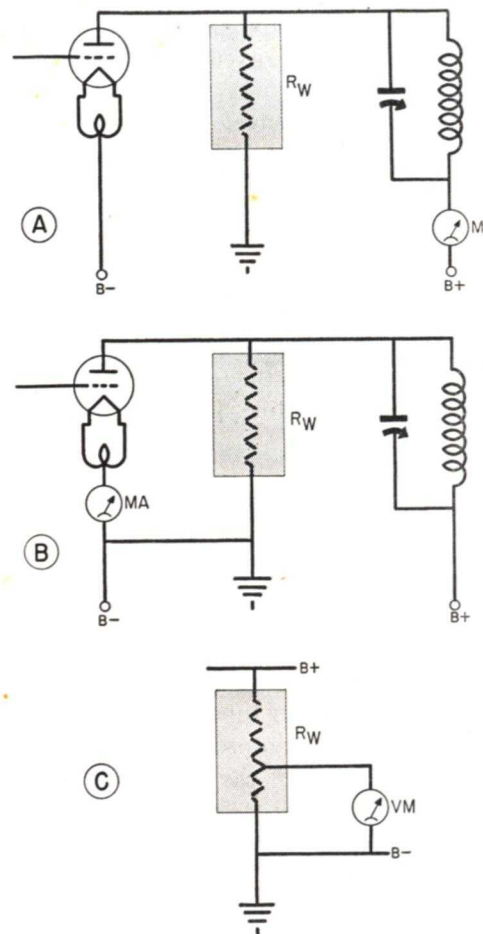

The shaded box marked  $R_W$  represents the water column resistance, which provides a leakage path from plate to ground. At A, the meter MA measures both the plate current of the tube and the current flow through the water column. By moving the meter to the position shown in B, only the plate current of the tube will be measured; the water column leakage is NOT measured here. Incidentally, where it is desired to measure the water column leakage by itself, the connection shown in C is used. The hose is tapped near the grounded end, and a contactor is placed inside it. A voltmeter is connected across this short section of hose. The resistance of the water between these points provides a voltage drop, with the entire water column acting as a voltage divider. By calculation, it is possible to calibrate the voltmeter in terms of leakage current through the water column. Where the voltmeter reading exceeds a pre-determined value, the water in the system is changed, as the leakage is becoming excessive.

water gauge to indicate the height of water in the radiator.

Where a number of water-cooled tubes is employed, the water is usually obtained from a large storage tank, a well, or from water mains, whichever is available. In order to insure an adequate supply, the water is circulated under pressure through an interconnected piping system.

► The cooling water must be kept reasonably pure to minimize power losses and to prevent impurities in it from forming scales on the anode surface, thus forming a heat-insulating layer over the anode. These may cause "hot spots" and destroy the tube.

It is recommended that a supply of water be used having a specific resistance of not less than 4000 ohms. Distilled water or rain water caught in a storage tank is best. Where water is obtained from wells or water mains, it should be analyzed to determine the amount of carbonates, sulphates, etc. contained in it. When the hardness of the water flowing through the cooling system is greater than ten grains per gallon, there is always the possibility of scale formation on the anode of the tubes.

**Tube Protection.** Proper cooling is very necessary, otherwise these tubes would be destroyed almost instantly. The cooling system is placed in operation *before* operating voltages are applied, and must run for a considerable period *after* operating voltages are removed. The exact length of time is specified by the tube manufacturer.

In addition, there must be protection *during* operation. For this reason, transmitters using forced-air or water cooling have interlocking switches, placed so that any failure in the cooling system will instantly



disconnect supply voltages from the tube. In the case of air-cooled tubes, a vane is placed in the air stream. Air pressure holds the vane in a position that keeps a relay closed and permits normal operation. If anything happens to block the flow of air, then the relay will open and will remove all operating voltages. In the case of water cooling, the protection may be either in the form of a flow-meter, or more usually, it is in the form of a thermostatic switch which operates from the water temperature. If the temperature near

the anode gets above the safe level, operating voltages are removed.

In the more powerful water-cooled tubes, the glass envelope and the filament seal need cooling too. The plate may be in a water jacket, and an air stream may flow on the glass envelope to keep it cool.

► Of course, the radiating fin assembly of air-cooled tubes is at the plate potential of the tube. Therefore it must be insulated from the transmitter chassis. In water cooling, the water jacket is insulated.

## Frequency Limitations

Modern practice is to go higher and higher in the frequencies utilized for radio services. This has introduced a

complicating problem in the design and use of transmitting tubes.

As you know, in order for the resonant frequency of the tank circuit to be high, it is necessary to make the inductance and capacity in the tank circuit smaller. We soon get down to where coils consisting of a single turn of wire are too large. At such frequencies, even the leads from inside a big high-power tube will have excessive inductance, and the tube element capacities become comparable to the needed tuning capacity. This is particularly true in the higher powered types, where the elements are quite large.

At ultra-high frequencies, therefore, the tube no longer acts as if its plate-cathode space were a pure resistance. Instead, it has reactive effects. Soon we reach a point where these factors reduce the signal output to an unsatisfactory level.

Transmitting tubes for medium-high frequencies are made more compactly



Courtesy General Electric Co.

FIG. 8. This tube is a compactly designed type developed particularly for operation in the f.m. band—up to 110 megacycles.

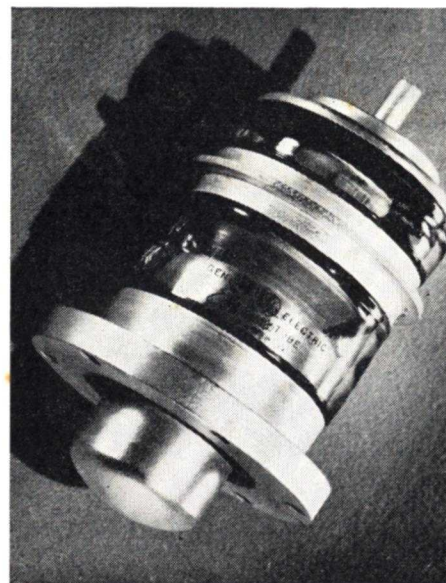

Courtesy General Electric Co.

FIG. 9. The plate is "doubled up" to give adequate cooling in the small space allotted. A drawing of this is shown in Fig. 10.

to cut down on lead lengths. One type is shown in Fig. 8. An even more compact form is shown in Fig. 9 and is sketched in Fig. 10. This tube is "folded" so that the plate, grid and cathode spacings are small.

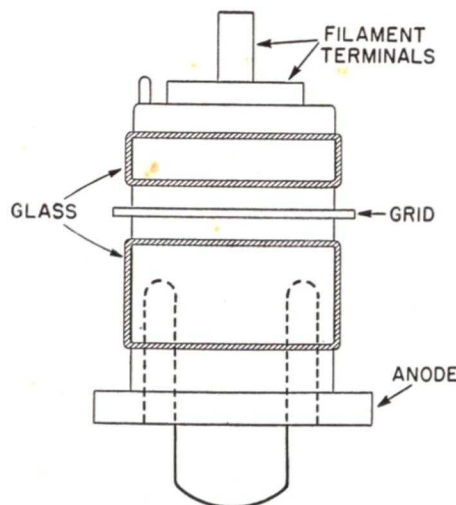
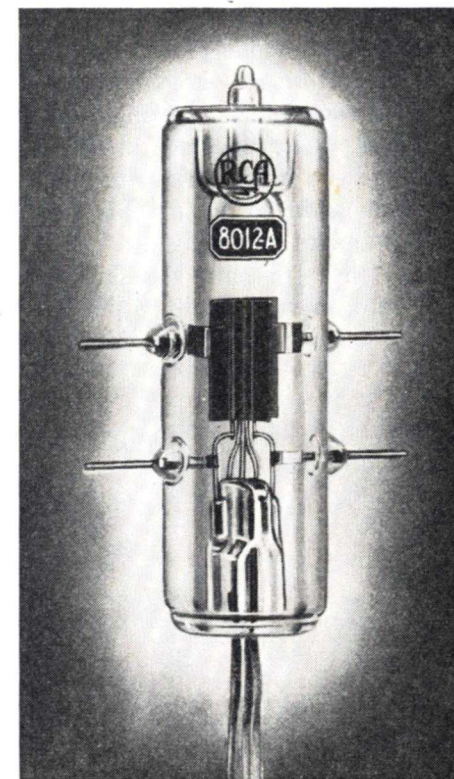

FIG. 10. A drawing of the plate "folding" of the tube in Fig. 9.



Courtesy RCA

FIG. 11. Using dual leads like these provides somewhat less lead inductance.

In an attempt to reduce lead inductances, double leads as in Fig. 11 are used. However, the use of connecting "plates" or rings, as in Figs. 9 and 10 is better, because this has the effect of many leads in parallel, if the proper tank circuit is used.

► Another important limitation is the transit time—the time it actually takes electrons to move from the space cloud to the plate of the tube. If the electrons cannot reach the plate before the signal cycle has changed, then they will tend to swarm back and forth between the grid and the plate. Certain special tube types can make use of an action like this, but in the standard tubes, this prevents normal operation



To decrease the transit time, closer spacings and higher plate voltages are required. However, these requirements oppose each other—for higher plate voltages, wider spacings are needed, so there is a definite limit to how far we can go in correcting this trouble with standard tube design.

For these reasons, standard tubes are rated at their full output up to the frequency at which this output

tube structure. Here, instead of having elements concentrically arranged, with the grid around the cathode and the plate around the grid, the elements are disc-shaped. Fig. 12 shows external appearance of several types, and Fig. 13 is a cut-away of the interior of one.

The cathode is a thimble with a flat top. An oxide coating on this flat top is the emitter. Located extremely close to this emitting surface is a per-

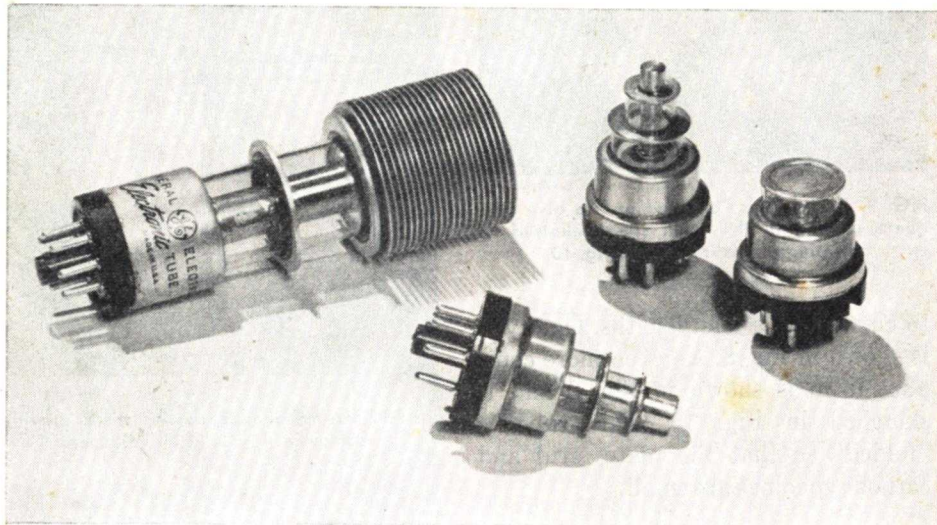

Courtesy General Electric Co.

FIG. 12. Several tubes of the "lighthouse" type. The one with the radiator assembly is a transmitting type.

begins to drop. Beyond this, the percentage of full output for frequencies is given up to the point where the loss in efficiency makes it impractical to use tubes of this particular type.

These problems have caused the development of several radically different tube types for ultra-high frequency use. More about these tubes will be given in later Lessons; here we shall describe them only briefly, to give you an idea of the types that are used.

**Lighthouse Tubes.** One possible answer is the so-called "lighthouse"

forated disc that acts as the grid. The anode surface that is used is the flat end (nearest the grid) of the anode "rod." This construction permits extremely close spacing of elements. However, the very small electrode areas keeps the interelectrode capacity down, despite the close spacing.

Then, instead of having highly inductive wires leading from these elements to the outside connections, the elements are merely continued to the outside in the form of discs. This is the same as having many wires in

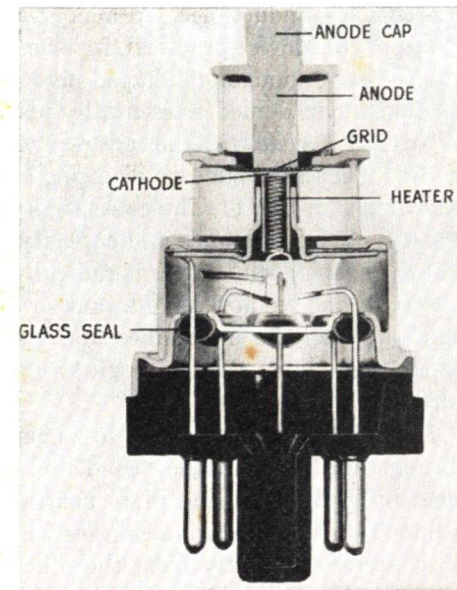

Courtesy General Electric Co.

FIG. 13. A cut-away of a lighthouse tube.

parallel, so contact is made between the special tank circuits and the tube at these points, with the result that there is very little inductance between the elements and the tank circuit. You will learn more about these tubes and their accompanying resonant circuits in a later Lesson.

**The Klystron.** Although different in construction, the lighthouse tube as-

sembly is at least a standard tube in its operation—it is still a triode tube. However, as we go even higher in frequencies, then completely different tube types are utilized. In one type, known as the klystron tube, electrons flow from an emitter through a cavity having a double grid structure. By placing differences in voltage on the two grids, the electrons can be bunched up. They are then allowed to flow from this bunching cavity to another cavity, popularly called the "catcher." Here, the electron bunches cause a difference in potential between two "grids," and therefore this cavity is excited into operation. The frequencies produced in tubes of this kind depend upon the resonant frequency of these cavities.

You may be interested in the type of resonant tank circuit required for such high frequencies. At micro-wave frequencies, the familiar coil and condenser no longer exist in their original form. To see how this comes about, consider a one-turn inductance and a flat-plate condenser as shown in A of Fig. 14. (The condenser plates have holes cut in them to reduce the capacity even further.) The L-C values for this tank resonant circuit fix the resonant

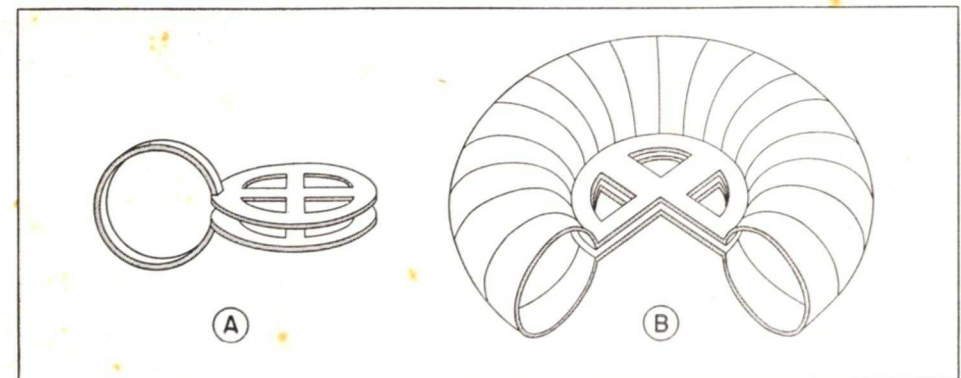

Courtesy Sperry Gyroscope Co.

FIG. 14. How a toroid capacity resonator is developed.





Courtesy Raytheon

A typical cavity type magnetron.

less and less inductance. To make the shape of this device practical, we eventually get a doughnut shaped figure (toroid). This device is essentially just a "cavity"—a can with the ends pushed in to form the condenser element, as shown in B of Fig. 14. Thus, essentially we still have inductance and capacity, but the shape of the device is radically different, and we now have a tank circuit in which the inductance and the capacity are lumped into a single structure.

By allowing electrons to pour through the holes in the "condenser" element in bunches, the plate nearest a bunch of these negative charges will be charged differently from the other plate, hence, energy is supplied to the condenser and thence to the tank.

► There are several other special tube types and circuits that are used at ultra-high frequencies. For instance, the magnetron is a tube that uses a strong magnetic field to cause the electrons to move over circular paths in such a way that resonant cavities are excited. This tube is capable of giving extremely high peak powers for short time intervals, so it is particularly useful for pulse services. You will learn more about these tubes and circuits in later Lessons when you study microwave equipment.

frequency. To increase the resonant frequency further, C or L, or both, must be made smaller. There is a physical limit to the minimum capacitance that can be obtained, and beyond that we cannot decrease C satisfactorily. However, L can be decreased by adding turns in parallel. (As you know, when coils are in parallel, the inductance is less than the smallest.) Therefore, by adding other single turns in parallel with the original turns, we get

## Transmitting Tube Charts

### TRANSMITTING TUBE DATA

Most transmitting tube handbooks and tube charts give rather complete information on each tube type. In general, this information may be roughly divided into four sections.

► The first section contains general information about the particular tube—things like filament voltage and filament current, internal tube capacities, amplification factor or mutual conductance, general information on the cooling methods used and perhaps a short, simple description of the tube type.

► The second section is the one referred to most often. It contains complete operating voltage and current data. In most cases, this section will be divided into classes of service—for example, the tube as a class B audio amplifier, or as an oscillator or a modulated amplifier. Under each of these classes, you will find *maximum* tube ratings given, which is then followed by several sets of typical operating values. A variation of this section is the type that lists tubes for continuous commercial service and for intermittent continuous service, which we will describe in full later in this Lesson.

► A third section of a tube data sheet usually contains information about the basing arrangement and gives an outline drawing of the tube.

► Finally, in the fourth section, there are usually several families of curves, so that complete operating conditions may be determined. Now let's learn something more about each of these sections.

You are already aware of the tube manuals that are available for receiving type tubes. Information on transmitting tubes is given out in the same way — tube manufacturers furnish manuals for transmitting tubes similar to those on receiving tubes, and in general, also furnish data sheets on specific tube types.

As a communications man, you will turn to these tube charts whenever you want to learn the characteristics of tubes with which you are not familiar. In addition, of course, these tube charts are designed to furnish information to the engineer or amateur interested in transmitter construction.

In addition to giving complete characteristics of the tubes covered by the chart, most tube handbooks have rather large sections at the beginning and end that are of interest. There is usually a "circuits" section which shows typical transmitting circuits and gives information on the characteristics of tubes and parts needed for use in such circuits.

Rather full comparison charts are usually given, comparing tubes according to their power output for different service classes. Then too, there will usually be charts comparing tubes and their frequency characteristics—their ability to deliver full rated output at different frequencies. These charts are of particular interest to the design engineer.

Most of this preliminary material is self-explanatory—you won't have any trouble understanding it when you have tube handbooks before you. Therefore, let's turn to the information given on tubes in such charts.

Section 1. Fig. 15 shows typical



9C21		9C22	
<b>TRANSMITTING TRIODE</b> WATER & FORCED-AIR COOLED			
Filament	Tungsten, Multistrand		
Excitation	Single-Phase or D.C.		
Voltage	19.5	a-c or d-c volts	
Current	415	amp.	
(See FILAMENT CONNECTIONS under this type)			
Starting Current - The filament current must never exceed, even momentarily, a value of 750 amperes.			
Amplification Factor	38		
Direct Interelectrode Capacitances (Approx.):			
Grid to Plate	48	μf	
Grid to Filament	95	μf	
Plate to Filament	1.8	μf	
Maximum Overall Length	24-1/2"		
Maximum Diameter	9-1/2"		
Terminal Connections	Special		
(See OUTLINE and FILAMENT CONNECTIONS)			
Water Jacket	UT-4347		
Gasket	RCA Stock No. 43244		
Outlet Water Temperature	70 max. °C		
Water flow of 15 to 20 gallons per minute must start before the application of any voltages and continue for at least 2 minutes after the removal of all voltages. Temperature of the water at the outlet must never exceed the value shown above.			
Filament Seal Temperature	150 max. °C		
Air flow of 10 cubic feet per minute directed into the filament header before and during the application of any voltages is required to limit the temperature of the filament seals to the maximum value.			
Bulb Temperature	180 max. °C		
A stream of air must be delivered at the anode seal and bulb by a suitable duct to limit the bulb temperature to the maximum value at the hottest point.			
Maximum Ratings Are Absolute Values			
<b>MAXIMUM CCS RATINGS AND TYPICAL OPERATING CONDITIONS</b>			
CCS = Continuous Commercial Service			
A-F POWER AMPLIFIER & MODULATOR - Class B			
D-C Plate Voltage	15000 max. volts		
Max.-Signal D-C Plate Current*	6 max. amp.		
Max.-Signal Plate Input*	90 max. kw		
Plate Dissipation*	40 max. kw		
Typical Operation:			
(Unless otherwise specified, values are for two tubes)			
D-C Plate Voltage	10200	14000	volts
D-C Grid Voltage	-220	-300	volts
Peak A-F Grid-to-Grid Volt.	850	1050	volts
Zero-Signal D-C Plate Cur.	0.6	0.6	amp.
Max.-Signal D-C Plate Cur.	5.7	7.1	amp.
Load Resistance (per tube)	900	1000	ohms
Effective Load Resistance (plate to plate)	3600	4000	ohms
Max.-Signal Driving Power#	110	150 approx.	watts
Max.-Signal Power Output	36	61 approx.	kw
* Averaged over any audio-frequency cycle of sine-wave form.			
# The driving stage should have good regulation and should be capable of supplying considerably more than the required driving power.			
Dec. 1, 1943			
RCA VICTOR DIVISION TENTATIVE DATA 1 RADIO CORPORATION OF AMERICA, HARRISON, NEW JERSEY			

FIG. 15. Two pages taken from the RCA tube handbook, showing how general data is usually listed.

examples of the first section, taken from a tube handbook. The description of the tube as a pentode, a triode, or another general type is something you already know about. Also, the interelectrode capacity values are similar to those of receiving tubes, except that they are, of course, larger.

In the same way, the filament voltage and current ratings are obvious. Naturally, you can expect values that are higher than those of receiving tubes. Transmitting tube filament voltages range from the receiving-tube values up to about 33 volts. Filament currents, on the other hand, run up to

rather astounding levels—some of the most powerful transmitting tubes draw filament currents of 200 to over 400 amperes!

Many of the more powerful tubes have multiple filaments, as was shown in Fig. 4. In some instances, these strands all connect to the same two terminals, so only a single pair of connections are made. In other instances, however, the filaments are entirely separate units, and the tube may have four or six filament terminals. The proper pairs can be connected together so that all these elements are in parallel for d.c. or single-cycle a.c. opera-

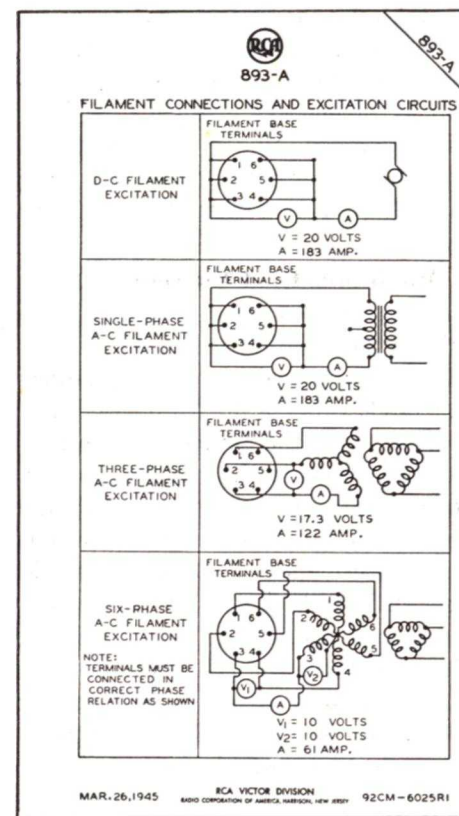

FIG. 16. How RCA gives filament connection data.

tion, or in the case of a triple filament, a three-phase power supply may be used, as in Fig. 16.

The section on cooling gives information as to the air volume or water flow needed, the temperature limits, and usually data on the length of time the coolant should flow before and after normal operation. The latter is particularly important information for the operator.

### MEANING OF MAXIMUM RATINGS

The second section of transmitting tube charts gives several "maximum" ratings. These maximums are the values, set by the tube manufacturer, that

will give good performance with longest tube life. Maximum ratings therefore do not represent the full capabilities of the tube in all instances. It is possible to exceed these maximums under special circumstances, but if you do, the tube life will be shortened. Transmitting tubes cost large sums of money, so long life is important.

Among the values usually given for amplifier tubes are those for maximum plate voltage, maximum plate current, maximum plate dissipation, and sometimes, maximum grid current. (Rectifier tubes are covered in another section of this Lesson.) Briefly, the fol-



Courtesy, Columbia Broadcasting Co.

Tubes must be quickly replaced when defective. Hence, the connections are easy to make. Here, a filament harness is being placed on a high-power tube. The harness assembly clamps to the tube connecting prongs.

lowing will apply to these maximum ratings:

**Maximum Plate Voltage.** In the smaller transmitting tubes on which all leads come out through the base, there is a definite limit on the maximum plate voltage that can be applied without spark-over. However, most transmitting tubes are of the double-



ended type with the plate lead coming out the top, or are the forced-air or water-cooled types in which the grid and filament terminals are well separated from the plate. With these, and with good insulation and high vacuum, the maximum plate voltage is no longer limited by voltage breakdown, but by considerations of filament emission, damage to the glass bulb caused by dielectric losses, and tube life. The plate voltage, as well as grid bias, determine the peak current that is drawn from the cathode, and if the maximum plate voltage rating is exceeded, shortening of the tube life will result. The maximum plate voltage should not be exceeded, regardless of other conditions, at any time.

**Maximum Plate Current.** The fundamental limitation on plate current is, of course, the total emission available from the filament. The maximum figure is intended to be a value which may be easily obtained throughout the life of the tube. It is recommended that the maximum plate current should not be exceeded during the life of the tube, particularly in those tubes having thoriated or oxide-coated cathodes.

**Maximum Plate Dissipation.** The maximum plate dissipation of a tube is that number of watts which the plate can safely dissipate as heat, and is limited by the plate temperature and its effects on parts of the tube other than the plate. The plate will withstand several times the maximum dissipation values, but the heat generated by operating the tube above the maximum dissipation value has a considerable effect on other parts of the tube. The radiant heat from the plate heats the grid, the filament, and the bulb, while the heat conducted away from

the plate by the plate lead contributes to the heating of the plate seal. These effects are not instantaneous, however, and so momentary overloads may not cause damage. Under continuous operation, however, the maximum plate dissipation rating should not be exceeded.

**Maximum Grid Current.** In the average transmitting tube structure the grid surrounds the cathode, and it in turn is surrounded by the anode. Since the anode gets hot during operation of the tube, and the cathode is also at a high temperature, the grid gets hot too. It is important, therefore, to keep the grid temperature below the value that would cause undue heating. If the grid gets sufficiently hot to emit electrons (primary emission), the departing electrons leave the grid more positive (i.e., grid bias changes) and so the grid attracts more cathode electrons. These bombarding electrons heat the grid further, and also cause secondary emission. Very soon the increased positive grid causes the plate current to reach abnormally high values and may destroy the tube. In the case of oxide-coated cathode tubes, some of the oxide may evaporate onto the grid, and then as the grid heats, it acts as a secondary cathode. Also the grid may be heated sufficiently to result in deformation or melting. It thus becomes necessary to limit the permissible grid dissipation.

When the maximum grid-current value is given, the maximum grid dissipation is implied thereby. This is so, for in general, it would not be likely that the tube would be used in a circuit employing more grid bias than necessary, since this would result in an increase in driving power without other compensating advantages.

## TRANSMITTING TUBE TYPE F-207

### 10 Kilowatts Plate Dissipation

#### Maximum Ratings and Typical Operation Data For maximum frequency of 1.6 megacycles

CLASS B A-F POWER AMPLIFIER AND MODULATOR		CLASS C TELEPHONY PLATE-MODULATED R-F POWER AMPLIFIER <small>(Carrier conditions per tube for use with a maximum modulation factor of 1.0)</small>	
<b>Maximum Ratings</b>		<b>Maximum Ratings</b>	
DC Plate Voltage	15,000 volts	DC Plate Voltage	10,000 volts
Max. Signal DC Plate Current*	2.0 amperes	DC Grid Voltage	-3,000 volts
Max. Signal Plate Input*	20 kw	DC Plate Current	1.0 amperes
Plate Dissipation*	7.5 kw	DC Grid Current	0.2 amperes
		R-F Grid Current	24 amperes
		Plate Input	10 kw
		Plate Dissipation	6.6 kw
<b>Typical Operation</b> <small>(Unless otherwise specified, values are for 2 tubes)</small>		<b>Typical Operation</b>	
DC Plate Voltage	12,500 volts	DC Plate Voltage	10,000 volts
DC Grid Voltage	-575 volts	DC Grid Voltage	-2,000 volts
Peak A-F Grid-to-Grid Voltage	2,300 volts	Peak R-F Grid Voltage	2,660 volts
Zero Signal DC Plate Current	0.4 amperes	DC Plate Current	0.75 amperes
Max. Signal DC Plate Current	2.8 amperes	DC Grid Current	0.07 amperes (approx.)
Load Resistance (per tube)	2,500 ohms	Driving Power	185 watts (approx.)
Effective Load Resistance (plate to plate)	10,000 ohms	Power Output	6 kw (approx.)
Max. Signal Driving Power	400 watts (approx.)		
Max. Signal Power Output	22.5 kw (approx.)		
*Averaged over any audio-frequency cycle.			
<b>CLASS B TELEPHONY R-F POWER AMPLIFIER</b> <small>(Carrier conditions per tube for use with a maximum modulation factor of 1.0)</small>		<b>CLASS C TELEGRAPHY R-F POWER AMPLIFIER AND OSCILLATOR</b> <small>(Key-down conditions per tube without modulation)†</small>	
<b>Maximum Ratings</b>		<b>Maximum Ratings</b>	
DC Plate Voltage	15,000 volts	DC Plate Voltage	15,000 volts
DC Plate Current	1.0 amperes	DC Grid Voltage	-3,000 volts
R-F Grid Current	24 amperes	DC Plate Current	2.0 amperes
Plate Input	15 kw	DC Grid Current	0.2 amperes
Plate Dissipation	10 kw	R-F Grid Current	30 amperes
		Plate Input	30 kw
		Plate Dissipation	10 kw
<b>Typical Operation</b>		<b>Typical Operation</b>	
DC Plate Voltage	14,000 volts	DC Plate Voltage	12,000 volts
DC Grid Voltage	-650 volts	DC Grid Voltage	-1,600 volts
Peak R-F Grid Voltage	730 volts	Peak R-F Grid Voltage	2,650 volts
DC Plate Current	1.0 amperes	DC Plate Current	1.67 amperes
Driving Power**	0 watts (approx.)	DC Grid Current	0.09 amperes (approx.)
Power Output	4 kw (approx.)	Driving Power	235 watts (approx.)
		Power Output	15 kw (approx.)
**At crest of a-f cycle with modulation factor of 1.0		†Modulation essentially negative may be used if the positive peak of the audio-frequency envelope does not exceed 115% of the carrier conditions.	

Courtesy Federal Telephone and Radio Corp.

FIG. 17. This chart gives operating potentials for four classes of operation for the Federal F-207 tube.

### AVERAGE OPERATING VALUES

Usually, the maximum ratings are grouped with one or more sets of typical operating values in a listing for a particular class and type of service, as in Fig. 17. Here, the tube manual differs rather widely from the receiving tube manuals in that a number of con-

ditions must be covered. A transmitting tube may be used in class A, class B, or class C stages. Furthermore, these stages may differ in their requirements—those for an oscillator stage may be different from those for a modulator or an amplifier stage. Furthermore, the ratings are different according to



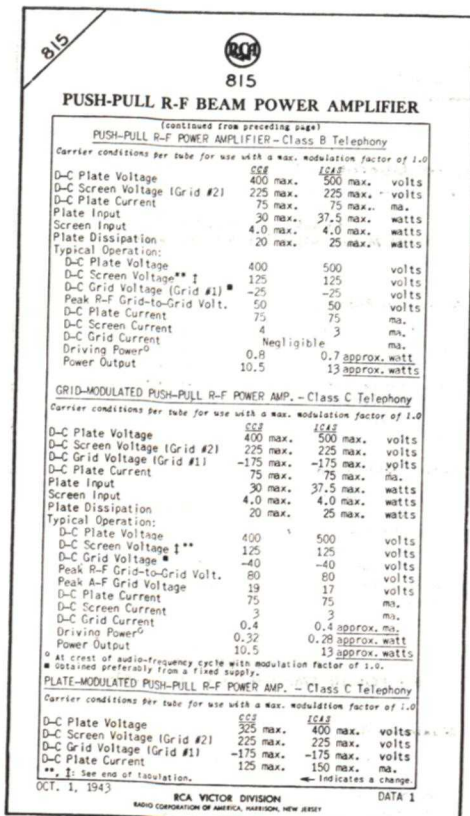

the tube is a type designed specifically for these services.

Other charts sub-divide the values further by having a pair of listings—one the CCS (continuous commercial service) rating, and the other the ICAS (intermittent commercial and amateur services) rating. The latter ratings are higher because the tube is not continuously in use in the intermittent commercial service, and amateurs usually drive their tubes harder. In other words, the ICAS rating may result in somewhat reduced tube life, but higher power outputs are obtainable. In applications where minimum size and weight with maximum power output are more important factors than extremely long tube life, a small tube operated under ICAS ratings may better meet requirements than a larger tube operated under CCS ratings. Fig. 18 gives an example of this form of listing.

▶ Another listing you may encounter is "IMS"—intermittent mobile service. This is an extension of the ICAS rating for such services as aircraft where light weight and extremely small size are far more important, and where the "ON" periods are exceedingly short. In fact, this rating is given for operation with a maximum "ON" period of 15 seconds, followed by an "OFF" period of at least 60 seconds. Even so, this operation results in far shorter tube life.

**Sections 3 and 4.** Figs. 19 and 20 are typical of the outline drawings and characteristic curves that are the third and fourth sections of the usual tube chart.

FIG. 18. This RCA chart gives CCS and ICAS ratings.

whether the tube is continuously used or intermittently used. In radiotelephony, the tube is subject to continuous operation. On the other hand, in radiotelegraphy, the tube may be used only during the moments when the key is down. Under such operation, it is possible to drive a tube somewhat harder than under the conditions of continuous operation, because current flows for smaller periods of time. Other intermittent services such as pulse modulation must also be covered where

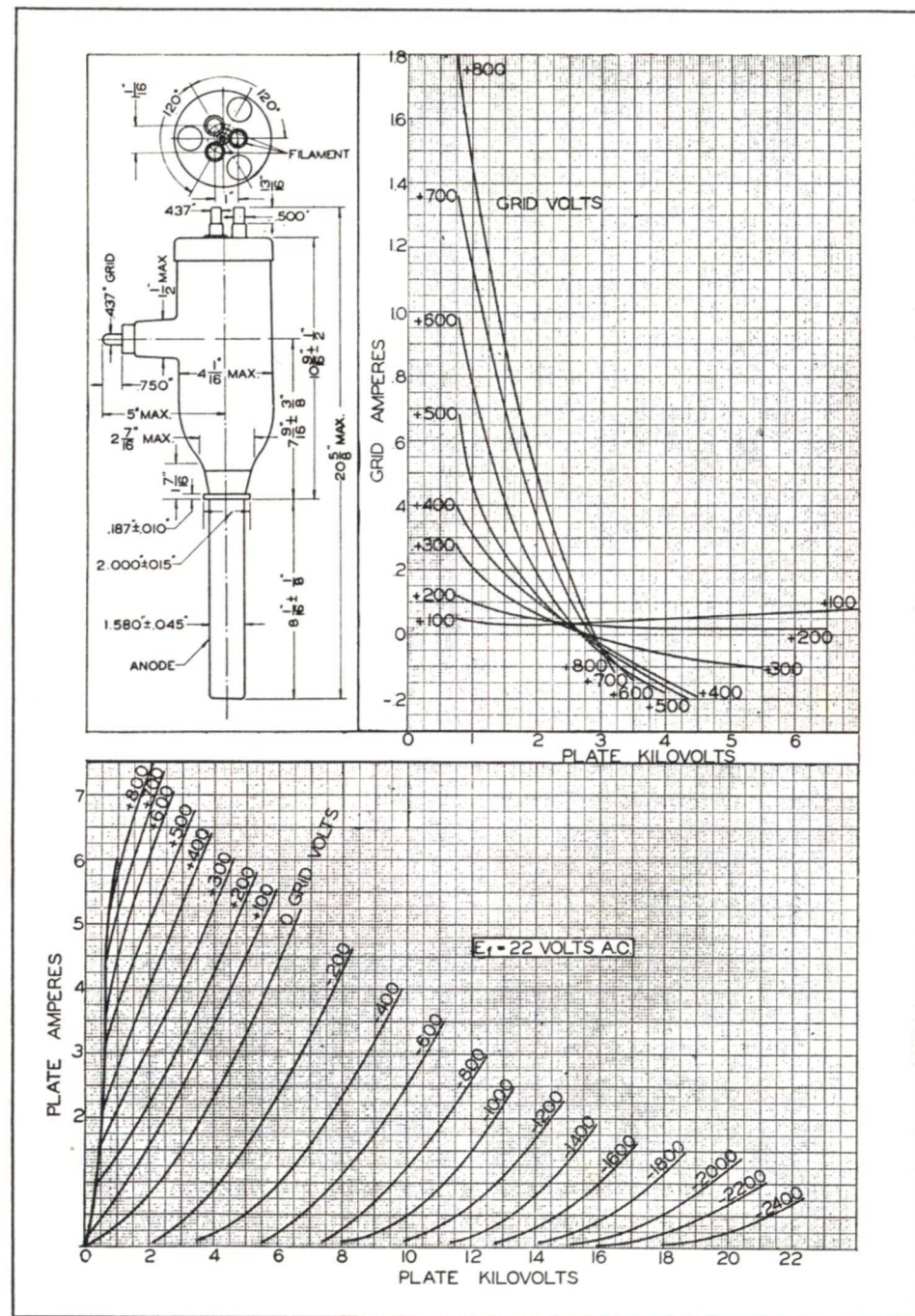

FIG. 19. This Amperex chart is typical of the tube outline dimensions and characteristic curves that you will find in tube manuals.



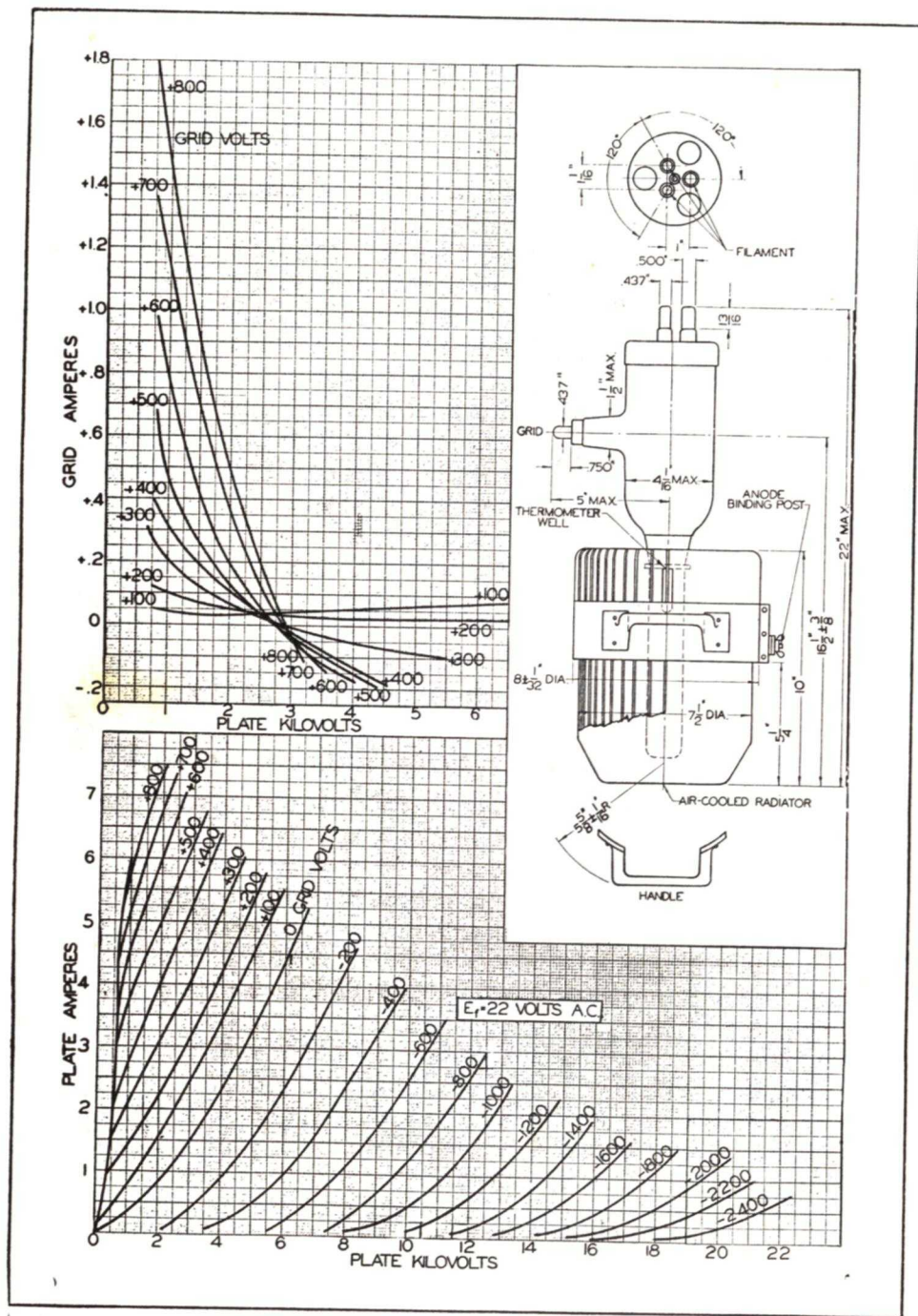

FIG. 20. The data on this air-cooled tube is the same as that of its water-cooled counterpart in Fig. 19, except for the tube outline dimensions.

Courtesy Ampere Electronic Corp.

## Definitions for Rectifier Tubes

The characteristics of transmitting rectifier tubes are listed in tube tables in a manner similar to that for amplifying tubes. However, there are different meanings that should be placed on the maximum ratings. In the following, we will first cover vacuum types, then the mercury vapor rectifiers.

### VACUUM RECTIFIER TUBES

#### Maximum Peak Inverse Voltage.

This is the highest peak voltage that a rectifier can safely withstand in the opposite direction to that in which it is designed to pass current. This is illustrated in Fig. 21, in which the two tubes are in a full-wave rectifier circuit. At a given instant, assume point A to be + and point B to be -. Tube  $VT_1$  will then conduct since its plate is positive with respect to its cathode. When  $VT_1$  is conducting, the voltage appearing across  $VT_2$  is the *total secondary* voltage of the transformer minus the small drop in  $VT_1$ , which can usually be neglected. (Trace the circuit from point A through  $VT_1$  to the cathode of  $VT_2$ .) Since the polarity of the voltage across  $VT_2$  is reversed, it cannot conduct. However, this peak inverse-voltage which tube  $VT_2$  must stand is the r.m.s. voltage between A and B, times 1.4. If tube  $VT_2$  cannot withstand this inverse voltage, it will break down and cause an arc-back which may be severe enough to destroy the tube.

#### Maximum Peak Anode Current.

This is the highest peak current that a rectifier can safely stand. The safe value of this peak current in hot-cathode types of rectifier tubes depends upon the available electron emission

and the duration of the flow from the rectifier tube during each half cycle. In a given circuit, the value of peak plate current is largely determined by the filter constants. If a large choke is used in the filter circuit next to the rectifier tubes, the peak plate current is not much greater than the load current. However, if a large condenser is used in the filter next to the rectifier tubes, the peak current is often many times the load current. In order to measure

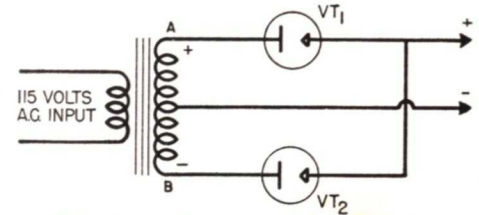

FIG. 21. A full-wave rectifier connection.

the peak current in any circuit, a peak indicating meter or an oscilloscope is recommended.

### GAS RECTIFIERS

This type of rectifier tube contains a gas at low pressure (about 1/100,000 to 4/100,000 of normal atmospheric pressure). Among the gases used are mercury vapor in equilibrium with liquid mercury (types 866A, 872A, 869A), and gases such as hydrogen, krypton, xenon, argon, and neon (types 3C45, 3B25). In mercury vapor rectifiers such as the one in Fig. 22, only a small quantity of mercury, usually not more than a few drops, is sufficient to supply ample vapor.

The gases usually employed have ionization potentials below 20 volts (10.4 volts for mercury, 12.6 volts for



hydrogen, for example) and this means that when a potential difference of 10.4 volts is applied between the plate (positive) and the cathode (negative) of a mercury-vapor rectifier, some of the electrons flowing from the cathode

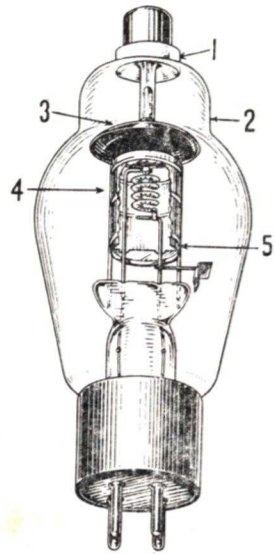

FIG. 22. A cut-away of an RCA 866A mercury vapor rectifier. (1) Ceramic Insulator to minimize corona discharge, (2) dome bulb and (3) low-hanging anode to minimize ionization in upper section of bulb, (4) edgewise wound filament for great emission, (5) shielded filament construction.

to the plate will collide with the mercury-vapor molecules and knock electrons out of them (ionize them). When the plate voltage is increased to 15 volts positive, these ionizations become relatively numerous.

The electrons thus produced are attracted to the plate, where they add to the normal flow of electrons from the cathode. In addition, the positive mercury vapor ions (which result from mercury molecules losing electrons) are attracted toward the filament. When these positive mercury ions reach the space charge region, they combine with electrons in the space

charge, which neutralizes the normal negative space charge caused by the filament electrons, with the result that the space charge becomes practically zero. Thus the entire electron emission from the filament can flow to the plate even though a positive plate voltage of only 15 to 20 volts is applied. Hence, the plate current reaches its full maximum at a plate voltage just above that giving full ionization. Fig. 23 shows how the plate current varies when mercury vapor is present in a rectifier tube.

Because of its low, practically constant voltage drop, the gas rectifier is more efficient and provides better voltage regulation than the vacuum-tube rectifier. However, because of the additional positive ions in the tube, it is inherently much noisier than the vacuum-tube rectifier. From the above discussion it can be seen that for a tube of given size and given filament power, the mercury vapor rectifier will pass a higher current than the vacuum-tube rectifier.

The gas rectifiers are rated in terms of the same operating factors as the vacuum tube rectifier; namely, maximum peak inverse voltage, peak forward voltage, peak plate current, and safe average plate current. The peak inverse voltage is limited by the voltage which will cause sparking across the low pressure gas vapor, and therefore is lower than for a vacuum tube rectifier of the same general dimensions.

#### Maximum Peak Forward Voltage

This is the highest peak voltage that the tube can safely withstand in the direction in which it is designed to pass current. If this voltage is exceeded the tube may arc internally, and the very heavy current drawn during the arc, as well as heavy back-bombardment of

the cathode by positive ions, will cause the cathode coating to be stripped, and thus ruin the tube.

#### Maximum Average Plate Current.

The highest value of average current that should be allowed to flow through the tube is limited by the plate-cathode resistance of the tube, for the tube voltage drop (average plate current times plate-cathode resistance) must never exceed about 22 volts in the case of hot cathode mercury-vapor recti-

► In addition to the average value, the *maximum* peak current value should not be exceeded. Sudden surges which cause abnormally high peak currents to flow will cause damage to the filament by back bombardment of the gaseous positive ions, resulting in shorter tube life. The surges that come from overloads cannot be computed accurately, but the most probable cause of trouble if the tube is being operated too near its maximum peak

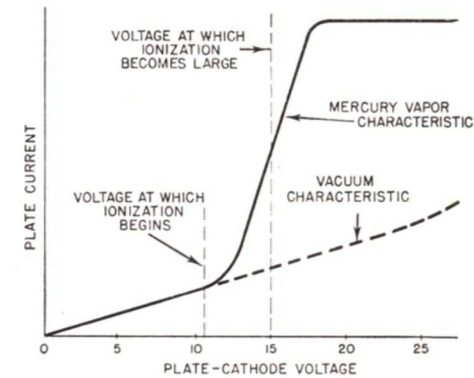

FIG. 23. The voltage-current characteristics of a mercury vapor rectifier.

fiers. As the tube voltage drop increases, the speed with which the mercury-vapor positive ions hit the cathode increases, and when the voltage exceeds about 22 volts, the bombardment of the cathode by the positive ions becomes injurious, resulting in disintegration of the cathode. Thus, if the average anode current exceeds the maximum average anode current for any length of time, the life of the tube will be shortened.

With a steady load, the average anode current may be read directly on a d.c. meter. With a fluctuating load, the reading should be averaged over a period of time as specified under *Characteristics*, which is listed for each rectifier tube in the tube manuals.

current rating arises from condenser input-power-supply filters. When the condenser input filter is used, the first condenser is recharged with a sudden sharp current pulse which may be many times the steady value of load current.

When a choke input filter is used, the choke tends to smooth out the current pulse, for it tries to hold the current constant, and so the peak rectifier current will be little larger than the steady value. Thus it can be seen that condenser input filters should not be used when the rectifier tubes are operated near their maximum ratings, and for better tube life the choke input filter is to be preferred.

► When a heavy current overload is



thrown on a high-vacuum rectifier, its voltage drop increases, and so in this manner it tends to take care of itself. The constant voltage drop in gas vapor tubes, however, does not change, and so care should be taken that the tubes are not overloaded. This may be accomplished by adding enough plate circuit resistance to limit possible current surges to a safe value.

**Ionization and De-Ionization Time.** The ionization time is the time required for a sufficient number of positive ions to be formed around the cathode to allow the maximum peak current to pass without damaging the cathode. The de-ionization time is the time required, under normal conditions, to clear the space inside the bulb of positive ions. The de-ionization

**Optimum Operating Temperature.** The gas vaporization depends on temperature, so gas-filled tubes are temperature-sensitive. In the lower curve of Fig. 24 it can be seen that the plate-cathode voltage drop varies with the mercury-vapor temperature in such a manner that this voltage drop increases as the temperature decreases. If the vapor temperature becomes so low that the internal voltage drop exceeds a critical value of approximately 22 volts, the mercury ions acquire sufficient velocity to damage the cathode. This situation occurs at a mercury-vapor temperature slightly less than 15°C. This sets the limit represented by the dotted line K-K.

On the other hand, if the mercury-vapor temperature is increased to avoid cathode disintegration, the effect of such increased temperature on the arc-back voltage becomes important. The arc-back is caused by the inverse voltage to which the tube is subjected during the non-conducting portion of the cycle. The upper curve in Fig. 24 shows the relation between mercury-vapor temperature and the arc-back voltage, and it can be seen that as the temperature is increased beyond the maximum allowable temperature point (line L-L), the arc-back voltage decreases very rapidly. Thus the tube will spark over at a lower peak inverse plate voltage if the temperature is raised too high. Hence, operation must be limited to the temperature range between the dotted lines. The tubes must be cooled if they are too hot, or they must actually be heated if in too cold a location.

The curves in Fig. 24 do not give actual values of temperature or voltages, since the curves are intended to apply generally to all sizes of mercury

vapor tubes. The limiting conditions, however, are given in tube charts.

**Other Gas Types.** The major problems in the past for gas tubes other than mercury-vapor types have been: (1) Other gases are gradually absorbed or "cleaned-up" by the tube elements, with consequent shortening of tube life; (2) an inability to reduce the ambient temperature co-efficient so as to make the tube nearly independent of ambient temperature variations; and (3) long de-ionization time as compared with mercury-vapor types.

The few drops of liquid mercury in a mercury-vapor tube act as an infinite reservoir for mercury vapor, whereas there are no such corresponding reservoirs for gases such as hydrogen, helium, neon, argon, krypton and xenon. However, with modern techniques, some gas tubes are now made with gases other than mercury vapor. These newer tubes have long tube life and a lower ambient temperature co-efficient and quicker de-ionization time than that of mercury vapor. The type 3B25 is typical.

## Handling and Conserving Transmitting Tubes

The transmitting tube characteristic data also includes information on mounting and protecting the tubes. In addition, there are certain general rules about filament and other supply voltages that must be carefully observed. When studying data on any particular tube type, be sure to note these limits, so that you can avoid damage to the tube through improper operation.

### INSTALLATION

The data under each tube type contain the required type of socket or mounting for the tube under consideration. In most cases, though not all, the tube is to be operated in a vertical position with the base down. Any special precaution in mounting position will be noted in the tube manual. In applications where the tube is liable to be subjected to vibration or shock, the tube should be mounted in a shock-absorbing mount.

Since nearly all transmitting tubes operate at high plate voltage, the plate connection is well separated from the filament and grid connections in order to minimize leakage between plate and grid, and between plate and cathode. Glass is a very good insulator, but must be kept clean (chemically clean) in order to preserve its best insulating qualities. Since it is inevitable that dirt and moisture will accumulate on the bulb, the insulating properties of the glass will decrease and there will be appreciable leakage across the bulb between terminals. Hence, transmitting tubes are cleaned at regular intervals.

Care should be taken to keep metallic objects such as connecting wires from touching the bulb, otherwise, leakage will be accelerated; this may result in sparking and an arc or flash-over which may crack the bulb. In addition, the resulting local cooling may crack the glass bulb. Hence, all wires and connections should be made

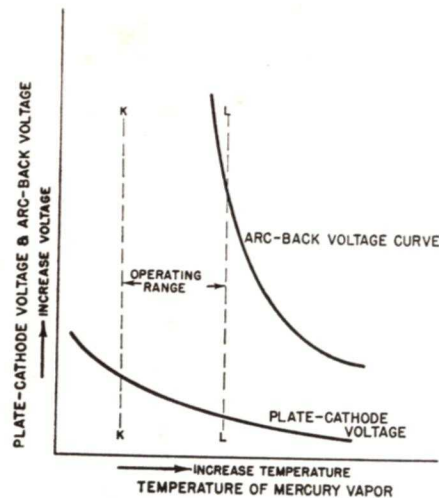

FIG. 24. Temperature and voltage curves for mercury vapor rectifiers.

time, when given, is based on a condition of maximum anode current and fixed bulb temperature. The ionization and de-ionization times limit the frequency at which the gas rectifiers can be operated usefully.



so that they will not touch the bulb, or be too close.

When the transmitting tube has the plate terminal at the top (true of practically all transmitting tubes except forced-air or water-cooled types), flexible leads should be used in making the anode connections to these caps in order to minimize strains placed on the glass bulb at the base of the cap.

An important point is that the anode caps should *not* be used to support coils, condensers, chokes, or other circuit elements, in order to minimize strain and avoid a possible crack at the base of the plate cap. Also, nothing should be soldered to the plate caps, because the heat of the soldering may crack the bulbs.

### NEW TUBES

Transmitting tubes eventually go bad, just as do receiver types. The filament may burn out, the emission may gradually fail, an arc or flash-over may puncture the envelope, etc. Hence, replacement tubes are stocked at most transmitters, so that a new one can be installed in a minimum of time.

In accordance with generally accepted practice, water-cooled tubes should be mounted with the filaments in a vertical position. It is highly desirable, therefore, that tubes be stored in racks which are protected from vibration as well as from moisture and extreme temperature changes. In the case of water-cooled tubes with flexible leads, care should be taken to prevent the filament leads from striking the glass with the resultant possibility of breakage.

From time to time, the stock tubes are placed in the transmitter or in a "test jig," and at least their filaments

are heated for several minutes to keep them in condition and provide a check of them. Then, when a new tube is installed, there is less necessity for a long "baking out" period of operation before plate voltage is applied. Even so, if at all possible, the filament should be lighted a full minute or so before plate voltage is applied.

Installation of water-cooled tubes is fairly simple if accomplished with reasonable care. Spare gaskets are supplied with each tube to obviate the necessity of ever using gaskets other than those supplied with the tube. After the proper gasket is placed on the anode, the tube should be placed in the water jacket very carefully and turned gently to make sure that the flange seats properly in the jacket. The tube should then be secured in the jacket by tightening the clamps just enough to prevent any water leaks; otherwise, the flange may be distorted.

All the moving parts of the water jacket (clamps, etc.) should be kept covered with a film of oil to prevent corrosion and sticking.

After correct adjustment and clamping of the tube in the jacket, the filament and grid leads should be connected in such a way that no strain is placed upon them. These leads should always be disconnected before unclamping the tube and removing it from the water jacket.

► The filament voltage is usually controllable, and it is important that it be set properly. There is usually a filament voltmeter permanently connected across the filament terminals of the larger transmitting tubes to indicate proper adjustment.

The effect of change in filament voltage upon the life and emission of tungsten filaments is shown in Fig. 25,

and it can be seen that a very small change in filament voltage results in a considerable change in filament life.

The graph in Fig. 25 shows theoretical filament life data based on normal evaporation of tungsten filaments. This possibility of increasing tube life by reducing filament voltage, and consequently filament temperature, results from the fact that bright tungsten filaments may be operated at complete saturation. This means that peak currents amounting in value to the total available emission may be drawn continuously without damage to the filaments, even when the emission is reduced by operation at a lower filament voltage.

On the other hand, operating a *thoriated* tungsten filament at lower temperatures does not increase its life. In fact, quite the opposite. This is so because during operation of the tube, the thorium in this layer is constantly being removed by evaporation and bombardment, and is constantly being replenished from within the wire. In order to maintain the balance between the loss and replacement of an active layer of thorium, the filament must be operated within a narrow range of temperatures, and unusually short life may result from operation of a thoriated tungsten filament at values much above or below the rated value. Thus it is essential that the filament voltage be maintained at all times within the specified limits listed in the tube ratings.

### PRECAUTIONS FOR GAS-FILLED RECTIFIERS

There are several precautions to be observed in installing and operating gas-filled rectifiers. Briefly, these are:

(a) It is important to turn the filament on first in hot-cathode gas rectifiers in order to allow it to heat up for a few minutes before closing the plate circuit. This is done in order to prevent bombardment of the cathode by the positive vapor ions. A time-delay relay in series with the plate circuit is usually used for taking care of this auto-

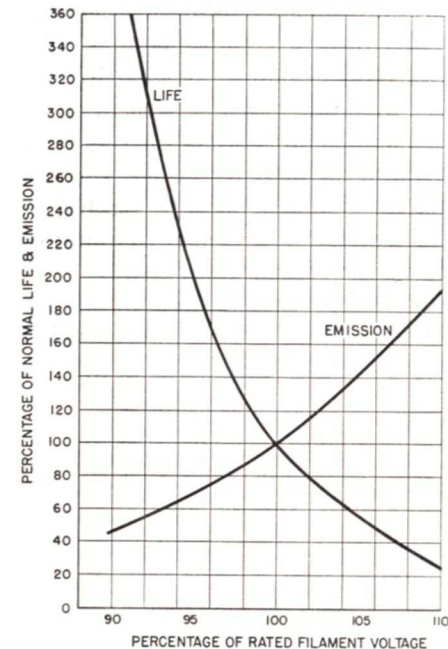

Courtesy Federal Telephone and Radio Corp.

FIG. 25. Effect of change in filament voltage upon the life and emission of tungsten filaments.

matically. The brief warming up period allows the bulb to reach its normal operating temperature, and insures correct vapor pressure when plate voltage is applied.

(b) The maximum allowable tube ratings should never be exceeded, even momentarily. Exceeding the ratings may increase the tube voltage drop to a value greater than the allowable maximum (22 volts for mercury-vapor tubes); if this were to happen, positive ion bombardment would produce disin-



tegration of the cathode.

(c) A gas-vapor tube should always be mounted in a vertical position with the filament connections down. In this position there will be no filament sag, and in the case of mercury-vapor tubes, no metallic mercury will be deposited on the active elements of the tube.

(d) When mercury-vapor tubes are first unpackaged, it may be noticed that shipment handling has caused mercury deposits to collect on tube parts. This condition materially reduces the ability of the tube to withstand high plate voltage. In order to distribute the mercury properly in the tube, the filament must be lighted at rated voltage for about 15 minutes before plate voltage is applied.

(e) Before installation, clean the bulb to prevent leakage effects which

may cause the bulb to crack and break.

(f) During use, keep the tube within specified temperature limits, especially mercury-vapor rectifier tubes.

(g) Gas tubes which are used to furnish power to r.f. transmitters should be shielded from the r.f. field. This field causes ionization of the gas. Ionization of the gas vapor this way can cause injurious effects to the cathode, and reduces the value of the peak inverse voltage that the tube will withstand.

(h) Since gas rectifier tubes get hot during operation, they should not be mounted so that the glass bulb is in contact with metal, and care should be taken not to spray or to drop liquids on the glass bulb. This localized cooling of the glass may develop strains which will ultimately crack the bulb and ruin the tube.

## Lesson Questions

Be sure to number your Answer Sheet 30RC.

Place your Student Number on every Answer Sheet.

Most students want to know their grade as soon as possible, so they mail their set of answers immediately. Others, knowing they will finish the next Lesson within a few days, send in two sets of answers at a time. Either practice is acceptable to us. However, don't hold your answers too long; you may lose them. Don't hold answers to send in more than two sets at a time or you may run out of Lessons before new ones can reach you.

1. Which of the following vacuum tube emitters may be reactivated: 1, *pure tungsten*; 2, *oxide-coated*; or 3, *thoriated tungsten*?
2. When used as the anode of a transmitting tube, which one of the following materials does not glow red to a sufficient degree to permit the operating conditions to be judged by its color: 1, *molybdenum*; 2, *carbon*; 3, *tungsten*; 4, *nickel*?
3. What is the reason for winding the hose connectors for water-cooled tubes in a spiral form—like a coil?
4. Why is it necessary to use reasonably pure water in the cooling system of water-cooled tubes?
5. What is the purpose of the relay-vane assembly that is placed in the air stream of forced-air-cooled tubes?
6. Show by a diagram where the plate ammeter should be connected in a water-cooled triode r.f. amplifier, in order to exclude measurement of the current leakage in the water column.
7. What is the meaning of the term "maximum plate dissipation"?
8. Which of the following ratings gives the *highest* power output (disregarding tube life): 1, the CCS rating; or 2, the ICAS rating?
9. Give two reasons why connecting wires should not be allowed to rest against the glass envelope of a transmitting tube.
10. Which of the following types of filaments may be operated with a lower than normal filament voltage, with a consequent lengthening of tube life: 1, *pure tungsten*; 2, *oxide-coated*; or 3, *thoriated tungsten*?



## VARIED INTERESTS

Don't go stale! Keep a fresh, active interest in everything you do. When you work or when you play—work hard, play hard. When you study, concentrate on study. When you stop working, or playing, or studying—let go. Forget about it. The best vacation is merely a complete change from what you have been doing. Loafing is not a vacation—it is merely boredom.

There is nothing better for an office worker after hours than a brisk walk, a swim or a round of tennis. There is nothing better for an outdoor worker than a quiet hour with a book or a good newspaper, or listening to radio programs. But don't do the same things all the time. Vary your life as much as you can. Cultivate a keen interest in the world of which you are a part.

Keeping alert keeps you young. Keeping interested keeps up your energy. Together these things will make you able to learn more in a given period of time. Finally, the more you learn, the more easily you learn.

J. E. SMITH