

**RADIO-FREQUENCY LINES,
FILTERS, AND COUPLERS**

Finished June 24, 1959 24RC

NATIONAL RADIO INSTITUTE

ESTABLISHED 1914

WASHINGTON, D. C.

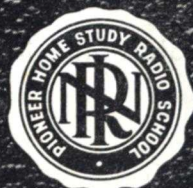

STUDY SCHEDULE NO. 24

For each study step, read the assigned pages first at your usual speed. Reread slowly one or more times. Finish with one quick reading to fix the important facts firmly in your mind, then answer the Lesson Questions for that step. Study each other step in this same way.

- 1. Simple Filters Pages 1-6
The principles of filter operation, particularly basic L types, and their uses, are discussed.
- 2. Complex Filters Pages 7-15
The complex symmetrical pi and T filters, m-derived filters, and crystal filters are the subject of this section. Answer Lesson Questions 1 and 2.
- 3. How Filters and Lines Are Related Pages 16-17
Filters and transmission lines are so similar that we use facts learned about filters to introduce the important subject of transmission lines.
- 4. Tuned R.F. Transmission Lines Pages 18-23
Tuned r.f. transmission lines, their uses, operation, advantages, and disadvantages are studied. Answer Lesson Questions 3 and 4.
- 5. Untuned R.F. Transmission Lines Pages 23-31
How matching the impedance of the transmitter and the antenna to the characteristic impedance of the transmission line eliminates standing waves, and produces the widely used and important untuned r.f. transmission line. Answer Lesson Questions 5, 6, 7, 8, 9, and 10.
- 6. Cause and Prevention of Line Radiation Pages 31-36
Why r.f. energy radiates from most types of transmission lines, and how coaxial cables (which do not radiate) are constructed, and used.
- 7. Start Studying the Next Lesson.

RADIO-FREQUENCY LINES, FILTERS, AND COUPLERS

Simple Filters

EARLIER lessons discussed the transmission of audio-frequency power along telephone lines and cables. We learned that in some cases, depending upon the length of the line and the frequency of the highest audio-frequency signal to be transmitted, the capacity of the line can be neglected; in other circumstances, the capacity cannot be ignored, and it becomes necessary to resort to "line loading" in order to realize an efficient transfer of power.

The higher the signal frequency, the more complex is the operation of a transmission line. The line characteristics and the behavior of transmission lines carrying radio-frequency power is considerably different from those of the low-frequency line. The reason for this is that, at higher radio frequencies, a physically short line may be several wavelengths long. High-frequency lines exhibit resonance and standing wave effects that are not apparent in audio lines.

Such lines, of course, are used extensively in transferring high-frequency power from a transmitter to a remote antenna. Since it is usually impossible to construct an efficient antenna near the transmitter itself, and it is also inconvenient to locate the transmitter directly at the antenna, it is necessary to use r.f. transmission between the transmitter and the antenna.

In this Lesson we shall investigate the most efficient means of feeding radio-frequency power along a trans-

mission line to an antenna that may be separated from the transmitter by a considerable distance.

Remember that we learned that a loaded audio-frequency line behaves as a low-pass filter. This is an important fact. Indeed, it was through the study of the characteristics of transmission lines that the first electric wave filters were devised.

Now we shall study the problem the "other way 'round." Instead of comparing a loaded line to a filter, we shall first consider some relatively simple filters; then, by adding several of these together, we shall build up a more elaborate filter system, and determine under what circumstances it resembles a transmission line. In this way we can easily outline the principles of both filters and transmission lines, and we can understand why these elements behave as they do.

WHAT IS A FILTER?

In general, any device that passes a current of one frequency more easily, or with less loss than currents of other frequencies, may be called an electric filter. Probably the most elementary form of filter is the simple series-tuned resonant circuit.

In the early days of radio, the crystal receiver shown in Fig. 1A was common. By adjustment of the inductance L, the combination of the coil, the capacity C, and the antenna itself could be made series resonant at the desired station frequency. In this way

the desired signals could be passed along and rectified by the crystal detector while the signals on the other frequencies could be rejected to some extent.

The tuning curve, or "filter response," of such a simple arrangement is shown by curve D of Fig. 1C, where the power output is plotted against the carrier frequency. Observe that the response curve is quite broad. This is caused by the relatively low-resistance crystal and headphones being shunted across the inductance L, thereby reducing its efficiency, and also because the antenna is actually a part of the tuned

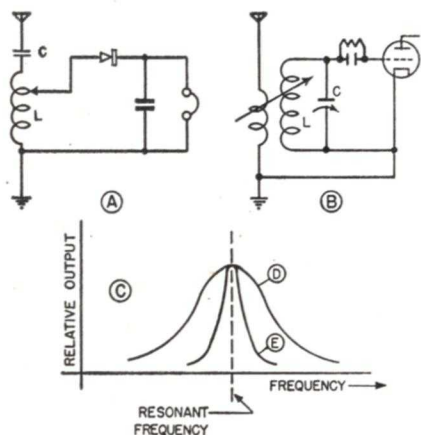

FIG. 1. Relatively low-Q and high-Q tuned circuits, and their respective frequency selectivity characteristics. Note that an increase in sharpness is accompanied by a severe narrowing of the pass band near the circuit resonant frequency.

circuit, and thus its radiation resistance lowers the circuit Q. As a consequence, there is a considerable loss of selectivity.

When triode detectors came into use, and there were more stations on the air to interfere with each other, it became necessary to sharpen the tuning of the receiver at the expense of efficiency. By loosely coupling the antenna circuit to a parallel-tuned circuit,

as shown in Fig. 1B, the Q of the resonant circuit was raised, and the sharpness of response was increased. Thus the "filter" of Fig. 1B had a response like curve E of Fig. 1C.

▶ Although the steepness of the sides of curve E is much greater than that of curve D, it should not be overlooked that the pass band is also much narrower. This is a characteristic of all simple tuned circuits. *Any attempt to increase the rejection of off-resonant frequencies by increasing the Q of a simple resonant circuit always results in a diminished frequency-response band.*

In broadcast reception, the characteristic response of simple tuned circuits usually is sufficiently wide to pass the carrier and the desired side bands, and for this reason, these circuits are widely used in present-day receivers.

For special applications, however, the tuned circuit is not adequate. In multiple carrier telephony, for instance, several carriers, let us say of 20, 30, 40, 50 kilocycles, etc., may be separately modulated with voice frequencies up to 4 kc. before being transmitted simultaneously along the same transmission line. This means that the 20-kc. carrier may have side band frequencies as low as 16 kc., and as high

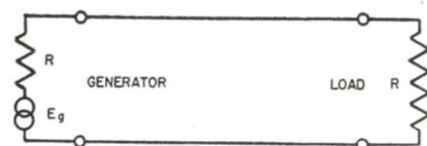

FIG. 2. A network containing nothing but resistance would pass all frequencies from zero to infinity—hence, it would be an all-pass filter.

as 24 kc. Likewise, the 30-kc. carrier may have side bands of 34 and 26 kc., and so on.

At the receiving end, the receiver for each carrier must be capable of accepting, with minimum loss, not only

its own respective carrier, but also the accompanying side bands. At the same time, all other carrier and side-band frequencies must be rejected as much as possible in order to prevent undue interference.

No simple tuned circuit can be expected to accept the 20-kc. carrier with side bands covering a total band of 8 kc., and at the same time present a

matched.) If these are perfect resistors, having no inductance or capacitance, there is no capacitance between the connecting wires, and the source voltage remains constant, then the same amount of power is delivered to the load for every frequency from zero to infinity. This, then, is an "all-pass" filter—no filter at all.

The Low-Pass Filter. If we insert

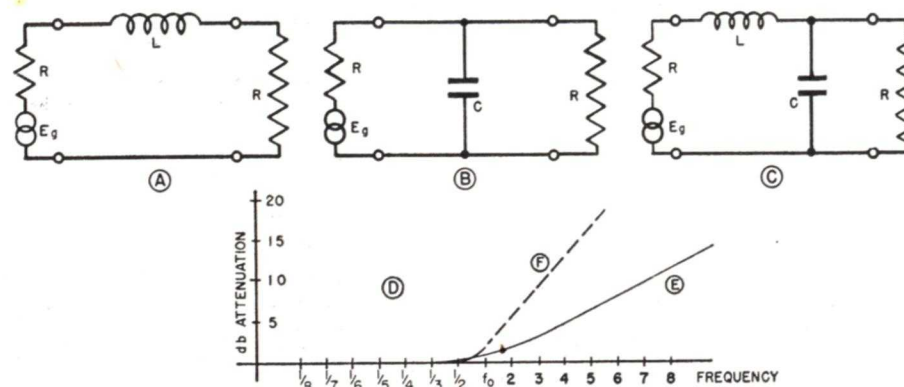

FIG. 3. Either a series inductance, or a shunt capacity can be used to make a simple low-pass filter. By combining these, an improved L-section low-pass filter is formed.

high attenuation to the lower side band of the 30-kc. carrier, namely 26 kc., only 2 kc. away.

Electric wave filters were first constructed for applications like this, where, instead of a single frequency, a relatively wide band of frequencies is accepted or rejected.

L-TYPE FILTERS

A fundamental rule, with regard to electric filters, is that a network cannot act like a filter unless it contains some reactive element, such as an inductance or a condenser that changes its reactance with frequency.

To illustrate, let us look at the resistive circuit shown in Fig. 2. This is a source of alternating current E_g with internal resistance to R which is supplying power to the load resistor R. (The load and source resistances are

a reactive element, such as an inductance L, in series with the load resistor R as shown in Fig. 3A, then we immediately obtain a filter action. At very low frequencies, the inductive reactance of L is low, and most of the generator voltage is developed across the load R. Nevertheless, as the frequency is increased, the inductive reactance increases, and we find less and less current flowing through the load. The attenuation produced by the inductance, therefore, rises with the frequency, and we have the response curve E shown in Fig. 3D.

In this particular curve, the relative attenuation in db is plotted against all frequencies above and below a reference frequency f_0 at which the inductive reactance is equal to the load resistance R. Since this simple network passes low frequencies much easier

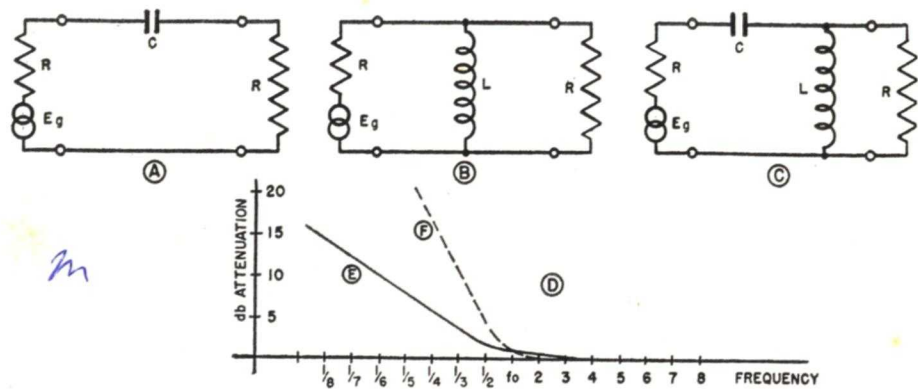

FIG. 4. High-pass action is obtained by using a condenser in series with the load, or by using an inductance in shunt with the load. When used together, a high-pass L section with a much sharper cut-off is the result.

than high frequencies, it is an elementary "low-pass" filter.

We may realize the same circuit performance if, instead of inserting an inductance in series with the load, we shunt the load with a capacity C_1 , as shown in Fig. 3B. As the capacitive reactance is very high at low frequencies, very little current is bypassed through the condenser when the generator frequency is low, but with increasing frequency, the capacitive reactance drops, and we find more and more current flowing through the condenser instead of the load. This again leads to a low-pass response. If the capacitance has a reactance that is equal to the load resistance at the reference frequency f_0 , then we obtain a curve identical to curve E, which is the response for the inductance case.

What happens if we try to combine the effects of a series inductance and a shunt capacitance? This gives us the circuit shown in Fig. 3C. The filtering action is greatly improved. Curve F in Fig. 3D illustrates the results. As we have chosen an inductance and a capacitance so that the reactance of each is equal to the load resistance at the frequency f_0 , these two are resonant at this frequency. Since the voltage

across the condenser in such a series-resonant circuit tends to be high at resonance, the low-pass action is nullified to some extent, and the voltage that is developed across the load resistor R is held nearly constant up to the resonant frequency f_0 . It is only above the frequency f_0 that the attenuation suddenly begins to rise at a rapid rate.

It is appropriate to call the frequency f_0 the "cut-off" frequency, and in accordance with general filter terminology, the frequency region *below* f_0 is called the "pass band," and that *above* the cut-off frequency is called the "stop" or "attenuation band."

The circuit, shown in Fig. 3C, is a basic filter network. Because of its shape, it is commonly described as an "L section."

The High-Pass Filter. High-pass, instead of low-pass response, can be realized if we interchange inductances and capacitances in the circuits shown in Fig. 3. This gives the simple high-pass networks shown in Fig. 4.

The condenser C , shown in Fig. 4A, has a very high reactance at low frequencies, and the reactance decreases rapidly as the frequency increases to give the response curve E in Fig. 4D. The capacitance is chosen to have a re-

actance equal to the load resistor R at the frequency f_0 .

The inductance L , shunted across the load R , shown in Fig. 4B, absorbs most of the generator power at low frequencies. At high frequencies, however, the inductive reactance is very high, and the shunting action is minimized. This, too, gives a high-pass action, and if the inductive reactance at f_0 is equal to the load resistance R , the response is the same curve E shown in Fig. 4D.

The series capacitance and shunt inductance can be combined to give the high-pass L-section shown in Fig. 4C. Here again, the two elements resonate at the cut-off frequency f_0 , and we obtain an improved filter response. This is shown in curve F of Fig. 4D. Note, however, that the pass band is now that region of frequencies *above* f_0 , and the stop band occurs at all frequencies *below* this cut-off frequency.

Band-Pass Filters. In a somewhat analogous manner, it is possible to construct simple "band pass" filter sections. These are networks that have a pass band a definite number of cycles wide, and present high attenuation to all frequencies above and below the desired frequency band.

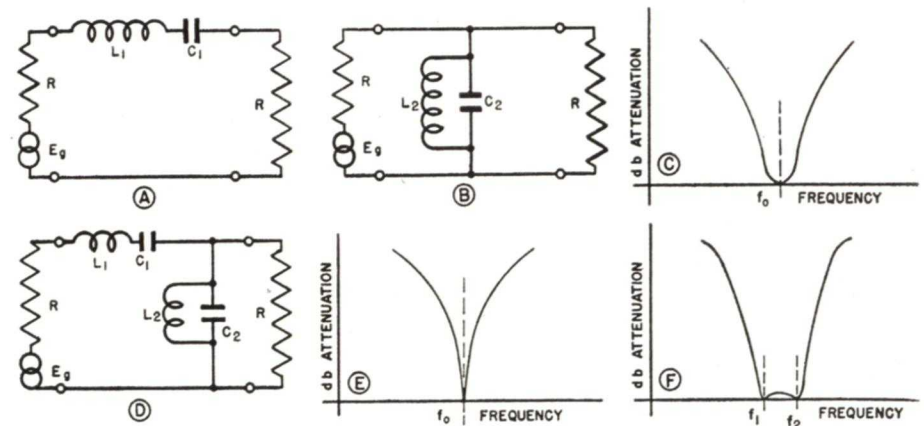

FIG. 5. Series, or parallel-tuned circuits, perform as simple band-pass filters. In combination, the resulting L section may have either a very sharp, or broad-band response.

Let us look at Fig. 5A. Here we have an inductance L_1 , and a capacitance C_1 in series with the load resistor R . This is really a *series resonant* circuit with a very low Q . The attenuation curve is similar to that shown in Fig. 5C.

The same response can be obtained if we shunt a parallel-tuned circuit L_2 - C_2 across the load, as shown in Fig. 5B.

When we combine the series, and shunt elements to form the L section of Fig. 5D, we find that two possibilities of improved filter action present themselves. If the two tuned circuits are tuned to the *same* resonant frequency, the response of the L-section is very sharp, as shown in Fig. 5E. For the two circuits tuned to *different* frequencies, a broader pass band is the result. This is pictured in Fig. 5F. Note that we now have *two* cut-off frequencies, f_1 and f_2 . Also, there are two attenuation bands, one above and one below the desired pass band. The circuit in Fig. 5D, therefore, is appropriately called an "L section band-pass" filter.

Band-Elimination Filters. We know that a low-pass filter can be con-

Complex Filters

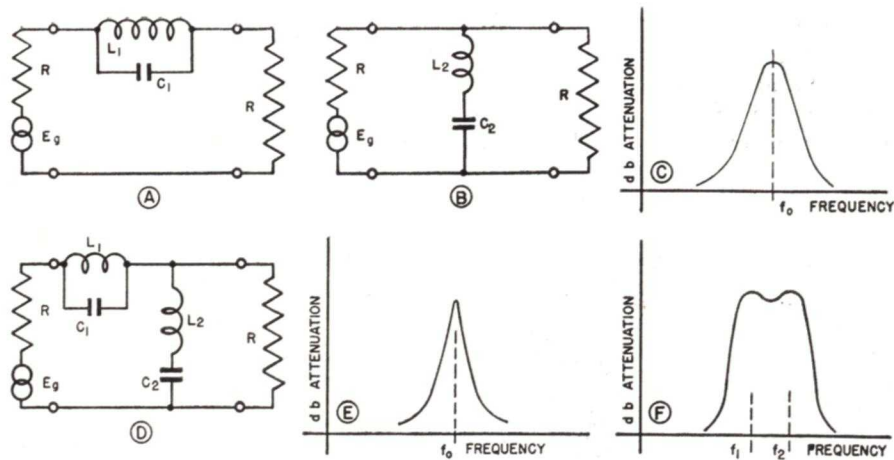

FIG. 6. Band-elimination effects can also be obtained by using resonant circuits. The L section can be designed to reject a narrow band of frequencies or a broad band of frequencies.

verted into a high-pass filter by interchanging the respective elements. The performance of a band-pass filter can also be reversed by interchanging the series-resonant and parallel-resonant circuits. The circuits of Fig. 5 thus become those in Fig. 6.

The parallel-tuned circuit in Fig. 6A has a high impedance at its resonant frequency f_0 , and it effectively blocks any current that may flow to the load. This gives us the attenuation curve of Fig. 6C.

In Fig. 6B, the series-tuned circuit at resonance "shorts out" the load resistance. For proper values of inductance and capacitance, the same re-

sponse curve of Fig. 6C is realized.

When these two circuits are combined to form the L section of Fig. 6D, we can obtain high attenuation at a single frequency, as shown in Fig. 6E, by tuning the two circuits to the same frequency; or by tuning to different frequencies, we can reject a band of frequencies as shown in Fig. 6F. For this latter curve, we again have two cut-off frequencies, f_1 and f_2 . Note, however, that we now have two pass bands, one above, and one below the single attenuation band. Filters that reject a given band of frequencies, but pass all others with little loss, are called "band-elimination" filters.

SYMMETRICAL FILTERS

The low-pass L section shown in Fig. 3C can be made into a symmetrical T section by splitting the inductance L in two, and placing one half on each side of the shunt condenser C, as shown in Fig. 7A. The same L section can be changed into a symmetrical pi section by using two condensers of half the former capacity, and locating one at each end of the inductance as pictured in Fig. 7B.

The db attenuation curves for these two symmetrical sections are identical, and look like those shown in Fig. 7C. Since we have used an additional reactive element in each case, the response curve is improved, there being less loss in the pass band, and a sharper rise in attenuation at the cut-off frequency f_0 .

For frequencies not close to the cut-off, with each network, the generator sees an impedance nearly equal to the load resistance. Furthermore, the impedance, found by looking back into

The L-section filters just discussed are not symmetrical. This means that, in Fig. 3C, for example, the network impedance into which the generator works is not the same as that seen looking back from the load. If the generator and load impedances were originally identical, then the insertion of the filter section has upset the impedance match, so that maximum power transfer can no longer be realized.

In our study of attenuators, we found that the L pad has these same annoying characteristics. In order to obtain equal input and output impedances for an attenuator, it is necessary to use a T pad, pi pad, or some other symmetrical network.

The same is true for all filter sections. It is only when a filter section is identical in shape, as seen from each end, that it may be inserted between a matched source and sink without disturbing the impedance match conditions.

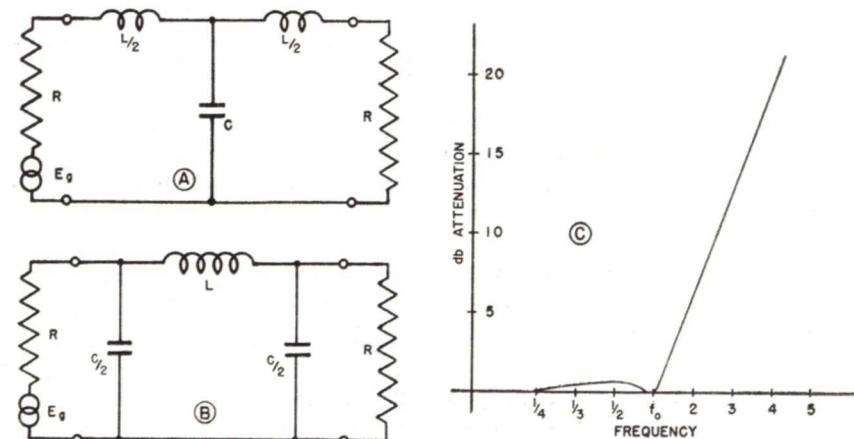

FIG. 7. By making an L section into a symmetrical T section or pi section, the network input impedance for the generator is made the same as the output impedance presented to the load. The cut-off sharpness is also improved, and is the same for both these symmetrical low-pass filter sections.

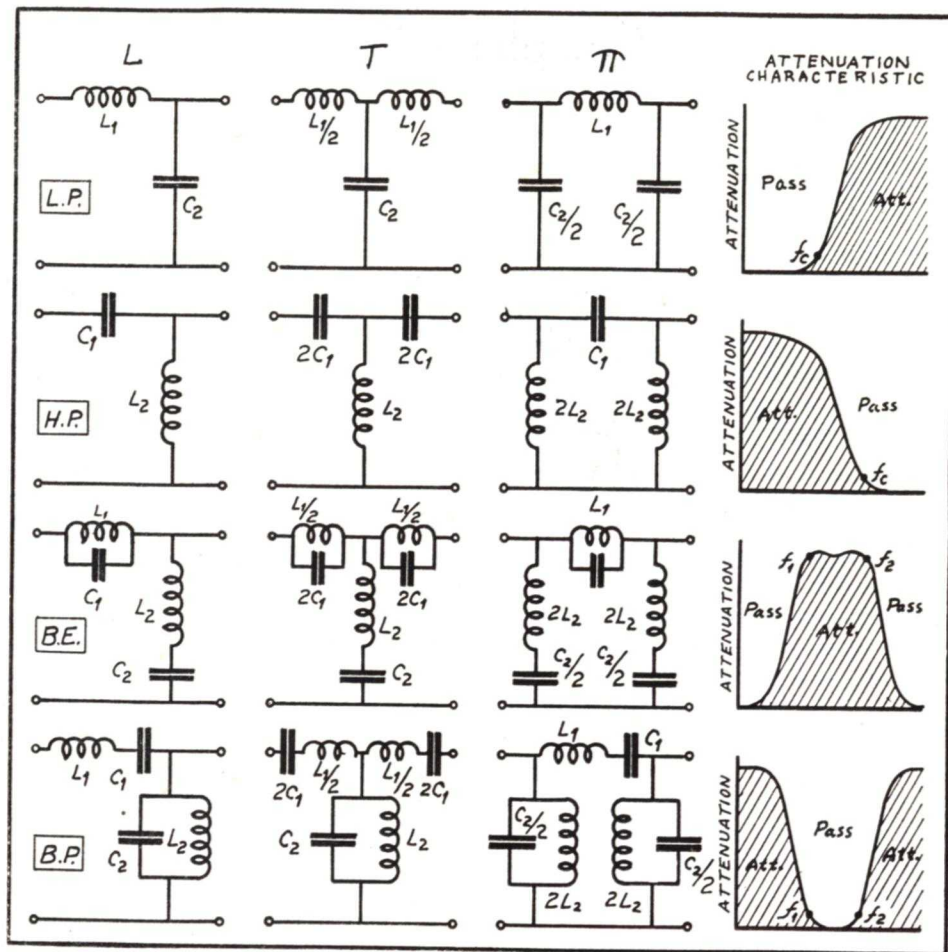

FIG. 8. The most common forms of L, T, and pi sections with their attenuation characteristics for low-pass, high-pass, band-elimination, and band-pass filters.

the networks from the output terminals, is approximately equal to the source, or generator resistance. These symmetrical sections, therefore, can be used between a matched source and sink for the apparent load for the generator, and the effective source impedance at the output is not altered in any way.

In a similar manner, the band pass and band-elimination L sections can also be made into symmetrical T or pi sections. A résumé of the more common filter section forms, together with

their attenuation characteristics, is given in Fig. 8.

Multi-Section Filters. Now that we know that symmetrical filter sections "repeat" the load resistance for their input impedance, it is obvious that we can operate several filter sections in tandem. Thus, if we have three low-pass T sections, each designed for an impedance, let us say of 500 ohms, we can arrange them as shown in Fig. 9A. Here the second section acts as the load impedance for the first, and the input impedance of the last section is

the load for the second filter section.

We may continue this arrangement for almost any number of sections. In all cases, however, the generator still works into a 500-ohm input impedance, and the impedance at the output continues to match the 500-ohm load.

Since we assume that there is no magnetic coupling between the arm inductances L, where two of these arm inductances occur in series they can be replaced by a single inductance that is twice as large. We have then, a simplified low-pass "ladder" filter as shown in Fig. 9B.

In precisely the same manner, high-pass, band-pass and band-elimination multi-section filters can be made. A

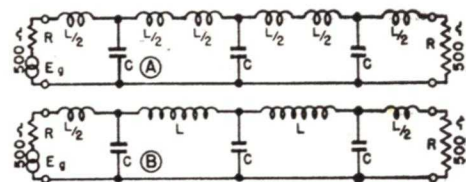

FIG. 9. Illustrating the manner in which three low-pass T sections can be connected in tandem to make a multi-section filter that has three times the filtering action of a single section. Where inductances appear in series, they can be replaced by a single coil, thus reducing the number of components.

high-pass ladder filter, made up of three T sections in tandem, is shown in Fig. 10A. Wherever two arm capacities appear in series, however, the effective capacity is cut in half. These two condensers, therefore, can be replaced by a single condenser. The simplified version of the high-pass ladder filter appears in Fig. 10B.

But why operate several filter sections in tandem? The over-all attenuation of several symmetrical attenuator pads connected in tandem is equal to the sum of the separate losses in each pad. The same is true of filter sections. Thus we can obtain an improved filter response by using a number of filter

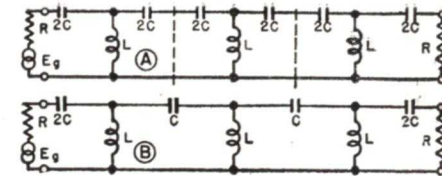

FIG. 10. A three T-section high-pass filter, and the simplified version made by combining series condensers.

sections together.

For example, if a single low-pass T section has the response that is shown by curve 1 in Fig. 11, then two sections in tandem have twice the former attenuation at any one frequency, as illustrated by curve 2. Curves 3, 4, and 5 show the increased attenuation for low-pass ladder filters of 3, 4, and 5 sections respectively. Almost any degree of filtering action can be obtained by increasing the number of cascade sections.

PRACTICAL FILTERS

Study the curves in Fig. 11 for a moment and notice that the cut-off action of a simple ladder filter is not perfect. In curve 1, for example, even though the attenuation is much higher in the attenuation band than in the pass band, there is a definite amount of loss in the pass band near the cut-off frequency. Increasing the number of sections makes the response curve more rounded near the frequency f_0 . This is apparent in curves 2, 3, 4, and 5.

For simple uses, such as in elimina-

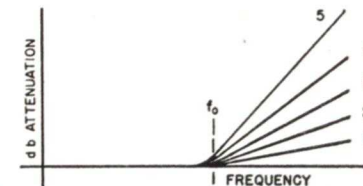

FIG. 11. When a multi-section filter is made by using 1, 2, 3, 4, or 5 identical sections, the over-all attenuation is equal to 1, 2, 3, 4, or 5 times the attenuation of a single section at any given frequency.

tion of a.c. hum from high-voltage rectifier power supplies, this loss in the pass band is of no consequence. We can, for example, make the hum filter cut-off frequency about 10 to 30 cycles so that the attenuation for hum frequencies of 60 and 120 cycles is quite high, and the losses for direct current, which is really zero frequency, is quite small. By increasing the size of the choke coils and filter condensers, we

M-Derived Filter Sections. Let us look at Fig. 12A. This is an ordinary low-pass T section, sometimes called a "constant K filter," with an attenuation characteristic like that shown in Fig. 12B. Since this is a basic filter section, it is often called a "prototype."

Let us modify the inductance and capacitance values of this prototype section so that an additional inductance L_2 can be placed in series with

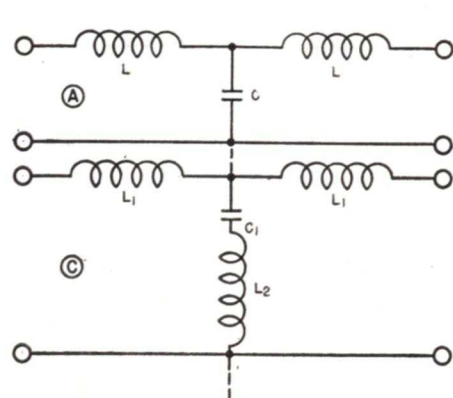
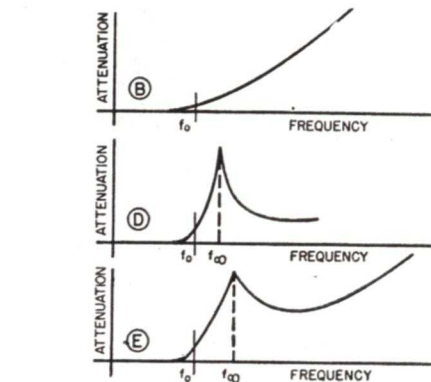

FIG. 12. A prototype section with high attenuation far from cut-off, and a derived section, with high attenuation close to cut-off, when put in tandem make a composite filter with a very sharp cut-off, and a high attenuation over the entire stop band.

can obtain the desired suppression of a.c. components. This is often called the "brute-force" method of filtering. We cannot make the cut-off frequency drop to zero, and except for ohmic losses in the inductances, the losses for d.c. remain unchanged.

Nevertheless, in instances where it is necessary to present a very high attenuation to one band of frequencies, and at the same time pass, with very little loss, an adjacent band of frequencies, we find that the simple ladder filter is inadequate. The separation of numerous carrier telephone signals, as quoted earlier in this Lesson, is an example of precision filter use. For such applications, it is obvious that we must devise a filter with a much sharper cut-off characteristic.



the capacitance C_1 , as illustrated in Fig. 12C. If done properly,* this does not change the section cut-off frequency, and it does not alter the response in the pass band.

In the attenuation band, however, we find that a startling change occurs. Since L_2 and C_1 form a series-resonant circuit, the section is "shorted out" at one frequency, and its response drops nearly to zero. This means that at one

*In choosing the value of L_1 , C_1 and L_2 in the so-called derived filter, shown in Fig. 12C, a factor (or value) is used in special formulas to calculate their values. This factor, called the "m" factor, is determined by another formula based on how sharp the cut-off is to be. Since it is the sharpness of cut-off, or "m" factor, that determines the value of all L and C values in a derived filter, this arrangement is called an "m-derived" filter.

point in the stop band the attenuation is very high, reaching, theoretically, to infinity. In practical circuits, the attenuation does not reach infinity because of losses in the coil, but the response of such an "m-derived" section has a peak of great attenuation, as illustrated in Fig. 12D.

An m-derived section cannot be used alone, since after the infinite attenuation frequency f_∞ is passed, the attenuation again drops to a low value. If, however, we connect a prototype and a derived section together in tandem, we realize a greatly improved filter performance. This means that we add the curve of Fig. 12B to that of Fig. 12D to get an over-all response like that shown in Fig. 12E.

Note that not only is the attenuation relatively high over the entire stop band, but also that the cut-off characteristic is much sharper. Notice also that the losses in the pass band near the cut-off frequency have been held to a minimum which is impossible to realize by merely adding simple prototype sections together.

Fig. 12C does not represent the only practical type of derived filter section. The low-pass pi-section prototype in Fig. 13A, for instance, can be modified to appear as the derived section in Fig. 13B. The added condenser C_2 , in conjunction with coil L_1 , now forms a parallel-tuned circuit, which at its resonant frequency serves to block the flow of current through the section. Here again, the result is an infinite-attenuation frequency in the stop band.

In constructing a multi-section filter, it is possible to use several derived sections. Furthermore, if different m values are used for each derived section, a separate infinite attenuation frequency for each section is obtained. In this way the over-all filter-response characteristic can have an extremely

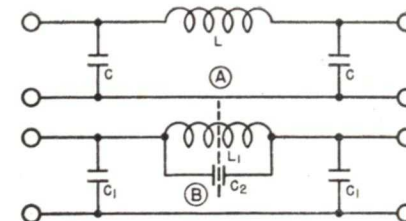

FIG. 13. A prototype low-pass pi section, and the corresponding m-derived section. Where the parallel-tuned circuit is resonant, the derived section has infinite attenuation.

sharp cut-off, and very high attenuation at all points in the stop band. The typical response of a low-pass multi-section filter, using a prototype and three derived sections, looks like the curve shown in Fig. 14. In general, filters that are made up of a prototype and one or more derived sections are called "composite" filters.

The Input-Output Impedance of a Filter. In earlier paragraphs we stated that symmetrical filter sections like those shown in Figs. 7A and 7B possess input impedances that are nearly equal to the respective load resistances. Let us investigate this statement further.

Any symmetrical filter section has a characteristic or "iterative" impedance that is determined entirely by the values of inductance and capacitance. It is only when the load resistance is made equal to this inherent characteristic impedance that the input impedance of a filter assumes an identical value. In other words, for proper filter

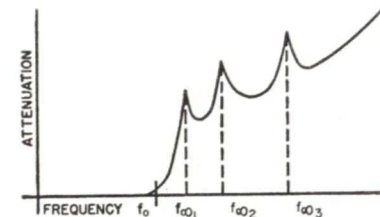

FIG. 14. The typical attenuation characteristic of a composite filter made up of a prototype, and three different m-derived sections.

performance, it is desirable that we use source and sink impedances that match the impedance of the filter itself.

Extremely long audio-frequency transmission lines, that we have previously studied, also exhibit this characteristic impedance property. With them, too, it is necessary to use generator and load impedances that are equal to the characteristic impedance of the line for efficient operation.

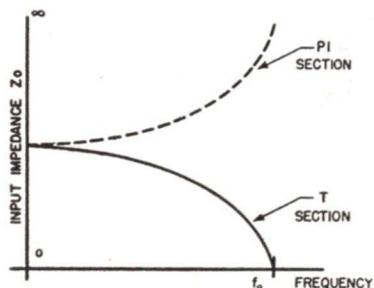

FIG. 15. The characteristic impedance of a prototype T section drops to zero at the cut-off frequency, and that of a pi section rises to a very high value.

Unfortunately, the characteristic impedance of a simple prototype filter section is not constant with frequency. Look at the low-pass T section in Fig. 7A to see why this is so. In the input terminals, the left-hand inductance arm $L/2$, and the shunt capacity C , together form a series-resonant circuit. Since these two are in resonance at the section cut-off frequency, the input impedance drops to a very low value at this point. In Fig. 15, the heavy curve shows how the characteristic impedance of a low-pass T section decreases rapidly from a nominal value for low frequencies to a theoretical zero value at the cut-off point.

On the other hand, the low-pass pi section in Fig. 7B resembles a split-condenser parallel-tuned circuit, and it behaves like a parallel resonant circuit. For low frequencies, the section

has a nominal characteristic impedance. As the frequency is raised, the input impedance increases, and at the cut-off point where the elements are resonant, the impedance approaches an infinite resistance. The dotted curve, shown in Fig. 15, shows this typical impedance change for a pi section.

Although these two filter sections have identical attenuation characteristics, as shown in Fig. 7C, their im-

pedance variations are strikingly different. In general, it may be said that the impedance of any T section drops nearly to zero at a cut-off point, and that of any pi section rises to a very high value.

How can we match a source and sink to a filter if the characteristic impedance of the filter varies so widely over the pass band?

In a great many filter applications where it is not necessary to work very close to the cut-off frequency, the change of filter impedance is not serious. In such cases, the impedance variation is ignored, and the source and sink impedances are chosen to be equal to that of the filter at frequencies far removed from its cut-off frequency. This gives fair filter performance.

Under these conditions, however, the

mismatch at cut-off substantially decreases the cut-off sharpness. For more accurate work, it is necessary to find a better method of matching the changing filter impedance. This is done by a special type of T section to match a T section, or a special type of pi section to match a pi section.

Terminating Half-Sections. Let us suppose that the m-derived pi section, shown in Fig. 13B, is split in half as indicated by the dotted line. If we consider only the right half, we have the "half section," shown in Fig. 16A.

Now looking into the terminals 3-4, this half section appears as a pi section. Any full pi section, therefore, can be attached to these terminals without an impedance mismatch, since the two networks have the same impedance at all frequencies.

Looking into the terminals 1-2, however, the input impedance has some peculiar characteristics. For instance, at terminals 1-2 the half-section resembles a T section, and the input impedance can be expected to drop to zero at the cut-off frequency. We find, nevertheless, that the manner in which this impedance drops to zero depends entirely upon the value of the multiplying factor m that we used to derive the total section in the first place.

If a value $m = 1$ is used, the half-section impedance varies like a prototype T section. This is shown by curve 1 in Fig. 16B. For lower values of m , the input impedance is more constant

over the pass band. The input impedance variation for $m = 0.8$ and $m = 0.6$ is illustrated by curves 2 and 3, respectively. For still smaller values of m , let us say $m = 0.4$ and $m = 0.2$, the input impedance may rise to a high value before it drops abruptly to zero. See curves 4 and 5.

A value $m = 0.6$ gives the best performance, and results in a half-section

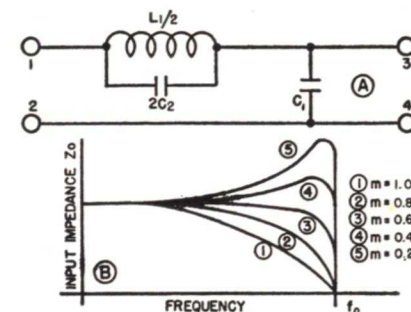

FIG. 16. A terminating half-section, and the variation of its characteristic impedance with frequency for different values of the multiplying factor m .

input impedance that is very nearly constant over about 80% of the filter pass band.

We can use half sections like the one shown in Fig. 16A to match a constant-impedance generator to the variable impedance of a full pi section, or a number of pi sections in tandem. Furthermore, we can use an additional half section at the filter output to match the filter to a constant-impedance load.

A composite low-pass filter, made in

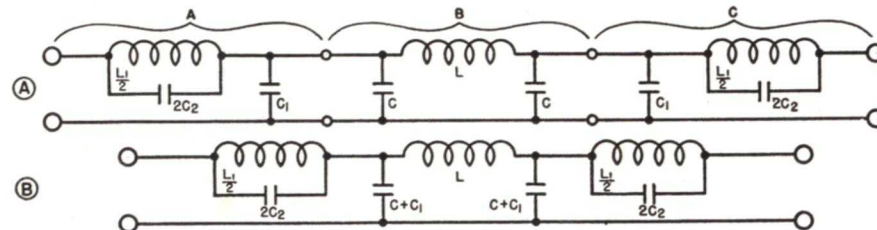

FIG. 17. Above, a composite low-pass filter is made by using a prototype pi section and two constant-impedance terminating half-sections. Below, the simplified filter, after combining parallel capacities.

this manner, is shown in Fig. 17A. The portion marked B is really the prototype pi section of Fig. 13A. The two terminating half sections, A and C, are made by splitting the derived pi section of Fig. 13B.

As two condensers in parallel can be replaced by a single capacity, the composite filter can be simplified as shown in Fig. 17B.

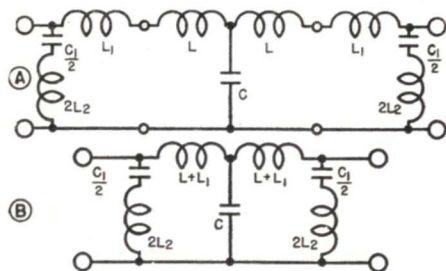

FIG. 18. The use of a T-section prototype with appropriate half sections to make a low-pass composite filter. The network is simplified by replacing two inductances in series, with a single inductance equal to their sum.

Since two half sections have the same attenuation characteristics as a full-derived section, the over-all response of this filter looks like that shown in Fig. 12E. The half sections have three uses: (a) they present a nearly constant impedance at each end of the filter; (b) they sharpen the cut-off response; (c) they supply an infinite attenuation at one point in the attenuation band.

In a similar manner, it is possible to construct half sections that accurately match a T-section filter. Thus, half sections, from the network shown in Fig. 12C, can be used to terminate a prototype T section like that shown in Fig. 12A. This gives the composite filter that is shown in Fig. 18A, which in turn, can be simplified as shown in Fig. 18B. The half sections not only provide a good impedance match between source and filter, and between filter and load, but they also improve

the general filtering action. The response curve for this composite filter is similar to Fig. 12E.

The Crystal Filter. In recent years, many filters have been devised by using one or more piezo-electric quartz crystals as active filter elements. This is possible because such crystals behave as very high Q resonant circuits.

Neglecting its slight losses, the quartz crystal, shown symbolically in Fig. 19A, has an equivalent electrical circuit like that shown in Fig. 19B. The inductance L and capacitance C_1 are a direct result of the crystal mechanical resonant properties and its piezo-electric effect. The capacitance of the electrode plates with the quartz as a dielectric between them is shown as C_2 .

The circuit in Fig. 19B has two resonant frequencies. It is series resonant, and hence has a very low impedance at the frequency f_1 for which the capacitive reactance of C_1 is equal to the inductive reactance of L. Slightly higher in frequency at f_2 , the circuit is

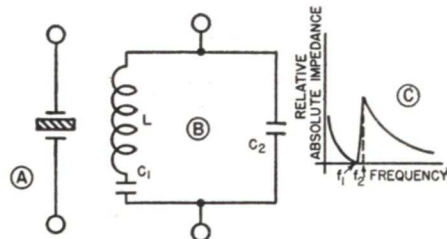

FIG. 19. The quartz crystal, its equivalent circuit, and the rapid changes in absolute impedance for small variations in frequency.

parallel resonant, and exhibits an extremely high impedance. This occurs when the reactance of C_2 is equal in amplitude, and opposite to the difference in reactance between L and C_1 . The wide variation in crystal impedance is shown by the curve in Fig. 19C.

The Q, ratio of inductive reactance

to resistance, of crystals may be as high as 20,000. This means that such crystals are more than 100 times as selective as the average coil-condenser tuned circuit. Furthermore, the very low and extremely high impedance points marked by the series and parallel resonant frequencies f_1 and f_2 , as

impedance source that feeds energy directly through the crystal to a low-impedance load. The crystal, therefore, blocks all frequencies, except those very near its low-impedance series resonant frequency. The condenser C, usually called a "phasing" condenser, is a neutralizing condenser that

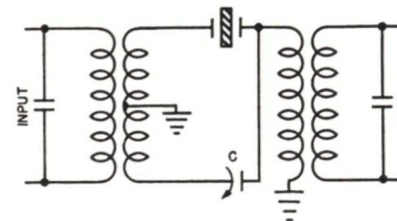

FIG. 20. A simple crystal filter commonly used in the intermediate-frequency amplifiers of communications receivers.

pictured in Fig. 19C, may be separated by as few as 5 cycles, even though the frequencies f_1 and f_2 may be about 50 kilocycles.

It is not surprising, therefore, that several quartz crystals ground to different frequencies, and made into a composite filter give some very sharp cut-off characteristics.

A simple type of crystal filter that is used in the i.f. amplifiers of many communication receivers is illustrated in Fig. 20. The upper half of the push-pull input transformer acts as a low-

feeds in voltage 180° out of phase with the stray signal passed by the crystal electrode capacity.

In other words, this circuit is a form of bridge. At frequencies that are far from crystal resonance, the bridge is balanced by adjustment of the phasing condenser C so that no signal passes to the output. Near the crystal resonance frequency, however, the impedance of the crystal is low; the bridge, therefore, is unbalanced, and the designed signals are allowed to pass through.

How Filters and Lines Are Related

Although all the filters described have different characteristics, some high-pass, some low-pass, etc., notice that they have the same over-all pattern, that is, each one is composed of a ladder-like assembly of series and shunt impedance elements. Because of this shape, they are called "ladder" filters.

And as we mentioned earlier in the Lesson, every filter section contains at least one reactive element, in other words, at least one inductance or capacitance. This means that there is a phase shift between input and output voltage for any type of filter section.

Let us examine Fig. 21A. This is a multi-section low-pass filter made of eight prototype pi sections.

At very low frequencies, the effect of the inductances is slight, and the voltages at points 2, 3, 4, etc., are nearly in phase with the input voltage e_i at point 1. As the frequency is increased, however, both the series inductances, and the shunt capacitances play a prominent part. The voltage at point 2 lags behind that at point 1, and the voltage at point 3 falls behind that at point 2, and so on, for the entire length of the filter.

Finally, at the cut-off frequency of the filter, we find that the voltage at point 2 is 90° behind the input voltage e_i . Likewise, the phase of the voltage at point 3 is 90° lagging that at point 2. In other words, each filter section introduces a voltage phase shift of 90° , and the over-all phase shift between input voltage e_i and output voltage e_o is equal to the sum of the phase shifts in each filter section. In this particular case, since we have eight sections, the over-all phase lag at filter cut-off is $8 \times 90^\circ = 720^\circ$, or exactly two full

cycles of the sine wave input voltage.

To indicate the relative voltage phase shift at each point by small arrows, we draw them as shown in Fig. 21B. Arrow 1 represents the phase of the input voltage e_i at one particular instant. Arrow 2 shows the phase of the voltage at point 2 at the same instant. This arrow is 90° behind arrow 1. In a similar manner, arrows 3, 4, 5, etc., represent the relative phase of voltage at other points along the filter, all are considered at the same instant of time.

If we connect the arrow tips together by a dotted line, as shown in Fig. 21B, we trace out two cycles of a sine wave. This dotted line represents an electric voltage wave traveling down the length of the filter. The rate of travel of this voltage wave is such that one particular voltage peak spans the length of the filter in the time of two alternating current cycles. For its cut-off frequency, this filter is two wavelengths long, and each filter section is $1/8$ of this or a quarter wavelength long.

Since the phase shift per filter section is proportional to the frequency, somewhere in the pass band between zero frequency and the cut-off point, we find a frequency for which each section has a phase shift of only 45° . Each section, therefore, is $1/8$ wavelength long, and the entire filter has an electrical length of exactly one wavelength.

We see then, that the pattern of voltage values at different points along a multi-section filter corresponds closely to the voltage distribution brought about by electric waves traveling along a transmission line.

We can carry the comparison even further. Each section of the filter in Fig. 21A, and consequently the entire

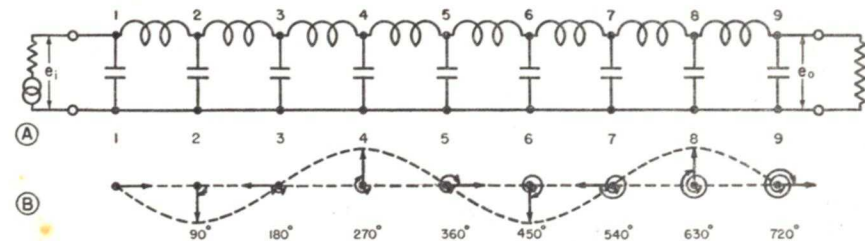

FIG. 21. The different voltage phases found along a multi-section filter can be considered the effect of an electric wave traveling along its length. Filter behavior thus is the same as that of a transmission line.

filter, has a definite characteristic impedance. If the load at the sink end of the filter is made equal to this characteristic impedance, then all the energy carried by the filter is delivered to the load, and there is no mismatch or reflection loss. This is analagous to the transmission line that is terminated by its own characteristic impedance.

If, however, the filter load does *not* match the filter impedance, the filter does not perform properly. This condition causes a mismatch loss, and a reflected wave may be sent back down the filter to the original driving source. As a result, the input impedance of the filter depends upon the character of the load, and the electrical length of the filter itself. The original and reflected waves, traveling in opposite directions, develop standing waves along the filter length. In these circumstances, the filter behaves like a tuned transmission line several wavelengths long.

In Fig. 21A, the filter is made of a relatively small number of sections. Such a filter can be made by using inductances and capacitances 100 times smaller, and employ 100 times as many sections. Although the cut-off frequency is changed, the over-all electrical length remains the same.

Let us suppose that we use an infinite number of sections, and each section has an infinitesimally small inductance and capacitance, then in the end nothing is left but a pair of wires. In other words, all that we have done is substitute *distributed values* of inductance and capacitance for *lumped values* of the same reactances. Instead of speaking of inductance and capacitance "per section," we consider inductance and capacitance "per unit length."

We see, therefore, that a low-pass filter can be considered as a form of transmission line. As a matter of fact, filters are often called "artificial lines."

Tuned R. F. Transmission Lines

In a previous Lesson on simple antennas, we found that an electric wave can be transmitted along a single long wire. We also learned that some of the electric energy can be reflected by the end of the wire, and that a reflected wave can be sent back down the wire to the generator. The resultant effect of these two waves traveling in opposite directions, leads to the development of standing waves along the length of the wire. If the wire is a half-wavelength long, we have the voltage and current standing waves as shown in Fig. 24A. If we attach a high-frequency oscillator, or generator as shown, electric waves travel down both wires in the direction of the heavy arrow. The waves in each wire are of opposite polarity, since the respective wires are attached to opposite terminals of the generator. When these original waves strike the open ends of the wires, their energy is reflected as it is in an antenna. This results in reflected waves

Since we learned that the impedance of such a resonant wire at any point is equal to the voltage divided by the current at the same point, we can see that the generator shown in Fig. 22A is working into a very high impedance. Because the antenna is fed at a maximum voltage point this is called "voltage feeding."

On the other hand, we can employ "current feeding" by driving the antenna at the low-impedance center, where we find a current loop (maximum) and voltage node (minimum). This is illustrated in Fig. 22B.

We also learned that by locating the antenna away from the transmitter, we can feed energy to it by means of a tuned radio-frequency transmission line. Thus, in Fig. 23A, we have a "voltage feed" tuned transmission line, and in Fig. 23B we have a tuned transmission line that is "current feeding" the remote antenna.

We can see by the heavy and dotted curves that standing waves are also developed along the transmission lines themselves. Nevertheless, these two lines cannot be the same, for we know

that the antenna in Fig. 23A is being driven at a high impedance point, and the line in Fig. 23B is working into a very low impedance junction.

What are the characteristics of such lines, and how do they behave? Let us study some of their properties.

STANDING WAVES ON TRANSMISSION LINES

Let us suppose that we have a pair of long wires that are separated by only a few inches, as illustrated in Fig. 24A. If we attach a high-frequency oscillator, or generator as shown, electric waves travel down both wires in the direction of the heavy arrow. The waves in each wire are of opposite polarity, since the respective wires are attached to opposite terminals of the generator. When these original waves strike the open ends of the wires, their energy is reflected as it is in an antenna. This results in reflected waves

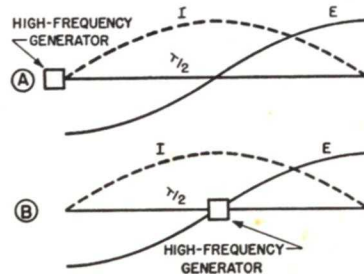

FIG. 22. Above, voltage-feed at a high-impedance point, and below, current-feed at a low-impedance point to set up standing waves on a half-wave antenna or dipole.

being sent back to the generator. Reflected wave travel is in the direction of the dotted arrow.

These original and reflected waves, traveling in opposite directions, aid or cancel each other at different points, so that voltage and current standing waves are developed along the wires.

This action is the same as that in an open antenna wire.

Once standing waves are developed, some peculiar characteristics present themselves. The effective impedance at different points along the wires, for instance, is not constant, and there are

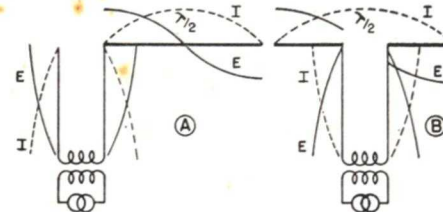

FIG. 23. A, voltage and, B, current standing waves on both antenna and resonant line for voltage-feed and current-feed systems.

some resonant effects between the length of the wires and the frequency of the driving oscillator.

THE HALF-WAVE LINE

If the wires, shown in Fig. 24A, are trimmed to the proper length, or the frequency of the generator is adjusted to the natural resonance of the line, we find that we can set up the standing wave pattern that is shown in Fig. 24B. In this case the line is one-half wavelength long for this particular frequency. Maximum values of voltage and current are indicated by the solid and dotted curves, respectively.

The open ends of the wires constitute a very high impedance. This is borne out by the fact that zero current and maximum voltage occur at this point. Notice the voltage-current conditions at the generator. Although the phases have been reversed, there is still a voltage loop and a current node at this input point. The generator is, therefore, working into the same high impedance. As far as the generator is concerned, the half-wave line repeats the open circuit at the wire ends.

But does this action always hold true? Let us suppose that, instead of

an open circuit, we short-circuit the remote end of the parallel-wire line, as shown in Fig. 24C. What happens? Since the short circuit also represents a sudden change in wire impedance, energy is again reflected at this point, and standing waves can be set up as before. This time, however, the voltage at the short circuit is zero, while the current is high. The result is the standing-wave pattern in Fig. 24C.

The short circuit is a very low impedance as evidenced by the current loop and voltage node. As we go back down the line to the generator, we find that the wave pattern has been shifted from the pattern in Fig. 24B, and at the generator we find zero voltage and a high current. Thus, if there were no

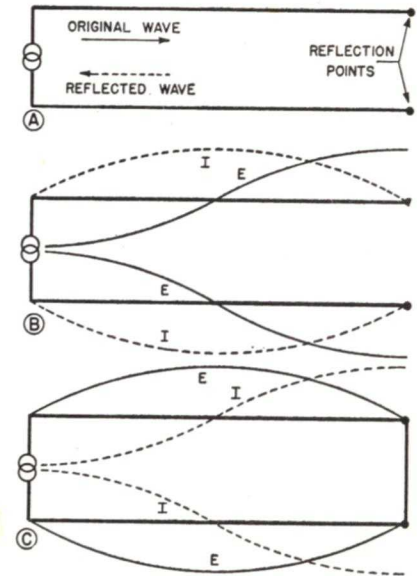

FIG. 24. The voltage and current standing waves set up along open and shorted half-wave lines.

losses in the line, the generator would be working into an effective short circuit. As before, the half-wave line repeats the impedance attached to its remote termination.

► This emphasizes an important characteristic of a half-wave line. By using

any value of load resistance, from a short circuit to an open circuit, the input impedance of the line always assumes an identical value. Even by terminating a half-wave line with an inductance or a capacitance, the input to the line appears as an inductance or a capacitance of the same value.

Furthermore, since the voltage and current conditions at both ends of a line are always the same for any whole number of half-waves, we find this one-to-one transformer action present in lines any number of half-waves long. Thus, we can use a line that is one full wavelength, 3/2 wavelength, or two wavelengths, etc., and still obtain the same impedance-repeating characteristics.

THE QUARTER-WAVE LINE

If the line in Fig. 24A is cut in half, or the frequency reduced to one-half its former value, we find the standing-wave pattern of Fig. 25A set up along the line. In this instance the line is operating as a quarter-wave resonant line.

The open circuit represents a high impedance, and we find zero current and maximum voltage at the wire ends. Note, however, that the voltage-current conditions at the generator are very different from the half-wave case. At the line input we have nearly zero voltage, and a very high current. This means that the generator is working into a theoretical zero impedance; yet the impedance at the line termination is practically infinite. It is apparent that the quarter-wave line has inverted the effective load impedance.

The quarter-wave line always performs in this manner. Let us suppose that we short-circuit the line termination as shown in Fig. 25B. We now have a high current, and a very low voltage at the line termination, and

conditions are changed at the generator terminals. The generator now supplies very little current, but a very high voltage to maintain the standing waves. In other words, the impedance that the generator sees has been made to look like an open circuit.

► This impedance-inverting characteristic of a quarter-wave line is an important one. In general, we find that a line, any odd number of quarter-waves

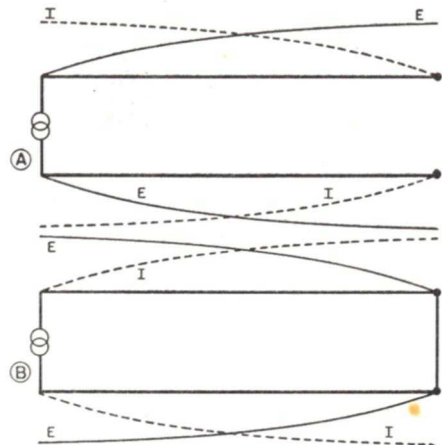

FIG. 25. The standing waves developed along open and shorted quarter-wave lines.

in length, performs the same way. Whenever the line is loaded with a low resistance, the generator works into a high resistance; conversely, if the line is terminated in a high value of resistance, the generator works into an effective low resistance.

If we attach a condenser to the load end of a quarter-wave line, the generator sees an inductance, and for the opposite case, the input to the line looks like a capacitance, if an inductance is used as the line load.

The quarter-wave line is useful as a means of transmitting radio-frequency power. It transfers power from a transmitter to a remote antenna, and can also be used for impedance-transforming purposes at the same time.

The tuned lines shown in Figs. 23A and 23B are quarter-wave lines. In Fig. 23A, the line is attached at a high-impedance point on the antenna, but because of the impedance inversion by the quarter-wave line the transmitter works into a very low impedance. The opposite conditions hold true in Fig. 23B. Here, the antenna is being fed at a low-impedance point, but the r.f. power source delivers power into a relatively high impedance.

LINES OF OTHER LENGTHS

The input to a line, assuming a resistive load, appears as a pure resistance only when the line is resonant, that is, a quarter wave or half wave long, or some multiple thereof.

In Fig. 26 is shown how open-circuit lines of various lengths may have different input impedances. In Fig. 26A, for example, we have an open line that is shorter than a quarter wavelength, and the input is a capacity that is made up largely of the capacity between the wires themselves.

In Fig. 26B is shown a line one-quarter wavelength long. The line inverts the open circuit at its end, and the input impedance assumes a value that is close to a short circuit. The line then behaves in a manner similar to a series-tuned resonant circuit.

A line that is longer than one-quarter wavelength, but shorter than one-half wavelength, appears to the generator as an inductance as shown in Fig. 26C. Why this is so can be more easily understood if we "break" the line, as shown in the figure. The small portion of line at the right, being shorter than one-quarter wavelength, actually appears as a capacitance. The full quarter wavelength portion of the line at the left, however, inverts this capacitance, so that the generator sees an inductance.

For a full half-wave line, as shown in Fig. 26D, the open circuit is repeated in the manner described earlier. The input to this line, therefore, resembles a high-impedance parallel-tuned circuit.

Short-circuited lines behave in a similar, but not identical, manner. Short-circuit lines of various lengths are shown in Fig. 27. In Fig. 27A we have a shorted line that is shorter than one-quarter wavelength, and behaves as an inductance.

For a full quarter-wave shorted line, we know that the input impedance is very high, because of the inversion characteristic. This is shown in Fig. 27B. Such a line resembles a parallel-tuned circuit.

In Fig. 27C we have a shorted line that is longer than one-quarter, but

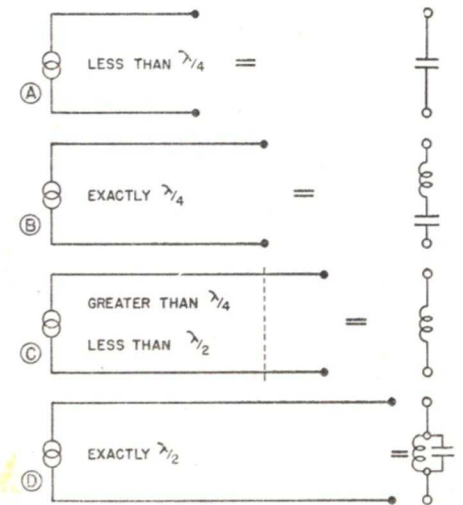

FIG. 26. The inductive, capacitive, or resonant characteristic input impedance for open-circuit lines of various lengths.

less than one-half wavelength in length. In this case, the small portion at the right of the dots appears as an inductance, but the quarter-wave portion at the left inverts this reactance so that an effective capacitance is presented to the generator.

For the full half-wave shorted line, we know that the input impedance is identical to the load impedance. The generator in Fig. 27D, therefore, sees a virtual short circuit in the same manner as though it were working into a series-tuned circuit.

Tuned transmission lines for feeding an antenna do not always have to be cut to an exact length. See Figs. 26 and 27. Let us suppose that we construct a voltage-fed "zepp" antenna like that shown in Fig. 23A. Ideally, we cut the feeder line an exact quarter-wave long. If it is necessary to make the line shorter than this, we find that it appears as a capacitance, as shown in Fig. 26A. Nevertheless, we can still use the line if we insert the variable loading coils as illustrated in Fig. 28A. The added inductance, together with the capacitance of the line itself, forms a series-resonant circuit that can be tuned so that the apparent electrical length of the line is a quarter-wave, although it is physically too short.

On the other hand, a line that is too long appears as an inductance. See Fig. 26C. Such a line can be shortened by

inserting tuning condensers in the manner shown in Fig. 28B. In this case, too, we have a series-resonant circuit—this time it is made up of the tuning condenser, and the inductance of the line itself. The line that is too long, therefore, can be tuned to resonance, so that it appears as a pure resistance

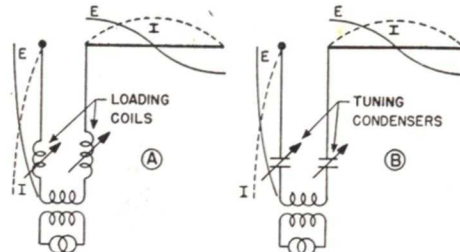

FIG. 28. A, the method of increasing the electrical length of resonant feeders that are too short by inserting loading coils, and B, the shortening of feeders that are too long by using series-connected tuning condensers.

to the generator, and performs as a true quarter-wave line.

This manner of line loading, of course, can be carried too far. We do not expect to make a half-wave line into a quarter-wave line by this method, for it is very improbable that sufficient power can be fed into the antenna, because of a very serious impedance mismatch. Nevertheless, it is quite easy to adjust any line that is as much as 25% too long, or 25% too short.

TUNED-LINE DISADVANTAGES

Tuned lines are satisfactory for transferring radio-frequency power over relatively short distances, but when the transmitter and the antenna are more than 2 or 3 wavelengths apart, these lines are seldom used. There are two principal reasons for this:

1. Although the radiation from one wire of a tuned line tends to cancel that from the opposite wire, since the

two are of opposite polarity, this cancellation is not perfect, and some residual stray radiation occurs. For short lines, this is of no consequence. For extended lines, however, the stray radiation increases in proportion to the length of the line, and may actually distort the radiation pattern of the antenna. This is an undesirable condition. Furthermore, since the line is usually close to the ground, trees, or other conducting objects may absorb and waste much of the line radiation, and hence, some of the transmitter power.

2. Because tuned lines have standing waves on them, the current flowing at the current loops may be very high. Since the power that is lost in heating

the line is equal to the *square* of the current times the ohmic resistance of the line, an appreciable amount of power can be dissipated at the current loops. For a short line, with one or two current loops, this loss is usually not serious, but for an extended line that is many wavelengths long, the total power that is lost may be even more than the power that is delivered to the antenna.

From these considerations we can see that a radio-frequency transmission line operates more efficiently if we eliminate the standing waves along the line. Many lines of this kind are now in use. Let us see how they are constructed.

Untuned R. F. Transmission Lines

Previous discussions of standing waves on wires and lines pointed out that these standing waves are the result of an original electric wave that is traveling from the generator to the load, and a reflected wave that is traveling in the opposite direction from the load to the generator. The reflected wave, too, always originates from an open circuit, short circuit, or some other reflection point where the impedance of the transmission line has an abrupt change in value. It follows then, that if we load a line in such a manner that there is no apparent change in impedance at the load, there is no reflection of energy, and consequently, no standing waves.

Let us look at Fig. 29. Here we have a radio-frequency source with an internal resistance R_g feeding power into a long transmission line. The line, in turn, is transferring this power to a load resistance represented by R_L . As we learned in our study of extended audio-frequency transmission lines,

all lines have a *characteristic or surge impedance* that is determined by the manner in which the line is constructed. This is indicated by the symbol Z_0 in the figure.

What happens if we make the load resistance R_L equal to the line characteristic impedance Z_0 ? Under these circumstances, an electric wave that is coming from the generator sees, upon arrival at the load, the same impedance as though an infinite length of line were

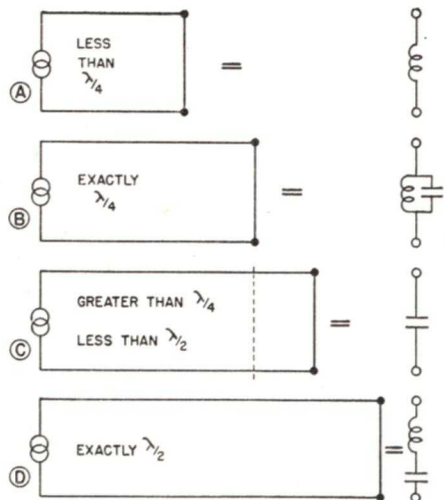

FIG. 27. The characteristic input impedance for short-circuited lines of different lengths.

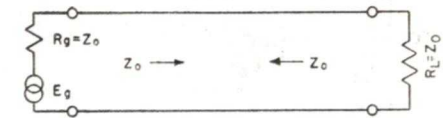
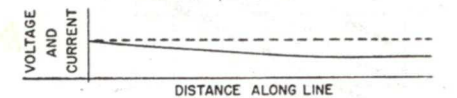

FIG. 29. For an untuned line, both generator and load impedances are matched to the characteristic impedance Z_0 of the line: There are no standing waves. Current and voltage are almost constant throughout the length of the line.

connected instead of the load. The load, therefore, absorbs all the energy of the wave (there is no reflection), and no standing waves can be built up along the line. This is desirable.

Furthermore, as shown by the curve in Fig. 29, without standing waves, the voltage and current values along the line are nearly constant, although they are slightly lower at the load, because of ohmic losses in the line. This means that the line requires no tuning and can be made any convenient length.*

For maximum efficiency, the generator resistance R_g , shown in Fig. 29, must also be made equal to the line impedance Z_o . This has nothing to do with the elimination of the standing waves, but provides proper impedance

*Notice that even if the line is a quarter or a half wave long, terminating it in Z_o means that the input impedance is Z_o .

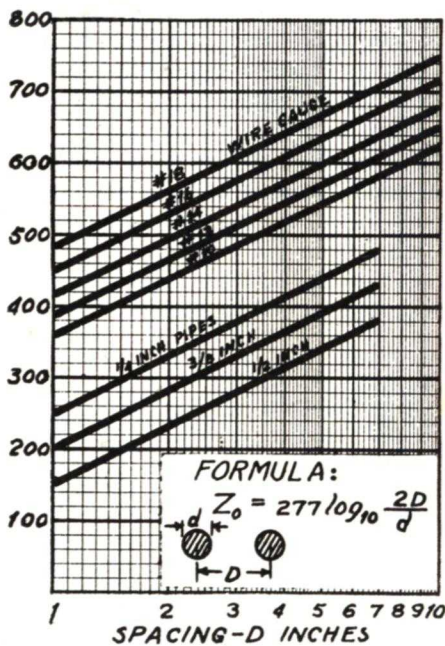

FIG. 30. Chart for determining the characteristic impedance of open-wire lines of various physical dimensions. Effective dielectric is assumed to be air.

matching for a maximum transfer of power between the generator and its load, which, in this case, is the characteristic impedance of the line itself.

► In summary, a radio-frequency transmission line can be operated efficiently without standing waves if the source impedance, as well as the load impedance, is matched to the characteristic impedance of the line.

CHARACTERISTIC IMPEDANCE

But what is this characteristic, or surge impedance, that is so important? When we studied filters, which also have a characteristic impedance, we found that this property depended upon the inductance and capacitance *per section*. In r.f. transmission lines, as with audio-frequency lines, this impedance is determined by the effective inductance and capacitance *per unit length*. These line reactances, in turn,

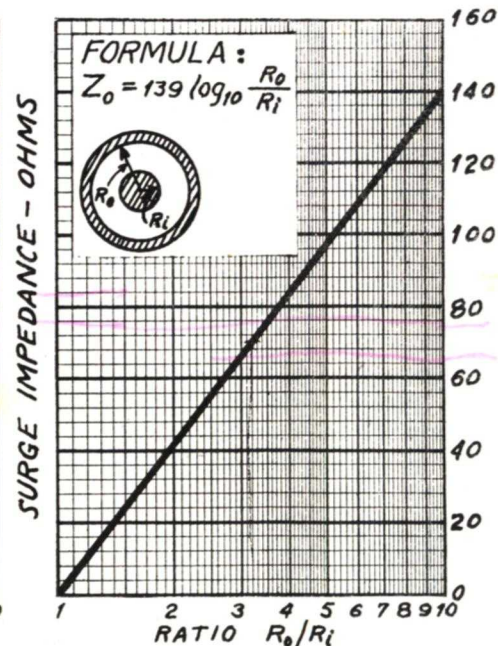

FIG. 31. Chart for determining the characteristic impedance of coaxial cable of various physical dimensions. Effective dielectric is assumed to be air.

are determined by the size of the line conductors, their spacing, and the dielectric constant of the insulation between them.

In our study of audio-frequency lines, we found that the characteristic impedance of a line varies with the signal frequency. This is not true of high-frequency lines. For audio frequencies, the resistance and leakage of a line play an important part, so that the line impedance depends, to some extent, upon the operating frequency. At radio frequencies, the inductive and capacitive reactances of the line are so much higher than the resistance effects that the surge impedance is virtually constant for all frequencies throughout the radio-frequency spectrum.

The most common r.f. lines have a surge impedance between 50 and 600 ohms. In Fig. 30 is given a chart showing the impedance for different conductor spacing of lines made of various sizes of wire and copper pipe. The formula for calculating these curves is also given. In this chart it is assumed that the effective insulation is air, which has a dielectric constant of unity.

In Fig. 31 we also have a curve and formula for determining the impedance of various sizes of coaxial cable. This cable, as you know, consists of a single conductor, insulated from, but completely enclosed by a concentric metal shield. The shield itself acts as the grounded side of the line. The surge impedance of coaxial cable is always less than that for open-wire lines. Here, too, the insulation is assumed to be air. For other insulation, such as polystyrene beads, flexible polyethylene, etc., the impedance is lower. Manufacturers of such cable usually state the impedance of their products.

Twisted-pair lines also have a surge impedance. With these, however, the

wire spacing and insulation varies so widely that it is impossible to make a comprehensive chart. This information is also supplied by the manufacturer.

MISMATCHING EFFECTS

In practical work, because of stray capacitance, resistance, and inductance of lead wires, etc., it is often impossible to realize a perfect impedance match between a transmission line and its load. In such cases, it is desirable to know how close a match is provided by a given adjustment, and also, how accurate the match must be in order to keep line losses at an acceptable value.

If a line is terminated in a resistance load that is slightly higher than the line impedance, standing waves are developed along the line. This is illustrated in Fig. 32A. In this case, however, the reflected wave is not as intense as it is for an open circuit, and as a result, the maximum values of the voltage standing wave are relatively small. The standing wave pattern, il-

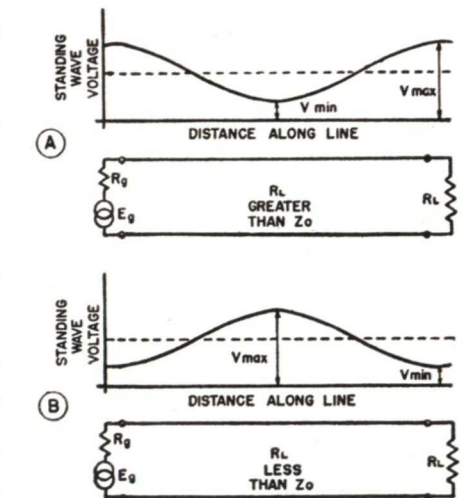

FIG. 32. The ratio of minimum to maximum voltages, hence the standing wave ratio, gives the ratio of line and load impedance mismatch. The position of the voltage maximum determines whether or not the load impedance is higher, or lower than the line impedance.

illustrated in this figure, is what can be expected for this sort of mismatch, and we consider it as the sum of a steady voltage along the line, added to a small standing wave.

Standing Wave Ratio. If we now measure, with a special high-frequency a.c. voltmeter, the various voltages

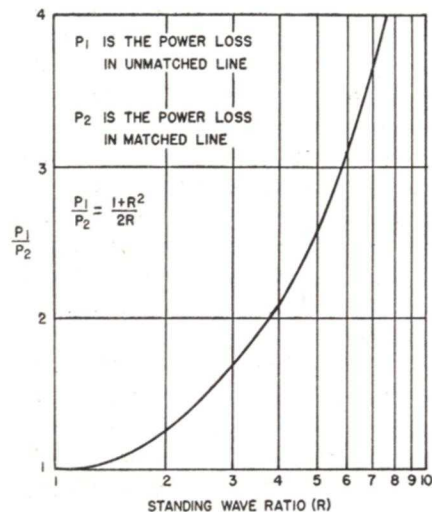

FIG. 33. The power loss in a transmission line increases as the standing wave ratio is increased.

along the line, we find a minimum voltage V_{min} , and a maximum voltage V_{max} , as indicated in Fig. 32. The ratio of the two, namely, V_{max}/V_{min} is commonly called the "voltage standing wave ratio."

► Since the voltage standing waves are a direct result of the impedance mismatch between the load and the line, we may expect a definite relationship between the standing wave ratio and the degree of mismatch. As a matter of fact, *the ratio of the line impedance Z_o to the load resistance R_L is equal to the standing wave ratio.*

In this instance where the load resistance is *higher* than the line impedance, we have the wave ratio:

$$\frac{V_{max}}{V_{min}} = \frac{R_L}{Z_o}$$

If the load resistance is *lower* than the line impedance, the voltage distribution of Fig. 32B is set up along the line. Although the positions of voltage minimum and maximum values are shifted, the ratio of these two voltage values indicates the degree of mismatch. For this case we have:

$$\frac{V_{max}}{V_{min}} = \frac{Z_o}{R_L}$$

Let us suppose that on a given transmission line, we measure a minimum standing wave voltage of $V_{min} = 5$ volts, and a maximum voltage $V_{max} = 15$ volts. The standing wave ratio is:

$$\frac{V_{max}}{V_{min}} = \frac{15}{5} = 3$$

This tells us that the load resistance R_L is either *three times as high* as the line impedance Z_o , or only *one-third as high*.

► But which of these is correct? To determine whether the load resistance is *higher* or *lower* than the line impedance, we note the *position of the voltage maximum V_{max} along the line*. If there is a *voltage maximum* at the load, the resistance R_L is *higher* than Z_o . On the other hand, if there is a *voltage minimum* at the load, as in Fig. 32B, the load resistance is *lower* than the line impedance.

The measurement of the standing wave ratio provides a reliable way of determining whether or not the load impedance is matched to a transmission line, and if a mismatch is present, it tells us the seriousness of it. This method is particularly convenient at ultra-high frequencies where the measurement of line and antenna impedances becomes exceedingly difficult.

If we find it impossible to eliminate standing waves entirely, how much standing wave ratio can be tolerated, before the line losses becomes excessive? If we plot the ratio of the power

that is lost in an unmatched line for various standing wave ratios to that lost in a perfectly matched line, we obtain a curve like that shown in Fig. 33. This loss curve shows that the impedance match need not be critical. For example, if we have a standing wave ratio of 2—which means that the load impedance is either 100% greater, or 50% smaller than the line impedance—we find that the line loss is only 25% more than that for a perfectly matched line. In actual practice, particularly at ultra-high frequencies, this is a satisfactory match.

MATCHING A TRANSFORMER TO A LINE

Now that we have learned that an untuned transmission line requires impedance matching at both the transmitter and the antenna terminations, what are some practical methods of achieving a satisfactory match at these points?

Transformer Matching. At the input end, the transmitter tank can be coupled to an untuned line by any of the methods used for resonant lines. One of the most common methods makes use of an impedance-matching transformer as shown in Fig. 34A. The number of turns on the pickup coil L_2 , or the spacing between this coil and the tank coil L_1 may be adjusted until the proper impedance is presented to the line. Usually, the coupling is increased until the transmitter final stage draws proper plate current. As it is impossible to secure perfect coupling with air-core coils, the tuning condensers C_1 and C_2 are necessary to balance out the transformer leakage inductance. These two condensers are tuned individually, until maximum currents are indicated by the ammeters in each side of the balanced line. The electrostatic shield, or Fara-

day screen, is used to prevent the flow of undesired harmonic currents into the antenna circuit by eliminating the stray capacity between the coils of the r.f. transformer.

Direct Coupling. A simpler method of coupling a push-pull tank to a line is illustrated in Fig. 34B. The two transmission-line terminals are clipped on the transmitter tank; one on each side of the ground, or zero potential point. The more tank coil turns between the connections, the tighter is the coupling, and the higher is the impedance presented to the transmission line. For one particular setting of the terminal clips, the transmitter stage draws proper input power, and the transmission line is matched. This sys-

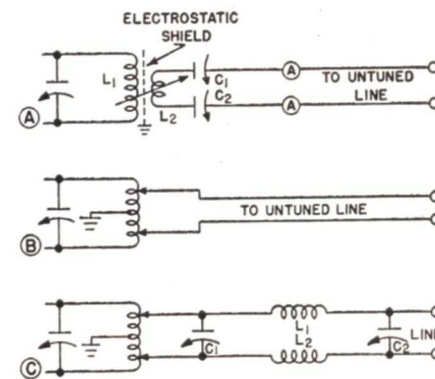

FIG. 34. Three common methods of coupling an untuned transmission line to the transmitter tank; A transformer coupling, B direct coupling, C use of the pi-coupler impedance-matching network.

tem, however, does not discriminate against the radiation of spurious harmonics.

Pi Section Coupling. A more complex, but very efficient method of coupling, is shown in Fig. 34C. This is known as a "pi-section coupler." The network is a low-pass filter section, adjusted to a quarter wavelength long; and the pi coupler, like a quarter-wave line, has the property of inverting the

impedance attached to its output terminals. Thus, if a low-impedance line is connected to the right-hand terminals, the impedance presented to the transmitter tank at the left is quite high.

In use, the capacity C_2 is set at some arbitrary value, and the condenser C_1 is adjusted to restore the transmitter tank to resonance. If the power absorbed from the transmitter is not sufficient for this adjustment, then the capacity C_2 is *decreased*, and the condenser C_1 is again tuned for transmitter-tank resonance.

Since the pi coupler is a true low-pass filter, it is extremely effective in preventing undesirable harmonic radiation.

E, I, AND P IN UNTUNED TRANSMISSION LINES

In actual practice, it is often necessary to calculate the amount of current and voltage in an untuned r.f. transmission line that is carrying a definite amount of power. Peak voltage is par-

$$\begin{aligned} E_{r.m.s.} &= \sqrt{PR} \\ E_{r.m.s.} &= \sqrt{50,000 \times 500} \\ &= \sqrt{25,000,000} \\ E_{r.m.s.} &= 5000 \text{ volts.} \end{aligned}$$

Since the impedance of the line is 500 ohms,

$$I = \frac{E}{R} = \frac{5000}{500} = 10 \text{ amperes.}$$

To find the maximum voltage between the two conductors, however, we must know the *peak* voltage. Since the *peak* voltage is $\sqrt{2}$ (approximately 1.4) times the r.m.s. value we find that:

$$\begin{aligned} E_{\text{peak}} &= 1.4 E_{r.m.s.} \\ E_{\text{peak}} &= 1.4 \times 5000 \text{ volts.} \\ E_{\text{peak}} &= 7000 \text{ volts.} \end{aligned}$$

We see, therefore, that the peak voltage, between the two conductors of a transmission line, can become quite high when large amounts of power are being transmitted in an r.f. line. From these simple calculations, we notice that the peak voltage in a transmission line depends on the power, and Z_0 . For a line with a definite Z_0 , its power rating becomes an essential factor in its use, for the power rating is limited by the current and peak voltage that can be handled by that line.

For this reason then, in concentric lines, the dielectric frequently used is dry nitrogen gas under a few pounds of pressure. The break-down voltage of this gas is higher than that for air, and thus the line can be made to carry more power.

MATCHING A LINE TO AN ANTENNA

At the antenna end of a transmission line, where it is important to secure a reasonable impedance match to prevent excessive standing waves, many methods of coupling have been devised. Some of these were discussed

in an earlier Lesson on elementary antennas. It is possible, as shown in Fig. 35A, for instance, to couple a 73-ohm untuned line directly into the center of a doublet or dipole that also has a radiation resistance of approximately 73 ohms.

For higher impedance lines, the delta match in Fig. 35B can be used. In this arrangement, the end of the 600-ohm line is "fanned out" so that the line can

$$Z_1 = Z_0^2 / Z_2$$

or we can rearrange this equation to read:

$$Z_0 = \sqrt{Z_1 Z_2}$$

Let us suppose that we match a 600-ohm line to a 73-ohm antenna, as shown in Fig. 36. This gives us the values:

$$\begin{aligned} Z_1 &= 600 \\ Z_2 &= 73 \end{aligned}$$

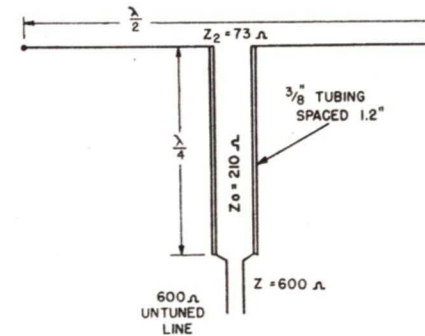

FIG. 36. The "Q" antenna uses a resonant quarter-wave section as an impedance-matching transformer.

be attached to the proper higher impedance points (600 ohms) of the half-wave antenna. By gradually spreading the line in this manner, the line impedance has no *abrupt* change, and the standing waves are thus prevented.

Quarter-Wave Sections. In Fig. 36, we have an ingenious method of matching a high-impedance line to the low impedance of an antenna that makes use of a resonant quarter-wave section as a matching transformer. We have already learned that for a resonant quarter-wave line, the impedance at one end is inversely proportional to the impedance at the other end. In a more exact statement, the impedance Z_1 for one end of the quarter-wave section is equal to the square of the characteristic impedance Z_0 of the line divided by the impedance Z_2 at the opposite end. This is written:

If we put these values into our equation, we obtain for Z_0 :

$$\begin{aligned} Z_0 &= \sqrt{Z_1 Z_2} = \sqrt{600 \times 73} \\ &= \sqrt{43,800} = 210 \text{ ohms} \end{aligned}$$

which indicates that in order to match the 600-ohm untuned line to the 73-ohm antenna we place between the two a quarter-wave resonant section that has a characteristic impedance Z_0 of 210 ohms. In the chart shown in Fig. 30, we find that a line made up of $\frac{3}{8}$ inch pipes spaced 1.1 inches between centers has the desired 210-ohm characteristic impedance. This gives us the quarter-wave transformer design shown in Fig. 36. Antennas using this particular method of impedance matching are commonly called "Q" antennas.

Quarter-wave resonant sections are also used as "matching stubs" to pro-

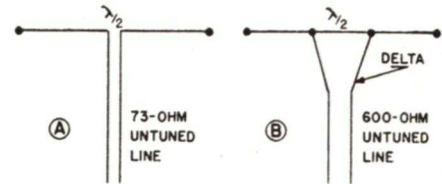

FIG. 35. In A, a 73-ohm untuned line can be attached directly to the center of a half-wave doublet. In B, by spreading the end of a 600-ohm line, the resulting delta can be made to provide a satisfactory impedance match.

ticularly important, for it determines the amount of insulation necessary in a line.

For example, let us calculate $E_{r.m.s.}$, I , and E_{peak} in a 500-ohm line that is used for coupling 50,000 watts of unmodulated r.f. power from a transmitter to an antenna. From Ohm's Law, we have:

vide impedance matching between an untuned line and the antenna. In such applications, the characteristic impedance of the sections is unimportant.

In Fig. 37A, for instance, is a current-feed system, where a matching quarter-wave open stub is attached to the center of a half-wave antenna. As the antenna impedance is quite low, the lower end of the stub assumes a high impedance. Consequently, somewhere along the stub there is a 600-

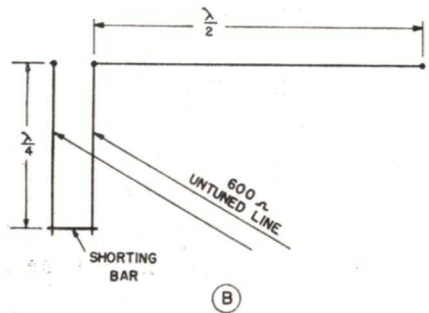
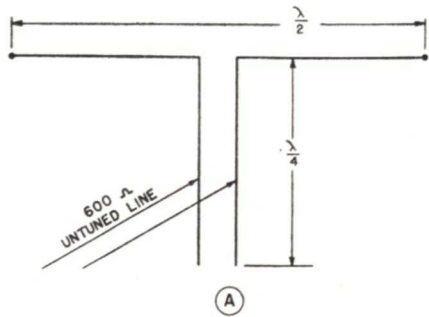

FIG. 37. Above, a current-feed system using an open quarter-wave stub for matching the 600-ohm line to the low-impedance antenna. Below, in a voltage-feed system the shorted quarter-wave stub transforms the 600-ohm line impedance to a very high value to match the impedance of the end-fed antenna.

ohm impedance point that accurately matches the 600-ohm untuned line.

In adjusting such a matching stub, the untuned line is attached at different points opposite to each other, up and down the stub, until the point is found which results in a minimum of

standing waves along the feeder line. In some cases, because of stray inductance or capacitance effects, it may be necessary to adjust the length of the stub by lengthening, or trimming slightly, to obtain the best results.

A voltage-feed stub-matching system is shown in Fig. 37B. In this instance, the lower end of the stub is shorted so that the upper end of the stub assumes a high impedance to match that of the antenna. Somewhere along the length of the stub there is found a 600-ohm impedance point. The adjustment of this stub is similar to the adjustment made in the current-fed system. The feeder wires are slid along the stub until a minimum standing wave is obtained along the untuned line. Here, too, the stub may need a slight readjustment that is accomplished by varying the position of the shorting bar.

Measuring the Standing Waves.

As we have stated before, when an antenna is accurately matched to an untuned transmission line, the standing wave ratio of the line and thus the line losses are reduced to a minimum. (A standing wave ratio of 1.5 is acceptable in most practical work.) The most convenient method of checking the performance of a transmission line, therefore, is to measure the standing wave ratio. Indeed, it is almost impossible to adjust some of the stub-matching systems without some means of determining the standing wave ratio for each adjustment of stub length and feeder line connection.

For open wire lines, the presence of standing waves can be checked by using a neon tube shorting bar, as shown in Fig. 38A. When this is slid along the line, if there are no standing waves, the tube glows with the same brilliance at all points. With standing waves present, however, the tube glows

brightly at the voltage loops, and dims perceptibly at the voltage nodes.

For higher power installations it is not necessary to make a direct connection between the shorting bar and the

the standing wave ratio directly. Care should be taken, however, to prevent excessive current from flowing through the meter, and damaging it. This can be done by reducing the transmitter

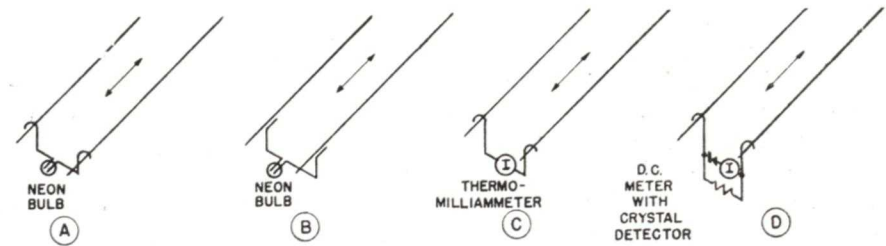

FIG. 38. By sliding a neon tube shorting bar along an open-wire line, as in A and B, the presence or absence of standing waves can be determined. If a thermo-ammeter as shown in C, or a d.c. milliammeter with a crystal rectifier as in D is used, the standing wave ratio can be measured accurately.

line. Instead, as indicated in Fig. 38B, a small capacity, such as when an insulated wire is hooked over the line, provides enough current to light the neon tube.

The use of a neon bulb allows only a rough check, and the standing wave ratio cannot be measured by this means. For more accurate work, an r.f. thermo-milliammeter, such as shown in Fig. 38C, can be used to measure

power, or by keeping the capacity of the shorting bar leads low.

If a thermal instrument is not available, equally accurate readings can be taken with a vacuum-tube diode, or crystal rectifier in series with a d.c. milliammeter. This arrangement is shown in Fig. 38D. With this method, too, excessive current should not be allowed to flow, or the rectifier and the meter may be ruined.

Cause and Prevention of Line Radiation

Since a radio-frequency current flows along them, transmission lines that are not shielded may have some stray radiation, in spite of the fact that the radiation field from one side of a line is equal, and opposite to that from the other. These two fields do not completely cancel and result in zero stray radiation unless the two sides of the line have no physical separation between them. But this is impossible.

RADIATION FROM LINES

Stray radiation from a line is proportional to the separation of the conductors. As a general rule, the radiation from tuned and untuned lines is about equal for the same average current and identical conductor spacing. With resonant lines, however, the high voltage at the standing wave voltage loops makes considerable conductor spacing necessary in order to prevent voltage breakdown. On the other hand, untuned lines that have no standing waves, can handle the same power with much less conductor spacing. It is for this reason alone that the practical untuned lines can usually be made with less stray radiation losses.

The Single-Wire Transmission Line. To illustrate that the presence or absence of standing waves has little to do with line radiation, let us consider the "single-wire" untuned transmission line shown in Fig. 39. With this method of feeding an antenna, a single wire, having a characteristic impedance of approximately 600 ohms, is attached about $1/14$ of a wavelength from the center of the half-wave doublet. By sliding the connection back and forth, the exact point can be found where the antenna impedance is also 600 ohms. For this condition, no stand-

ing waves are developed along the feeder line.

The other side of this transmission line is effectively the *image* of the feeder resulting from the reflection of radiation from the ground. As a consequence, the two sides of such a transmission line are far apart, and the stray radiation is high in spite of the fact that there are no standing waves along the feeder length. Because of these excessive stray radiation losses, this type of antenna feed is seldom used except in amateur, portable, or emergency equipment.

The Open-Wire Line. The next best type of transmission line, from a stray-radiation viewpoint, is the open-wire, or parallel-wire line. Because it is very easily insulated, this type of line is almost universally used for tuned, or resonant feeders.

Stray radiation can be reduced somewhat, if the conductors are crossed or "transposed," so that the position of the wires is interchanged every few feet along the transmission line. This also equalizes the capacity of each side of the line to ground, a necessary condition for proper balanced-line operation.

Nevertheless, since the conductors are usually spaced somewhere between 2 and 6 inches, the stray radiation from open-wire lines can become excessive, particularly at ultra-high frequencies.

The Twisted-Pair. The radiation loss from a twisted-pair line is ordinarily very low, because the conductors are very close together, and they are "transposed" with every twist.

It is very difficult, however, to maintain adequate insulation between the wires for high-power operation, and where the line is exposed to the

weather, the leakage resistance often becomes intolerable.

Twisted-pair lines are not often used, except for receiving antennas, and low-power transmitter installations.

The Shielded Pair. The radiation loss of any transmission line, can be reduced to zero by adequate line shielding. Thus, if we reduce the separation of an open-wire line until it can be enclosed in a flexible, braided metal shield, the radiation loss is eliminated.

Unfortunately, the nearness of the conductors limits the amount of power such a line can handle, because of the danger of voltage breakdown. To make matters worse, the intense electric field between the conductors, leads to excessive dielectric losses at all except the lowest radio frequencies.

The Concentric Line. By far the most satisfactory type of transmission line is made by using concentric, or coaxial, cable. As described before, this cable consists of a single conductor, completely enclosed in a concentric shield. The inner conductor is insulated from the shield, and the shield itself serves as the second, or "ground," side of the line. With this method of construction, the maximum amount of conductor separation in a shielded line is realized. In addition, the outer shield can be suitably waterproofed so that the operation of the line is not affected by adverse weather conditions.

Although concentric cable should not be used for *tuned* lines, because of possible voltage breakdown, it does represent the best practical method of constructing a completely shielded *untuned* transmission line. At ultra-high frequencies, where it is imperative that lines be shielded to prevent excessive radiation, the coaxial line is the only satisfactory line that can be used. Because of the increasing importance of

these ultra-high frequencies, a more detailed discussion of the use of coaxial cable is merited.

CONSTRUCTION AND USE OF COAXIAL CABLE

In general, any rigid or flexible metal pipe that has an insulated conductor extending through it, may be called a coaxial cable. We find that cables of various types differ principally in the size and material of the shield and conductor, the choice of the dielectric that

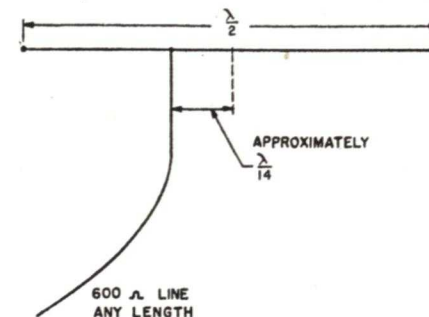

FIG. 39. The single-wire transmission line feeding a half-wave antenna. Although this system can be adjusted so that no standing waves are present on the line, the stray radiation from the line, ordinarily, is quite high.

is used for insulation, and the manner in which these are put together.

Construction. One of the first types of coaxial lines was made by running a bare copper wire down the center of a metal pipe. The wire was supported and insulated from the outer pipe shield by mica, polystyrene, or glass washers spaced evenly along the length of the line. A cross-sectional view of such a "spaced-separator" line is given in Fig. 40A.

Since most of the effective insulation is air, the velocity of radio energy along this line is very nearly the same as it is in free space. Line characteristic impedance is determined by the physical size of the wire and pipe with air as a dielectric. The chart shown in Fig. 31 is for lines of this kind.

Although quite efficient at moderately high frequencies, there are critical frequencies above which the spaced-separator coaxial line does not perform properly. When the operating frequency is increased to the point where the spacing between the supports becomes about a quarter-wavelength long, the discreet change of line impedance at the separators leads to development of standing waves. The behavior of the line, therefore, suddenly becomes erratic, and its losses may sharply increase. This characteristic, together with the inconvenience of using a non-flexible pipe, has led to discontinuance of its use.

The first flexible coaxial cable was made by enclosing a braided wire in glass, or polystyrene beads, then covering these with a flexible, braided shield. As shown in Fig. 40B, the beads, being concave at one end, and convex at the other, can twist with respect to each other, so that some degree of flexibility is built into the cable. Also, since the inner conductor is completely enclosed by the dielectric, the standing wave trouble is eliminated.

The flexibility of beaded cable, how-

ever, is not great, and very often sharp bends in the cable result in a broken or frayed inner conductor. Because better cable has been developed, beaded cable, also, has fallen into disuse.

With the development of flexible plastics that have low dielectric loss at ultra-high frequencies, it is possible to construct a solid-dielectric flexible coaxial cable. Several insulating materials may be used, but the most common is polyethylene. The stranded inner conductor is molded into the plastic, as shown in Fig. 40C; the braided, flexible shield is placed directly over the plastic, and finally, the outer waterproof covering is added.

This simple method of construction gives a flexible but rugged cable that performs well over a large part of the frequency spectrum. For moderately long lines, this cable has small losses up to ultra-high frequencies of about 2000-5000 megacycles. Even for frequencies as high as 10,000 megacycles, it may be used in relatively short lengths.

At the super-high frequencies above 10,000 megacycles, the losses in a poly-

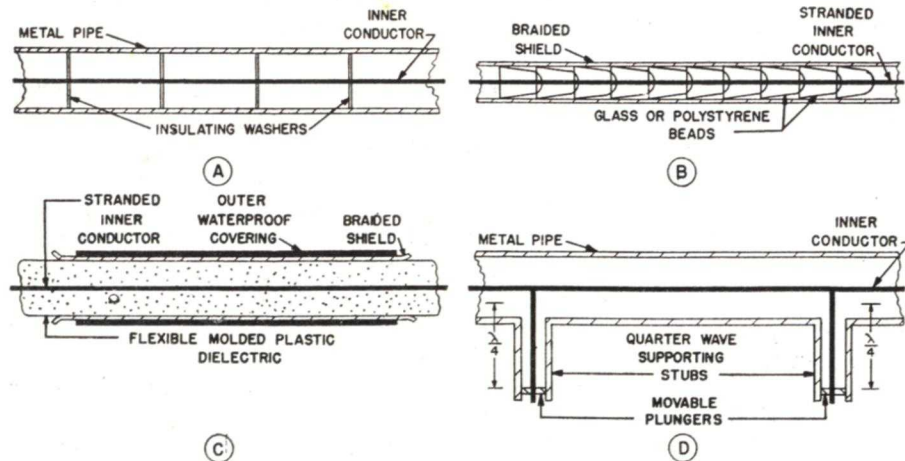

FIG. 40. Four methods of constructing coaxial cable: A the spaced-separator cable, B the flexible beaded line, C solid dielectric flexible cable, D the stub-supported concentric line.

ethylene cable become excessive. It becomes necessary then to return to the best dielectric known, that is, air. For these extreme frequencies, coaxial lines are usually constructed by enclosing a bare copper wire, or small pipe in a larger pipe, as pictured in Fig. 40D. This resembles the spaced-separator line in every way, except that insulating washers are not used; instead, the inner conductor is supported by quarter-wave stubs. Each of these stubs, as indicated, is adjusted by moving the metal plunger in the stub pipe until the effective electrical length is one-quarter wave at the operating frequency. Since these stubs are shorted at the bottom, a very high impedance is presented to the inner conductor of the coaxial line. Such stubs are very effective insulators, and are often called "metal insulators."

This type of line is not flexible, and it cannot be used except at the one frequency for which the supporting stubs are resonant. Nevertheless, this is the most efficient type of line that has been devised for these extremely high frequencies.

How Coaxial Lines Are Used. A coaxial line is not a balanced line, because the outer shield is grounded. However, it is possible to feed a balanced load with an unbalanced coaxial cable by using special matching methods.

Suppose, for instance, that we feed a 73-ohm dipole with a 73-ohm coaxial line. An attempt to do this, in the manner shown in Fig. 41A, shows that the left half of the antenna cannot assume its proper potential, and r.f. current tends to flow down the grounded cable shield.

This trouble can be avoided if the upper end of the cable is enclosed in a metal cylinder one-quarter wave long. This is illustrated in Fig. 41B.

The lower end of the cylinder is connected directly to the coaxial cable shield, and the upper end is left free. This is equivalent to a quarter-wave

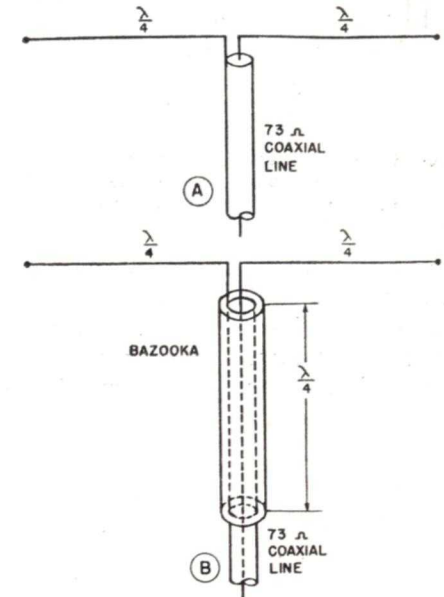

FIG. 41. The arrangement in A cannot be used because r.f. current tends to flow down the grounded cable shield. The quarter-wave choke, or "bazooka," in B, prevents the r.f. grounding of one side of the antenna.

supporting stub, since the lower end is shorted, and the upper end, near the antenna, has a high impedance. With this arrangement, the upper end of the cable, and the section of antenna connected to it, as well as the half of the antenna that is connected to the center conductor is "hot," (at an r.f. potential). Thus both halves of the antenna radiate properly even though the remainder of the outside conductor of the feeder line remains at ground potential. This impedance-matching quarter-wave section is sometimes called a "quarter-wave choke," or more commonly, a "bazooka."

In a somewhat similar manner it is possible to match a 50-ohm coaxial line to a balanced 200-ohm load. This is

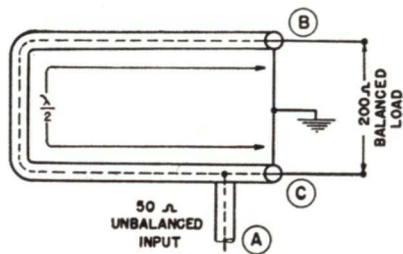

FIG. 42. Method of matching an unbalanced 50-ohm coaxial cable to a balanced 200-ohm load by means of a half-wave cable loop.

done, as pictured in Fig. 42, by folding back a portion of the line, so that the U-shaped section is a half-wave long, and making the connections to the load as shown. As the impedance

conditions at each end of a half-wave line are identical, each side of the balanced line has an impedance of 50 ohms to ground, or an over-all impedance of 200 ohms.* Also, as the voltage, or current, at each end of the half-wave section is 180° out of phase, the balanced load is driven in true push-pull fashion.

*Notice that the voltage across each of the two outputs B and C is equal to the input voltage at A. The voltage across the balanced load output, therefore, is double the input voltage. Assuming no losses, the output power is equal to the input power, so that the current in the output must be one-half the current in the input. The impedance of the output circuit, therefore, is 4 times (2 divided by 1/2) the input impedance. In this case, the 50-ohm input is matched to a 200-ohm output.

Lesson Questions

Be sure to number your Answer Sheet 24RC.

Place your Student Number on every Answer Sheet.

Most students want to know their grade as soon as possible, so they mail their set of answers immediately. Others, knowing they will finish the next Lesson within a few days, send in two sets of answers at a time. Either practice is acceptable to us. However, don't hold your answers too long; you may lose them. Don't hold answers to send in more than two sets at a time or you may run out of Lessons before new ones can reach you.

1. What is a "brute-force" filter?
2. Give three reasons why half-section filters are used at the input and output of complex filters.
3. What is the apparent resistance at the input of a half-wave line that is terminated in a 1000-ohm resistor?
4. If a quarter-wave line, having no losses, is terminated in a short circuit, what is the value of the input impedance?
5. What are the necessary requirements for operating a transmission line efficiently, and without standing waves on the line?
6. Draw, in schematic form, a tuned output circuit of a transmitter, one that is balanced to ground, and coupled to a balanced transmission line through a pi coupler.
7. What is the purpose of the electrostatic shield that is usually found between the output tank coil of a transmitter, and the pickup coil that connects the transmitter to the transmission line?
8. If 10,000 watts of unmodulated r.f. power is being coupled through a 100-ohm untuned transmission line, what is the peak voltage between the two conductors of the line?
9. What length of tuned line would be used to match a low-impedance antenna to a high-impedance line?
10. How do you know, by measuring the standing wave ratio of a line, when the antenna is best matched to the transmission line?

HONESTY

That old proverb, "*Honesty is the best policy,*" is just as true today as ever. Any firm that depends upon repeat business cannot exist for long without following this policy; any man who deals with other people cannot afford to disregard it.

Strict observance of the law keeps a man out of jail, but that does not necessarily make him an honest man. Honesty goes far beyond the law; it involves a careful regard for the rights of others, a truthfulness and sincerity in dealing with others, and a fairness and trustworthiness in matters involving property or business.

It is not enough to act so that others think that you are honest; you yourself must know that you are playing the game fair and square, if you are to enjoy that real satisfaction associated with absolute honesty.

Be honest, and your reputation will take care of itself. Let your spoken word, your slightest implied action be as good as your signature on a legal contract, and you will enjoy those things that no amount of money can buy—happiness, success, and the respect of your fellow men.

J. E. SMITH