

**TV INTERFERENCE ELIMINATION  
AND  
SPECIAL TV INSTALLATIONS**

*Finish*

62RH-2

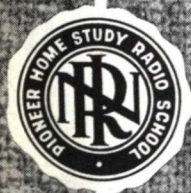

**NATIONAL RADIO INSTITUTE**

**WASHINGTON, D. C.**

**ESTABLISHED 1914**

# STUDY SCHEDULE NO. 62RH-2

For each study step, read the assigned pages first at your usual speed, then reread slowly one or more times. Finish with one quick reading to fix the important facts firmly in your mind. Study each other step in this same way.

1. **Introduction** . . . . . Pages 1-6

In this first section, you learn additional facts about eliminating ghosts and about the use of boosters.

2. **Interference Traps** . . . . . Pages 6-12

The use and construction of stubs and traps to reduce interference are described in this section.

3. **Eliminating R.F. Interference** . . . . . Pages 12-25

Here you learn what the various sources of r.f. interference are and how they can be eliminated.

4. **Special TV Installations** . . . . . Pages 26-36

The solutions to the problems met in four special kinds of TV installations are described in this section.

5. **Answer Lesson Questions, and Mail your Answers to NRI.**

6. **Start Studying the Next Lesson.**



## TV INTERFERENCE AND SPECIAL INSTALLATIONS

CONVENTIONAL TV receiver installations have been discussed in previous Lessons. The instructions given in those Lessons cover most of the problems you will meet. However, you may run into some special problems—heavy and constant interference, for example—that make an installation particularly difficult. This Lesson will show you what to do when you meet these unusual conditions.

First, let's take up the problem of eliminating ghosts.

### GHOSTS

You have already learned that ghosts may be caused when a signal reaches the antenna over two or more paths or when the receiver and the transmission line are not matched in impedance. Ghosts of the first sort can often be eliminated by orienting the antenna so that it does not pick up the reflected signals; and those of the second kind can be gotten rid of by matching the line impedance to that of the receiver.

There are, however, some conditions under which orienting the antenna will not eliminate the ghosts completely. One of these occurs when the object that reflects signals to the antenna is close behind the antenna. In this case, it may well be that the reflected signal is so strong that even a very directive array cannot ignore it completely. You have probably noticed that the antenna radiation patterns shown in earlier Lessons always have at least a small back lobe. The presence of this lobe indicates that the antenna picks up from its rear to some extent. If the signal coming from the backward direction is very strong, therefore, it will be picked up by the antenna sufficiently well to cause a ghost.

The remedy for this condition is to use a large reflector to shield the antenna from the undesired signal. A large screen of chicken wire will often serve the purpose. Of course, you should not go to the trouble of erecting such a screen unless it is absolutely necessary to do so.

A ghost that is very difficult if not impossible to eliminate is caused when the reflected signal comes from almost the same direction as the direct signal. An example of the conditions that can cause such a ghost is shown in Fig. 1. Here there may be as many as six

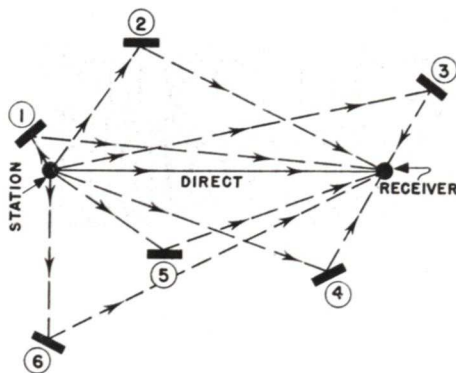

FIG. 1. A set in the location shown may receive as many as 6 reflected signals in addition to the direct signal, making it possible for there to be 6 ghosts.

ghosts caused by reflections from six different structures.

If we use a directive antenna and point it for maximum pickup from the TV station, the chances are that the signals bouncing off the buildings marked 3 and 4 will be eliminated. We may even be able to eliminate the signals reflected from the buildings marked 2 and 6. However, we will not be able to eliminate the reflection from the buildings marked 1 and 5, because the reflected signals come from practically the same direction as the transmitted signal.

The only hope of getting ghost-free reception in a location of this sort lies in using a highly directive antenna array and aiming it so that it will pick up one of the reflected signals and nothing else. In the situation shown in

Fig. 1, it might be possible to prevent ghosts by aiming the array at building 3. If the array were highly directive, you could probably eliminate pick-up of all other signals—including the direct one—by doing so.

A ghost may be either a “positive” or a “negative” ghost. A negative ghost is reversed with respect to the original image. In other words, the black portions are white, and the white portions are black. Whether a ghost is positive or negative depends upon the phase relationship of the direct and reflected signals, which, in turn, depends upon the relative lengths of the direct and reflected paths. Changing these path lengths by moving the antenna will make the ghost change from positive to negative or vice versa. The usual type of ghost is called a “trailing” ghost because it appears on

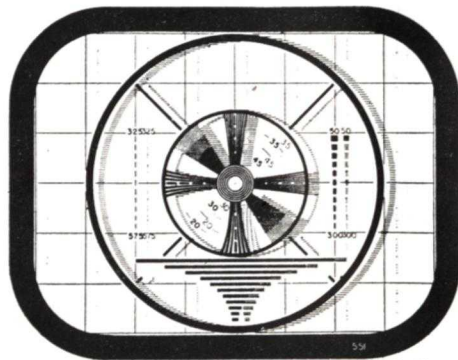

Courtesy Belmont Radio Corp.

FIG. 2. An example of a single trailing ghost.

the right-hand side of the picture (see Fig. 2). The ghost appears on the right side because the reflected signal travels a longer path than the direct signal and therefore arrives at the set later than the direct signal. Under certain conditions, however, one or more of the images may appear on the

left-hand side of the main picture, producing what is called a “leading” ghost.

This type of ghost may appear in locations where conditions like those shown in Fig. 3 exist. The location is comparatively close to the trans-

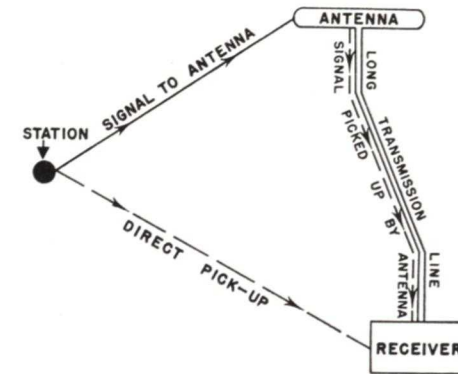

FIG. 3. Under the conditions shown here, a leading ghost may be produced.

mitter; as a result, it is possible to pick up a fairly strong signal in the r.f. or first detector circuit of the receiver even with the antenna disconnected. This direct pickup in the front end of the set may produce a ghost to the left of the main picture because the path from the TV station directly to the front end of the receiver is shorter than the path from the TV station to the antenna and down the transmission line. If the transmission line is less than 100 feet long, the direct signal may not produce a separate image but may instead blend with the antenna signal to create a picture of poor quality.

The remedy for such a condition is: (a) to reduce the direct signal pickup in the receiver by shielding the r.f. and detector circuits or by shielding the entire chassis; or (b) to increase the signal from the antenna. Of the

two, reducing the direct signal pickup in the receiver is the more effective, because usually in a location close to the transmitter the signal picked up by the antenna is already extremely high.

In many cases where direct signal pickup by a receiver causes a leading ghost, the picture will vary in quality when people move around the room near the receiver. Movement close to an unshielded transmission line may also alter the picture quality, particularly if the input impedance of the receiver does not match the impedance of the transmission line.

Another situation that can produce a leading ghost is shown in Fig. 4. In this case, the strength of the direct signal from the transmitter is greatly reduced by the intervening object. For this reason, the reflected signal reaching the receiver is stronger than the direct signal and therefore pro-

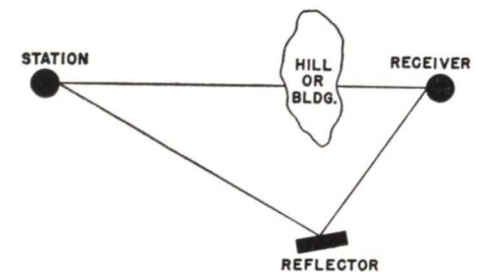

FIG. 4. Here, a leading ghost is produced because the reflected signal is much stronger than the direct signal, although the latter reaches the set first.

duces the main picture. However, since the direct signal route is the shorter of the two, the direct signal will arrive before the reflected signal and produce a leading ghost.

To eliminate this undesirable effect, the direct signal pickup must be eliminated. This can be done by using a

directive antenna and orienting it properly.

In one actual case where leading ghosts were encountered, more than 10 distinct images were seen on the picture tube with the antenna connected to the receiver and the controls adjusted properly. Disconnecting the antenna without changing the setting of the contrast control reduced the number of images. This indicated that the antenna was contributing little and that the pickup was mostly in the r.f. and detector circuits—the numerous images probably being due to signals reflected from buildings or other objects in the vicinity.

In this particular case, shielding the r.f. and detector circuits did not help. Further experimentation indicated that there was a defect in the r.f. stage of the receiver that had reduced its gain very considerably; as a result, the signal picked up by the antenna was not being amplified very much, so the antenna was contributing very little to the picture. When the defect in the r.f. stage was corrected, it was found that the signal picked up by the antenna was so much stronger than the reflected signals that the ghosts were no longer noticeable.

Thus, it is not always wise to blame a ghost on the location or on the orientation of the antenna. Unusually heavy ghosting may be caused by a receiver defect.

If you find “tunable” ghosts—ghosts that vary in number and in intensity as the tuning control of the set is adjusted—you can be sure that the receiver itself is to blame. These ghosts may be caused by incorrect alignment of the i.f. amplifier or by regeneration.

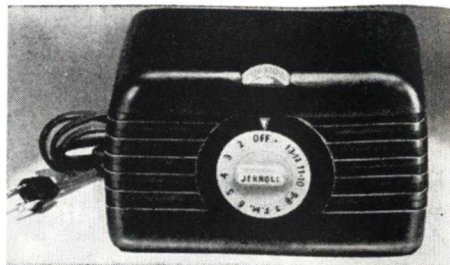

Courtesy Jerrold Electronics Corp.

The Jerrold booster, shown in schematic form in Fig. 5.

## BOOSTERS

In this and earlier discussions of the various methods of eliminating ghosts, we have pointed out that frequently ghosts can be eliminated only by using a highly directive antenna and pointing the antenna to pick up one of the reflected signals rather than a direct signal. Almost always such a reflected signal will be weak. If so, the signal can generally be brought up to usable strength by using a booster. The schematic diagram of a typical booster is shown in Fig. 5.

A booster is nothing more than a broad-band r.f. amplifier, much like the r.f. amplifier used in the front end of the television receiver. In fact, it is used as an extra r.f. stage ahead of the one in the receiver: the transmission line is connected to its input terminals and the receiver to its output terminals. It may give more than one extra stage of r.f. amplification: although many booster amplifiers, like the one illustrated in Fig. 5, use only one tube, others use two or more.

Some boosters have a continuous fine-tuning control that permits the device to be tuned over an entire TV band, with a switch being provided to change from one band to the other.

The tuning control usually consists of a variable condenser that is shunted across the coil for the particular band.

Other types of boosters, like the one shown in Fig. 5, are switched from one channel to another in the range from 2 through 7 and from one group of channels to another group above channel 7. Each channel (or group of channels) is individually tuned, the tuning arrangement being quite similar to those used for tuning the front end of a TV set.

There is enough variation between different brands of boosters to make it worth your while to be careful in selecting one. Some of the first booster amplifiers manufactured and some of those on the market at the

present time do not give a gain in signal strength on all of the channels. On some channels an actual loss of signal strength might occur.

Of course, the fact that a certain booster does not give a gain on all channels may not be any disadvantage. If it gives a gain on all the channels that can be picked up where the installation is made, the fact that it may cause a loss on some other channel is unimportant (unless, of course, that channel is slated to go on the air in your location in the future).

To make sure that a booster will be suitable for a particular installation, get specific data from the manufacturer or the distributor of the amplifier concerning its gain on each chan-

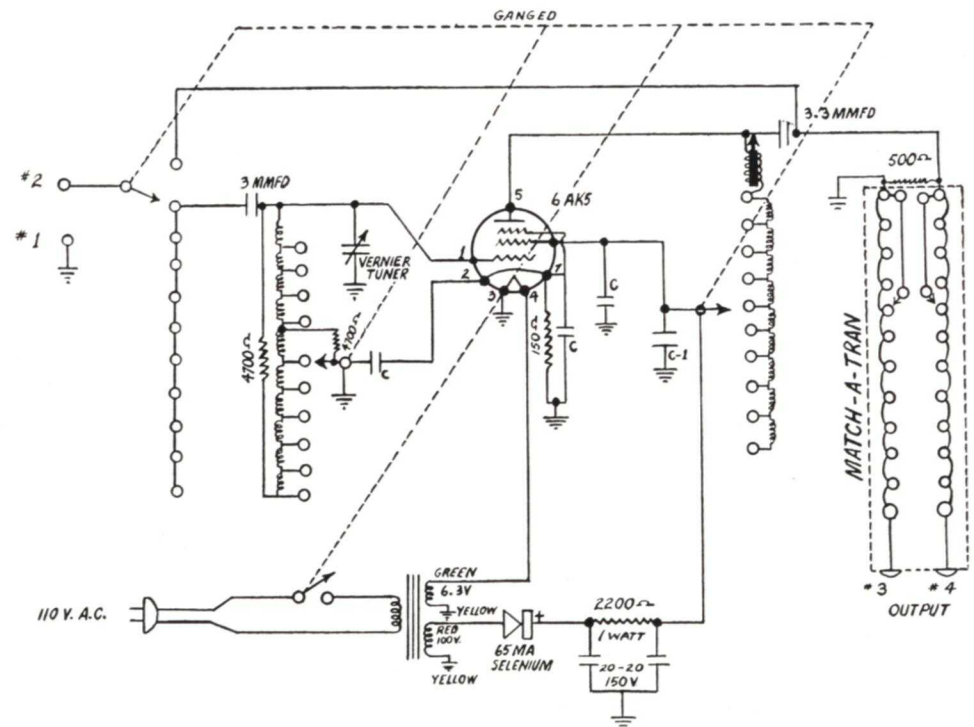

Courtesy Jerrold Electronics Corp.

FIG. 5. The schematic diagram of a typical all-channel booster. It is essentially a broad-band, single-stage r.f. amplifier.

nel. Be sure that the booster will actually give a gain on all the available channels.

A booster is most commonly used in fringe-area installations where the signal strength is comparatively low. In these installations, two boosters are often used. When this is done, the transmission line from the antenna is connected to one booster, the output of that booster is connected to the input of the second booster, and the output of the second booster is connected to the receiver. If a gain of 5 or 6 can be realized from each booster, the total gain of the two boosters in cascade will be between 25 and 30. Such a gain, of course, will often produce a very great improvement in the picture quality.

There are many other uses for a booster. Sometimes one is used with an indoor antenna. In fact, indoor antennas combined with booster amplifiers are commercially available. In some locations, the use of an indoor

antenna and a booster amplifier will make an outdoor antenna unnecessary.

A booster amplifier is sometimes used, not to increase the signal strength, but to prevent feedback from the TV receiver to the antenna. A signal from the local oscillator in the TV receiver may be feeding back to the antenna, radiating, and causing interference with other sets. Under such conditions, a booster amplifier may be installed in series between the antenna and TV set to isolate the local oscillator of the TV receiver from the antenna and thus to eliminate this radiation and reduce interference with other people's sets. One may also be used to increase the selectivity of the TV receiver when it is necessary to eliminate interference from services operating on frequencies near the TV channels. Image interference may also be eliminated or greatly reduced by the use of a booster. These uses of the booster will be discussed in more detail later.

## Interference Traps

To use "effect-to-cause" reasoning when you are working on a TV set, you must be familiar with how the picture is formed and be able to recognize what will cause certain distinctive changes or patterns in the picture. When interference is the problem, a careful examination of the picture—particularly a test pattern—will often furnish excellent clues to the cause of the interference.

With the TV set operating normally and with no station being received, a

raster should appear on the screen when the brightness control is advanced. This raster consists of many very fine horizontal lines and several vertical retrace lines. The latter slope diagonally upward from left to right.

As you will remember, a scanned field consists of 262.5 lines. The entire group of lines is repeated at a frequency of 60 cycles per second. Thus, the frequency of the sweep producing the horizontal deflection is  $60 \times 262.5$  or 15,750 cycles per second, and the

frequency of the sweep producing the vertical deflection is 60 cycles per second.

If an a.c. signal is introduced in the grid circuit of the picture tube, the brightness of parts of the raster will be varied in accordance with the signal. As the grid is made more positive with respect to the cathode, parts of the raster will become brighter; as it is made less positive, other parts of the raster will become darker. If the a.c. signal is of a fixed frequency, the pattern produced will depend, to a large extent, upon the signal frequency and amplitude. If the amplitude is sufficient to drive the grid of the picture tube very far negative, part of the raster will be darkened.

If the frequency of the a.c. signal applied to the grid circuit of the picture tube is less than the frequency of the sweep producing the horizontal lines, several adjacent lines may be blacked out at one time; as a result, horizontal bars will be produced across the face of the picture tube, as shown in Fig. 6.

Therefore, any defect or interference that causes horizontal bars on the screen is occurring at a frequency of less than 15,750 cycles per second. A rough indication of the frequency of the interfering signal can be obtained from the number of bars seen. If only one large bar is seen, for example, the frequency must be the same as that for a field—in other words, 60 cycles per second. If two complete bars are produced, the frequency producing them is 120 cycles per second.

Thus, if you find an interference pattern similar to the one shown in Fig. 6, you can be sure that the interfering signal applied to the grid of

the picture tube has a frequency falling within the audio range. However, this does not mean that the interfering signal is an audio signal: it may be produced by the beating together of two r.f. signals.

If, on the other hand, the frequency of the signal applied to the grid circuit of the picture tube is greater than the horizontal frequency, parts of each horizontal line will be made alternately dark and bright; as a result,

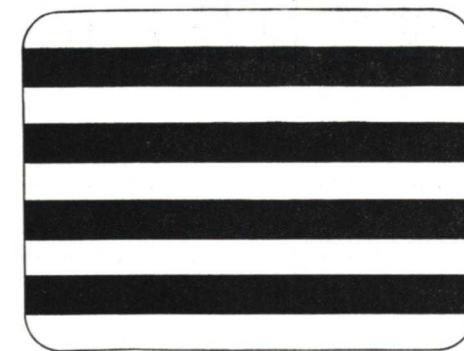

**FIG. 6. Horizontal bars of this sort are produced by interference having a frequency when it is applied to the picture tube that is less than that of the horizontal sweep. Roughly, the frequency of the interference in cycles is equal to 60 times the number of bars.**

vertical bars more or less like those shown in Fig. 7 will be formed. Here again, it may be possible to determine from the number of bars the approximate frequency of the interfering signal.

An interfering signal with a frequency higher than the horizontal sweep may cause lines that are perfectly vertical, as shown in Fig. 7, or that slope to either the left or the right. Whether the lines are vertical or sloping will depend upon the frequency and phase relationships of the

interfering signal to the horizontal sweep signal.

If the frequency of the interfering signal is constantly changing, a series

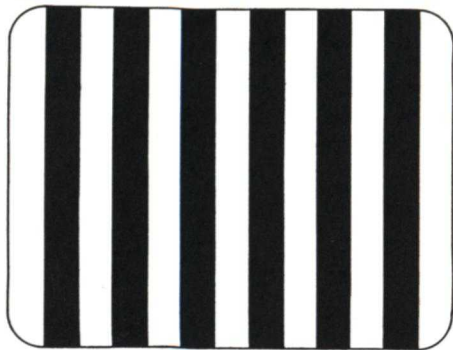

**FIG. 7.** Vertical bars of this sort are produced when the frequency of the interference applied to the picture tube is higher than the horizontal sweep frequency. The frequency of the interference is roughly equal to the horizontal sweep frequency times the number of bars.

of wavy lines, somewhat like those shown in Fig. 8, rather than stationary vertical lines or bars, will be set up. An f.m. signal, for example, will cause such a pattern.

Whatever the frequency of an interfering signal that is being picked up by the antenna or transmission line, it can usually be kept out of the set with the aid of a tuned circuit. Let's see what such interference eliminators are like.

## STUBS AND TRAPS

You already know that the resistance of a series resonant circuit is low at resonance. We can, therefore, use a series resonant circuit to eliminate an undesired signal by connecting it across the antenna terminals of a television receiver and tuning it to

the frequency of the interfering signal. The resonant circuit will then act as practically a short across the set terminals as far as the interfering signal is concerned, and the interference will either be eliminated completely or greatly reduced.

A parallel resonant circuit presents a high impedance across its terminals at the frequency to which the circuit is resonant. Another way of removing interference, therefore, is to connect a parallel resonant circuit tuned to the interfering signal in series with one of the leads to the receiver. Most of the interfering signal will then be dropped across the parallel resonant circuit and very little will be applied to the input of the TV receiver.

A piece of transmission line cut to the correct length will act as a series resonant circuit. Such a piece of line (which, since it is rather short, is called a "stub") can therefore be connected across the antenna terminals



**FIG. 8.** Wavy lines show that the frequency of the interference is changing.

of a set to eliminate interference. The connection of such a stub is illustrated in Fig. 9A.

Two types of stubs may be used: the "open" and the "shorted" stub.

The shorted stub is about a half wave length long at the frequency of the station to be eliminated. The open stub, on the other hand, is approximately one quarter of a wave length long.

To make a shorted stub, the ends of the transmission line are stripped clean of insulation, twisted together, and soldered to form a short circuit

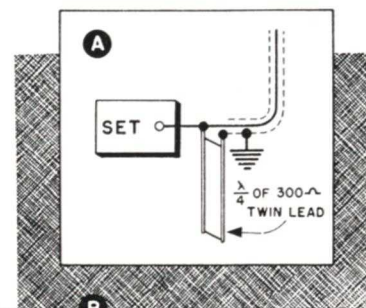

CHANNEL CAUSING INTERFERENCE	STARTING LENGTH OF STUB	
	OPEN 300-Ω LINE TO SET	SHORTED 300-Ω LINE TO SET
2,3	45"	90"
4	40"	80"
5,6	35"	70"
FM	30"	60"
7-13	16"	32"

**FIG. 9.** Part A shows how a stub should be connected to a transmission line; part B shows the starting lengths of open and shorted stubs made of 300-ohm line for use with different channels.

at the end of the line. An open stub is made simply by cutting off the correct length of transmission line, leaving the ends open. Obviously an open stub is much easier to make. Further, it is easier to work with, because a stub must be adjusted in length to make it perform properly after it has been connected to the set; and it is much simpler just to snip a bit off the

end of an open stub than it is to connect the ends of a shorted stub again after cutting a piece off of it.

When you use a stub, start with one that is somewhat longer than is needed. The starting lengths for stubs made of 300-ohm twin-lead line are given in Fig. 9B for various channels. Connect the stub to the antenna terminals of the set, then cut off half-inch sections from its end until there is some noticeable effect upon the interference. As soon as you begin to notice an effect, reduce the length of the sections you cut off to a quarter inch or less. If you reach a point where the interference is completely eliminated, stop.

In most cases, however, it will be impossible to eliminate the interference completely. Instead, as you continue to cut off lengths of the stub, you will find that the interference first decreases, then begins to increase again. When this happens, you will have made the stub too short, and you will have to start over again. This time, however, you will know approximately how long the stub should be, and you will be able to recognize when you have made it the length that produces maximum interference elimination.

During your adjustments of its length, the stub should be placed as nearly as possible in the position that it will occupy after you have finished. Changing the position of the stub frequently has an effect upon its performance. Thus, if you stretch it out on the floor in front of the set for convenience while you are shortening it, you may find that it does not work properly when you place it behind the set afterwards. Another reason

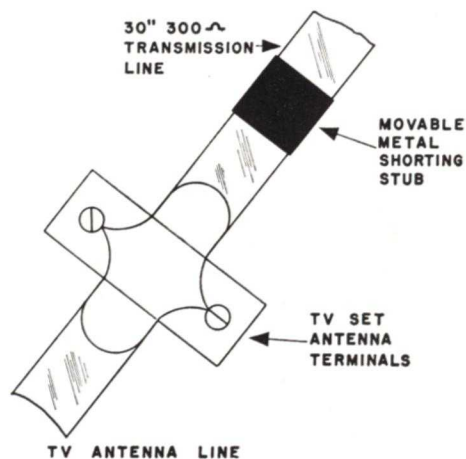

FIG. 10. How a piece of foil can be used to make an adjustable shorted stub.

for not changing the position of the stub as you adjust its length is that its performance may be affected by nearby objects.

An adjustable transmission line stub may also be made as shown in Fig. 10. Here the transmission line is connected to the antenna terminals of the TV set, and a piece of aluminum or tin foil is wrapped around the line. The piece of foil effectively shorts the line, even though it does not actually touch the conductors of the line. Therefore, the effective length of the stub can be adjusted by sliding the foil back and forth along the stub line until a position is found that clears up or minimizes the interference.

The use of a stub will cause a change in the r.f. response curve of the front end of a set on channels close to the frequency to which the stub is tuned. In some cases, this will cause smearing of the picture.

It has been found that this effect can be prevented by inserting a small condenser in series with each line of

the stub at the point where it fastens to the front end or antenna input of the receiver. These condensers should have capacities of 5 mmf. for stubs used in the low TV band and the f.m. band and about 2 mmf. for stubs used in the high band. Inserting these condensers makes the stub a series-parallel tuned trap that is much sharper in response and will not affect the response curve of the front end of the set unless the stub is tuned directly to the channel. The addition of condensers may make it necessary to use a longer piece of line for the stub.

If a coaxial transmission line is used between the antenna and the receiver, it is sometimes desirable to use a coaxial line stub. Fig. 11 shows how to terminate the end of a coaxial line that is to be used as a shorted stub.

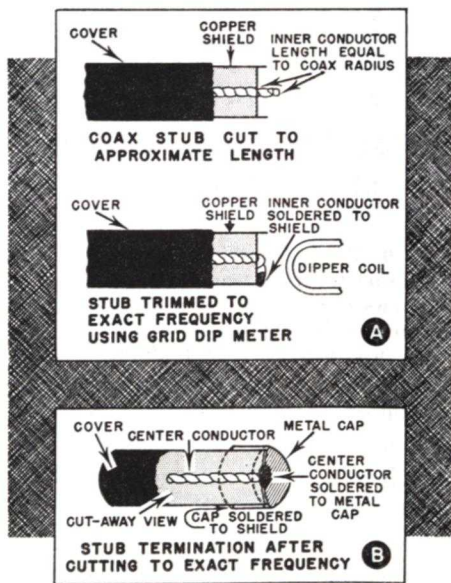
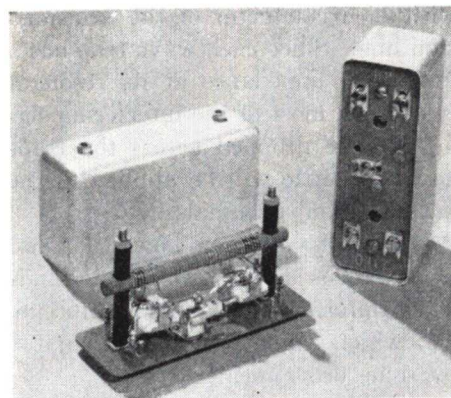

FIG. 11. A coaxial stub should be terminated as shown in part A. It should then be capped (part B) to prevent radiation from its end.



Courtesy Crystal Devices Co.

FIG. 12. A commercial wave trap.

**Wave Traps.** If the station causing the interference is comparatively low in frequency, a transmission line stub may have to be impractically long to eliminate the interference. In such cases, you should use a wave trap tuned to the frequency of the interfering station instead of a stub. Wave traps are even used for some of the higher-frequency stations to avoid the need for having an extra piece of transmission line hanging from the set. Commercial wave traps are available; one is illustrated in Fig. 12.

Electrically the wave trap may take one of several different forms. Fig. 13A is the schematic diagram of the commercial wave trap in Fig. 12.

The transmission line from the antenna is connected to the terminals marked "in" on the wave trap and the transmission line running from the receiver is connected to the terminals marked "out." Thus, with the wave trap connected, coils  $L_1$  and  $L_3$  are inserted in series with the transmission line. Coil  $L_2$ , tuned by condenser  $C_1$ , is coupled to coil  $L_1$ ; and coil  $L_4$ , tuned by condenser  $C_2$ , is coupled to

$L_3$ .  $L_2-C_1$  and  $L_4-C_2$  thus act as absorption wave traps, absorbing energy from the line at the frequency to which they are tuned. To use this trap, therefore, all you need to do is insert it in the transmission line and adjust  $C_1$  and  $C_2$  until the interference is minimized.

Slightly different arrangements of absorption wave traps are shown in Figs. 13B and 13C.

A series resonant wave trap that is connected directly across the antenna input terminals is shown in Fig. 14. Electrically, this is approximately the same as the quarter-wave open stub or the half-wave shorted stub previously described.

A wave trap of this sort is often not as effective as an absorption trap, because the attenuation it produces in the undesired signal depends upon how

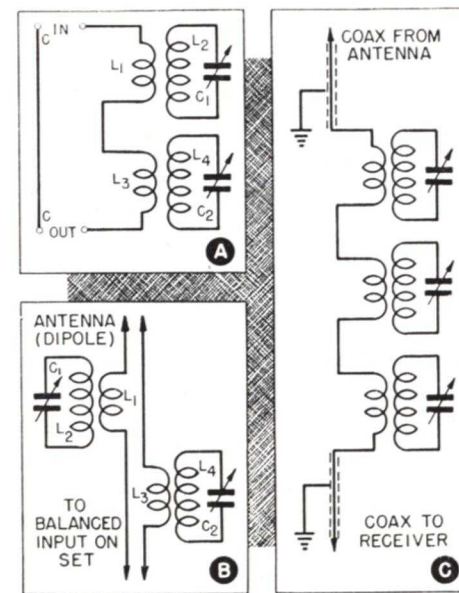

FIG. 13. Three forms of absorption wave traps. The one in part A is pictured in Fig. 12.

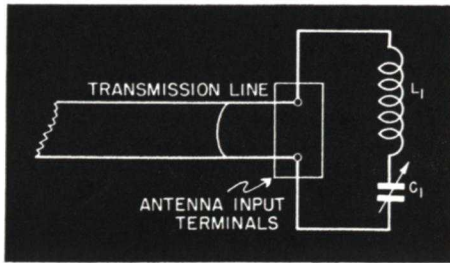

FIG. 14. A series resonant wave trap. As the text shows, this is often not as effective as an absorption trap is.

low its impedance becomes at resonance in comparison to that of the receiver. Since the input of a receiver has a comparatively low impedance, a series trap may not be able to become low enough in impedance to produce sufficient attenuation of the undesired signal.

Fig. 15 shows how parallel resonant wave traps can be used. Notice that a trap is connected directly in series

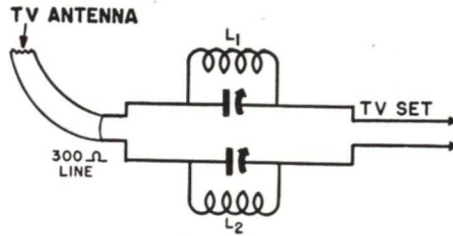

FIG. 15. A pair of parallel resonant wave traps. The inductance and capacity should be chosen to make the traps resonant at the frequency of the interfering signal.

with each conductor of the transmission line. Since each wave trap has a very high impedance at its resonant frequency, most of the interfering signal will be dropped across the traps and very little will be applied to the receiver input terminals.

Now that you know how stubs and traps are used, let's see which kinds of r.f. interference they can eliminate and which kinds must be eliminated by some other means.

## Eliminating R.F. Interference

F.M. signals can interfere with both low-band and high-band TV signals. Interference with high-band stations may occur because of radiation of second harmonics by an f.m. station. The f.m. band, as you know, extends between the frequencies of 88 and 108 mc. The second harmonics of these frequencies lie between 176 and 216 mc. Thus, the range of these second harmonics coincides almost exactly with the range of the upper TV band (which is 174 to 216 mc.). If an f.m. station does not have good second-

harmonic suppression (and some do not), therefore, it can easily interfere with one of the high-band stations. A typical example of the effect produced by f.m. interference is shown in Fig. 16.

If you find f.m. interference on one of these channels, about the only thing that you can do is use a highly directive antenna and attempt to orient it so that the pickup from the f.m. station will be reduced to a minimum. It is impossible to use a stub or a wave trap to eliminate interference of this sort, because these devices must be

tuned to the frequency of the interfering signal to be effective. Since second-harmonic f.m. interference comes in on top of a TV signal, the use of a stub or a wave trap to eliminate the

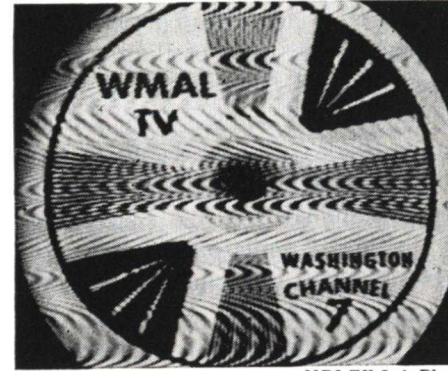

NRI TV Lab Photo

FIG. 16. Wavy interference of this sort that is continually changing is characteristic of f.m. interference. The variations in the pattern produced are caused by the continually changing frequency of the interfering signal.

interference will eliminate the desired signal as well.

An f.m. signal can also produce image interference, particularly on channel 2. To see why, let's suppose we have a typical TV receiver having a picture i.f. of 25.75 mc. On channel 2, the picture carrier frequency is 55.25 mc. The local oscillator of our set will therefore be operating at a frequency of 81 (55.25 plus 25.75) mc. when the set is tuned to this channel.

If a signal exactly 25.75 megacycles higher than the frequency of the local oscillator is picked up by the set, it can very easily beat with the signal from the local oscillator to produce an i.f. signal. Such a signal, as you know, is called an image. Adding 25.75 mc. to the oscillator frequency of 81 mc., we find that the image frequency for

channel 2 is 106.75 mc., which is within the f.m. broadcast band.

Thus, a strong f.m. station can cause image interference on channel 2 if the front end of the TV set does not have sufficient selectivity to reject the image frequency. As you learned in your earlier studies of TV input tuners, many sets do not have this much selectivity.

There are several methods that may be used to reduce or eliminate f.m. image interference. A series wave trap, an absorption trap, or a stub (either a quarter-wave open stub or a half-wave shorted stub) may be used. A quarter-wave open stub is perhaps the most commonly used of these, because it is as effective as any other device in the elimination of this type of interference, and it is comparatively easy to make and adjust. If you wish to use an open stub to eliminate f.m. image interference, start with a sec-



NRI TV Lab Photo

Another form of interference pattern caused by f.m. pickup.

tion of line about 32 inches long, then shorten it as previously described until the interference is minimized.

In addition to using a stub or a wave trap to knock out this type of



interference, try reorienting the antenna. You may find that there is a position for the antenna where pickup from the f.m. station is at a minimum but where there is still satisfactory signal pickup from the TV station.

Also, a booster may be helpful. It will increase the gain at the frequency of the TV signal and improve the image rejection of the receiver. If the previous suggestions are not successful, try a booster.

### INTERFERENCE FROM LOCAL OSCILLATORS

Interference may be caused by radiation from the local oscillator of a nearby TV or f.m. receiver. A TV receiver with an i.f. of between 21 and 27 mc. in which the local oscillator operates above the incoming signal may often cause interference with

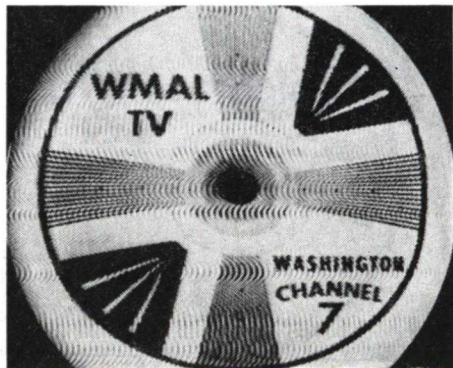

NRI TV Lab Photo

FIG. 17. Interference of this sort can be produced by the local oscillator of a nearby TV or f.m. set. You can distinguish it from other kinds of r.f. a.m. interference by the fact that the number and positions of the lines will change when the tuning of the interfering oscillator is changed. When the tuning operation stops, the pattern may change to that in Fig. 18.

other sets. When the set is tuned to channels 2, 3, 7, 8, and 9, the local oscillator will be operating on channels 5, 6, 11, 12, and 13 respectively.

When the set is operating on channel 2 (54-60 mc.), for example, and the i.f. is 21 mc., the operating frequency of the local oscillator is approximately 81 mc., which is within channel 5 (76-82 mc.). Similar examples may easily be set up to show how interference can be caused on other channels.

The local oscillators of some f.m. sets operate at a frequency lower than the incoming signal. As a result, the local oscillator of such a set may operate within television channels 5 or 6.

Interference will be caused in a receiver by radiation from a nearby TV or f.m. set having a local oscillator operating at a TV frequency if there is not sufficient isolation between the mixer stage and the antenna of the offending set. If the isolation is insufficient, the signal from the local oscillator will be fed back to the antenna and radiated. If this radiated signal is picked up by a TV set, it will produce an interference pattern like that shown in Fig. 17.

There is little that can be done at the TV receiver itself to eliminate this interference unless the pickup is direct and not through the receiving antenna. If there is a direct pickup from a nearby set (in another apartment, for example), it is sometimes possible to cut down the interference or to eliminate its effect by using a shielded transmission line or by carefully shielding the TV receiver. In some instances, it has been found necessary to cover the inside of the TV cabinet with shielding screen.

In most cases, however, steps for eliminating this type of interference must be taken at the *interfering* receiver. The easiest way to eliminate this trouble is to use a booster amplifier between the antenna input of the set and the antenna.

Of course, you are likely to find it difficult to persuade the owner of an interfering TV receiver to spend the money for a booster. He will probably decide that since his set is working all right, the fact that somebody else's set is having trouble is due to a defect in that receiver rather than in his. Even if he can be convinced it is due to a defect in his receiver, or perhaps we should say to poor design in his receiver, very often he will not be willing to go to the expense of installing a booster.

### AMATEUR INTERFERENCE

There are three possible ways in which an amateur transmitter may cause interference in a TV set. First, there may be excessive harmonic radiation from the amateur transmitter at a TV frequency. Second, the amateur signal may be able to get directly into the i.f. stages. Third, the amateur station may be operating on a frequency near the TV channels and simply be getting through the set because of the strong signal from the station and the poor selectivity of the TV receiver.

Two amateur bands, the 21-mc. and 28-mc. bands, operate near the i.f. frequencies of modern TV receivers. A signal from a nearby amateur station in one of these bands may get through the front end of the TV set into the i.f. amplifier. Many TV sets have i.f. traps in the front end that

can be adjusted to eliminate such interference or to reduce it to a minimum.

If a set suffering from such interference does not have an i.f. trap, you should add one. Install it across the transmission line if you use series resonant traps. For these amateur bands, 14 turns of No. 22 enameled wire on a form  $\frac{3}{4}$  of an inch in diameter with the windings spaced to fill about  $\frac{3}{4}$  of an inch will make a suitable trap coil. Use a variable tuning condenser having a capacity rating of 15 to 20 mmf.

Harmonics from the amateur transmitter are probably the most common cause of amateur interference. These may affect the test pattern as shown in Fig. 18. In some instances, horizontal lines like those shown in Fig. 19 may be produced.

The chart shown in Fig. 20 shows the relationship of the most widely used amateur bands to the TV channels. Harmonics that fall into any of the assigned TV channels have asterisks beside them.

Interference from harmonics of the



Courtesy Sylvania Electric Products, Inc.

FIG. 18. Harmonics from an amateur or any other a.m. transmitter may produce regular lines of this sort. They will not change if the frequency of the transmitter does not change.

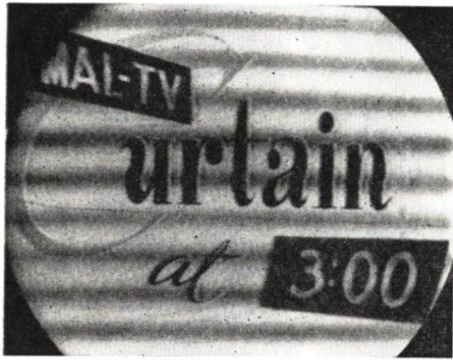

NRI TV Lab Photo

**FIG. 19.** Another form of interference that may be produced by an amateur or other a.m. transmitter.

amateur station may best be reduced or eliminated at the transmitter itself. A quarter-wave shorted stub is very effective in the elimination of even-harmonic interference. The quarter-wave shorted stub is cut to the fundamental frequency of the transmitter. It will then act as a parallel resonant circuit (high impedance) at the fundamental. At even-harmonic frequencies (second, fourth, etc.), the stub will act as a series resonant circuit (low impedance) and will effectively reduce the even-harmonic radiation.

The harmonic radiation may not

necessarily be coming from the amateur antenna. It may be radiating from one of the buffer stages in the transmitter. The remedy in this case is to shield the transmitter completely. All shielding should be properly bonded, and the shield should be grounded at one point. In addition, a power line filter similar to the one shown in Fig. 21 should be used.

In some cases, key-clicks may be noticeable from an amateur station. They may be eliminated by the use of a better key-click filter and by the use of an r.f. filter (as shown in Fig. 21) in the power line. They can also be eliminated by redesigning the transmitter to use a vacuum tube to key the equipment.

Of course, you cannot do anything about curing the trouble at the transmitter end unless the amateur is willing to cooperate. Most of them will be. Most, too, will know what steps should be taken to eliminate the trouble, because the amateur magazines are continually running articles on eliminating amateur interference.

Incidentally, when harmonic interference is encountered on channel 2,

AMATEUR FREQ. (mc.)	X 2 (mc.)	X 3 (mc.)	X 4 (mc.)	X 5 (mc.)	X 6 (mc.)	X 7 (mc.)	X 8 (mc.)	X 9 (mc.)	X 10 (mc.)
3.5	7	10.5	14.0	17.5	21.0	24.5	28.0	31.5	35.0
7.0	14	21	28	35	42	49*	56*	63*	70*
14.0	28	42	56*	70*	84*	98	112	126	140
21.0	42	63*	84*	105	126	147	168	189*	210*
27.0	54*	81*	108	135	162	189*	216*	243	
28.0	56*	84*	112	140	168	196*	224		
50.0	100	150	200*						

**FIG. 20.** Chart of the harmonics of the most popular amateur frequencies. Those that have an asterisk beside them fall in one of the TV channels.

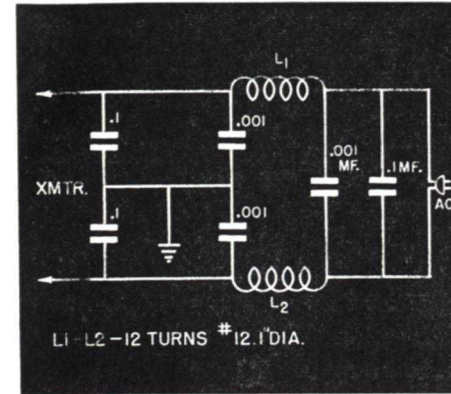

**FIG. 21.** This r.f. filter will help keep amateur harmonic radiation out of the power line.

it is due to harmonics from an amateur transmitter that is operating in the 28-mc. band. Remember, the amateur transmitter has a legal right to be operating in that band; and the FCC recognizes that certain harmonics will be radiated. Recent studies indicate that interference from second-harmonic radiation of a 28-mc. transmitter can be expected on channel 2 up to a mile from a 750-watt transmitter having a harmonic suppression of 42 db. Interference from the third harmonic of a transmitter usually will not cause any trouble except in the immediate vicinity.

Amateur stations operating on the 6-meter band also cause TV interference. This band is located directly beside television channel 2. As a result, amateur stations operating in this band will get through the front end of a nearby TV set, because the set does not have sufficient selectivity to reject the undesired signal. A 6-meter transmitter will cause considerable interference on channel 2 on nearby TV receivers and may even affect the entire low band.

A quarter-wave open stub used on the receiver transmission line may be helpful in reducing this type of interference. There is nothing that can be done at the transmitter, because the fundamental of the transmitter causes the trouble.

In addition to using the quarter-wave stub, using a highly directive antenna array and orienting it for minimum pickup from the amateur station may be helpful. However, if the amateur station is located in the same direction as a television station, the chances are that this solution will be impractical.

Fortunately, the 6-meter amateur band is not as popular as the lower-frequency amateur bands—in fact, the number of stations operating on 6 meters is small in comparison to the number on the other amateur bands. As a result, interference from 6-meter stations is not very widespread.

The previous information on reducing amateur interference can also be applied to the lessening of interference caused by commercial short-wave stations operating on frequencies near the TV channels or on frequencies having harmonics that fall in TV channels. Harmonic interference from these commercial stations is likely to be less severe than it is from an amateur station. The commercial stations have had the benefit of good reliable design by competent engineers, whereas some of the amateur stations are lacking in this respect.

### INTERFERENCE FROM BROADCAST STATIONS

Interference may be caused by nearby a.m. broadcast stations. This interference will look something like

a wire mesh across the face of the cathode ray tube.

Moving and redirecting the TV antenna usually does not help too much in this case, because the trouble is due to the fact that the signal blankets the area. The most effective method of reducing this interference is to use a high-pass filter like that shown in Fig. 22.

It is not usually sufficient simply to connect this filter between the transmission line and the antenna terminals of the receiver. Usually there

to the other side of the high-pass filter.

If the TV signal is weak, increasing its strength may be helpful in reducing the effect of this interference. Using a better antenna, raising the antenna, or using a booster may prove helpful.

### CO-CHANNEL INTERFERENCE

When the FCC originally assigned the television channels, it was assumed that a TV signal would not travel a very great distance beyond the line of sight. The geographical separation of stations on the same channel was

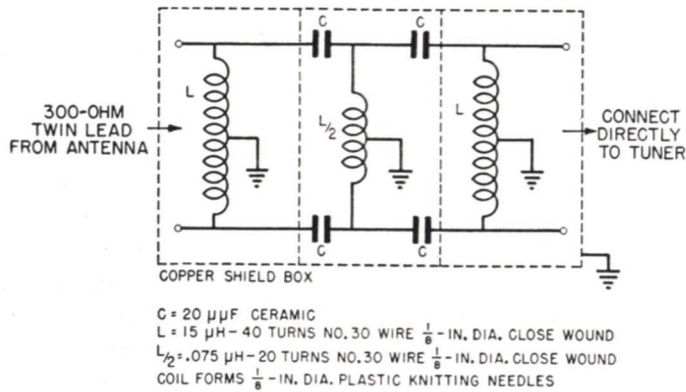

**FIG. 22. Use of this high-pass filter will reduce interference caused by a powerful nearby a.m. broadcast station.**

is a fairly long piece of transmission line between the antenna terminals of the receiver and the input to the tuner. When there is a strong signal from a local a.m. broadcast station, sufficient signal may be picked up in this short length of line to cause considerable interference. The best thing to do is to disconnect the transmission line at the point where it is connected to the front end of the receiver. Then connect one side of the high-pass filter directly to the tuner input, and connect the transmission line coming from the antenna terminals of the receiver

set with this assumption in mind. Experience has proved, however, that there is a certain amount of bending of a TV signal; and, as a result, signals travel a good distance beyond the horizon. Consequently, the problem of co-channel interference has arisen in some locations.

Such interference occurs when it is possible to pick up signals from two different stations that are on the same channel. Let's say that a set is located between two channel 4 stations that are 175 miles apart and is 50 miles from one station and 125 miles from

the other. If conditions are favorable, it will be possible to pick up the nearer channel 4 station well. The other channel 4 station may not be received well enough to give a satisfactory picture, but it may be possible to pick up enough signal from it to cause inter-

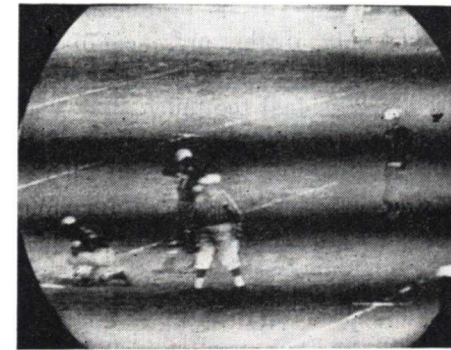

*NRI TV Lab Photo*

**FIG. 23. The "venetian blind" effect produced by co-channel interference may look like this.**

ference with the signal from the first station.

Such interference occurs whenever the signals from the two stations differ in frequency by a small amount. Theoretically, both stations should be operating on exactly the same frequency, but they may easily differ by a few hundred cycles and still be well within the frequency tolerance limits set by the FCC. When both signals are received, a beat note having a frequency equal to their frequency difference will be produced and eventually applied to the picture tube, causing an interference pattern like that shown in Fig. 23. This interference produces a series of alternate black and white bars across the image, for which reason it is called the "venetian blind effect." The number of bars depends, of course, on the differ-

ence in frequency of the two carriers. If this difference is less than 60 cycles, no visible bars will be produced; but, unless the two carriers are exactly synchronized in frequency, there will be an annoying variation in brightness of the picture.

The only hope of eliminating such interference at the receiver is to use a more directive antenna in an effort to attenuate the undesired signal so much that it will produce no appreciable effect. If this does not work, there is nothing else that can be done at the receiver to eliminate the interference.

Fortunately, however, a simple method of adjusting the transmitter to eliminate this interference completely has been worked out. It is likely that it will be adopted very soon, in which case co-channel interference will no longer be a problem.

This method consists of adjusting the two transmitters so that they are exactly 10,500 cycles different in frequency. When the frequency difference is this great, the bars produced are so numerous and so thin that they disappear completely.

### ADJACENT-CHANNEL INTERFERENCE

Adjacent-channel interference is not likely to occur in large cities to which TV channels have been assigned, because such cities are generally located so far from others to which adjacent channels have been assigned that it is impossible to pick up the adjacent-channel signals. A receiver located between two cities to which adjacent channels have been assigned may suffer from interference of this sort, however.

To take a specific example, let's suppose that a set is located between a city to which channel 3 has been assigned and another city to which channels 2 and 4 have been allocated. Let's suppose further that reception is such that all three of these channels can be picked up. If so, the broad response of the front end and the i.f. stages of the set will probably permit the set to pick up interference from both channel 2 and channel 4 when it is tuned to channel 3.

Such interference will probably be caused by the sound carrier of channel 2 and the picture carrier of channel 4. The sound carrier frequency of channel 2, for example, is 59.75 mc., and the local oscillator of the set (assuming it has the usual sound i.f. of 21.25 mc. and picture i.f. of 25.75 mc.) will be operating at 87 mc. when the set is tuned to channel 3. The beat between the sound carrier of channel 2 and the local oscillator frequency when the set is tuned to channel 3 will therefore have a frequency of 27.25 mc., which is near enough to the i.f. frequencies to get through the set and cause interference.

Similarly, the picture carrier frequency of channel 4 (67.25 mc.) will beat with the local oscillator of a set tuned to channel 3 to produce a frequency of 19.74 mc. This will probably also pass through the i.f. stages and produce interference.

There are several things that might be done to reduce adjacent-channel interference. Some receivers contain adjacent-channel sound traps and adjacent-channel picture traps that are designed to eliminate it. Properly adjusted, such traps are very effective.

The use of a more directive antenna should be tried. It may be possible to reduce the pickup from the interfering station to such a low level that the interference will not be objectionable.

It may also be possible to use a stub cut to a frequency near that of the interfering station to attenuate the interference. This is practicable, of course, only if the presence of the stub does not reduce the strength of the desired signal too much.

Sometimes the use of a pad that reduces the signal strength of all incoming signals will prove helpful. We shall discuss pads a little farther on in this Lesson.

### NOISE

Noise produces dark spots or streaks across the picture tube. Probably the most common source of this kind of interference is automobile ignition systems. The effects of light and heavy interference of this sort are shown in Figs. 24A and 24B respectively. Notice that heavy ignition interference may destroy the horizontal sync action.

Frequently a great deal of auto ignition interference is picked up by the

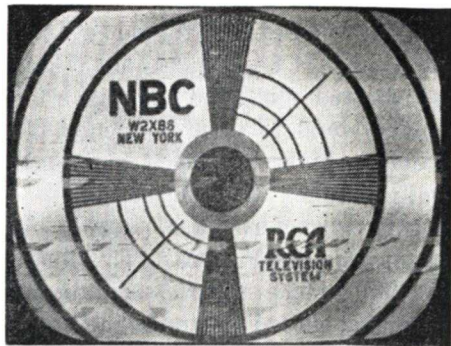

*Courtesy RCA*

**Interference caused by some form of noise.**

transmission line rather than by the antenna. If such interference is severe, you should try a shielded transmission line. If the interference is light, it may be possible to use an unshielded line provided it is placed as far as possible away from the street. Even if the interference is light, the use of shielded line is preferable from every standpoint except that of cost.

Placing the antenna as high as possible is helpful. In addition, if the interference is being picked up by the antenna itself, it is often worth while to use a stacked array. As you know, a stacked array picks up much less noise from a source below it than a dipole does.

Automobile manufacturers are cooperating with TV manufacturers, and the new cars do not cause nearly as much ignition interference as do the older ones. In time, therefore, as the older cars go off the roads, ignition interference will probably be reduced considerably.

Noise may also be produced by various other electrical devices. Any device in which a motor is used may produce interference if the motor is not properly adjusted or if sparking occurs between the brushes and the commutator. In addition, ultra-violet lamps, neon signs, electric razors, and similar spark-producing devices may cause considerable interference.

In each of these cases, the use of a line filter should prevent interference from getting into the set through the power line. Of course, to be most effective, the filter should be placed at the interfering piece of equipment. When the device cannot be located or if it is impractical to place the filter at this point, however, try installing

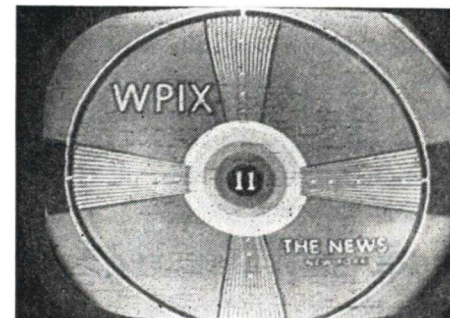

*Courtesy Sylvania Electric Products, Inc.*

**FIG. 24A. Light ignition interference causes streaks of this kind across the picture.**

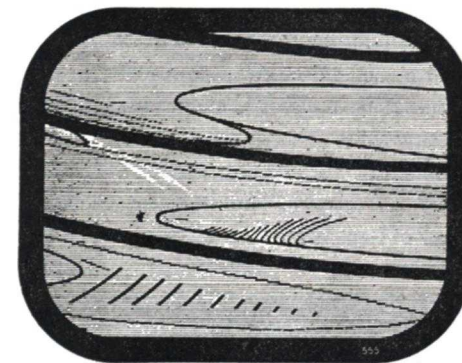

*Courtesy Belmont Radio Corp.*

**FIG. 24B. Heavy ignition interference may make the set lose horizontal sync, as shown here.**

the filter between the receiver and the power outlet.

Again, as in the case of auto ignition, much of the interference may be picked up by the transmission line, so the use of shielded line may help to reduce the interference. Getting the antenna higher to keep it as far away as possible from the interference may do some good.

A booster is sometimes useful in reducing noise interference if the interference is noticeable simply because the signal from the TV station is weak. In this case, increasing the sig-

nal from the TV station by the use of a booster will reduce the effect of the noise. If the interference is being picked up by the antenna, however, a booster will do little good, because the noise will be amplified along with the desired signal.

### DIATHERMY INTERFERENCE

Diathermy interference is caused by radiation from the oscillator of a diathermy machine (a piece of equipment used by doctors in giving heat treatments). The newer machines are designed to minimize such radiation: in some, second-harmonic radiation (which is the most troublesome, because it is in the TV spectrum) is kept as low as 5 microvolts per meter. However, older equipment radiates very strongly, causing interference that often cannot be eliminated.

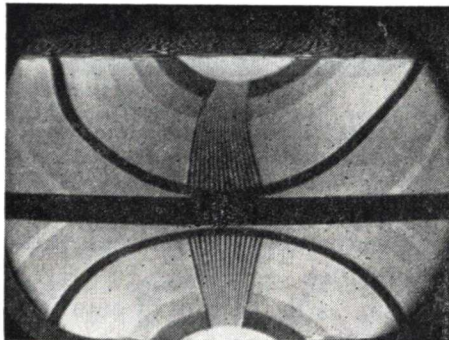

*Courtesy Sylvania Electric Products, Inc.*

**Loss of vertical sync caused by diathermy interference.**

The effect of diathermy interference on the test pattern is shown in Fig. 25. The herring-bone pattern may move vertically, or it may remain stationary as shown. If the interference is extremely strong, it may completely blank out the test pattern on one or more stations.

Filtering the antenna circuit with a high-pass filter may help to some extent if the interference is very broad. Repositioning the antenna to reduce pickup from the interfering source to a minimum and using an antenna with

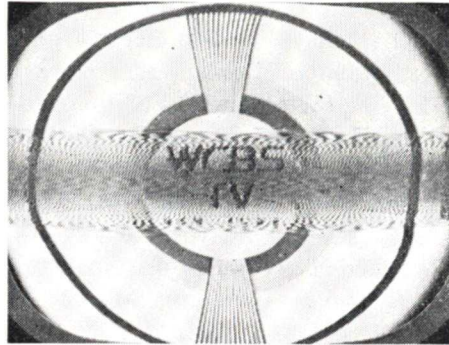

*Courtesy Sylvania Electric Products, Inc.*

**FIG. 25. A typical example of diathermy interference. Usually such interference will cause either one or two bands across the picture, since diathermy machines (which are essentially h.f. and v.h.f. oscillators) are usually modulated at either 60 or 120 cycles, depending on whether a half-wave or a full-wave rectified power supply is used. The modulation occurs because the power supply is not usually filtered.**

a sharper pattern may also be helpful. Sometimes a stacked array will not pick up this interference to the extent that an ordinary dipole or folded dipole will. If the pickup occurs in the transmission line, the use of a shielded line should eliminate it.

Diathermy interference can best be eliminated at the source, if the source can be found. Usually you can find out which doctors in the neighborhood have diathermy equipment. Then, when the interference is present, you can telephone each doctor to see if his equipment is turned on at that moment.

If the doctor is willing to permit you to take steps to eliminate the interference, shield the diathermy oscillator completely. This will keep radiation from the oscillator itself to a minimum.

In addition, filter the power supply to the equipment. Use an r.f. filter like the one shown in Fig. 21.

Fortunately, diathermy equipment is usually not used too much during the evening hours when television programs are on the air.

### IDENTIFYING R.F. INTERFERENCE

Since the measures you take to eliminate r.f. interference often depend on what kind of interference is being picked up, it is usually necessary for you to identify the interference before you can remove it. Fortunately, it is generally easy to do so by observing the effect produced on the picture by the interference.

We have illustrated most of these effects in the preceding sections of this Lesson. Study the pictures carefully so that you will be able to identify each type. Most of them are distinctive enough so that you will have very little difficulty in telling them apart. Noise, for example, causes streaks or dots across the face of the tube; diathermy produces a herring-bone pattern; and so on.

Interference from amateur stations and from f.m. stations may be somewhat difficult to distinguish between, since both cause diagonal lines across the face of the tube. The lines caused by an amateur station are usually straight, however, whereas those caused by an f.m. station are not. Further, the number of lines caused

by an f.m. station varies constantly, because the frequency of the station is continually changing; but an interfering amateur station will usually produce a constant number of lines.

Another distinguishing feature is that amateur interference is not present all the time, because amateur stations are operated intermittently. On the other hand, interference caused by an f.m. station is usually present throughout practically the entire day and evening.

If interference is caused by a radio station, try to pick up its call letters. Doing so will let you find out what the fundamental frequency of the interfering frequency is, which may make it easier for you to determine why the interference is occurring. If it is the picture rather than the sound that is interfered with, you will not hear the interfering frequency when the set is correctly tuned. However, you may find it possible to hear it if you misadjust the fine tuning control (if the set has one) so as to increase the frequency of the local oscillator, thereby making the beat frequency of the interfering signal and the oscillator signal fall within the sound i.f. range. Even if the interference is amplitude modulated, you will probably be able to hear it through the f.m. sound system of the TV set; it will undoubtedly be distorted, but you should be able to make out what is being said.

### SIGNAL STRENGTH

In many cases, the success you will have in eliminating interference will depend upon the strength of the signal from the TV station. The stronger the signal, the better your chance of

eliminating the interference. If the signal is relatively weak, it may be difficult or impossible to eliminate the interference without also attenuating the signal from the television station to such an extent that it is unusable.

When the signal from the TV station is weak, therefore, it is usually worth while to spend some time attempting to increase its strength before trying to knock out the interference. Use a high-gain antenna and a booster to build up the signal strength in such a case. Then you can use traps or stubs to knock out the interference with some assurance that you will not reduce the strength of the desired signal too much.

#### **INTERFERENCE CAUSED BY TV RECEIVERS**

Several of the circuits in a TV set may interfere with other broadcast services. In addition to being called upon to eliminate interference in a TV receiver, therefore, you may also be called upon to eliminate interference that is caused by the TV receiver.

Direct radiation from the video circuit may cause trouble in an a.m. broadcast receiver, for example. Remember, the video circuits in a receiver handle frequencies all the way from about 15 or 20 cycles up to 4.5 megacycles. As a result, there are strong signals present in the video circuits that fall within the frequency range of the standard broadcast band. If there are any long leads in the video circuits, there may be considerable radiation that will affect nearby broadcast receivers.

Such interference makes the a.m. set sound mushy. Considerable back-

ground noise of variable intensity is present. In some cases, the noise can be severe enough to obliterate weak stations completely. There may also be "birdies" caused by beating of some video components with broadcast carriers.

The most effective method of eliminating such interference is to shield the TV receiver. It may be necessary to build a wire mesh shield completely around the inside of the TV receiver cabinet. This shield should then be grounded.

In receivers using the intercarrier sound system, the 4.5-mc. sound may radiate, causing trouble with services on or near this frequency, if the leads in the set are long and unshielded. Shielding any long leads should be effective in eliminating this difficulty.

The scanning systems in a TV receiver may cause trouble because they are rich in harmonics. The vertical sweep is usually not troublesome, since it operates at the low frequency of 60 cycles per second. The horizontal sweep circuits, however, operate at a frequency of 15,750 cycles and have an output that is very rich in harmonics. These harmonics may cause "birdies" about every 15 kc. all over the dial of an a.m. set as they beat with broadcast station carriers.

In most sets in which electromagnetic deflection is used, the horizontal sweep circuit is shielded along with the high-voltage rectifier and the damping circuits. If you should find that these components are not shielded in a set that causes interference in a nearby radio receiver, shielding these circuits should be helpful.

In addition, radiation may occur from the yoke. An additional shield

may be made that can be slipped on over the yoke and grounded to the receiver chassis. Such a shield is usually quite effective in eliminating radiation from the yoke. If it doesn't remove the interference completely, it will be necessary to use a screen shield over the entire inside of the set (with the exception of the face of the picture tube).

We mentioned earlier that radiation from the local oscillator of the TV set may cause interference in nearby TV or f.m. sets. The best way to eliminate such radiation by the TV receiver is to install a booster between the offending receiver and its antenna.

There is one possible difficulty you should keep in mind if you are attempting to eliminate interference by shielding the inside of a TV receiver cabinet with a grounded wire mesh. Some TV receivers use power supplies that resemble the a.c.-d.c. circuits used in many of the lower-priced a.m. broadcast radios. In such sets, one side of the power line may be connected directly to the chassis.

Obviously, you must not ground the chassis in a set of this kind—if you do, you may put a short directly across the power line. Therefore, if you install a shield in one of these sets, be very careful not to allow the grounded

shield to come into contact with the receiver chassis.

#### **SUMMARY**

There are two main kinds of external r.f. interference—"blanket" interference and "station" interference. Blanket interference, such as diathermy, ignition, etc., can best be eliminated by going to the equipment causing the interference. The use of appropriate filters and shielding will usually eliminate the interfering radiation.

On the other hand, interference caused by a particular station, whether it be an f.m., an amateur, a short-wave, or some other station, can usually be eliminated by using wave traps or stubs at the receiver. Of course, if the interference is caused by excessive harmonic radiation from an amateur station, the elimination or the suppression of that harmonic at the station will be the most effective means of combating the trouble. When the interference is due to nearby stations that are operating on frequencies near the TV channel or near the TV i.f. frequency, however, the best way to eliminate the interference is to trap the interfering signal at the receiver.

# Special TV Installations

In this section, we are going to take up some special installation problems. One of these is the use of pads or some other means of cutting down extremely strong signals when the receiver is located close to the transmitter. Another is the installation of a receiver in an area where the correct type of power is not readily available. A third is making commercial installations—in taverns or restaurants, for example. The fourth is setting up a multiple-installation system for an apartment house or a dealer's store.

## STRONG SIGNAL AREAS

When you make a TV installation in an area where the signal strength

is excessive, you should use a pad to reduce the amount of signal fed to the set from the antenna to prevent the first stages in the set from being overloaded. Fig. 26 shows the circuits of four types of pads and the resistor values that should be used in the two most common of them to produce various amounts of attenuation. The balanced pads are used with 300-ohm twin-lead line, and the unbalanced pads are used with 72-ohm coaxial line.

In an area where there are several stations, it is unusual to find a location where the signals from all of them are too strong. It is somewhat more common to have the signal from one

station be extremely strong but those from other stations be only normal in strength. This condition occurs when the set is located very close to one transmitter but considerably farther from the others.

Since a pad will reduce the strength of all signals equally, a pad would be unsuitable in a location of this latter kind because we do not want to reduce the signal strength from the weaker stations. Instead, you should install a parallel resonant wave trap in the transmission line (one trap in each lead of the line if twin-lead is used), tuning it to the frequency of the overstrong station. This arrangement will usually attenuate the strong signal enough to prevent overloading.

Incidentally, you may wonder why we go to all of the trouble of designing pads to attenuate signals instead of simply inserting resistors in the leads between the transmission line and the antenna terminals of the receiver. The reason is that the transmission line would no longer be terminated with the correct impedance if we just installed resistors to attenuate the signals. The pads shown in Fig. 26, however, are designed so that they will have no effect on the impedance matching. In other words, when the resistances given in Fig. 26 are used, the impedance at the input and at the output of either of the balanced pads is 300 ohms; and, similarly, the input and output impedance of the unbalanced pads is 72 ohms.

## INSTALLATIONS IN D.C. AREAS

In some of the larger and older cities, there are areas in which d.c. power rather than the more common 60-cycle a.c. power is supplied over

the power lines. When public distribution of electric power was first undertaken by power companies, d.c. was the only kind used. Later, when the advantages of a.c. power became apparent, most new installations were equipped to deliver it. In some areas of the older cities, however, the expense of converting to a.c. was so great that the power companies continued and still continue to supply only d.c. to them.

A power transformer will not operate on d.c. As a result, TV sets using power transformers cannot be operated on d.c. If you are going to install a TV set in a d.c. area, you must either use a set designed for a.c.-d.c. operation or use some means of converting the d.c. from the power lines to 60-cycle a.c.

There are several devices that make it possible to change d.c. to a.c. You may use an inverter, a rotary converter, or a motor driven generator.

An inverter consists of a vibrator, a transformer, and a suitable filter assembly. One is shown in Fig. 27A. Commercially manufactured inverters are available from most wholesale supply houses.

The inverter has a few disadvantages. One of the most important, in this case, is that one large enough to supply a TV set that draws 300 to 350 watts is very expensive. Another is that some have a tendency to vary in frequency, an effect that may cause undesirable voltage variations in a TV set. There are inverters commercially available that can be synchronized with the field frequency of the TV signal so that their outputs are constant in frequency. Such devices are also very expensive, however.

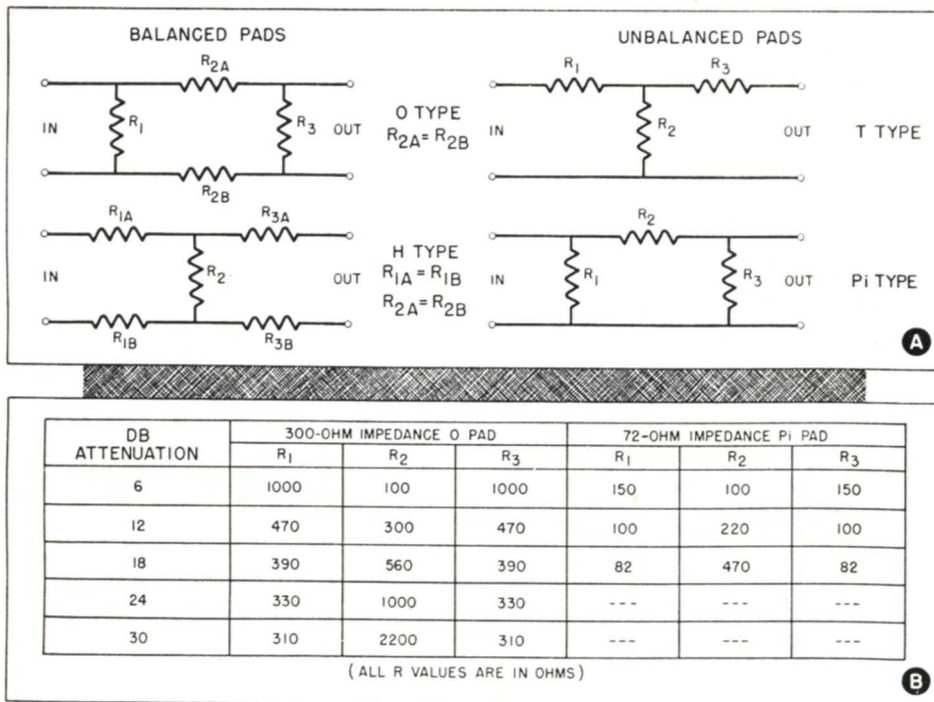
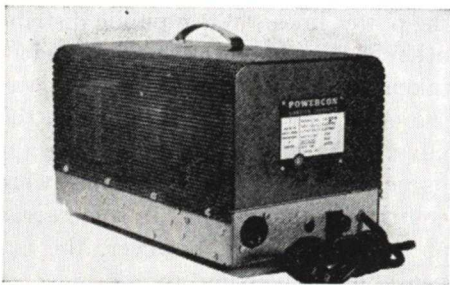
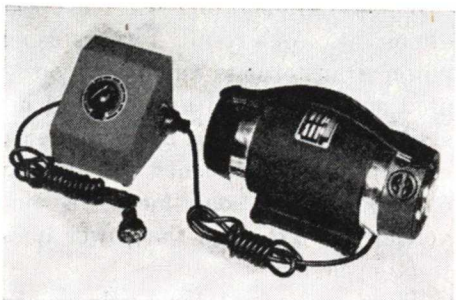

FIG. 26. The diagrams of O, H, T, and Pi pads are shown in part A, and design factors for O and Pi pads are given in part B.



Courtesy Cornell-Dubilier Electric Co.

FIG. 27A. A typical inverter used to change d.c. to 60-cycle a.c.



Courtesy Carter Motor Co.

FIG. 27B. This rotary converter is used to change d.c. to 60-cycle a.c. The small box contains a speed control device that permits the frequency of the output to be regulated.

It is also possible to change d.c. to a.c. by using a motor-generator assembly. This assembly is much the same thing as the rotary converter except that the motor and the generator are built separately and mechanically coupled together. Most such assemblies are designed to deliver large amounts of power and are too expensive to use if a TV set is to be the only load.

In selecting a device to convert d.c. to a.c., make sure that the unit can supply the a.c. at the proper voltage and frequency and also that it is large enough to furnish the current needed to operate the TV set. A TV receiver usually has a current requirement of several amperes at approximately 115 to 120 volts, 60-cycle a.c.

Many inverters and converters are given both an intermittent-duty and a continuous-duty rating. Be sure that the continuous-duty rating is high enough to handle the requirements of the TV set, because the set will probably be used for several hours during an evening. A device designed to supply the required current under intermittent conditions only would not be capable of handling the load.

#### INSTALLATIONS IN 25-CYCLE AREAS

Some American cities supplied by hydro-electric plants have 25-cycle rather than 60-cycle power. A TV receiver that uses a power transformer designed for 60-cycle operation will not work satisfactorily on 25 cycles; there is not sufficient iron and copper in the power transformer, and the transformer will burn out. Even if the power transformer would work, the chances are that there would not

be sufficient filtering in a 60-cycle receiver to give satisfactory performance on 25 cycles.

Therefore, if the customer's set is designed for 60-cycle operation and he wishes to use it in a 25-cycle area, about the only practical thing to do is to replace the power transformer with one designed for 25-cycle operation. It will probably also be necessary to increase the filter capacity to reduce the hum. This can be done by installing larger filter condensers or by connecting additional condensers across those already on the set. Be sure that the condensers being installed in the set have a working voltage that is at least as high as the working voltage of the condensers they are replacing.

If a suitable power transformer cannot be obtained, it may be possible to have one wound specially for the job. Such a transformer will be fairly expensive; however, about the only alternative is to use a frequency converter, which is considerably more costly.

The kind of frequency converter we refer to consists of a 25-cycle synchronous motor that drives a 60-cycle generator. This device has a constant-frequency output, because the output frequency is determined by the speed of the motor. Since it is a synchronous motor, its speed is determined by the frequency of the power line, which is practically constant.

Not all TV sets use a power transformer. Many sets use voltage-doubler and voltage-tripler circuits to obtain the necessary B-supply voltages. These circuits will not work on d.c., but they will work on 25-cycle a.c. power. When a receiver of this

type is to be installed in a 25-cycle area, therefore, satisfactory performance can usually be obtained simply by increasing the size of the filter condensers without making any other alterations in the set. For this reason, a customer buying a set for use in a 25-cycle area will find it cheaper to get a transformer-less type if a set with a 25-cycle transformer is not available. You may wish to point this fact out to customers or potential customers living in such an area.

#### COMMERCIAL INSTALLATIONS

In general, commercial installations are handled in the same manner as home installations. The problems encountered are very similar. One difference between them, however, is that there is seldom a high electrical noise level in a private home, whereas there is very apt to be one in a commercial location. A tavern or restaurant usually contains many electrical devices—automatic phonographs, refrigerators, electric washing machines, neon signs, and fluorescent lights, for example. Considerable interference may be radiated by one or more of these devices. If you notice that the noise level is comparatively high in the TV set, the interfering device can be identified by shutting off the various electrically operated machines one at a time. If you notice that the noise goes down when a certain machine is shut off, that machine is generating at least part of the interference. You can probably reduce the interference from each such machine by using a suitable filter in the power line to the device.

Noise pick-up in the transmission line from such devices or from nearby



automobiles can be kept to a minimum by using shielded transmission lines. For this reason, a shielded line is far superior to an unshielded line for a commercial installation. Since the charge for a commercial installation is usually somewhat higher than that made for a home installation, it is practicable from the cost viewpoint to spend the extra money for the shielded line.

Since people are often more careless about equipment in a commercial establishment than they are in a private home, make sure that the transmission line is securely fastened in place. If it is not, it may be kicked or pulled loose accidentally or someone may be injured by tripping over it. It is also a good idea to run the transmission line in such a manner

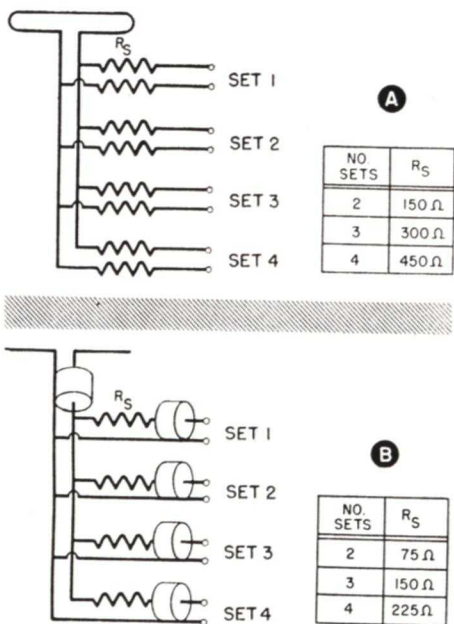

FIG. 28. Methods of connecting several sets to the same transmission line. The resistive networks permit the lines to be terminated in their characteristic impedances, thus eliminating line reflections.

that it will be as inconspicuous as possible.

Another difference between home and commercial installations is that there is usually only one set in a home but there may be several in a large commercial establishment. The use of several sets brings up the problem of connecting them to an antenna. Of course, one way of solving this problem is to use a separate antenna for each set. There may not be room for several antennas, however, or the proprietor may not want to use more than one. In this case, a distribution network must be used to feed the signal from a single antenna to several receivers.

Fig. 28 shows a simple way in which several receivers can be connected to a 300-ohm line (Fig. 28A) or a 72-ohm line (Fig. 28B). The matching networks shown permit the transmission line to be terminated in its characteristic impedance with the result that ghosts resulting from mismatch are avoided.

It is necessary to know the relative signal strength in a particular area before you can tell whether it is practical to connect 2, 3, or 4 receivers to the same antenna, because the total signal delivered by the antenna is divided equally among the sets. If there are two sets, for example, only half the signal fed to the line by the antenna is applied to each of them; if there are three, only one-third the signal is applied to each; and so on.

If the receivers are installed in a primary service area where the signal strength is comparatively high, it may be possible to connect many sets to the same antenna without any difficulty. In other cases, it may be nec-

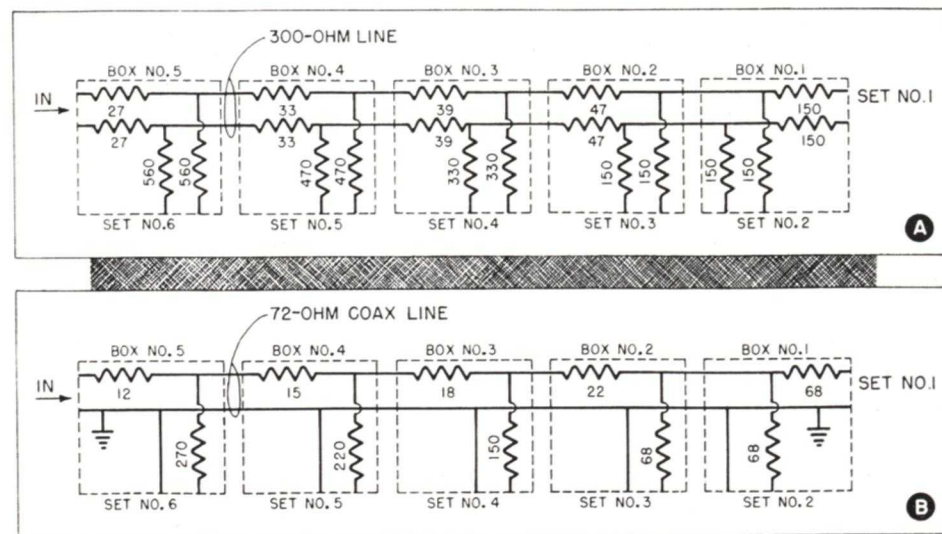

FIG. 29. These matching networks can be used to permit as many as 6 sets to be connected to the same line.

essary to use a high-gain antenna array or an array plus a booster to make up for the loss of signal strength as additional sets are connected to the antenna, even though such a high-gain system would not normally be required to get reception on a single receiver.

The circuit in Fig. 29 shows a complete matching network that can be used to connect as many as six separate receivers to the same transmission line. The network constants are such that signals of equal strength will be delivered to each receiver.

If fewer than six sets are to be connected to this network, the extra distribution boxes should be disconnected to keep the network in balance. For example, if only five sets are to be used, box No. 1 should be removed. The sets should then be connected to the positions marked set No. 3, set No. 4, set No. 5, and set No. 6. The fifth set should be connected to the leads that went to box #1. Similarly, if

only four receivers are to be used, boxes No. 1 and No. 2 should be removed, and so forth.

The circuit shown in Fig. 29A should be used for receivers having 300-ohm balanced inputs. The one in Fig. 29B is a similar network for use with a 72-ohm unbalanced system in which a coaxial cable is used.

## APARTMENT-HOUSE INSTALLATIONS

Many landlords will not permit tenants to install individual TV antennas on the roofs of their apartment houses. In cases of this sort, the TV set owner must generally use a window or an indoor antenna unless he has a set having a built-in antenna.

The effectiveness of such antennas, including built-in ones, depends on the location. In many places they work well, in others they are satisfactory if boosters are used with them. Very often, however, a TV receiver will fail

to give satisfactory performance unless it is connected to a suitable outside antenna.

Usually an apartment-house owner who will not permit each tenant to erect an outdoor antenna will allow one master antenna to be put up. For that matter, it may not be desirable for every tenant to put up his own antenna even if he is permitted to do so, because each antenna will have a certain effect on any other antenna near it. For this reason, antennas cannot be placed too close together; if they are, the result is that none of them works well. This fact creates a problem when there are a great many television sets in one apartment house, because it is impossible to erect enough antennas on the roof to take care of all of them without having the antennas so close together that all of them will be affected.

There is, therefore, a demand in apartment-house installations for a master antenna system that will furnish a signal for several receivers. In small apartment houses, systems like those shown in Figs. 28 and 29 may be suitable. A more elaborate system must generally be used for a large apartment house, however.

Several systems have been devised to answer the problem of apartment house installations. One of these is the Jerrold "Mul-TV Antenna System," which we shall describe briefly.

The simplest form of the Jerrold system is shown in block diagram form in Fig. 30. As you can see, it consists of a series of distribution boxes coupled to each other and to the antenna by 72-ohm coaxial transmission line. (For convenience in reference, we shall call this the distribution line.) A 72-ohm terminating resistor is connected across the end of the line.

Two kinds of distribution boxes, called ADO-1 and ADO-2 by the manufacturer, are used in this system. The ADO-1 is used to couple one 72-ohm set to the line, the ADO-2 to couple two 300-ohm sets to it. Either kind of box can be used anywhere in the system, so 72-ohm and 300-ohm receivers can be connected to the line in any proportion.

Each distribution box contains a cathode-follower amplifier and its power supply. The input of each box is connected across the distribution line; since this input consists of the grid circuit of the cathode follower

and therefore has a high impedance, it attenuates the signal in the distribution line only slightly. For this reason, a great many boxes can be connected to the line without attenuating the signal too much.

The output of each box is taken from the cathode circuit of the cathode follower. Therefore, the only connection between the input and the output is through the internal capacities of the tube, which are low. For this reason, there is practically no backward transmission (from output to input) of signals through the distribution boxes. This means that any signal feeding back from the local oscillator of a set that is connected to the output of a distribution box will be very severely attenuated before it is applied to the distribution line of the system. The distribution boxes thus act as decoupling devices to prevent the receivers connected to them from interfering with each other.

The manufacturer of this system offers several accessories that can be used to adapt it to meet various needs. For example, there is a matching transformer that permits the 72-ohm distribution line of the system to be matched to a 300-ohm line if it is necessary to use the latter with the antenna selected.

Another accessory device is a channel amplifier that is intended for use in low-signal areas or in installations in which the run of the coaxial distribution line is so long that the signal is attenuated too much. This amplifier contains four plug-in amplifier strips, each of which is a 6-tube r.f. amplifier that is designed to handle a particular channel. There is an individual gain control for each strip,

an arrangement that permits the outputs of all the strips to be adjusted to the same level. These individual outputs are applied to a mixing network from which they are fed to the main distribution line of the system.

Each amplifier strip of this device has its own input. If an individual antenna is used for each station that is to be picked up, the transmission line from each antenna can be connected to the appropriate amplifier input. If a single antenna is to be used for all stations, however, an antenna matching network offered by the manufacturer must be used. This network consists of six tuned circuits connected in parallel across an input terminal that is connected to the transmission line from the antenna. Each circuit can be tuned over a range of 20 mc., and their basic frequencies are staggered so that their combined range covers all the TV and f.m. frequencies. When this network is used, the antenna transmission line is connected to its input, and the proper outputs are connected to the individual inputs of the channel amplifier. The unused outputs of the network can then be used to trap interference if desired.

Another network offered by the manufacturer is the reverse of the one just described. It is intended to be used to couple the transmission lines from as many as six individual antennas to the single coaxial distribution line of the system. It is used only with unamplified systems, of course.

Finally, the manufacturer offers noise filters for each TV channel. These are intended for use only with amplified systems. Each is installed just ahead of the amplifier for the channel for which it is designed.

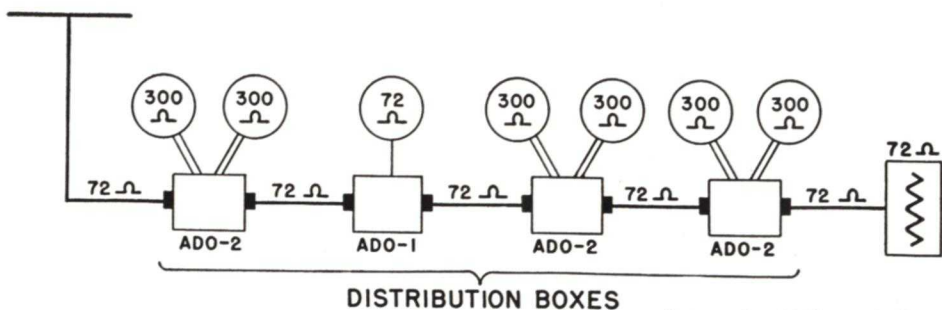

FIG. 30. A block diagram of the Jerrold Mul-TV antenna system intended for use in apartment installations. Either 72-ohm or 300-ohm receivers can be connected to this system. One or two sets can be connected to an ADO-2 box.

The choice of the antenna to be used with this master system depends upon the location. If several stations lying in different directions are to be picked up, it is usually best to use an individual antenna for each, aiming it for best pick-up and minimum ghosting. If all the local stations can be picked up well with one antenna, however, there is no need to use a separate antenna for each.

In an apartment-house installation, the use of an antenna system of this sort is very desirable. Not only does it furnish each tenant an adequate signal for his set on each channel, but also it practically eliminates interference between receivers. Its cost is fairly high but not excessively so, particularly if it is installed while the house is being built, since it is simple at that time to run the necessary distribution cable from one apartment to the next.

### DEALER INSTALLATIONS

Dealer installations may be divided into two categories. One is the installation used for demonstrating TV sets to prospective purchasers, the other is the kind that may be used in the service shop to assist the technicians in servicing TV receivers.

An installation that is to be used to demonstrate receivers to prospective buyers should be as good as it can be made. When a customer comes into a dealer's store to watch a television receiver, it should be working as well as possible. Many sales have been lost because of a poor demonstration caused by a slipshod installation. Every available local channel should give a good clear picture. It is not sufficient to pick up one or two

channels well and the rest poorly. The customer may appear willing to accept the explanation that this condition is due to the antenna, but inwardly he may think that the inability of the set to produce good pictures on all channels is due to some fault in the set. Even if he believes that the defective operation should be blamed on the installation, he will probably not have a high opinion of a serviceman who cannot make a satisfactory installation in his own store.

There is another reason why the antenna installation should be the best possible. It is easier to tune in a television set on a strong signal than it is on a weak signal. When the signal is strong and free from interference, there is little chance that the set will lose sync. Most customers like to operate a TV set themselves before purchasing it. If there is a strong signal available, they should be able to obtain a good clear picture very easily. This will impress them with the ease with which the receiver operates, which should be an excellent selling point for an aggressive salesman.

For these reasons, a master antenna system of the sort we just described is by all odds the best kind to use for dealer demonstrations. A small dealer, however, may not feel he can afford to install an elaborate system. In such a case, you can make a fairly inexpensive installation for him by using a single antenna and a distribution system like that shown earlier in Fig. 29 if his store is located in an area where the signal strength is high.

Before connecting two or more television sets to the same antenna, however, check the sets carefully to make

sure there will not be any interaction between them caused by radiation or feedback from their local oscillators. Incidentally, remember that sets having balanced and unbalanced inputs should never be operated together from the same antenna unless some device like the distribution boxes of the Jerrold antenna system is used.

If the signal strength is not high enough to make it possible to operate several sets at once from the same antenna, the arrangement shown in Fig. 31 can be used. Here all the sets are connected to the single transmission line through toggle switches. When one set is to be demonstrated, close the switch that connects it to the line, and open the other switches.

The antenna should be located as far as possible away from the street and from any electrical devices to reduce the noise pickup to the minimum. Shielded transmission line should be used so that there will be no line pickup from noise-producing devices or from radiation of the local oscillators in nearby TV sets or f.m. receivers. Noise coming in through the power line can be reduced to a minimum by installing power-line filters at the outlets to which the sets are connected.

The transmission line should be tacked neatly in place and kept as much out of the way as possible. If the transmission line is left lying around loose, not only will it appear unsightly, but also there is the danger that someone may trip over the line and be injured.

It is just as important to have a good antenna installation for a service shop as it is to have one for a dealer's showroom. The antenna must be capable of producing ghost-free

pictures on all available TV channels. This is important to you as a serviceman because ghosts can be caused by improper alignment of the TV receiver. If the antenna installation in the shop is a poor one that produces ghosts, you may attribute ghosts to the installation when they are really caused by improper alignment. If so, you will find that the ghosts are still present when you return the set to the customer, and all attempts to orient the antenna to eliminate them will be useless.

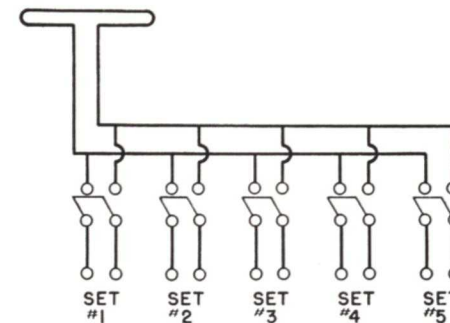

**FIG. 31. This multiple installation is designed to permit several different sets to be connected to the same line one at a time.**

Another reason for having a good antenna is that the customer will frequently come into the shop to look at his set. Sometimes a customer believes his set is defective when the real trouble is that he made the installation himself and failed to do it properly. If such a customer comes into your shop and sees the set operating properly, giving clear, sharp pictures on all available TV channels, it will be much easier to convince him that the trouble is due to his installation. On the other hand, if ghosts are present and the picture is poor in your

shop as well as in his own location, it's going to be rather difficult to convince him that his installation is at fault.

Again, a master antenna system like the one described earlier is the best kind to use in a service shop. If you do not want to use such a system for some reason, you should install two sets of antennas—a high-band-low-band folded dipole and a similar plain dipole. Use 300-ohm (preferably the

shielded kind to eliminate line pickup) for the folded dipole, and 72-ohm line for the plain dipole.

In either case, there should be connection terminals at various convenient points along the service bench. At each point, there should be a connection both to the 300-ohm balanced transmission line and to the 72-ohm coaxial line. This arrangement makes it possible to service either kind of set at any location along the bench.

## Lesson Questions

**Be sure to number your Answer Sheet 62RH-2.**

**Place your Student Number on every Answer Sheet.**

***Send in your set of answers for this Lesson immediately after you finish them, as instructed in the Study Schedule. This will give you the greatest possible benefit from our speedy personal grading service.***

1. When a leading ghost is caused by direct pickup in the front end of a set, what two steps should be taken to get rid of it?
2. Name two causes of tunable ghosts.
3. If a number of vertical bars appear on the face of the picture tube, is the frequency of the interfering signal (a) *lower than*, (b) *equal to*, or (c) *higher than* that of the horizontal sweep?
4. What kind of resonant circuit does a quarter-wave open stub act as?
5. If it proves impossible to eliminate f.m. interference on channel 2 by using a stub or a trap and re-orienting the antenna, what other remedy should you try?
6. If a carrier of the channel below the one to which the set is tuned causes interference, should you adjust (a) the sound trap, (b) the adjacent-channel sound trap, or (c) the adjacent-channel picture trap?
7. What kind of antenna should you use, even in a strong signal area, if ignition noise is a problem?
8. When interference from a TV set causes a nearby a.m. set to have birdies about every 15 kc., what circuits in the TV set are likely to be causing the trouble?
9. If the signal from one station is excessively strong at a particular location, how can you reduce its strength without affecting the response of the set for other stations?
10. If several sets are to be operated from the same antenna, but the addition of the extra sets reduces the signal strength too much, what two steps should you take before considering the use of a special master-antenna system?

**Be sure to fill out a Lesson Label and send it along with your answers.**



## Why Do You Want to Succeed?

There are several answers to this question. You may want to succeed for the very human reason that you want more money with which to enjoy life, or you may have a family for whom you want to provide those comforts they so well deserve—a home, a new car, good clothes, life insurance, and financial security.

Your ambition to succeed may be prompted by the desire to bring happiness to an aged father, mother or relative whose chief hope in life is to see you enjoy prosperity and prestige, to see you on the pinnacle of success.

Pause for just a minute and think—*what is your reason for wanting success?* With this reason in mind, resolve firmly that you will never allow your ambition to weaken. Resolve that you will never swerve from the direct path to your goal. Make this resolution now and keep it, so the years to come will be happier and more prosperous for you.

*J.E. Smith*