

# **MAINTENANCE OF P. A. SYSTEMS**

REFERENCE TEXT 62RX

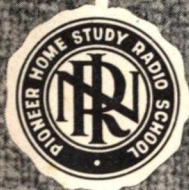

**NATIONAL RADIO INSTITUTE**

**WASHINGTON, D. C.**

**ESTABLISHED 1914**

# STUDY SCHEDULE

- 1. Introduction ..... Pages 1-2  
This section introduces the three sections that are to follow, and explains how these procedures differ.
  
- 2. Renovating P. A. Systems ..... Pages 2-14  
After a theoretical discussion of distortion, hum and noise, and oscillation, this section shows what practical steps may be taken to improve amplifiers having these defects.
  
- 3. Preventive Maintenance ..... Pages 14-17  
The steps taken in regular inspections that prevent many breakdowns.
  
- 4. Servicing P. A. Systems ..... Pages 17-28  
Practical service procedures for oscillation and motorboating, hum, noise, low output, dead systems, distortion, and intermittent defects.

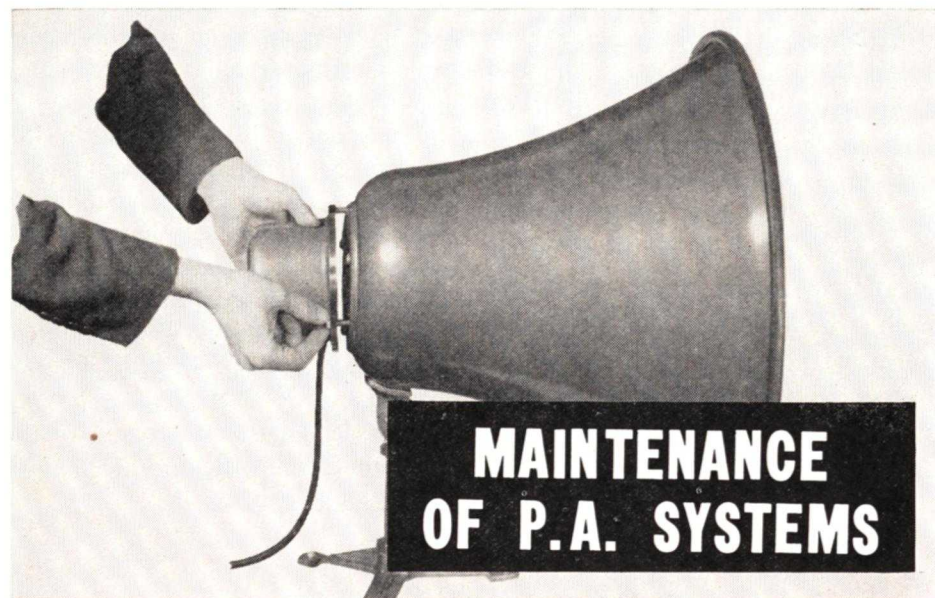

**P**REVIOUS Lessons have shown you how sound systems are planned and installed. Now we are going to discuss keeping sound systems in good condition.

This Lesson is divided into three sections. First, we shall discuss the renovation of existing equipment to improve its performance; next, we shall study preventive maintenance procedures that should be followed to keep a system from developing complete breakdowns; and finally, we shall learn how to service defective systems.

The need for renovation usually arises when new demands are made of the system. For example, it may be desired to play music over a p.a. system that was originally intended to carry only voice. In almost every such case, you will have to improve the frequency response of the system before it will be able to reproduce

music with good fidelity.

Natural aging may make equipment deteriorate to such an extent that it no longer gives satisfactory service even though it is not actually defective. Many consider the restoration of such systems to be a renovation, although it may also be classed as servicing if the final results are not better than the original response.

Preventive maintenance involves making frequent tests and inspections of a system as a matter of routine with the object of anticipating possible part failures and thereby preventing them from happening. The procedures followed in preventive maintenance often seem to be unimportant actions, since they consist mostly of inspecting components, shaking wires, removing dust, and so forth. Their value is proved, however, by the fact that a system stays in operating condition longer when these procedures are carefully followed.

*Photo above Courtesy Jensen Mfg. Co.*

Repairing defects in a p.a. system is much like repairing the audio system of a radio. As you will learn, however, there are certain defects that are more apt to occur in p.a. systems than in radios, mostly because a p.a. system is worked more nearly at its maximum level, so slight changes in tube characteristics or in operating potentials show up readily in reduced and distorted output. Also there are more connections between the amplifier and the input and out-

put devices, and each joint is a possible source of trouble.

We shall consider both true p.a. systems and office intercoms in this Lesson. Although the office intercom is really just one form of public address system, the fact that it is low powered and is intended to carry only voice makes the general procedure of maintaining it somewhat different from that usually followed for a p.a. system.

Now, let's discuss the renovation of inadequate p.a. systems.

## Renovating P. A. Systems

A p.a. system may distort, hum, be noisy, oscillate, or have insufficient volume without being defective in the sense that some part or parts have failed. Any one of these conditions may be bad enough (because of lower original design requirements) to require correction, particularly if greater demands are placed on the system than were originally made. Let's see why these conditions may arise, and what can be done about them.

### DISTORTION

The output of a p.a. system is distorted when it differs from the original input in any way except in a uniform change in volume. There are four kinds of distortion—amplitude, frequency, intermodulation, and phase. Phase distortion is not important in practical sound work, but any one of the other three may be present to an objectionable extent. We have

discussed these kinds of distortion in earlier Lessons, but, to refresh your memory, we shall describe briefly what each consists of.

Amplitude distortion is present if the shape of the output signal differs

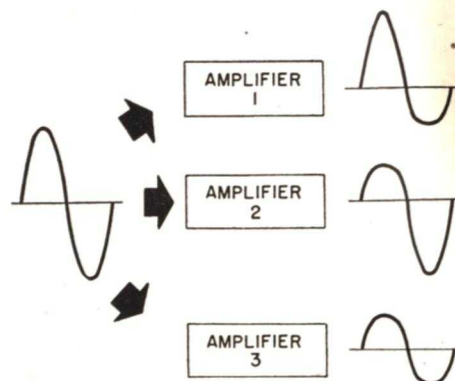

Amplitude distortion is present when the output signal of an amplifier does not have the same shape as the input signal. Here, for example, a sine wave is applied to three different amplifiers. Amplifier 1 clips the negative half of the input signal, amplifier 2 clips the positive half, and amplifier 3 clips both halves. In each case, the output of the amplifier is distorted.

from that of the input signal. In other words, if we feed a sine wave into a p.a. system and do not get a sine wave out, the system exhibits amplitude distortion. Amplitude distortion usually results in a flattening out of one or both half-cycles of the sine wave. This means, as you have learned, that higher frequencies have been added to the original signal. If only one half-cycle is distorted, even harmonics have been added; if both are distorted, odd harmonics have been added.

and difference of the two audio frequencies. It is similar to amplitude distortion in that extra frequencies are added; these added frequencies are not harmonics of the original frequencies, however. For example, if an audio frequency of 300 cycles and another of 700 cycles are applied to some non-linear device—such as a saturated transformer—beat frequencies of 400 cycles and 1000 cycles will be produced, as well as frequencies resulting from the interaction of these beat frequencies with one another and

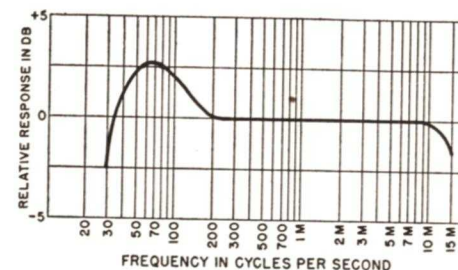

This is the frequency-response curve of a typical amplifier of fairly good characteristics.

Frequency distortion is present when some frequencies are amplified more or less than the other frequencies in the input signal. An amplifier that is deficient in high-frequency or low-frequency response, or which has a peak in its response, exhibits frequency distortion.

Intermodulation distortion might also be called audio-frequency superheterodyning. It occurs when two audio frequencies are fed into a non-linear device. The result is the same as that achieved when a radio signal and an oscillator signal are fed into the first detector of a superheterodyne; that is, beat frequencies are produced that are equal to the sum

with the original frequencies. These beat frequencies are not usually of great amplitude, but there are enough of them, when intermodulation distortion is pronounced, to cause fuzziness in the sound output. Intermodulation distortion is seldom measured for any amplifier, since there is no very easy way to measure it; in general, you can assume that a system having low amplitude distortion will also have low intermodulation distortion, although this is not true in every case.

A p.a. system exhibiting any one or any combination of these distortions may be satisfactory for some limited use, such as reproducing spoken words

only. However, such a system will almost invariably need renovating if it is to be used for music, since in that case the distortion will be far more noticeable.

**Amplitude Distortion.** Amplitude distortion may originate in the pick-up device, the amplifier, or in the loudspeaker, but its most usual source is in the amplifier. In fact, any amplifier has a certain amount of amplitude distortion. Therefore, the problem is not to eliminate amplitude

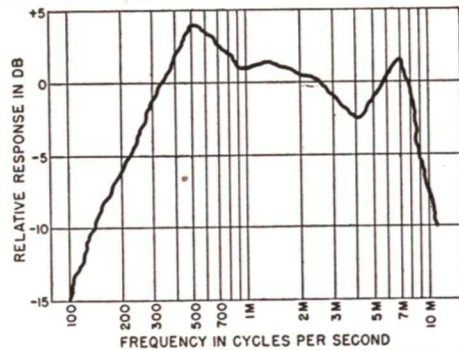

The frequency-response curve of a typical loudspeaker. Notice how much less flat it is than that of the amplifier shown earlier.

distortion altogether, but to reduce it so much that it is unobjectionable. A commercial amplifier of reasonably good quality usually has relatively low amplitude distortion if it is operated conservatively—that is, if its rated output is 20% or 30% more than the power actually drawn from it.

If you are renovating a system that exhibits excessive amplitude distortion, check first to make sure that the amplifier is not being asked to supply more output than it is designed to furnish. If it is, the only remedy is to install an amplifier that is easily capable of handling the load placed upon it.

In fact, whenever new demands make the amplifier of a sound system inadequate, about the only thing you can do is replace it with a better amplifier. We are assuming, of course, that the old amplifier is in good condition but is simply incapable of furnishing all the power needed.

Amplitude distortion may also be caused by a speaker cone that has become relatively inflexible. An old cone, or one that has been exposed to dry heat for some time, may have

this defect. The only cure is replacement of the cone or of the speaker.

**Frequency Distortion.** Frequency distortion may be caused by the pick-up device, by an audio line, by an amplifier, or by the loudspeaker. Each of these devices passes some frequencies better than others, even when it is in perfect condition, so the sound system may have marked frequency distortion without having any defective part.

You must always keep in mind the fact that the amplifier frequency response does not necessarily determine the fidelity of the sound system. Even if an amplifier has a perfectly flat frequency response throughout the

audio range, the sound system in which it is used may have severe frequency distortion if any of the other elements in the system has peaks or valleys in its response. Therefore, to secure high fidelity in a sound system, you must match the components so that the overall frequency characteristic has the desired shape. Usually it is best to design the system so that it is flat in response within reasonable limits for the desired range, but in some special cases it may be preferable to accentuate the lows or highs.

When you are attempting to improve a system that already exists, you do not usually have the freedom that the original designer had. The customer will generally expect you to make as few changes as possible to give the system the performance he desires. This means that, when a system exhibits frequency distortion, your efforts will be directed toward raising the valleys or lowering the peaks in the response as economically as possible. Very often this will mean that you will change a component of the system rather than attempt to improve its response, because the time cost of your work in making such an improvement would be more than a new component having the desired characteristic would cost.

Curves are very often used in discussions of the fidelity of sound systems. Such a curve usually shows how much db variation there is in the output of a sound system at different frequencies. To the p.a. man, however, these curves have only theoretical interest. As a practical matter, it is impossible to plot such a response curve for a complete installation. It

is possible to do so under laboratory conditions, using very elaborate equipment, but it is never done in practice.

These curves do have some valuable information to give you, however. For example, if a frequency response curve furnished by the manufacturer shows that the microphone to be used has a deficient low-frequency response, you know at once that the low-frequency response of the amplifier will probably need to be boosted to give a reasonably flat output. Similarly, if the manufacturer's information on the loudspeaker to be used indicates that it is deficient in response at one end or the other of the frequency range, you know approximately what change you should make in the amplifier output to correct for this condition.

However, curves that apply to general types of microphones or loudspeakers do not necessarily apply to specific microphones or loudspeakers that you may have. These curves are usually plotted for average values, and the equipment you have may not follow the average exactly. For that matter, even if the manufacturer used the particular microphone or loudspeaker you are concerned with in gathering the data for these curves, you have no guarantee that the characteristics of the device have not changed appreciably since the curve was drawn.

Therefore, the only practical use of such curves is to give the man who is designing the system some idea of how well the various components will match. If it appears from the manufacturer's information that the equipment to be used will give a reasonably

flat frequency response in combination, the chances are that only small adjustments will be needed to get the desired frequency response after the installation is made.

Fortunately, it is not necessary to make measurements of frequency response when you are renovating a sound system. The object of the system, is, after all, to produce an amplified sound that will be agreeable, or at least acceptable, to the ear. Therefore, you can check the performance of the system adequately simply by listening to it. If it sounds good, it is good—regardless of whether or not a measurement of the frequency response would show it to be perfectly flat. As a matter of fact, a system that has a certain amount of frequency distortion may sound better than does one that is theoretically perfect.

There is one major difficulty you will meet, however, in testing a system by listening to it. This difficulty arises from the fact that people differ in their hearing ability and preferences. Many prefer accentuation of the low frequencies in music, for example. Consequently, you may find that a customer doesn't like the reproduction a sound system gives even though you consider it excellent.

As a matter of fact, it is just about impossible to set up a sound system having a fidelity that everyone will consider satisfactory. Of course, extremely high fidelity is seldom required of a sound system unless it is to be used to amplify fine music for critical listeners. Installations of this sort are relatively rare, and usually highly trained sound engineers make

them. We can, therefore, forget the problems of extremely high fidelity and instead consider only the sufficiently large problems of producing acceptable frequency response.

The process of compensating for lack of uniformity in the frequency response of a sound system is called "equalization." Usually equalization involves increasing the low-frequency and high-frequency response of the amplifier to compensate for poor response in the microphone and loudspeaker at the ends of the audio range. Sometimes this can be done satisfactorily by adjusting the tone controls of the amplifier. This is possible, however, only if the system is well designed in the first place so that the components of it are reasonably well matched. If there are serious deficiencies in response in the microphone or the loudspeaker, or if the audio line connecting the various components discriminates excessively between frequencies, more elaborate correction is usually necessary.

A microphone may have weak low-frequency or high-frequency response or may have a peak at some frequency because of mechanical resonance. When this last defect is present, sound waves of the frequency at which the microphone is resonant will cause abnormally large mechanical motions within the microphone, producing an output with a relatively sharp, high peak. This defect is characteristic of low-priced microphones; the better grades contain damping arrangements that largely eliminate mechanical resonance. The only cure for a microphone that does exhibit excessive peaking from this cause is

to replace it with a better one. In some cases it is worth while to try a similar microphone in place of the one that is causing trouble, since there may be a considerable difference in their responses.

If a high-impedance microphone is used with a long microphone cable, there will be a very noticeable decrease in the high frequencies by the time the signal reaches the amplifier,

izers are made by several companies. Almost invariably, however, these are "losser" networks—that is, they compensate for a loss in high frequencies by reducing the low frequencies proportionately, or vice versa, with the result that the signal applied to the amplifier has the right proportion of highs and lows but is considerably weaker than the original output of the microphone. Such lossier equal-

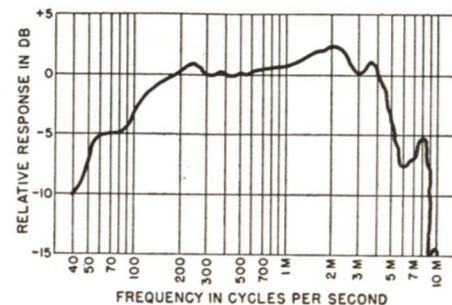

The frequency-response curve of a typical microphone. Like the loudspeaker, this microphone is far less flat in its response than is the amplifier. Remember that the overall frequency response of a p.a. system depends upon the responses of the individual components, not simply on the response of the amplifier alone. As a matter of fact, as you can see by examining the examples of amplifier, loudspeaker, and microphone responses given in this Lesson, the loudspeaker and the microphone vary so widely that it is they, rather than the amplifier, that determine the overall response.

because of the shunting effect of the distributed capacity of the microphone cable. For this reason, you should always use a low-impedance microphone and a low-impedance line when the microphone must be over 20 or 25 feet from the amplifier.

Weak low-frequency or high-frequency response, if it is not excessive, can usually be equalized by adjusting the tone controls of the amplifier. If not, you can insert an equalizer network in the line between the microphone and the amplifier. Such equal-

izers can be used only when the gain of the amplifier is great enough to overcome the attenuation they cause. Obviously, if the amplifier is working at its peak output, it cannot have sufficient reserve power to make up for the extra loss.

If the amplifier does not have enough gain to permit you to use an equalizer, probably the best way out is to use a better microphone—unless you intend to install a new amplifier anyway, in which case you may be able to get one having sufficient gain

to make the use of an equalizer possible.

Frequency distortion may also occur in the output system of the amplifier. Any one or more of these causes for frequency distortion may exist:

1. The loudspeaker may not be linear in its reproduction.

2. The baffle system used with the loudspeaker may cause a loss of the low frequencies.

3. The line-coupling transformer may cause losses at the high and low ends of the audio range and may possibly cause resonant peaks in the middle.

4. There may be loss of high frequencies in the line from the amplifier to the loudspeaker because of the distributed capacity of the line.

Frequency distortion caused by non-linearity of the loudspeakers can be minimized by using loudspeakers of good quality and efficient design instead of inexpensive and inefficient units. If fidelity is particularly important, separate loudspeakers may be used for the high frequencies and for the low frequencies. As you know, a combination of two speakers used in this manner is called a tweeter-woofer combination. Modern coaxial loudspeakers, in which the high-frequency tweeter is mounted within the cone opening of the low-frequency woofer, will give very extended coverage; the best will reproduce frequencies from as low as 30 cycles up to about 15,000 cycles with a minimum of frequency distortion.

Of course, it is useless to use an extended-range loudspeaker system

when the total range of the amplifying system is restricted. For example, if the amplifier system is capable of handling a range of 70 to 8000 cycles, a loudspeaker system that will reproduce from about 60 to about 10,000 cycles will give the system the utmost fidelity of which it is capable. There would be no point in using a loudspeaker system that had a more extended coverage than this.

When a tweeter-woofer combination is installed in this system, it is necessary to use a cross-over network with it to separate the highs from the lows and feed each to its proper loudspeaker. Most high-fidelity loudspeaker systems have such cross-over networks built into them; if not, the manufacturer almost always offers a suitable network separately.

It is practical to install better loudspeakers if the original ones are cone loudspeakers. If the original loudspeakers are exponential horns equipped with driver units, replacing them with cone-type loudspeakers is possible only if the consequent loss in sound power output is not objectionable.

There is usually a distinct loss in the frequencies below 250 cycles when horn loudspeakers are used. This makes them unsuitable for reproducing music when good fidelity is wanted. Folded auditorium horns will provide a greater frequency range but are not used very often, because they are large and expensive. Cone loudspeakers enclosed in suitable baffles offer a wider frequency range than any other kind of reproducer furnishes, and are therefore preferred for

faithful reproduction of music. They have several faults, however, mainly that they are limited in their power-handling capabilities and have low conversion efficiency. The fact that a cone loudspeaker has low conversion



*Courtesy Jensen Mfg. Co.*

**FIG. 1.** This is a typical bass reflex loudspeaker baffle. These come in three sizes to accommodate 8", 12", or 15" loudspeakers. The finished appearance of this baffle makes it suitable for installation almost anywhere without need for concealing it.

efficiency means that it must be fed considerably more power than must be applied to a horn loudspeaker to produce the same sound output. Since a single cone loudspeaker cannot handle much power, a great many of them must be used to get a high-level output.

There are various kinds of box baffles available for use with cone loudspeakers. Of these, the bass reflex baffle is the one most commonly used. A picture of one of these baffles is shown in Fig. 1. It consists of a wooden or fiber box that is closed on

all sides except the front, in which there are two holes. A loudspeaker is mounted in one of these holes; the other is a port from which emerges the sound waves caused by the movement of the back surface of the speaker cone. The baffle is designed so that the sound coming out of this port reinforces the bass.

Several manufacturers supply dual loudspeakers with matching cabinet baffles for use when high-fidelity sound output is desired. These are, of course, considerably more expensive than an ordinary wall loudspeaker. If it is necessary to use reflex trumpets because high efficiency of sound conversion is needed, it may be possible to get better low-frequency response by installing larger trumpets, which have longer air columns and

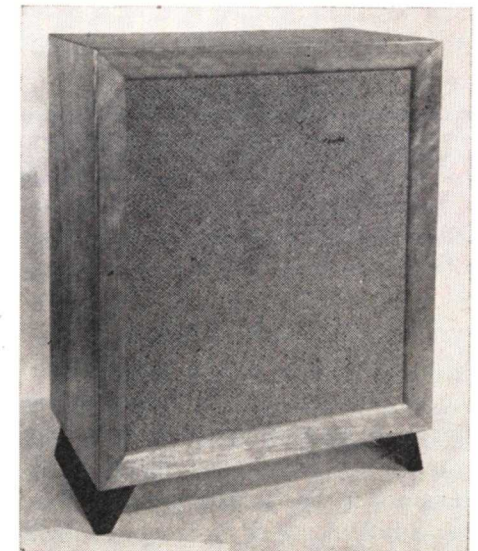

*Courtesy RCA*

This is another type of bass reflex baffle. Two loudspeaker units are used in it, one for high frequencies and one for low. The frequency range the assembly can reproduce in from 75 to 12,000 cycles, and its power-handling capacity is 20 watts. The unit can be stood on the floor, or the feet can be removed to permit wall mounting.

correspondingly lower cut-off frequencies. It is possible to get a reflex trumpet that has an air column of 6½ feet and a low-frequency cut-off of 85 cycles. A trumpet having a cut-off frequency this low is adequate for all but the most demanding installations.

An important cause of frequency distortion in the output section of a sound system is the coupling transformer used in the loudspeaker circuit.

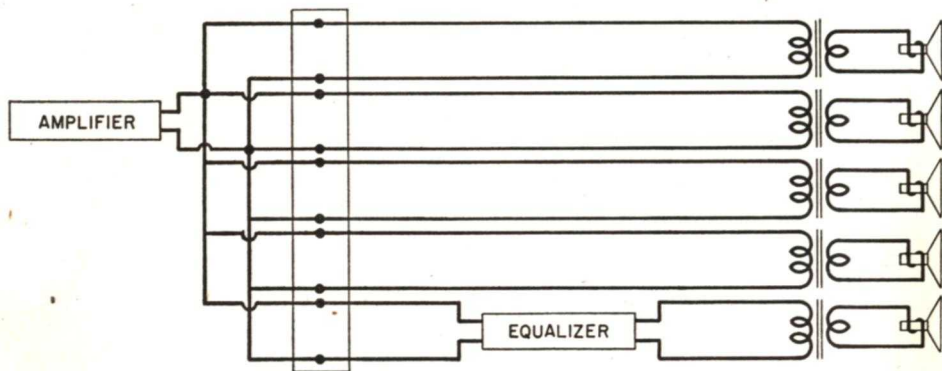

FIG. 2. An example of a loudspeaker system in which one line is equalized but the others are not. This is sometimes necessary, as the text points out, when one line is considerably longer than the others. They are all drawn the same length here because it is not customary to indicate actual line lengths on a schematic diagram of this sort; however, the presence of the equalizer in one line indicates that it is different from the others.

Unless it is of very good quality, this transformer may introduce losses at the high and low end of the audio band and may cause excessive peaking in the middle of the band. If an undesirable amount of frequency distortion is caused by the matching transformer, you must replace the transformer with a better one unless the adjustment of a tone control somewhere in the system makes it possible to remedy the distortion.

The output audio line going to the loudspeakers may also cause frequency distortion, just as the line

from the microphone to the amplifier does. If the amplifier has sufficient reserve power, some form of lossier equalization can be used that will attenuate the low and middle frequencies as much as the high frequencies are attenuated by the line, giving, as a result, a final output that is nearly flat. Such a method is particularly useful if the amplifier uses negative feedback in the output stage, and it is therefore not particularly critical

with respect to changes in the output circuit impedance.

When a parallel arrangement of loudspeakers is used, it is sometimes necessary to equalize the response of one but not of the others. This may occur, for example, if one loudspeaker is some distance from the others and therefore has a long audio line running to it (Fig. 2). The equalizer used will have very little effect on the amplifier load in such a case; its presence merely means that the impedance of one of the parallel branches is increased somewhat, and this, of course,

affects the net impedance of the parallel combination only slightly.

If equalization must be introduced in one of the lines of the parallel arrangement, however, it may be that attenuation will have to be introduced in the other lines to keep the outputs of all the loudspeakers at the same relative level. This may become necessary because of the power loss in the equalizer used in the line to the loudspeaker. The necessary attenuation can be secured by installing T pads in the lines of the other loudspeakers. These pads can be purchased commercially if you specify the db loss needed and the source and load impedances.

It is also possible that you may want to run the equalized speaker at a lower level than the others under some conditions. If the equalizer in the line does not reduce the output sufficiently, it may be necessary to use a T pad in the line also.

## HUM AND NOISE

Any high-power amplifier has a certain amount of hum. Since this hum is low in frequency (120 cycles if the amplifier uses full-wave rectification), it may not be audible if the amplifier is used with loudspeakers that have poor low-frequency response. Installing loudspeakers with better fidelity characteristics during renovation of such a system may actually make the system sound worse by making the hum more audible. (Also, changing speakers may result in more acoustic feedback, thus causing a howl.) Whenever you improve the low-frequency response of a system, therefore, be on the lookout for

an increase in hum. If it becomes objectionably noticeable, it may be necessary to improve the filter system of the amplifier, replace the power pack, or even install a new amplifier with a lower hum level.

Hum may also be produced during renovation if some unshielded part of the system is brought near a source of hum, such as an a.c. power line carrying heavy currents. Check over the installation to make sure this has not happened if the hum level is higher after a circuit change.

Noise in a system usually occurs only because there is some defect in the system. It is possible, however, that a change in microphones or in the conditions at the point where the microphones are may cause more noise to be picked up and reproduced than formerly. This may happen, for example, if you replace a sharply unidirectional microphone in a noisy location with one that has a more widespread pickup pattern. Choosing a microphone with a more nearly unidirectional pattern, or selecting some relatively noise-free location for the microphone, will clear up the difficulty.

## OSCILLATION

Oscillation may be caused in a p.a. system either by a defect in the amplifier or by acoustic feedback from a loudspeaker to a microphone. When you have had a little experience, you will usually be able to tell easily which kind of oscillation is occurring. Acoustical howling caused by sounds from the loudspeaker feeding back to a microphone is usually in the middle register—around 2000 or 3000 cycles.

Oscillation caused by a defect in the amplifier is usually either very low or very high in frequency. If you can reduce the microphone input to the amplifier to zero and still hear the oscillation, and the loudspeaker is not so near the amplifier that it is



Courtesy RCA

This is another type of bass reflex baffle. Two loudspeaker units are used in it, one for high frequencies and one for low. The frequency range the assembly can reproduce is from 75 to 12,000 cycles, and its power-handling capacity is 20 watts. The unit can be stood on the floor, or the feet can be removed to permit wall mounting. This is a dual loudspeaker having an unusually wide frequency response—50 to 13,000 cycles. It is used chiefly in locations where extremely high fidelity is wanted.

likely to be causing actual physical movement of a tube within the amplifier, you can be reasonably certain that the defect is in the amplifier circuits. This is covered elsewhere under repair of defects. However, acoustic feedback and the resulting howling may be such that renovation of the system is desirable.

There is almost always a certain amount of acoustical feedback in any p.a. system. Oscillation occurs when so much sound energy is fed back to the microphone that the production of sound by the p.a. system becomes self-sustaining. Suppose, for example, that a person speaks into a microphone over a public address system. A certain part of the amplified reproduction of the voice will be reflected back to the microphone. If the reflection is so strong that the volume level at the microphone of this reflected sound is as great as the volume level of the original sound, the amplifier will produce an output equal to the original output, and the process will be repeated over and over again. The result is that the p.a. system will produce a steady tone or howl, probably with a frequency between 2000 and 3000 cycles, because the overall amplification and feedback tend to "peak" in this range. As you can see, this is similar to the production of oscillation in an electrical circuit except that here the feedback is caused by the reflection of sound waves from the output to the input.

You can readily see that both the amplification of the system and the amount of acoustical feedback determine whether such howling will occur. If the amplification is high, even a small acoustical feedback can cause oscillation; or, if the amount of feedback is large, oscillation can occur at relatively low amplifications.

To control this kind of oscillation, therefore, either the amount of feedback or the amplification of the system must be reduced. It is easier, but

less desirable, to reduce the amplification—easier because doing so merely involves turning down the volume control, undesirable because doing so puts an upper limit on the output of the system. In renovating a system, you should reduce the feedback to such an extent that oscillations will not occur even when the system is operating at full volume. We shall discuss means of reducing feedback in a moment.

Howling can sometimes also be stopped by adjusting the tone control of the amplifier. It is quite possible that a p.a. system will have peaks at one or more points in the frequency range—that is, some frequencies will be amplified more than others. It is also possible that some frequencies will be fed back to the input more than others; high frequencies are more directional than low frequencies, for example, and may therefore be concentrated toward a wall from which they are reflected very readily, with the result that the sound reflected to the microphone contains more high frequencies than low frequencies. As we said, oscillations may occur if either the feedback or the amplification is too high. If the amplifier response is greater for some frequencies than for others, or if the feedback is greater for some frequencies than for others, those frequencies may cause howling even though all other frequencies do not. If the frequencies causing oscillation can be reduced by adjustment of the tone control, it will not be necessary to reduce the volume of the whole system to prevent oscillation. Like the reduction of volume, this method

of preventing oscillation is less desirable than is reducing the feedback, since it reduces the flexibility of the system. Hence, a correction of the frequency response may be the renovation step required.

**Reducing Feedback.** Assuming that the system does not have any loudspeaker pointing directly at the microphone, the ways to reduce acoustical feedback other than using different microphones or speakers are:

1. Move the speakers to a different location.
2. Move the microphones so that they pick up less feedback.
3. Reduce reflections in the room.

Most usually the latter is done by installing sound-absorbing material on the walls, floor, or ceiling. You learned in an earlier Lesson how acoustical material was used to reduce reflection in the room. Although we dealt with the matter there from the standpoint of the initial installation of p.a. systems, the principles apply just as well to a system that is already in existence.

Finally, the use of speakers having better back baffling and the use of modern microphones having controllable pickup patterns may both help to reduce the feedback.

## INTERCOM SYSTEMS

Fidelity, hum, and noise are not usually matters of concern in an intercom system as long as speech can be understood easily over it. In fact, about the only difficulties in an intercom network that require system correction rather than servicing are lack of volume and inflexibility of arrangement.



Both these difficulties occur only in systems that have been poorly designed from the start, or that have been modified after the initial installation in the hope of extending their usefulness.

The usual reason for a complaint of low volume in an intercom system is that a remote station having no built-in amplifier is placed too far from the master. In this case, signals from the remote station may be so attenuated that they are at or below the noise level by the time they reach the master, and therefore cannot be amplified sufficiently to be intelligible above the noise level. Signals from the master will still be audible at the remote location, however, unless the line is extremely long.

The only cure is to install a master or a remote having a built-in amplifier in place of the original remote station.

In a wireless intercom system, a station may no longer receive or transmit signals when it is plugged into a different power outlet. If this

happens, you can be reasonably sure that the new power output is not connected to the same branch as the other outlets used for the rest of the system. It is always possible that two outlets in the same room are not both on the same power branch, particularly in a large office building that has several main power lines. This complaint can be remedied rather simply by plugging the intercom into an outlet that is connected to the other outlets used for the system.

A part of a wireless system may transmit or receive poorly, or even fail to do so altogether, if it gets out of alignment. We will discuss the realignment of wireless intercoms later, in the section devoted to servicing.

If the system no longer provides the number of intercom stations that are desired, the renovation consists of adding the required units and using master units having the required number of switch positions.

Now, let's study the preventive maintenance procedures.

## Preventive Maintenance

Preventive maintenance is a procedure carried on for the purpose of preventing trouble by anticipating it. In p.a. work, it consists of regular, frequent inspection and testing of the equipment and the installation. Such work is generally done under a service contract, under the terms of which a serviceman agrees for an annual fee to make periodic inspections and to service whatever defects he finds. This

fee may or may not include the cost of replacement parts—usually not, since the fee would have to be prohibitively high to take into account such possibilities as the failure of a large and expensive loudspeaker.

Preventive maintenance, if it is properly carried out, is extremely good insurance against breakdowns. To carry it out properly, however, you will have to develop an ability

to notice little defects in performance or operation that are advance indications of future part failures. Much of this ability will come with experience. It is easy enough for any one to tell whether a resistor is hot, for example, but you must have had considerable experience in maintenance work before you can decide whether it is so hot that it will burn out quickly or is just operating at a high but safe temperature that it can maintain for a long time without damage.

### MAINTENANCE PROCEDURE

The most important step in preventive maintenance is to set up a good maintenance procedure. The procedure will depend to some extent in its details upon the specific installation, but the main features of it should be about the same for all installations. We shall, therefore, discuss the basic principles you should follow in any preventive maintenance work.

There are three things you should do on each of your periodic visits to an installation you are maintaining: You should listen to it, inspect it carefully, and make various instrument tests on it. Let's see what you can find out from each of these actions.

**Listening Tests.** Naturally, the first thing you should do when you make a service call is to ask the user of the equipment if there is any complaint. If he feels that the system has been performing poorly in any way, keep his remarks in mind as you go through your maintenance procedure. Whether or not he has any complaints, you should be on the alert

to spot any possible causes of trouble.

Next, turn on the equipment and listen to it carefully. Listen to each of the loudspeakers to make sure that none of them is excessively noisy and that the hum level is not abnormal. If you find no such defects, run the volume and tone controls quickly up and down several times to see if doing so causes an excessive amount of noise. A noisy control should be re-

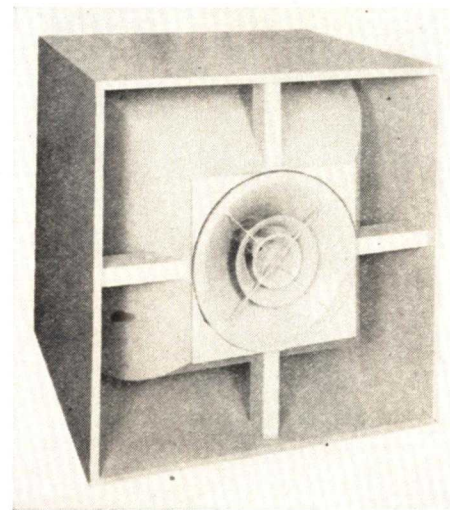

*Courtesy RCA*

This loudspeaker-baffle combination is designed for installations in which both high power and high fidelity are required. The unit has a frequency range of 50 to 11,000 cycles and is capable of handling powers up to 40 watts. As you can see, two coaxial loudspeaker units are used. These are powered by diaphragm-driven units.

placed, since it will usually get worse very soon.

Having tested the system for background noise and hum, your next step should be to try it out in operation. Have an assistant speak into each microphone and operate each record player while you listen carefully to the output of each loudspeaker. After you have had some experience, you

can detect increases in distortion or loss in output that indicate the possibility of major defects in the future.

**Inspection.** While you are making your listening tests, you should also inspect the installation carefully.

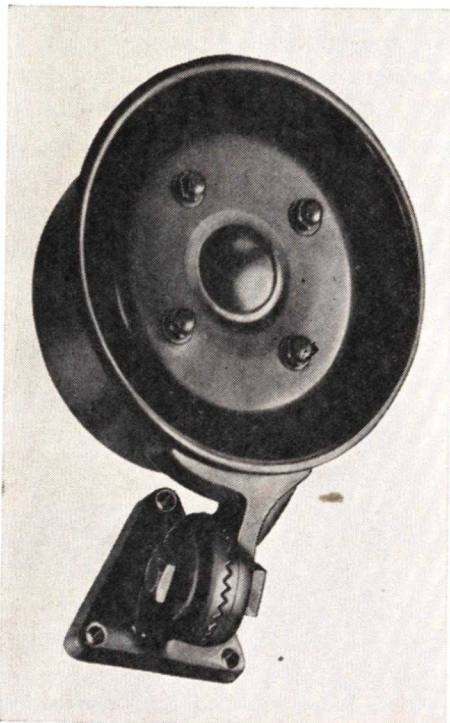

*Courtesy University Loudspeakers, Inc.*

This is the University type MM-1 loudspeaker, a splash-proof marine unit that is unusually small. It has a continuous operating capacity of 8 watts. Its sealed construction makes it suitable for use in either wet or dusty locations.

Look over each loudspeaker while you are listening to it and make certain that it is firmly secured and that the cables going to it are in good condition. If a plug connection is made to the loudspeaker, make sure the plug is firmly seated. See that the shields in the loudspeaker cables make a good connection to ground.

Inspect the shielding on all other

cables also. Make sure that the connections at both ends of each cable are firmly made. See that the knobs of all controls fit tightly on their shafts and that pointer knobs do not rub on their dial plates.

To make the instrument tests described a little later, you will have to open up the amplifier to some extent. When you do so, inspect all visible parts of it carefully.

See that the tubes are firmly seated in their sockets, that all shields are in place, that all soldered connections are good, and that all components appear to be in good condition. Dust out the amplifier case. Make sure all grid-cap connections are tight. In brief, use your eyes intelligently and carefully to spot any possible cause of trouble.

**Instrument Tests.** The most important single test on the system for you to make with instruments is a check of the tubes. This should be done each time the system is inspected. You should discard any tube that appears to be questionable. Tubes are one of the most common causes of trouble in an amplifier, so it will pay you to make a careful check.

You should also make certain voltage measurements as a matter of routine. On each service call, you should measure the output of the power supply and compare it with the reading secured on the last call. If there is a significant difference in the readings, you should discover the cause. Every now and then, also, you should make readings of the plate voltages of all tubes. How frequently you should make these voltage readings depends on the amount of use the

p.a. system gets. If it is in fairly constant use, plate voltage readings should be made every three months or less; if it is used relatively infrequently, six-month or even one-year intervals may be frequent enough. Plate voltage readings will be helpful, of course, only if you have other readings with which to compare them. Therefore, you should record all such readings and compare them with those taken previously to see if you can observe any marked change that indicates the possibility of future trouble.

While you have the amplifier opened up, you should, as we said earlier, make a visual inspection of all parts that you can see.

### SERVICE PROCEDURES

The discussion we have just given of preventive maintenance procedures makes no mention of the possibility of your finding defects. Naturally, when you find a condition that indicates the possibility of a defect, you must check back through the circuit or part involved to see what might be causing the condition. If you find the hum level has increased, for example, the most probable causes are that cathode-to-heater leakage has developed in a tube or that the filter condensers are losing capacity. Cathode-to-heater leakage should show up when you test the tubes, but may not if the leakage is slight or your tube tester is not well designed for the test. You can check the filter condensers by disconnecting them and

testing them with a condenser tester, if you have one, or, if not, by temporarily connecting a filter condenser you know to be good in place of the one you suspect. These, of course, are servicing techniques, which we shall



*Courtesy RCA*

This illustrates one way of suspending a microphone so that it can be raised or lowered easily. Suspensions of this sort are frequently used in boxing and wrestling areas to hold a microphone over the ring. When you inspect an installation of this sort, make sure that the microphone is supported only by the ropes and not by the microphone cable.

discuss in the next section of this Lesson.

As a matter of fact, preventive maintenance becomes servicing as soon as you find any indication of an actual or possible future defect in the system. Now, let's see what techniques are particularly useful for servicing p.a. systems.

# Servicing P. A. Systems

A public address amplifier is essentially the same thing as the audio amplifier of a radio, except that it usually has much higher power, and the servicing techniques used for the one are not much different from those used for the other. In our discussion of p.a. servicing, therefore, we shall make use of the knowledge you've already gained about the servicing of radios.

The most common defects of p.a. systems are oscillation or motorboating, hum, noise, low volume, no output, distortion, and intermittent operation. (These are not necessarily arranged in this list in order of relative frequency of occurrence.) Naturally, to service a p.a. system exhibiting any of these defects, you should isolate the defective stage, circuit, and part with the aid of the servicing techniques you have already learned. To assist you to do so, we shall now discuss each of the defects a p.a. system may be expected to exhibit and point out the most common causes for each.

Before we go any farther, we want to give you a word of caution. *Never disconnect a loudspeaker from an amplifier while it is in operation.* If there is only one loudspeaker in the system, disconnecting it while the amplifier is operating may ruin the output tubes because the removal of the load will cause a very high peak voltage to appear across them. If several loudspeakers are used, disconnecting one may cause the others

to be overloaded and damaged. By the same token, you should never turn on an amplifier without making certain that the output stage is properly loaded.

In addition, don't try to operate a system with the speaker driver unit out of the horn or baffle. The lack of proper loading on the cone or diaphragms permits overdriving, which results in a ruined cone or diaphragm.

## OSCILLATION AND MOTORBOATING

Oscillation in a p.a. system can be caused either by acoustical feedback of sound from the loudspeaker to the microphone or by a defect within the amplifier. We discussed acoustical feedback in the first part of this Lesson, since it is not really a service defect.

Correcting oscillation caused by a defect within the amplifier is done with the aid of the same methods you'd use to correct a similar defect in an ordinary radio. Oscillation in an audio amplifier usually takes the form of motorboating (oscillation at a very low frequency). Its most usual cause is a defect in a filter or by-pass condenser that causes an increase in gain or permits greater feedback. A condenser that is open or has lost capacity or has an increased power factor may cause oscillation. Any defect that changes bias, screen, or plate voltages so as to increase the gain of the stage may also cause

oscillation, but is not as apt to do so as is a condenser defect.

## HUM

Hum in a p.a. system is most usually caused by a defective filter condenser or by cathode-to-heater leakage in a tube. In some amplifiers, hum may also become evident if the output stage becomes unbalanced because of differences in the characteristics of the tubes. This can happen, of course, only in an amplifier in which the balanced characteristic of

ing is a poor, high-resistance contact between the amplifier and the plug at the end of the shielded cable.

Hum may also be picked up directly by a microphone that is near some device that hums. Even an electric clock has been known to cause enough hum to be picked up and amplified by a microphone located near it.

## NOISE

Noise is another condition that may be caused by something completely separate from the p.a. system. For

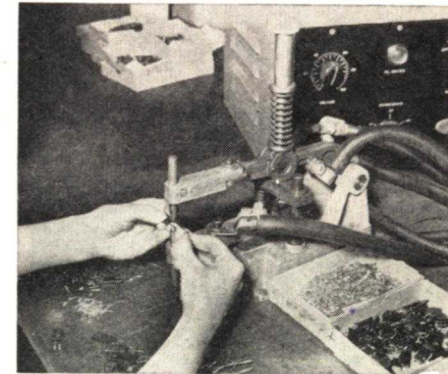

*Courtesy The Astatic Corp.*

In a microphone factory, the leads of crystal microphones are spliced by spot welding. This procedure, which is very quick, does not heat up the crystal enough to damage it. It is easy to get a crystal hot enough to ruin it, however, if you attempt to solder the leads, because the soldering iron must be held against the leads for an appreciable time.

the output stage is depended upon to remove some hum.

Hum in the output of a p.a. system may also be caused by pickup from external sources. Microphone and loudspeaker cables are supposed to be completely shielded; if a poor connection develops between the shield and the amplifier chassis, however, hum may be picked up. Perhaps the most common cause of faulty shield-

example, a customer may complain that there is a great deal of noise in the system when one of his favorite records is played over it. You can almost be sure when you hear a complaint of this sort that the record has simply been played too often and is noisy. The system itself, of course, is not to blame, unless noise is present all the time.

The customer may also complain that

the system is noisy when the noise is actually picked up by the microphone. This, too, is a condition that cannot be blamed upon the system.

You yourself would not be likely to make a mistake in diagnosis of the difficulty in either of these cases. Remember, however, that the owners and users of p.a. systems are not necessarily technical men, and they often have a marked tendency to blame every difficulty upon the system instead of looking for possible outside causes.



*Courtesy The Astatic Corp.*

At the factory, skilled technicians inspect damaged microphones minutely, using special equipment like the microscope shown here. A microphone is too delicate a piece of equipment to be pryed into by someone who does not know exactly what he is doing.

There are many defects that can cause noise in a p.a. system. A defective tube is a frequent offender, particularly one that has loose elements that may intermittently short-circuit if the tube is vibrated. A noise resulting from this cause usually consists of a loud crashing sound that occurs only at intervals.

A more or less steady, roaring sound may be caused by an open grid circuit in a voltage amplifier

stage or by an open input circuit. Noise results from a defect of this sort because the grid of the amplifier stage is then able to "float"—that is, it develops a very high impedance to ground. Even very small noise currents developed through this impedance will produce an appreciable grid signal. This trouble may be caused by a poor connection at a microphone cable plug such that the cable shield does not ground satisfactorily to the amplifier chassis.

Noisy operation is often caused by

defective faders or variable attenuators. You can determine whether a control is defective by adjusting it throughout its range at varying rates of speed. If you hear a crashing noise when you do so, the control is at fault.

If you hear a rattling noise from the cone loudspeaker, the chances are that the cemented edge of the cone has come loose. It is, of course, easy to determine whether or not this has

happened by inspecting the loudspeaker. If you are within the range of two loudspeakers, however, it is often rather difficult to tell from which the sound is coming. The easiest way to do so is to reduce the volume until you can hear a loudspeaker only when you are very close to it; unfortunately, doing so may mean that the loudspeaker will be driven so little that it does not rattle appreciably even though it is loose. In this case, disconnect one of the two loudspeakers from the amplifier. (Of course, the amplifier should be turned off before you do so.) Operate the system then at a fairly high volume level to be sure that rattling will occur if the cone is loose. Do not, however, allow the volume level to become so high that the loudspeaker will be overloaded; remember that there is now more power available because the other loudspeaker is disconnected.

With the loudspeaker removed, there will be an impedance mismatch at the output of the amplifier that may cause distortion. Pay no attention to the distortion, since it will be removed when the proper impedance match is made again.

## LOW OUTPUT

Low output in a p.a. system may be caused by any of the defects that cause the audio amplifier section of a radio to be weak. In addition, there are some defects that may be found in a p.a. system that you would not ordinarily find in a radio. For example, many of the more complicated p.a. systems have terminal boards to which the leads from the loudspeakers

are brought. It is always possible that one of the connections in this terminal board has become poor, either through corrosion or through someone's accidentally having loosened it. There may also have been some mechanical injury to one of the loudspeaker cables that broke some of the strands of wire in the cable and so increased its resistance considerably. The loudspeaker itself or the input device may also be to blame. Later on, in a section on microphones, we shall discuss some of the defects that may cause the microphone output to be reduced.

Remember, also, to look for some very obvious cause of reduced volume, such as a failure by the user to adjust the volume control correctly.

In an installation in which multiple speakers are used, a defect that causes a short circuit or partial short circuit across the line to one loudspeaker reduces the overall volume output of the system for two reasons: first, because the output from the shorted loudspeaker is lost, and second, because the impedance of the speaker combination is changed, causing a mismatch that wastes power. You can locate a defect of this kind by listening carefully to each loudspeaker to determine which has the lower output.

If a great many loudspeakers are used, it is sometimes helpful to disconnect them all from the amplifier and feed a signal from some other source, such as a signal generator, into each line individually to determine which one is at fault.

## DEAD SYSTEM

When you receive a complaint that

a p.a. system is dead, your first step should be to make sure that the amplifier is plugged in and that the power is turned on. It is surprising how often such a simple and obvious cause for a dead system is overlooked by the owner.

Next, if the system has multiple inputs, check each of them. Some-

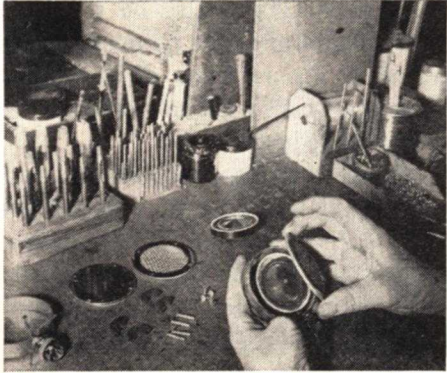

*Courtesy The Astatic Corp.*

**Precision and care are required to reassemble a microphone after it has been repaired. The man who does so must be experienced if he is to do a good job.**

times the user of a p.a. system will assume that the whole system is dead when he gets no response from one input. If all inputs are dead, the trouble is in the amplifier or in some common connection to the loudspeaker system. If only one input circuit is dead, the defect must be in the preamplifier channel employed for this input device, in the input device itself, or in the cables connecting it to the amplifier. The easiest way to tell which is to blame is to try another input device (microphone or phono pickup) on the input terminals of the defective channel. If the test device works, then the original device or its cables

is to blame. In this case, apply a test signal to the cable with the input device removed; if the system then operates properly, the original input device must be defective. Incidentally, it would be a good idea for you to include with your servicing equipment a test microphone that you know is in good condition, a record player, and perhaps an audio oscillator, for use when you want a test signal source.

If all the input circuits are dead, check the connections between the amplifier and the loudspeaker. If the loudspeakers appear to be connected properly to the amplifier, very likely the amplifier itself is defective. You can then follow the usual service procedure to locate the defective part. If the amplifier has a fuse, check it first before looking for other components that may be defective. If you do find that a fuse is blown, install another and then operate the amplifier for a reasonable length of time to make sure the fuse does not blow again. If it does, there is some other defect in the amplifier that you must locate. If, however, a replacement fuse does not blow within about five minutes, check the leakage of the filter condensers and the plate voltages of all tubes. If the filter condensers are not excessively leaky, and the plate voltages are not above normal, it is unlikely that there has been any long-time overload that has caused the fuse to blow. In this case, you can assume that some defect of a temporary nature, such as a power surge on the line, caused the original trouble.

If the fuses in a given place

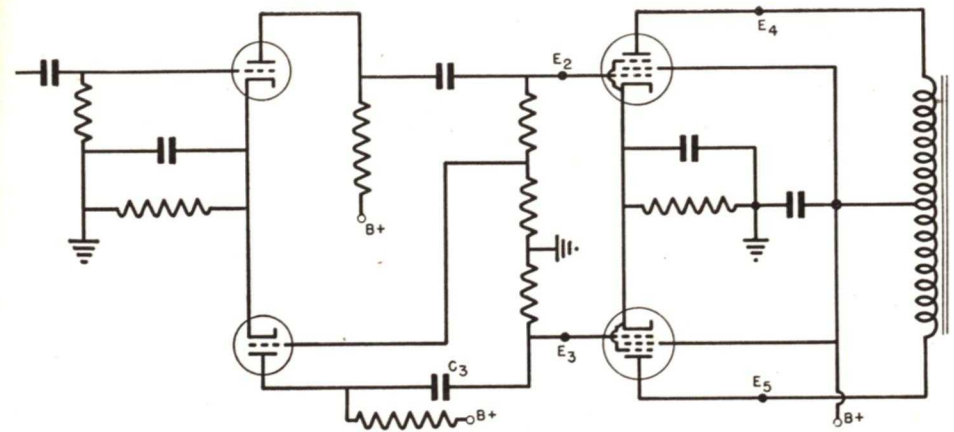

**FIG. 3. Typical output stage of a p.a. amplifier.**

blow rather frequently, you should check the line voltage to make sure that it is not excessively high. If the line voltage is above 130 volts, report the fact at once to the power company, because there is very possibly some defect in the power line itself. If the line voltage is slightly under 130 volts, the chances are that the amplifier is a little too sensitive to supply voltage variations, although it would work perfectly well in the usual supply voltage range of 110 to 115 volts. In such a case, you should consider installing a voltage-dropping resistor in the supply line to the amplifier if it appears that the high line voltage is to be present constantly. If you do use such a voltage-dropping resistor, be sure that its dissipating ability is sufficient for the power it must handle.

## DISTORTION

We mentioned distortion earlier in the section on system renovation. Since we described there the defects outside the amplifier that might cause

distortion, we shall deal here only with the internal defects that may cause a system to distort.

Distortion may be caused in a p.a. amplifier by any of the defects that will cause distortion in the audio amplifier of a radio. In addition, an unbalanced output stage, which would usually cause relatively little distortion in a radio, will produce very appreciable distortion in a p.a. amplifier because of the high power levels in such equipment.

Fig. 3 shows a typical output stage in a p.a. system. Any defect that could cause an unbalance in this stage could cause distortion. If condenser  $C_3$  were to open, thus reducing the signal fed to one of the output tubes, the output of the amplifier would be very much distorted because of the loss of push-pull action. There would also be a loss in volume, although this would not be noticeable until the volume control was turned well up; at low volume levels, either output tube could supply sufficient signal.

A vacuum tube voltmeter can be used to determine how well the out-

put stage is balanced. While a test signal is applied to the input of the amplifier from a sine-wave audio generator, measure the voltages between the circuit components and ground at the points marked  $E_2$ ,  $E_3$ ,  $E_4$ , and  $E_5$  on the diagram. If the stage is well balanced,  $E_2$  should equal  $E_3$ , and  $E_4$  should equal  $E_5$ .

An oscilloscope is also a useful instrument when you are trying to locate the source of distortion. The method of using the oscilloscope for this purpose was described earlier in your Course.

Again, the use of multiple pickups and loudspeakers gives a p.a. system possible sources of distortion that do not exist in a radio.

If a p.a. system uses two or more pickup devices and two or more loudspeakers, you will be able to localize the source of the distortion rather easily. If the distortion is heard when one microphone or record player is used but not when the other is used, then almost certainly the source of the distortion is in the first device. Similarly, if the distortion is heard on one loudspeaker and not on others, then the one on which it is heard must be defective. If the distortion is the same regardless of which pickup device or which loudspeaker is used, the amplifier is probably to blame.

### INTERMITTENT DEFECTS

A p.a. system is subject to all the intermittent defects that the audio system of a radio has. Going dead intermittently is probably the most common defect, but any of the others we have described can also occur intermittently.

Loose connections, frequently the cause of intermittent defects, are more common in p.a. systems than in radio receivers. One reason is that there are usually many more connections of the sort that are frequently made and broken in a p.a. system—connections to loudspeakers or microphones, for example. Such connections are naturally much more likely to become defective.

Most intermittent defects have only one symptom: That is, a system hums intermittently, or goes dead intermittently, but does not do both. Occasionally, however, a system will have dual defects—for example, an intermittent loss of output accompanied by distortion. This is usually caused by a voice coil circuit that opens intermittently. If the voice coil is slightly off-center, it may rub against the pole piece enough to wear off the enamel insulation from the coil wire; the coil may then short circuit intermittently to the pole piece and, through it, to the voice coil terminal that is grounded to the frame of the loudspeaker. This is much the same thing as putting a short across the secondary of the coupling transformer feeding the voice coil. As a result, the output from the defective loudspeaker is reduced or killed completely. The changed impedance of this loudspeaker will also destroy the impedance match between the amplifier and the loudspeaker system, and will therefore probably reduce the output of all the loudspeakers to some extent.

Even though the output of each loudspeaker will be reduced by such

an occurrence, the output of the defective loudspeaker will be affected by far the most. Therefore, you can locate the defective loudspeaker by listening to each of them and determining which is the worst. This may, of course, be difficult if the intermittent operation occurs for only a short period of time.

If you have a sensitive ohmmeter, you can check the suspected loudspeaker rather easily. All you need

matching transformer is removed from the circuit.

Alternatively, you can open the voice-coil circuit and place the ohmmeter in series with the voice-coil transformer and the voice-coil. In this case, the resistance you measure will be slightly higher than that of the voice-coil. Whatever method you choose, the indication of voice-coil trouble is a change in resistance as the voice-coil is moved.

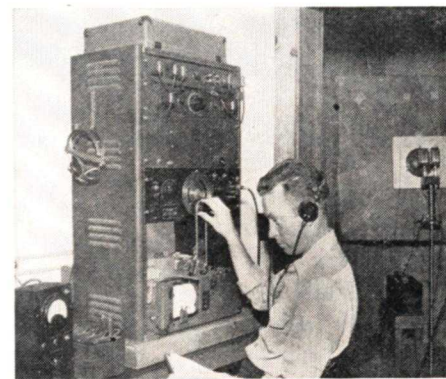

*Courtesy The Astatic Corp.*

Highly specialized equipment is needed to calibrate a microphone after it has been repaired. This picture shows a calibration run being made on a microphone at the Astatic factory. Don't attempt microphone repairs yourself—send the microphone back to the manufacturer.

do is measure the resistance of the voice coil circuit and see whether it changes when the voice coil is moved in and out. You will need a good ohmmeter to do this, since the resistances involved may be of the order of 1 ohm. If the ohmmeter is not quite this sensitive, you can disconnect the voice coil from the output transformer and measure the voice coil resistance alone. Doing so lets you measure a somewhat higher resistance, since then the very low resistance of the secondary of the line-

### ALIGNING A WIRELESS INTERCOM

As you recall, a wireless intercom uses the power line as a means of propagating a modulated carrier signal. The carrier frequency on most is around 100 kc. This frequency can be changed up or down by a factor of 25% so that as many as three systems can be used near one another without interfering with each other. For example, the units in one system may be tuned to 120 kc., the units in the second system to 100 kc., and

those in the third to 80 kc. Since all three carrier signals will be present in one power line, it is necessary for each unit to accept a bandwidth considerably less than 20 kc. to make sure it will not pick up a carrier that is not intended for it.

It is easy enough to align a wireless intercom to a specified frequency if you have a signal generator. Simply connect the signal generator to the input of the intercom, set the generator to the desired frequency, and turn the tuning trimmer condenser until you get a maximum response. (Most wireless intercoms use trimmer condensers to tune their input circuits.) Tune the other unit of the pair in exactly the same manner. Then, check your work by transmitting from one unit to the other and back from the second unit to the first. While one unit is operating, make small adjustments of the trimmer on the other to make sure that you have the point of maximum response. Do not adjust both units, however, since doing so may get you too far away from the frequency you want.

If you do not have a signal generator when you are attempting to align a wireless intercom, you can probably do a satisfactory job by turning the trimmers on both units all the way in, backing both off a quarter of a turn, and then adjusting one unit for maximum response while someone talks steadily into the other unit. When you have peaked one unit in this manner, reverse the procedure and peak the other while someone is talking into the one you have already adjusted. If you wish to add another system, turn the trimmers on both

units on that system until they are a quarter of a turn from being all the way out and repeat the tuning procedure. Finally, if you wish to add a third system, set the trimmers of the two units half-way between the full-in and full-out position and again repeat the tuning procedure. In each case, be sure that you make only small adjustments during the alignment procedure so that you will stay fairly close to the point at which you initially set the condensers.

### MICROPHONES

Microphones are extremely delicate devices and must be handled with great care. In fact, it is almost impossible for you to service one successfully unless you have had some special training in this delicate work. It is not even possible to test them successfully without special equipment. Therefore, never open a microphone on the assumption that you can poke around in it, find out how it works, and fix it. If the microphone is dead, return it to the manufacturer for repairs.

As a matter of fact, it is impossible to make a direct test of a microphone without special equipment normally used only in factories. About the only practical test that a serviceman can make is to install a microphone he knows to be good in place of one that he suspects of being defective. If the response of the system improves when the good microphone is installed, then either the original microphone is defective or its matching transformer and connecting cable are defective. Of course, the test microphone you install should be of the same type as

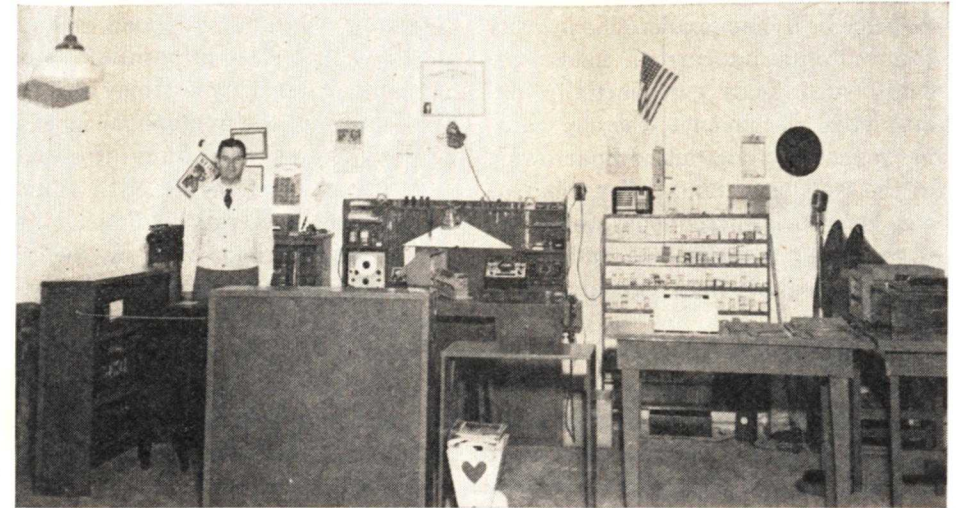

This is the service shop of an NRI graduate who does p.a. work as a sideline. Notice the trumpets and microphone at the right of the picture.

the one of which you are suspicious.

It is possible to test the microphone cable for continuity, but the microphone should be disconnected from the cable before you make such a test. An ohmmeter must never be connected to a microphone, because even the relatively small d.c. voltage of an ohmmeter can damage certain types of microphones severely or even ruin them.

Substitution of a good microphone is the only way you can tell whether or not a suspected microphone is deficient in its frequency response or in its output. These qualities of a microphone are tested by the manufacturer, but the method used is not practical for a serviceman. At the factory, the microphone under test and a standard test microphone are placed in a room that has had special acoustic treatment. Pre-determined amounts of sound power at various frequencies are then fed into both microphones, and the outputs of the two are com-

pared as to amplitude and frequency response. No method that is less elaborate has been discovered for checking microphones accurately.

As you can see, a microphone that is bad is not something you can service. There are, however, certain practices that you can follow that will extend the useful life of microphones. We shall tell you what they are, and you can pass along the information to the owner of a p.a. system so that he can make his microphones last longer.

**Microphone Precautions.** Every velocity or dynamic microphone has a powerful magnet built into it. For this reason, none of these microphones should be placed on a workbench or any other place where it might pick up iron filings. The housing contains a metal screen around the diaphragm of such a microphone to prevent bits of metal from entering it, but iron dust or very small filings can work their way in if given a chance.

Care should be taken to keep any velocity or dynamic microphone away from alternating current fields, because such fields can partially demagnetize the magnet, thereby causing reduction in output and narrowing of the frequency range. For this reason, keep such microphones well away from power transformers and power lines, particularly lines carrying heavy current.

Velocity microphones of the ribbon type, which are normally used only when extremely high fidelity of pick-up is required, are very delicate. They must be handled with great care. For example, they should always be carried or moved in a normal operating position—that is, held upright so that the ribbon is in a vertical plane. Carrying such a microphone horizontally lets the ribbon sag and stretch. Any jarring or rough handling may cause the ribbon to move so far that it will be stretched out of shape or stick to one of the magnets between which it is suspended.

The magnets of a velocity microphone may themselves shift in position if the microphone is jarred or roughly handled. The location of these magnets with respect to the rib-

bon is very important to the proper operation of the microphone, so even a very slight shift in position of one or more of the magnets may destroy the fidelity of the microphone or even prevent it from operating altogether.

A strong blast of air on a ribbon microphone is certain to damage the ribbon and perhaps ruin it. Such a microphone must, therefore, be well protected from the wind if it is used outdoors. No one should be allowed to speak into it from very close range. In particular, you should never whistle directly into a ribbon microphone to test its operation.

The crystal unit in a crystal microphone can be damaged by heat, excessive humidity, or mechanical jarring. Therefore, such microphones should be kept away from extreme heat and dampness and should be kept out of direct sunlight as much as possible. They should be protected, also, from excessive shock and vibration.

Let us repeat one important warning. *Do not try to repair a microphone; return it to the manufacturer for repairs.* It is almost invariably less expensive to have a microphone repaired than to buy a new one.





## THOUGHT

Many years ago, Carlyle wrote this tribute to *thought*—to men who think—to institutions which help men think:

“How noiseless is thought! No rolling of drums, no tramp of squadrons or immeasurable tumult of baggage-wagons, attends its movements. In what obscure and sequestered places may the head be meditating, which is one day to be crowned with more than imperial authority. It will rule not over, but *in*, all heads, and with its combinations of ideas, as with magic formulas, bend the world to its will! The time may come when the victory of Waterloo prove less momentous than the opening of the first Mechanics’ Institute.”

How true Carlyle’s observations have proved to be! Waterloo is still famous in history—but of much less importance to the world’s progress, than are hundreds of modern developments made possible by men trained to *think!*

*J. E. Smith*