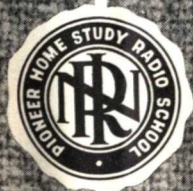


**HOW TO SELECT AND
ERECT TV ANTENNAS**

60RH-3



NATIONAL RADIO INSTITUTE

WASHINGTON, D. C.

ESTABLISHED 1914

STUDY SCHEDULE No. 60

For each study step, read the assigned pages first at your usual speed, then reread slowly one or more times. Finish with one quick reading to fix the important facts firmly in your mind. Study each other step in this same way.

1. IntroductionPages 1-3

Here you learn that advanced planning, which includes making a preliminary survey of the location, makes any installation easier.

2. Primary-Area AntennasPages 3-14

The chief problem in a primary area is the elimination of ghosts. You will study this, as well as multi-channel reception, fixed antennas, indoor antennas, and temporary antennas.

3. Fringe-Area AntennasPages 15-22

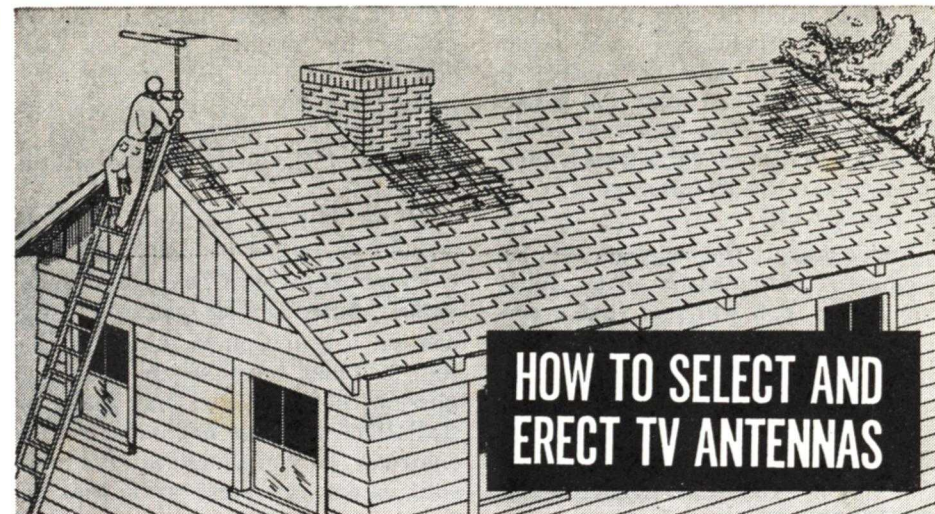
In this section, you learn what antennas are used in fringe areas and how they are gotten high enough in the air to intercept a usable signal.

4. Installing AntennasPages 22-36

This section covers the tools you will need, choosing the antenna location, mounting the antenna, antenna rotators, running transmission lines, and orienting the antenna.

5. Answer Lesson Questions, and Mail your Answers to NRI for Grading.

6. Start Studying the Next Lesson.



ANTENNA installation is one of the important activities of a television serviceman. The serviceman may not make the actual installation of an antenna, because this is a mechanical job that can be performed by someone who is not a skilled electrical technician, but he always selects the kind of antenna to be used and more or less supervises the operation of putting it up. He is also called upon to solve the problems that arise when a "standard" installation does not prove satisfactory.

As a television serviceman, therefore, you must know how to select and erect antennas that will bring in television signals of sufficient strength to operate a television set properly. You have already studied the theory of antennas in an earlier Lesson; in this one, we shall describe the practical aspects of choosing an antenna for primary area and fringe area installations and teach you the general procedure used to put the antenna up at a place where it will pick up sufficient signal.

Naturally, every installation is different in some respect from every

other. For this reason, we shall give you general information instead of attempting to describe each step of an installation in detail. We shall discuss all types of antenna installations, so this Lesson will give you a good start toward the mastery of all antenna problems.

Before we discuss specific kinds of antenna installations, let's take up a few matters that apply to any installation.

PRELIMINARY SURVEY

Advanced planning will make an antenna installation easier and more apt to be successful the first time. Unless you have had experience with the reception in the general area where the installation is to be made, a preliminary survey of the location should be a part of your advanced planning. Such a survey may be very easy: if you find that nearby houses are equipped with simple TV antennas, you can justifiably assume that such an antenna is all that will be needed for your customer's house. On

the other hand, it may be a major project in a fringe area where reception is usually poor or spotty: in such a location, you may find it necessary to make elaborate tests to determine whether enough signal is present to make the installation of a TV set worth while.

Incidentally, the matter of the neighbors' antennas is often fairly important. You will find that a customer will often demand an antenna that is at least as complicated in its appearance as are those of his neighbors, even though it is not actually necessary for the reception of signals. You may be able to overcome such an attitude by pointing out that the customer's set is so excellent that it does not require an elaborate antenna, but very often you will find it simpler just to go ahead and put in the more complex one.

We mention this fact because there is an economic factor to be considered in antenna installations. In most metropolitan areas where the cost of the installation is included in the service contract that the customer buys at the time he gets his set, about \$20 is allowed to cover a normal antenna installation, including the cost of the antenna itself. Obviously, then, it is desirable to keep the cost of the antenna as low as possible, since the cost of labor in putting up the antenna is by no means inconsiderable, and the \$20 fee must cover both of them. This limited allotment of funds for erection of the antenna is another reason why a preliminary survey that makes the work faster is a very good idea.

Of course, if the location is such that the erection of the antenna is unusually difficult, an extra charge must be made. This is usually necessary in fringe areas, where an installation and antenna erection charge of

\$100 or \$200 is not unusual. The necessity for making such an extra charge is another good reason for a preliminary survey, because the customer should always be warned in advance if the extra charge will be necessary.

If an outside antenna is to be erected on rented property, the owner's permission must be secured in advance. Most service contract forms contain a provision to the effect that the customer must secure such permission; however, you may make installations that are not under service contracts, so you should always make sure before you start work that the necessary permission is secured. It is a wise precaution to make sure that the permission is in writing.

ANTENNA TYPES

You studied the radiation patterns and other characteristics of several kinds of antennas in an earlier Lesson. As we shall point out later in this Lesson, often these antennas are much alike; therefore, although there are a great number of antenna types available, many of them are just about the same as far as their effectiveness in any particular location is concerned. The tendency of antenna installers or those in charge of antenna installations is to settle on a few favorite kinds of antennas that they use for almost every kind of installation. If you follow this system, you will become so familiar with the abilities of the particular antennas you select that you will be able to estimate very accurately which one will be satisfactory in a particular location.

One of the things you should consider when you are comparing one antenna with another is the ease with which it can be assembled. Antennas differ considerably in this respect; some are much easier to put up than

others. Naturally, the ease of assembly of an antenna affects the amount of time that must be spent to install it and consequently affects the cost of the job. It may be, therefore, that an antenna that costs a little more than others but is much easier to put together may be less expensive than the others when the labor cost is added to the cost of the antenna itself.

Of course, being easier to put together is no advantage if the antenna is not solid and strong when assembly

has been completed. Strength of the antenna should not be sacrificed, because an outdoor antenna must be able to withstand high winds, ice formations, and the effects of weather. An antenna is rather difficult to service once it has been installed, so you should make sure that it is going to require as little servicing as possible when you put it up.

Now, let's learn how to make installations in primary areas where the signal strength is high.

Primary-Area Antennas

Lack of signal strength is usually no problem in the primary area of a television station. Instead, the chief problems are usually to eliminate ghosts and, if there is more than one station in the vicinity, to pick up all of them.

Let us discuss the problem of eliminating ghosts first.

GHOSTS

As you know, one cause of ghosts

is the arrival of signals at the receiving antenna over two or more paths that are different in length. An example of such reception is shown in Fig. 1. Here, the dipole picks up a direct signal from the transmitter over path A and picks up a reflected signal over path B. If the difference between the lengths of these two paths is greater than 70 feet, a ghost will be produced in the image on the picture tube of the set.

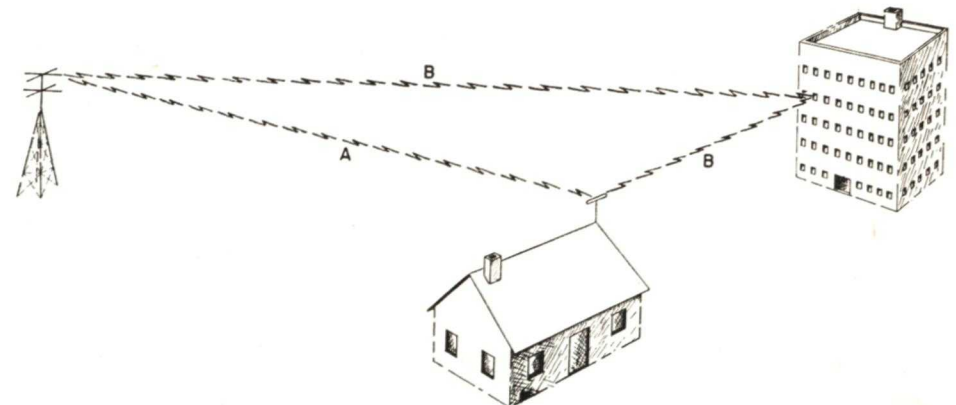


FIG. 1. Ghosts are produced when a TV signal reaches an antenna over two paths that differ considerably in length.

Ghosts may also occur if the impedance of the transmission line does not match that of the receiver and of the antenna. If both ends of the transmission are mismatched, signals will be reflected up and down the line, effectively increasing the path length of the reflected signals as compared with the path length of the direct signal (which, in this case, is the signal that is absorbed by the receiver from the line the first time the signal comes down the line). Again, a path difference of about 70 feet is enough to cause ghosts; in other words, it is possible for ghosts to be visible if the mismatched transmission line is longer than 35 feet (since then the reflected signal will travel a total of 70 feet from the receiver to the antenna and back to the receiver again).

Ghosts caused by the pickup of reflected signals are usually more troublesome inside a large city than they are in the suburbs, because, within the city, the presence of large buildings from which the signals can be reflected may cause the signal to come to the antenna from several different directions. Furthermore, the reflected signals may be quite strong within the city because of the high signal strength that is maintained for such areas. In the suburbs, on the other hand, it is rare for ghost signals to arrive from more than one direction, and they are not usually nearly as strong as the direct signal.

Let's see how ghosts caused by reflections and by improper impedance matching can be eliminated.

ELIMINATING REFLECTIONS

Ghosts caused by the pickup of reflected signals can frequently be eliminated by using a reflector. As you know, the use of a reflector sharpens the directivity of the antenna in

the forward direction and makes its pickup very small in back. If the antenna can be oriented so that the desired station is picked up from the forward direction of the antenna and the undesired reflected signals approach the antenna from the reflector side, the antenna will pick up only the direct signal, and ghosts will therefore be eliminated. If necessary, a director can be added to the forward side of the dipole to increase the directivity even more. This may not be possible if several channels are to be picked up, however, because the use of both the reflector and a director reduces the band width of the antenna very seriously.

Although the exact acceptance angles of antennas are often given in theoretical discussions, the only use made of such information in practice is to take it as a guide to whether an antenna is highly directional, broadly directional, or relatively non-directional. No serviceman plots such angles before making an installation in an area where the signal strength is high. Instead, he puts up an antenna and, if ghosts are present, orients the antenna to see if he can eliminate them. Most servicemen put up a plain or folded dipole first if it seems likely that there will be little trouble with reflections. In a congested area, however, where there are many buildings capable of causing reflections, it is highly probable that a reflector will be needed to eliminate ghosts. In such areas, therefore, most servicemen will install a dipole and a reflector from the start, particularly if such antennas are used in near-by locations.

In areas in which there are several stations, the problem of eliminating ghosts caused by reflections is complicated by the fact that orienting the antenna to a position that eliminates

ghosts on one station may cut out another station altogether. In such a case, it may be necessary to use two antennas or an antenna rotator. We

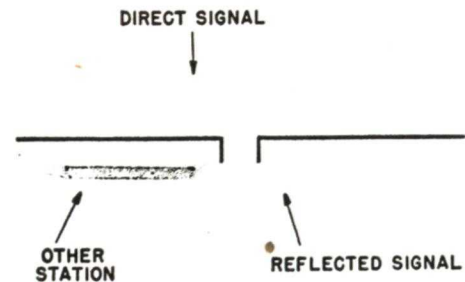


FIG. 2. Here ghosts can be eliminated by not picking up the direct signal.

shall discuss this problem a little farther on in this Lesson.

If it is not possible to orient the antenna so that you can pick up the direct signal but not the reflected one, it may be possible to turn it so that you can pick up the reflected signal and ignore the direct one. An example of a situation of this sort is shown in Fig. 2. Here, we cannot orient the antenna to eliminate the reflected signal without also eliminating the direct signal, because the antenna picks up equally well from the front and the back. Further, we cannot put a reflector on the side of the antenna from which the reflected signal comes, because doing so would also eliminate the signal from the other station. However, we can put a reflector on the side of the antenna from which the direct signal comes, eliminating the direct signal and picking up both the reflected signal and the signal from the other station. A reflected signal is, of course, weaker than a direct one, because part of the signal is absorbed each time it is reflected. In a high-strength area, however, the reflected signal will probably be

strong enough to operate the receiver well.

Ghosts can also be caused temporarily by a passing airplane that reflects a signal to the antenna. Such ghosts are often annoying, particularly when the antenna is so near an airport that planes pass by frequently, but there is very little that can be done about them.

It is also possible for ghosts to be transmitted by a station itself. If there is a mismatch between the coaxial network line and the input of the transmitter, for example, there may be reflections up and down the coaxial line that will cause a ghost signal to be applied to the input of the transmitter. There is nothing whatever that can be done at the receiver to eliminate ghosts of this sort, of course. You can usually tell whether a ghost is being transmitted by a station by watching several programs from that station. If the ghost is not present on each program, and particularly if it is present on network programs but not on local ones, the ghost signal is being transmitted by the station.

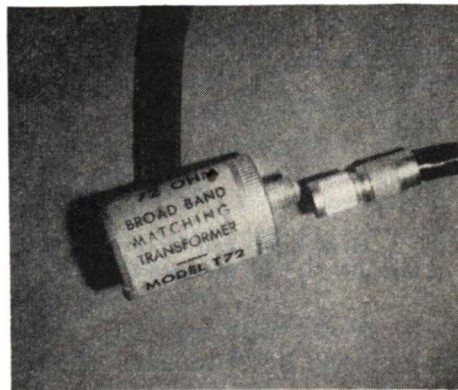
IMPEDANCE MATCHING

Ghosts caused by mismatches between the antenna, the line, and the set can be corrected by matching the line to the set. On a new installation, it is always possible to use a transmission line that will match the impedance of the set, because there are only two input impedances (72 ohms and 300 ohms) used in modern sets, and both 72-ohm and 300-ohm lines are available. Therefore, if the input impedance of the receiver is fixed at all frequencies, it is possible to eliminate such reflections completely by using the line that will match the impedance of receiver input. Some re-

ceivers, however, have tuned inputs that may vary in impedance from station to station. There is no practical way of varying the impedance of the line similarly, so ghosts caused by impedance mismatches cannot be eliminated altogether when such a receiver is used. However, using a line that matches the nominal input impedance of this receiver will usually reduce the ghosts very considerably.

If a customer who already has a television set buys a new one, the chances are that he will already have an outdoor antenna installed. If the line used with this antenna is not of the right impedance to match the new set, you will have to replace the line, or, if that is too difficult, use a transformer to match the line to this set. A matching transformer that will match 72 ohms to 300 ohms is commercially available; a schematic diagram of one is shown in Fig. 3. This

and the antenna causes only loss of signal as long as the line and the receiver are matched. As a matter of fact, the antenna and line are often deliberately mismatched to produce broad-band reception. As you learned in an earlier Lesson, this is possible



Courtesy Workshop Associates

This is the matching transformer that is shown schematically in Fig. 3.

only if the line has a higher impedance than does the antenna; then the increase in impedance of the antenna at off-resonance frequencies will make it approach the impedance of the line at those frequencies and therefore make the over-all response of the system better.

Now, let us learn more about the problems involved in securing multi-channel reception.

MULTI-CHANNEL RECEPTION

Every TV antenna now used is directive to some extent; in other words, it will receive better in some directions than in others. As we just saw, it is often highly desirable for the antenna not to receive in some directions, since this permits ghosts to be reduced or eliminated. However, it is often not desirable to have the antenna very directive when several stations must be picked up, be-

cause it may then be impossible to get all stations with a single antenna.

There are two possible approaches to the problem of getting reception from several stations. One is to use a fixed antenna or a combination of fixed antennas that will, when properly oriented, pick up all stations.

The other way is to use a highly directive broad-band antenna that can be rotated mechanically to pick up the desired stations.

An arrangement of the latter sort is shown in Fig. 4. The antenna, which was described in an earlier Lesson, consists of a high-band folded dipole, a low-band folded dipole, and a low-band reflector mounted one behind the other in a horizontal plane. The high-band dipole acts as a director for the low-band dipole, and the low-band dipole acts as a reflector for the high-band dipole. The radiation pattern of this antenna is very

the average pickup is about the same as that of a dipole. It is, therefore, very suitable for multi-channel use. Because of its single-lobed radiation pattern, however, it cannot be used unless all the stations are in the same general direction from the receiver or unless a rotator is used with it. In-

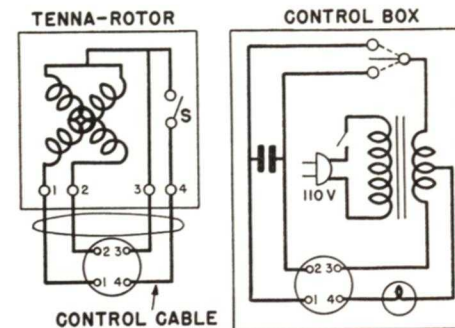
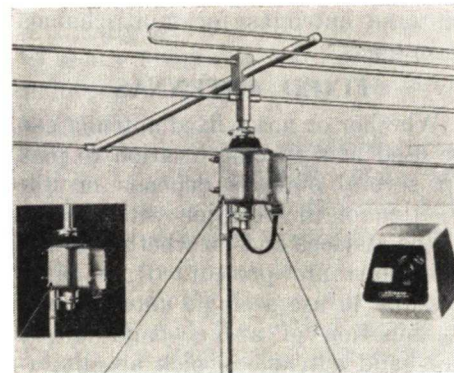


FIG. 5. Diagrams of the electrical components of the Tenna-Rotor and its control box. The 4-lead control cable runs from the motor to the control box. To trace connections, notice that each wire in the cable plugs into the control-box socket bearing the same number.



Courtesy Alliance Mfg. Co.

FIG. 4. The "Tenna-Rotor" antenna rotator.

directional for all television frequencies, having a single large lobe projecting forward at right angles to the dipoles and practically no backward pickup. Its pickup is greater than that of an ordinary dipole for all channels except channel 2, for which

identally, the transmission line of the antenna is not shown in Fig. 4; the line shown is the control cable for the antenna rotating motor.

The "Tenna-Rotor" shown in Fig. 4 is a slow-speed reversible motor that is mounted on top of the antenna mast. It has a hollow shaft into which the mounting post of the antenna can be inserted. Two clamps will hold the antenna mounting post in position. The motor is enclosed in a weather-proof housing.

The direction of rotation is controlled by turning a switch on a control box that is placed near the set. This box contains the transformer and a two-position switch; the schematic diagram of its internal connections is shown in Fig. 5. The transformer converts 110-volt a.c. to 24-

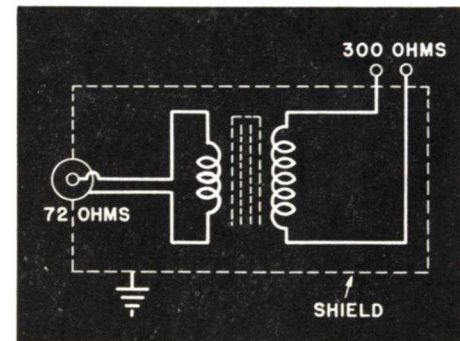


FIG. 3. Schematic diagram of a transformer that matches 72 ohms to 300 ohms.

transformer will produce matches in either direction—in other words, it can be used to match a 300-ohm line to a 72-ohm receiver or vice versa.

Generally speaking, it is not necessary to match the line to the antenna in an area where the signal strength is high. A mismatch between the line

3
volt a.c., the power supply from which the rotating motor is to run. This low voltage is used because the electrical code permits it to be carried about through an exposed cable. If 110-volt a.c. were used for the control circuits, the electrical cable from the control box to the rotator would have to be installed in rigid conduit, which is both difficult and expensive to use.

Notice the switch S in the schematic diagram of the Tenna-Rotor shown in Fig. 5. This is a limit switch that closes when the motor turns as far as it can in either direction. As you can see from the circuit, closing this switch completes a circuit from the transformer through a small lamp in the control box; the lamp then lights, thus indicating to the operator of the device that the motor will turn no farther in the direction in which it has been moving. Although the motor cannot turn continuously in one direction, it can make a total rotation of 360 degrees from one end of its travel to the other.

The 4-conductor cable, which is visible in Fig. 4, connects the rotator to the control box. This cable is plugged into a receptacle in the box. The rotator will turn at a speed of about 1 r.p.m. when the control switch is thrown to the right or left and will stop instantly when the switch is brought to its center position. This speed of rotation is great enough to make the picture quality change quickly as the antenna rotates but not so great that the point at which the picture is best will be passed before the operator can return the switch to its center position and stop rotation.

Although other kinds of antennas can be rotated by this device, the one shown in Fig. 4 is particularly

well suited for this use because it is mechanically strong and not very heavy. It would be more difficult to rotate a stacked array or another form of large antenna, although it can be done.

A disadvantage of most antenna rotators developed up to the present, aside from the fact that they are rather expensive, is that many of them break down after a few months' service. This is purely a mechanical difficulty that will probably be overcome in the future by improvements in design.

Sometimes using a rotatable antenna is the only way that good reception can be gotten from all stations. Often, however, it is possible to use a fixed antenna or a combination of fixed antennas to pick up all stations reasonably well. The use of a fixed antenna is desirable in one respect, because it eliminates the cost of a rotator. Let's learn more about the use of these antennas for multi-channel reception.

FIXED ANTENNAS

Whether or not a fixed antenna can be used in a specific location to pick up several stations depends on the position of the location with respect to the stations and on whether or not reflections are present. It is often possible to use a single antenna or a combination of a high-band and a low-band antenna to pick up all stations. Sometimes, however, it is necessary to use several antennas.

In many locations, a dipole (plain or folded) or a dipole and a reflector will give good reception over several channels. The radiation patterns for a dipole in both the high and the low bands are shown in Fig. 6. The solid lines show the radiation pattern of the antenna for high-band frequencies, the dotted lines show it for low-

band frequencies. The addition of a reflector would reduce the backward pickup of low-band frequencies considerably, but it would not affect the pickup of high-band frequencies in this direction very much. It would also increase the forward pickup at low-band frequencies.

As you can see from this radiation pattern, this antenna will pick up from most directions reasonably well. It will not pick up off its ends, however, unless the station is very close by; therefore, if two low-band stations that are at right angles to one another with respect to the antenna location are to be picked up, usually a single dipole cannot be used. It can be used to pick up two high-band stations that are at right angles to its location, however, since there is approximately a right angle between two of the major lobes in the high-frequency pattern.

If all stations are on the same side of the dipole, a reflector can be added to secure greater forward pickup and reduce pickup from the backward direction.

4
What we have said previously about dipoles applies to both plain and folded dipoles, since the two have identical radiation patterns. They differ in their impedances, however; the plain dipole has an impedance of 72 ohms, and the folded dipole an impedance of 300 ohms. Therefore, if the receiver has a 72-ohm input, it is logical to use a plain dipole and a coaxial line, thus getting an impedance match throughout the antenna system. If the receiver has a 300-ohm input, a folded dipole and a 300-ohm line would give a match throughout. Some prefer to use a plain dipole and a 300-ohm line with 300-ohm receiver, because this gives broad-band reception.

High-band stations are somewhat difficult to pick up with an antenna that is cut for the low band, particularly those stations that are at the upper end of the high band. Therefore, when both low-band and high-band stations are to be received, it is often necessary to add an antenna cut for the high band to one that is cut for low-band use, isolating the two by connecting them with a quarter-wave length of transmission line. The two antennas can then be oriented separately to pick up the stations for which they are cut; and neither will have much effect on the other.

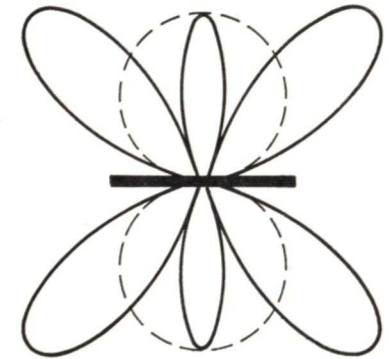


FIG. 6. Radiation patterns in the low band (dashed lines) and the high band (solid lines) for a dipole cut to be $\lambda/2$ long in the low band.

The dipole or folded dipole is the basic antenna that is used in most primary area installations, but there are other kinds having more complex radiation patterns that sometimes prove to be better for multi-channel use. One of these is the bat-wing antenna shown in Fig. 7. The radiation pattern of this antenna is shown in Fig. 8. As you can see, this antenna has multiple lobes at the high frequencies and the familiar figure-8 pattern of the dipole at low frequencies. In some locations, this pattern may prove to be ideal for picking up the various stations in the area.

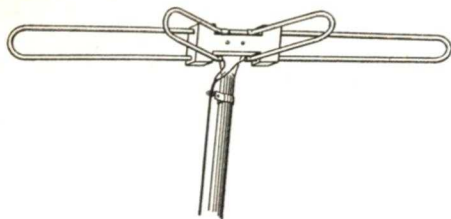


FIG. 7. The bat-wing antenna.

Another antenna having a multi-lobe pattern is the duo-dipole antenna shown in Fig. 9. This antenna consists of a thin dipole cut to be $\lambda/2$ at 70 mc. that is mounted by inductive loops close to a thick dipole that is cut to be $\lambda/2$ at 180 mc. The inductive loops provide both electrical connections and mechanical support for the low-band dipole.

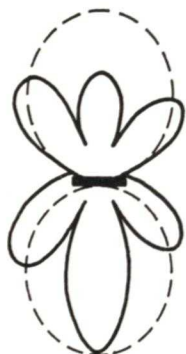


FIG. 8. Radiation patterns for the bat-wing antenna in the low band (dashed lines) and in the high band (solid lines).

The radiation pattern of this antenna is shown in Fig. 10. As you can see, it has multiple lobes much like those of the bat-wing antenna for the high band and roughly a figure-8 pattern for the low band. Because of the similarity in their radiation patterns, there is not much to choose between the bat-wing and the duo-dipole antenna; either may be well suited to a specific location.

These are by no means the only kinds of television antennas that can be used in areas of high signal strength. As a matter of fact, new kinds of antennas are constantly being introduced. Whether other kinds will be more useful to you than those

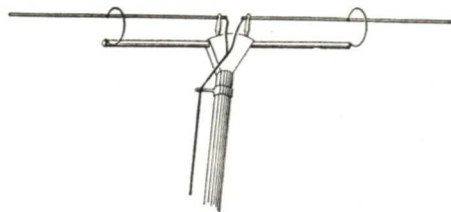


FIG. 9. The duo-dipole antenna. The thick dipole is the antenna for the high band, the thin one that for the low band.

we have already described depends principally on the location: if an antenna has a peculiar radiation pattern, it may solve an installation problem that no other antenna will take care of. Usually, however, you can use a dipole or a combination of dipoles, with or without reflectors, to get a good signal in almost any location in a high-strength area.

As a matter of fact, it is often not necessary to have a roof-mounted antenna in a location where the signal strength is high. It may be possible

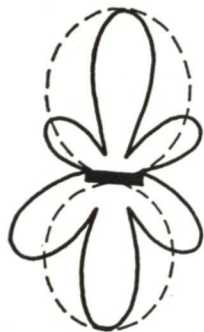


FIG. 10. Radiation patterns for the duo-dipole antenna in the low band (dashed lines) and in the high band (solid lines).

to use an indoor or a window antenna to operate a set satisfactorily. This is fortunate, since many apartment house owners will not permit erection of a roof-top antenna.

We are going to describe the installation of antennas in the last section of this Lesson. However, since the installation of an indoor or window antenna is a fairly simple job, we shall discuss such installations here and reserve the section on installation for the more difficult problem of installing an outdoor antenna.

INSTALLATION OF INDOOR ANTENNAS

There are many types of indoor antennas on the market, all of them of about equal ability to pick up a signal.

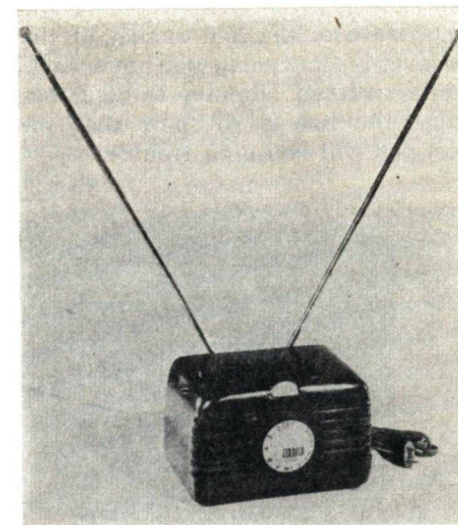
One popular form is shown in Fig. 11. The poles of this antenna telescope and can be extended or closed up readily. As the figure shows, the angle between them can be changed as much as desired. The whole antenna can be picked up and rotated.

Installation of this antenna is very simple. It comes equipped with an 8-foot length of 300-ohm line; to install it, just connect the line to the antenna terminals on the receiver.



Courtesy Insuline Corp. of America

FIG. 11. A common form of indoor antenna that can be adjusted in length, angle, and position.



Courtesy Jerrold Electronics Corp.

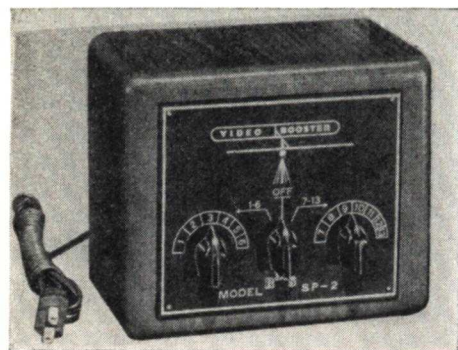
FIG. 12. An indoor antenna that is combined with a booster.

Another form of antenna is shown in Fig. 12. This is like the one in Fig. 11 except that the antenna is connected directly to a booster, to the output terminals of which the set is connected. We shall discuss boosters in another Lesson at some length; for now, let's just say that a booster is a one- or two-stage r.f. amplifier connected between the antenna and the input of the set. A booster is usually tunable; the one shown here can be tuned to each of the low-band channels, to the FM band, and to channel 7. A single setting tunes it to channels 8 and 9 and another setting tunes it to channels 10, 11, 12, and 13.

Sometimes, because of its gain, an antenna-booster combination of this sort will permit the use of an indoor antenna in locations where a plain indoor antenna will not furnish an acceptable signal.

An indoor antenna should be placed close to the receiver; very often, it is

placed on top of it. Matching the impedance of the line to that of the receiver is of no particular importance when such an antenna is used, because the line is so short that reflections will cause no trouble.



Courtesy Radio Merchandise Sales

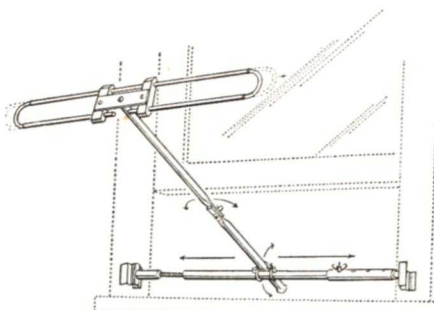
A typical booster. This device may be used with any kind of antenna.

In most locations, it is necessary to adjust an indoor antenna for each station. The lengths of the arms or the angle between them may have to be adjusted, or the antenna as a whole may have to be rotated to get the best signal. This calls for the performing of a certain amount of work by the person operating the set, but, since most programs last for half an hour or an hour, most people are willing to spend a moment in making the adjustments to get a satisfactory signal.

Indoor antennas of this sort will work reasonably well on the upper floors of an apartment building. However, they will often fail to give satisfactory performance on the ground floor or even on the second floor; and in basement installations, they are usually worthless. If it is impossible to obtain good reception with an indoor antenna, the more efficient window antenna may give a satisfactory signal.

A typical window antenna is shown in Fig. 13. Usually an apartment owner who will not permit the use of an outdoor antenna will allow one of this sort to be used, because often his refusal to allow an outside antenna to be erected is caused by the fact that he does not want holes drilled in the side of the building or the window casement to mount the antenna and bring the transmission line into the room. It is not usually necessary to drill any holes to erect a window antenna, and it is usually possible to use a flat ribbon of twin lead line and work it through the window opening without cutting any holes.

To install an antenna of this sort, extend the adjustable cross arm until it is firmly secured between the two sides of the window opening. The short antenna mast can then be placed at any desired angle with respect to the wall of the building. There is no particular advantage to keeping the antenna away from the wall unless the antenna has to be rotated; if rotation is not necessary, bring the antenna up close to the wall to make it as inconspicuous as possible.



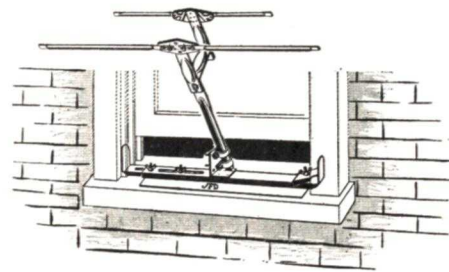
Courtesy Insuline Corp. of America

FIG. 13. An adjustable window antenna.

Such an antenna may not be usable if the windows are of the casement type, which open outward. Even

if the windows are of this kind, however, you may find it possible to mount the cross arm below or above the windows in the window opening, in which case you may be able to make the installation satisfactorily.

If the window is the sort that can be raised or lowered, you can usually slip unshielded twin-lead line through the space between the top and bottom sashes. To do this, open one sash, slide the transmission line through



Courtesy J. F. D. Mfg. Co., Inc.

Another kind of adjustable window antenna.

the space between the two, and close the sash again. If the two sashes happen to make a tight fit, there may not be room to do this without cutting or injuring the transmission line in the process. If so, you may be able to bring the line through above the top sash, under the lower one, or at some place where the two sashes do not fit tightly.

Both the length and the orientation of this antenna can be adjusted; and usually both must be to get good reception. Finding the right adjustment of these two is a matter for experiment. It is usually best to start with the antenna extended to about its maximum length. Then rotate it to see if some position can be found that will give acceptable reception on all stations (of course, the antenna must be connected to the set and the set must be in operation when this is

done). If it proves impossible to get a good picture from all stations, try shortening the antenna and then changing the position. It may be necessary to repeat this process several times to find the best setting and length.

If you find that one position and length are best for one or two stations, but that another position and another length are needed to bring in some other station or stations, and you cannot find a compromise position that will permit all the stations to be received, it may be practical to install two window antennas, adjusting one for one group of stations and the other for the other group. You may find it possible to connect both antennas to the receiver in parallel. If doing so produces a poor picture, use a low-capacity switch to connect the particular antenna you want to the receiver. The schematic diagram of the switching arrangement of this sort is shown in Fig. 14. An ordinary 2-position knife-blade switch can be used.

Although it is usually best to mount a window antenna in a window that faces the transmitter or transmitters, it is often possible to get just as good a signal on the other side of the house

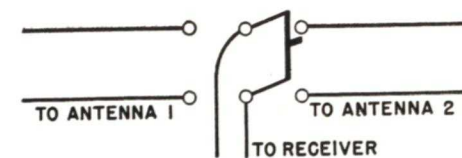


FIG. 14. Arrangement that permits a receiver to be switched from one antenna to another.

if there are near-by objects or buildings that can reflect the signal to this side. Very often it is possible to get reasonably good reception even in unlikely locations with a window antenna. Of course, there are some

locations in which a window antenna will not prove satisfactory.

TEMPORARY ANTENNAS

Very often it is impossible to put up the permanent antenna at the same time that a set is delivered to the customer. In such a case, it is almost always necessary to furnish some kind of an antenna so that the customer can get reception temporarily until his permanent antenna can be installed.

Probably the best way to provide a temporary installation is to lend the customer an indoor antenna. One of the kind shown in Fig. 11 is convenient to carry and easy to install.

A temporary antenna can also be made from a piece of 300-ohm transmission line. Use a length approximately 64 inches long, strip the ends

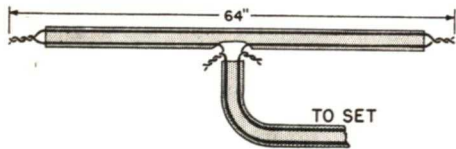


FIG. 15. A temporary antenna that can be made easily. Use 300-ohm unshielded twin-lead line.

of the lines, and solder the leads together. Next, break one of the leads in the center of the strip and connect the two ends thus formed to the ends of another piece of 300-ohm line (see Fig. 15). Connect the other end of this line to the receiver.

A home-made antenna of this kind will usually give satisfactory reception on at least some of the local stations. You can lay it on the floor, perhaps under a rug, or hang it on the wall, say along the top of a window ledge where it may be hung on a curtain rod.

An antenna of this sort will probably pick up considerable noise and may produce rather severe ghosts on some stations. It is not worth while to go to much trouble to attempt to correct these conditions, since a permanent antenna installation will be made very soon, and the customer will probably be content to get at least some reception in the meantime.

TRANSMISSION LINES

Under most conditions, shielded line is preferable for city installations. The reason is that there is apt to be a great deal of man-made noise in almost any city location: if the house where the antenna is to be installed is near the street, for example, the ignition noise of passing cars may cause a considerable amount of interference in the picture. The use of shielded line will pretty much eliminate this source of interference and most others caused by line pickup. In addition, shielded line is much more resistant to the effects of weather than is unshielded line.

Both coaxial line and shielded twin-lead line have higher attenuations than does ordinary twin lead. This is a matter of little concern in most primary-area installations, however, since the signal strength in such an area is high enough so that line losses are unimportant.

However, most servicemen use unshielded twin-lead line whenever possible, because it is less expensive than coaxial line and very much less expensive than shielded 300-ohm line. As we pointed out earlier, costs are often extremely important in an installation.

Fringe-Area Antennas

When you make an installation in a fringe area, your chief problem will probably be to get enough signal to operate the set. For this reason, you must use a high-gain antenna. You will almost invariably find it necessary to mount this antenna high in the air; an indoor or window antenna is seldom, if ever, usable in a fringe area. Because high-gain antennas usually have very narrow band widths, it is not uncommon to have to use a separate antenna for each station that is to be picked up.

One of the main difficulties with fringe-area installations is that reception is apt to be very spotty in locations that are at a considerable distance from the transmitter. It may be possible to get relatively good reception at one point and impossible to get anything at another point only a few hundred yards away. Even though there are television sets already installed and working somewhere near the place where you are considering making an installation, you cannot be sure on that account that a satisfactory installation can be made where you want to make it. For this reason, it is always a good idea to use a test antenna to learn what the reception possibilities are at the place you want to make the installation before you go ahead with the installation.

It is no easy matter to determine the signal strength at a particular location, particularly because, if a test antenna is used, you must get it as high in the air as the permanent antenna will be before you can tell what the reception will be like. Several methods have been suggested for putting up a test antenna without installing a permanent mast first. In

at least one town, public interest in television was so great that it proved possible to persuade the local fire department to use a ladder truck to put the test antenna high in the air, thus making it possible to plot the signal strength at various locations in the town. Helium-filled balloons have also been used to get a test antenna up; in fact, the Dewey and Almy Chemical Company of Cambridge, Mass., offers such a balloon for permanent antenna installations in fringe areas.

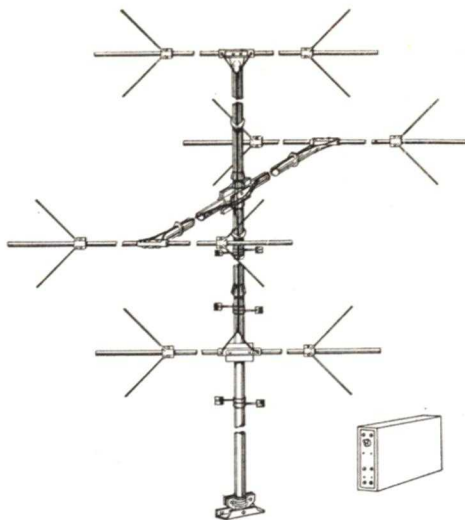
A less spectacular way to find out something about signal strength in a particular location is to raise a test antenna on a light mast. A simple way of doing this is to lay the mast on the ground and fasten the antenna to its top, then to raise the mast by hand and have several men hold it up while you are making your test. The bottom end of the mast can be slipped into a small hole in the ground to help steady it for this period of time.

The local topography often determines whether or not reception can be secured in a particular location. A near-by hill may cut off signals from locations near its base and may not interfere with reception at points farther away from it. A location in a valley may get little or no signal even if it is fairly close to the transmitter. On the other hand, it may be possible to receive well in a location on top of a hill over extremely long distances.

At locations extremely distant from transmitters, it is sometimes possible to get intermittent reception. Stations in Washington, D. C., have been picked up in Texas, for example. Such reception is apparently caused by what are known as "tropospheric ducts," which are sometimes formed

when weather conditions create a mass of warm air above the earth that is at a higher temperature than the air below it. Such ducts have the ability to refract or bend television signals so that they can be received over distances considerably greater than the line of sight. The existence of these ducts is only temporary, however, so you should not be fooled by one of them into believing that reliable reception is possible in a place where it is actually not.

Naturally, a test antenna is of no use unless it is connected to a meter or to a television set so that it can show you what results are being secured. Generally speaking, it is better to use a TV set—usually a portable one for convenience—because doing so will let you see how good a picture is being received. A meter may show a relatively high signal level when actually it is picking up considerably more noise than signal. Of course, the



Courtesy Technical Appliance Corp.

The direction from which this antenna picks up can be reversed simply by throwing a switch (shown in its housing at the lower right) that can be mounted beside the set. This feature and the high gain of the antenna make it particularly suitable for use in areas located between two transmitters or groups of transmitters—between New York and Philadelphia, for example.

very best test would be to use a receiver exactly like the one that is to be installed; this is often not practical, however, particularly since the customer's purchase of any receiver will usually be contingent upon your being able to guarantee him good reception. You can usually be sure that a large set will give good reception if a portable will.

About the only general rule that applies to the proper location for an antenna in the fringe area is to get it as high as possible. Doing so will give whatever antenna you use a better chance to intercept a usable signal. In most fringe-area installations, you will have to use some kind of tower or very high mast to support the antenna. Let's discuss these for a moment.



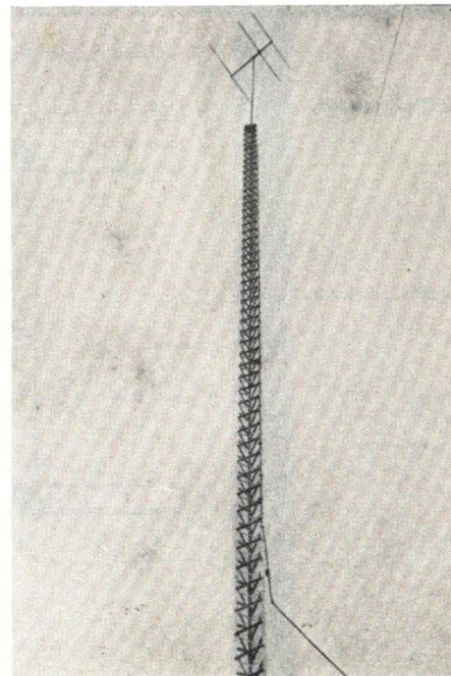
Courtesy J. F. D. Mfg. Co., Inc.

An all-band antenna that can be used successfully in areas where the signal is fairly weak.

TOWERS AND MASTS

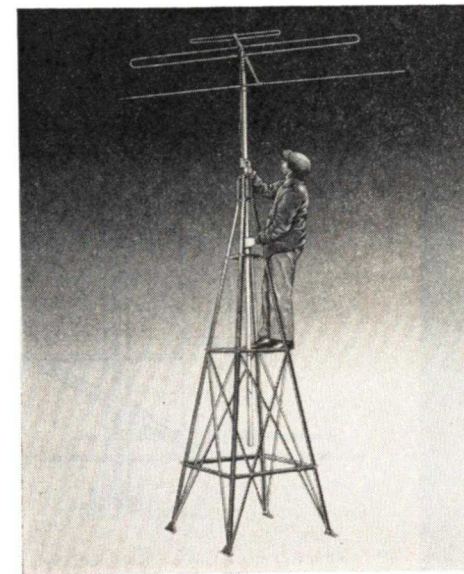
Several kinds of towers that will permit an antenna to be raised high above the ground are now commercially available. The one shown in Fig. 16 is supplied in six-foot sections; as many as 20 of these can be bolted together, making a tower 120 feet tall. A tower this tall must be held up by guy wires. For heights up to 24 feet, however, the tower is self supporting. This particular tower is supplied with a mounting plate that can be used to mount it on the ground or on the roof of a house and with a stand-off support than can be used to secure it to the side of the house.

Another kind of tower is shown in Fig. 17. This tower is only ten feet tall; a pipe extension can be used with



Courtesy Alprodc, Inc.

FIG. 16. A light-weight aluminum tower that can be made as much as 120 feet high.



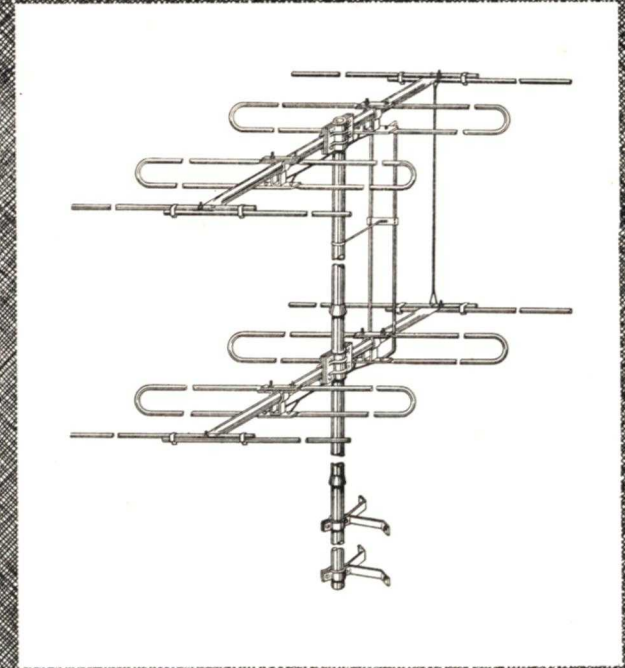
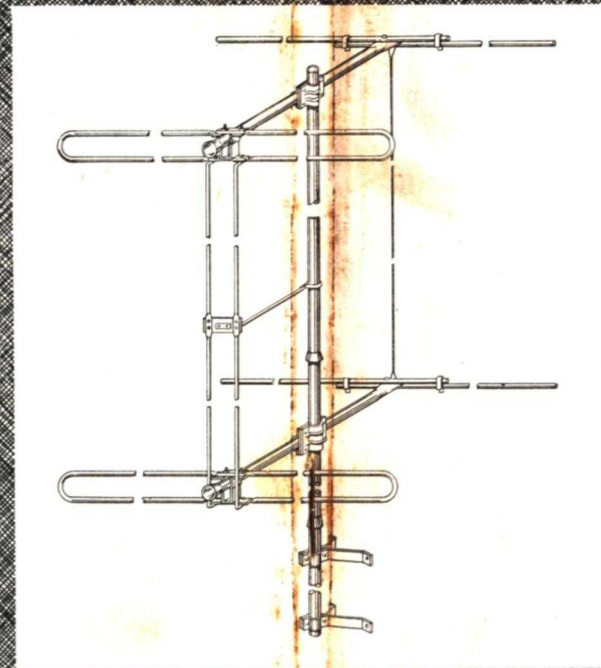
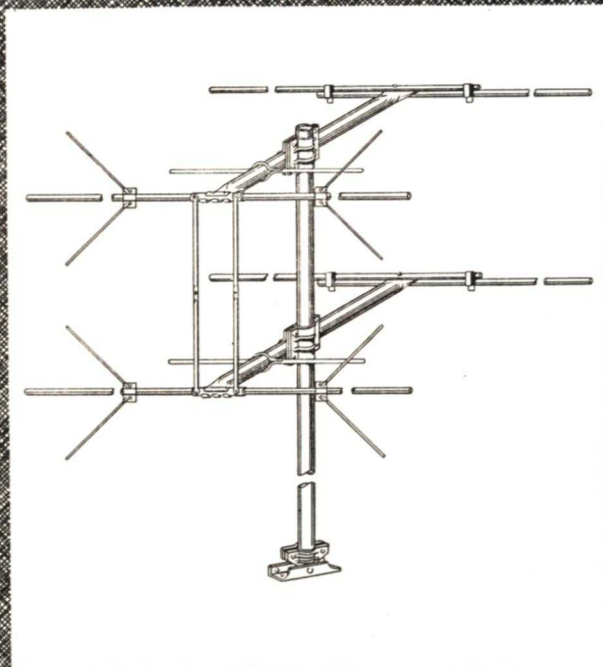
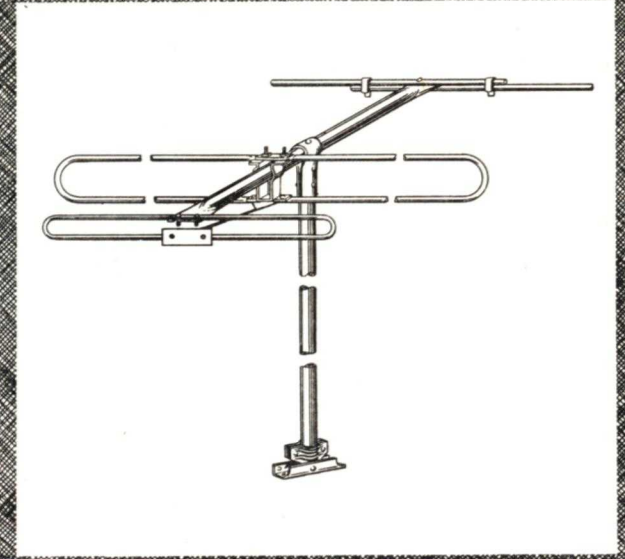
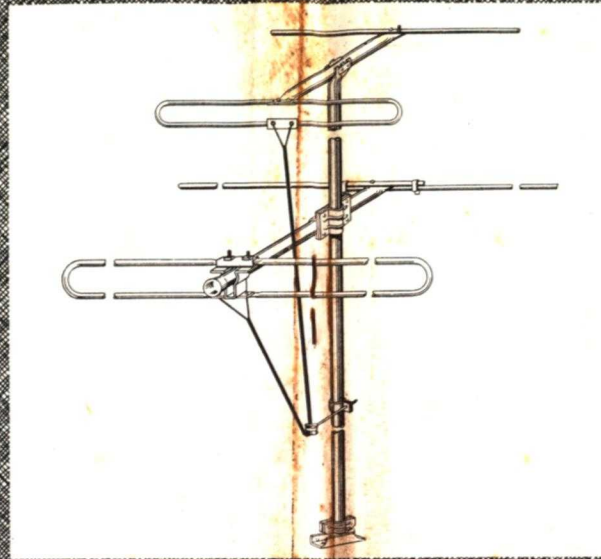
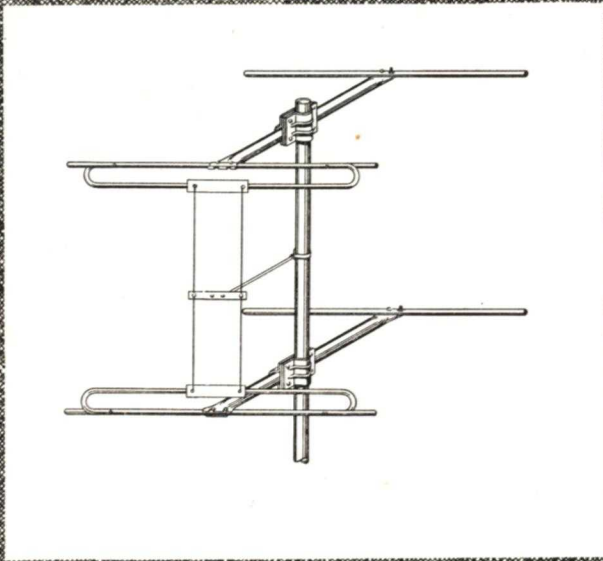
Courtesy Wincharger Corp.

FIG. 17. A self-supporting tower that can be made 20 feet high by using a pipe extension.

it to raise the antenna twenty feet above the base of the tower. Since the tower is intended to be mounted on the peak of a roof, it can give the antenna a total height above ground of thirty or forty feet.

If you prefer not to use commercial products of this sort, you may be able to build an adequate tower out of metal or wood. We cannot undertake to give instructions for doing so, but articles on the subject appear in the technical magazines from time to time.

Although it is not likely that you will erect a tower that is tall enough to need a warning light on the top for the protection of passing airplanes, it would be a good idea for you to check the CAA regulations for the location at which you are going to erect the tower. If it is near an air field, a warning light may be necessary.



Courtesy Technical Appliance Corp.

These pictures show only a few of the antennas offered by one manufacturer. As you can see, there are a great many kinds of antennas from which you can choose; but you will probably settle on just a few types that will take care of all your installations.

A mast capable of supporting an antenna 30 or 40 feet from the ground can be made of sections of 2" pipe fitted together. Such a mast cannot usually be made self supporting—that is, it must be kept in position by guy wires. We shall describe the erection of such a mast later in this Lesson.

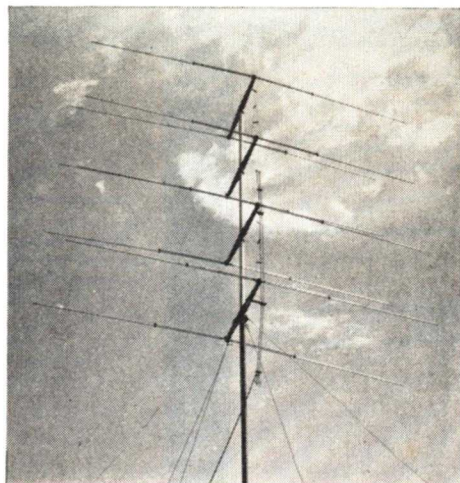
ANTENNAS

As a general rule, the complexity of the antenna you need for a fringe-area installation depends upon the signal strength in that area. If the signal strength is very low, a complicated array may be necessary; such an array is usually of a very narrow band width (in fact, many are generally usable for only one station), so you may have to use several such antennas if there are several stations



Courtesy J. F. D. Mfg. Co., Inc.

FIG. 18. A fringe-area antenna that can be used to receive stations in both bands at fairly long distances.



Courtesy La Pointe-Plascomold Co.

FIG. 19. A multi-bay antenna that has been used to secure reception from extreme distances.

within range. If the signal strength is not extremely low, you may be able to use a single antenna to get all stations. You should, of course, use the simplest antenna that will give you acceptable reception, particularly since complicated antennas are rather expensive. A stacked array of the sort shown in Fig. 18 will often provide reception in a fringe area. Notice that this antenna has both a stacked low-band and a stacked high-band array; it can, therefore, be used to pick up more than one station. If greater gain is necessary, a multi-element array like that shown in Fig. 19 may be used.

Since there are so many kinds of antennas now on the market, with new ones appearing almost every day, we shall not attempt to tell you which specific one is best for certain conditions. Instead, you should keep in touch with the latest developments by reading the technical magazines in which new antennas are usually described. When you are considering

the selection of an antenna for fringe area installation, make sure you choose one that has enough gain and, if possible, has a radiation pattern with major lobes that can be oriented toward the desired stations. You should not use a more complex array than is needed, both because the installation will be unnecessarily expensive and because the band width of the antenna usually becomes less as its complexity increases, with the result that the use of an over-complex array may prevent you from picking up a station that you could get with one that was less complicated.

The impedance match between the antenna and the transmission line is very important in the fringe area, as you know. Often the loss of signal caused by a mismatch between the antenna and the line cannot be tolerated. Unfortunately, however, the use of stacked arrays reduces the impedance of the antenna very considerably: the various elements in the stack are connected in parallel, so the net impedance of a two-bay antenna, for example, is half that of the individual antennas. Thus, an array consisting of two stacked folded dipoles has a net impedance of only 150 ohms. There will therefore be a two-to-one mismatch between this array and a 300-ohm line, which will cause a fairly considerable loss of signal strength.

If the signal level at that location is so low that such a loss cannot be tolerated, it will be necessary to use some method of matching the antenna to the line.

One way out of this is to use a 150-ohm line and create a match at the set between the line and the set; the advantage of doing this is that it is not necessary to use a matching

device at the antenna, where the connections to the device would be subject to the effects of the weather. There is no shielded 150-ohm line available, however; therefore, if it is necessary to use a shielded line because of interference problems at the location, you will have to use a 300-ohm shielded line with a matching section or matching stub at the antenna.

Of course, the match between the antenna and the line is often not critical, even in fringe areas. If the antenna has enough gain, you can afford to waste some signal. If several stations are to be picked up by the same antenna, and the impedance of the antenna does not match that of the line, you will have to forget all about an impedance match; the only practical methods of matching the antenna to the line involve the use of a matching section or a matching stub, neither of which can be used for more than one channel.

The best available antenna for extremely long-range reception is the rhombic. We discussed this antenna in an earlier Lesson, where we pointed out that it is not usable in many locations because of the large amount of space required for it. If there is enough room, however, and the antenna can be gotten high enough, a rhombic will provide reception in a location where no other antenna will.

If several stations that lie in different directions with respect to the receiving location are to be picked up, an antenna rotator will be very helpful. The antenna shown earlier with a rotator in Fig. 4 has fairly high gain, so it may be usable in a fringe area. The rotator shown in this figure is intended to support a maximum weight of only about 20 pounds; therefore, if a heavier or more elabo-

rate antenna is to be used, it will be necessary to use an auxiliary thrust bearing to support the weight of the antenna. Such thrust bearings are available from the manufacturer of the rotator.

There are also heavy-duty antenna rotators available that are designed for use with amateur receiving and transmitting equipment. These are rather expensive, but they are husky enough to move almost any antenna and are relatively trouble-free.

If there is very much electrical noise in a location in the fringe area, it will be almost impossible to get worth-while television reception there unless the antenna used has high noise rejection. The ability to reject noise is one feature of the stacked array that makes it particularly suitable for use in fringe areas. If a great deal of noise is present, the signal-to-noise ratio will be low, with the result that too much noise will be fed

to the set, thus producing snow and lines in the picture.

An annoying interference effect is sometimes produced in a fringe area that is about an equal distance from two stations on the same channel. Unless a uni-directional antenna is used, both stations may be picked up simultaneously. Even if they are transmitting the same program, there will usually be enough frequency difference between the two carriers to produce interference. This interference has been described as a "venetian blind effect," because it produces a series of bars across the face of the picture that resemble a venetian blind.

Methods are being developed for synchronizing such transmitters so this interference will not be produced. There is nothing that can be done at the receiver to prevent it, unless a directional antenna is used that will cut out one or the other of the stations.

Installing Antennas

When it comes to installing television antennas, mechanical ability is more important than electrical knowledge. In fact, usually the most difficult part of any antenna installation is the mechanical job of erecting the antenna mast, and bringing the transmission line down into the house. For this reason, dealers and service organizations very frequently have installation crews made up of skilled mechanics who do not or need not have much technical knowledge of television. These men need to know only enough about electrical work to make the proper connections to an antenna and bring the transmission line down to the receiver.

Even though you, as a serviceman, may not make a regular practice of installing antennas, you will probably be called on to do so occasionally or to supervise the work of an installation crew. At any rate, you should know how to put an antenna up. We shall show you how in the following section of this Lesson.

The mechanical problem of mounting an antenna outdoors makes it necessary to use tools that are not usually in a serviceman's kit. Let's see first what these tools are.

TOOLS NEEDED

Since the antenna mast is often secured to the side of a brick building,

you will need equipment that will permit you to drill holes in brick or masonry. This should include a slow-speed electric drill that will handle a 1/2" masonry drill, a Rawl tool, some Rawl plugs, a supply of 1/4"-20 machine-screw anchors, a tool for expanding the anchors, a 1/2" star drill, and a ball peen hammer. The electric drill should have at least a 100-foot power cord, or a 100-foot extension cord should be used with it.

You will also need various hand tools, such as pliers, wrenches, screwdrivers, and a hack-saw. Further, you will need a brace and bit for drilling through wood and a high-speed electric drill that will handle a 1/4" drill for drilling through metal. Final-

as any special material needed to secure the antenna.

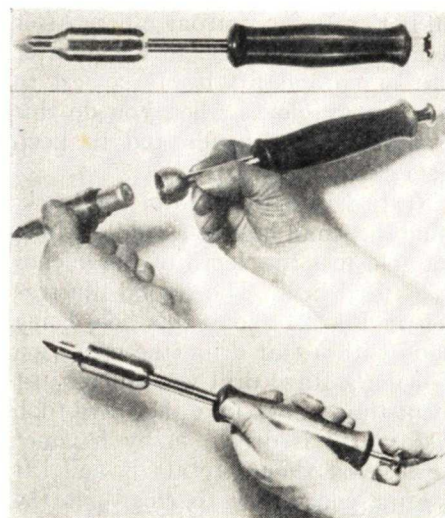
Although you do not need to use a soldering iron very often, you will find an occasional use for one when you are making an outdoor installation. A new kind of soldering iron shown in Fig. 20 has been developed for outdoor use. This iron contains a cartridge that can be "fired" by pulling out and releasing a rod that projects through the handle. When this rod strikes the end of the cartridge, chemicals contained within the cartridge are ignited. These chemicals will burn for several minutes, bringing the tip of the iron to soldering temperature in a few seconds and keeping it there for six to eight minutes, furnishing as much heat in this time as a 250-watt iron will. The cartridge is replaceable. An iron of this sort can be a great convenience, particularly when you are working outdoors and no source of electric power is available.

DRILLING MASONRY

Very often in making an installation it is necessary to secure the antenna mast to the side of a brick building. This is done by fastening some form of clamp to the bricks with screws. Since you may be unfamiliar with the technique used to secure screws to masonry, we shall take a moment to explain it.

A screw cannot easily be driven directly into a brick. Instead, the usual practice is to drill a hole in the brick, insert an expandable metal or fiber plug in the hole, and force the plug outward until it is securely fastened in the hole. Screws are then driven into this plug (which is often already threaded to accept a machine screw).

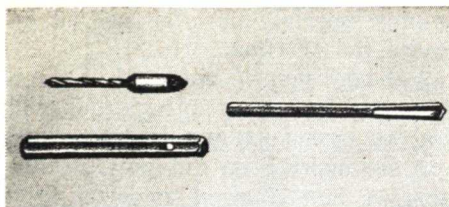
Holes can be drilled in brick either with an electric drill or by hand.



Courtesy Kemode Mfg. Co.

FIG. 20. An outdoor soldering iron that is heated by firing a cartridge contained in the head of the iron. **Top,** the complete iron; **center,** inserting cartridge; **bottom,** firing cartridge.

ly, you will need a supply of clamps, stand-off insulators, heavily galvanized guy wire, porcelain insulators for use with the guy wire, and galvanized or brass 1/4" mounting bolts, as well

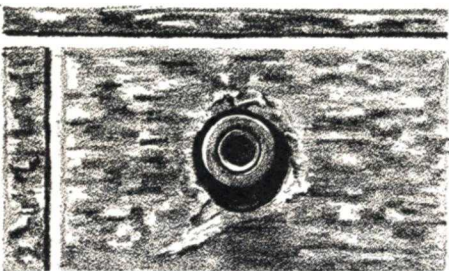


Hand drilling, which is done by hammering in a tool known as a star drill, is slower and more laborious than using an electric drill, but it is capable of giving a good job; if electric power is not available, it is usually the only way that the hole can be made.

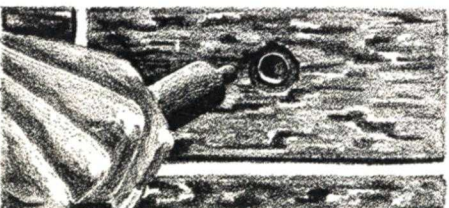


Fig. 21 shows the various steps involved in the process of securing a screw to brick. First, you should drill a pilot hole with a Rawl drill. The Rawl drill is a sharp-pointed tool that is hammered into the brick; one of the smaller sizes can be driven in rather easily. A typical Rawl drill and drill holder are shown at the left in the top illustration in Fig. 21. Beside them is shown a star drill.

To make a hole with a Rawl drill, hammer it into the brick, using firm but not excessively strong blows. After each blow, rotate the tool a quarter turn or so and lift it. It is best to wear heavy gloves when you do this to protect your hands and to keep them clean.



Next, drill a $\frac{1}{2}$ " hole in the brick, using the small hole as a guide. Make the hole just the depth of the anchor to be used in it. The second illustration in Fig. 21 shows this hole being made with a star drill (the operation of using a Rawl drill would look just about the same). Like the Rawl tool, a star drill is driven in by hammer blows; you should rotate it and lift it after each blow to clear out the chipped masonry and to make a smoother hole.



If electric power is available, an electric drill equipped with a $\frac{1}{2}$ " bit

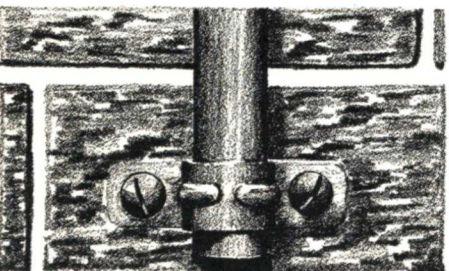


FIG. 21. How to drive a screw into brick. Use a Rawl drill and holder (top left) to drill a pilot hole, then a star drill (top right) to drill a hole for a screw anchor. Imbed the anchor in the hole with an expansion tool. The screw can then be turned into the threaded insert in the anchor.

will let you drill the hole faster than you can with a star drill. Be sure not to drive an electric drill so hard that the bit becomes overheated, because the bit may be ruined if you do.

When the hole is finished, insert a lead screw anchor in it. The next illustration in Fig. 21 shows the appearance of one of these anchors when it is first inserted in the hole.

Next, use an expansion tool to seat the anchor firmly against the sides of the hole. This tool has a small projection on one end that fits into the center hole of the anchor. Hammering the other end of the tool forces the plug to expand tightly against the sides of the hole. The next illustration in Fig. 21 shows what the fitting looks like after it has been imbedded in the hole.

In most forms of these screw anchors, there is a brass insert in the middle of the anchor that is threaded to accept a $\frac{1}{4}$ -20 machine screw. Therefore, such a screw can be used to secure a clamp or whatever form of mounting is to be used to the anchor, as shown in the bottom illustration in Fig. 21. If the anchor has been properly installed, the screw will be so secure that it will remain in place when it is subjected to an outward pull almost as great as its tensile strength.

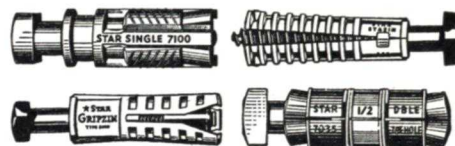
Other kinds of anchors are also used. Most of these are metal devices that will expand when machine screws, lag screws, or special nails are driven into them. Rawl plugs are often used to hold small screws in masonry, such as the small supports used to secure transmission lines to the side of the house. These Rawl plugs are made of twisted jute fibers. When one is installed in a hole and a screw is run into it, the jute fibers are compressed against the sides of the hole and hold

the screw securely. These plugs come in various sizes, for each of which there is a Rawl drill and a matching screw. When you are using one of these plugs, drill a hole whose total depth is a little longer than that of the screw that is to be run into it, minus the thickness of the material that is to be fastened.

When you are drilling a hole in a brick wall, be sure not to drill into the mortar between the bricks. A screw anchor will not hold permanently in mortar.

CHOOSING THE ANTENNA LOCATION

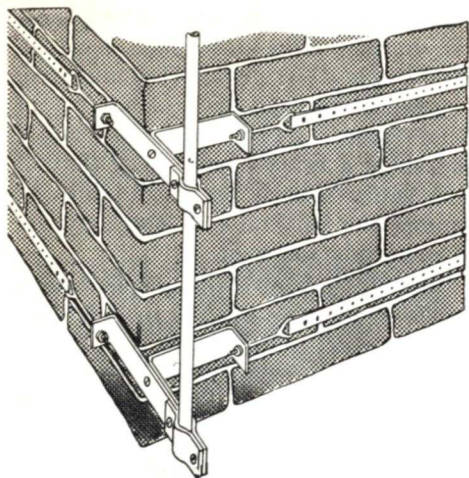
The best place to mount the antenna mast depends very largely on



Courtesy Star Expansion Bolt Co.

Four kinds of anchors that can be used to secure screws or lag bolts to brick or concrete. Each is inserted in a hole in the masonry, then expanded (either by using a special tool or by driving in the screw or bolt) until it is seated firmly against the sides of the hole.

the construction of the house. One of the commonest ways of mounting an antenna mast is to secure it to the chimney with chimney straps like those shown in Fig. 22. However, many insurance policies will not pay for damage caused by the wind to a chimney if the chimney is used to support anything (including an antenna). Always check the customer's insurance policy or warn him of this possibility before deciding on the chimney as a place to mount the antenna.

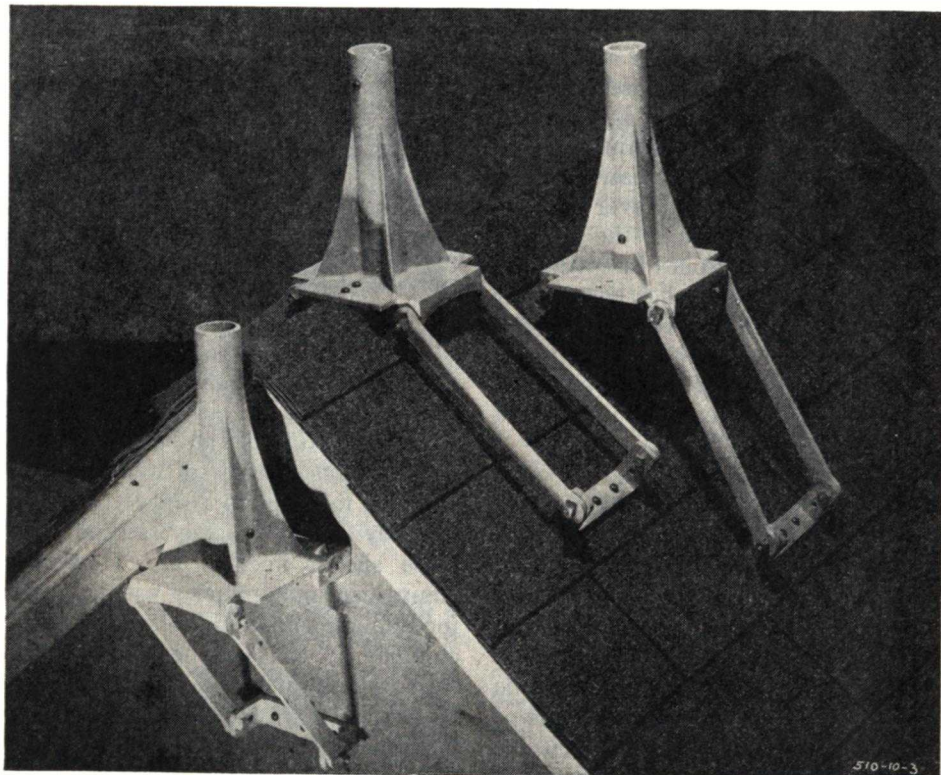


Courtesy Phoenix Electronics, Inc.

FIG. 22. A mount that makes it easy to fasten an antenna mast to a chimney.

Several kinds of smaller straps are also offered that permit a mast to be secured to a vent pipe. There is usually no objection as far as insurance policies are concerned to a mounting of this sort. There are also mounting devices on the market that permit the antenna to be mounted inside the vent pipe. These mounts are not legal in very many places, however, because there are local ordinances in almost all communities that prohibit blocking of vent pipes in any manner.

Always investigate to find out if there are any local ordinances in your community that affect the position, the mounting, or the height of an antenna. Make yourself familiar with

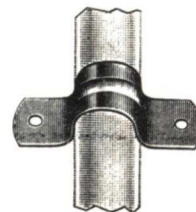


Courtesy Shure-Antenna-Mount, Inc.

FIG. 23. This versatile mount can be used to secure an antenna mast to almost any part of a roof or gable.

such ordinances before you start making installations; otherwise, you may subject yourself or your customers to fines by following some practice that is prohibited.

Antenna masts are often fastened to the roof or side of the building near the roof. An antenna mount of the kind shown in Fig. 23 can be used to mount a mast on the peak of a roof, on the side of a roof, or on the side of a building. The simple clamp shown in Fig. 24 can also be used to secure masts to the side of a building.



Courtesy Insuline Corp. of America

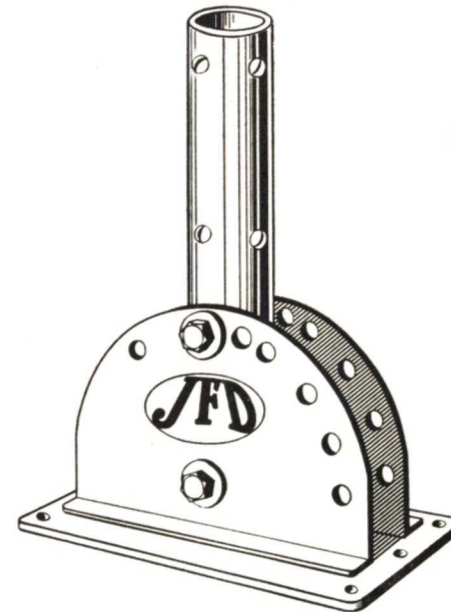
FIG. 24. Simple pipe clamps of this sort can be used to fasten a mast to the side of a building

When you are mounting an antenna mast on a roof, you should be very careful not to create leaks in the roof by running the mounting screws into it. A good way to prevent leaks is to use a thin lead washer between the head of the mounting screw and the outer surface of the mount. To make such a washer, take a small piece of lead 1/16" thick and punch a small hole in it with a nail. You can then run the screw through the piece of lead and secure a good seal that will prevent water from leaking down the shaft of the screw into the house. As an extra precaution, it is a good idea to put a dab of roofing cement under the mounting plate on the roof at the point where the mounting screw will penetrate.

It is possible to drill holes in a slate roof, but you are always taking a chance of cracking one or more of the

slates if you do so. We advise you to avoid roof mounting when the roof is slate. Instead, secure the mounting bracket or clamps to the side of the building.

An antenna mounting plate is ordinarily not secured to a flat roof. Instead, the mounting plate is secured to a heavy block of wood that acts as a base, and the antenna is held in position with three or four guy wires fastened at convenient anchor points. If the roof has a parapet, the antenna can be secured to the parapet with clamps like those used to secure it to a brick wall. The special mount shown in Fig. 25 has been developed for use with parapets, which are very com-



Courtesy J. F. D. Mfg. Co., Inc.

This base plate can be used to mount an antenna mast in almost any position.

monly found on top of apartment buildings.

Very often, particularly in areas where the signal strength is high, you can get good results by mounting the antenna in the attic. A roof in which

little metal is used, such as a slate or wood roof, does not attenuate signals much. Installations of this sort are sometimes permitted in apartment houses where roof-top installations are not. If space is available, it is wise to try the attic before attempting a difficult roof mounting job, unless you are sure that the antenna must be higher than an attic mounting will permit it to be, or unless the roof top

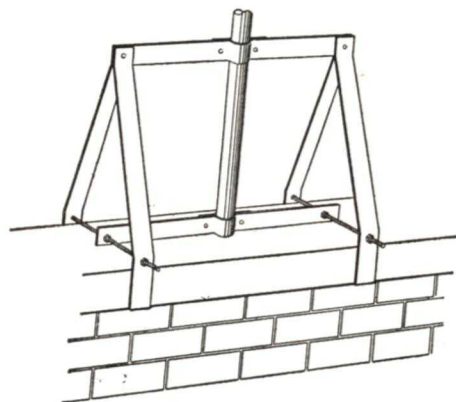


FIG. 25. A parapet mount, often useful in apartment-house installations.

is apt to be covered with snow for a considerable period. A heavy snow on the roof will attenuate considerably the signals passing through the roof.

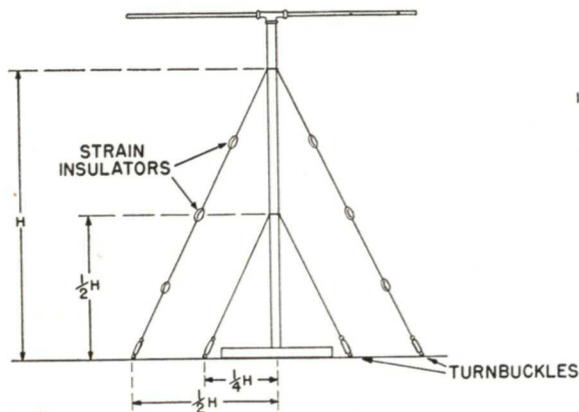


FIG. 26. This drawing shows the dimensions and locations of the guys needed to keep a tall mast in place.

Whenever you do mount the antenna outdoors, you must make sure that the mast will be strongly and firmly held. Remember that there will be considerable force exerted on the antenna when a strong wind is blowing and that it may become very heavy if snow or ice collects on it. Therefore, the mast must be held very securely.

As a protection against lightning, the antenna mast should be grounded. If its mount insulates it from ground, connect it to ground with a number 8 armored wire or a number 6 bare wire. (These are the wire sizes required by the Fire Underwriters.) Run the grounding wire straight down to a metal stake that is firmly embedded in the ground. If the mast is clamped to a vent pipe, it will be unnecessary to use a ground wire, since the vent pipe will already be well grounded. Just make sure that there is a good electrical connection between the mast and the pipe. Sometimes the ground wire is brought over from the mast to a vent pipe, when the mast is mounted somewhere near-by; however, this system does not give as good protection against lightning as does the wire run directly to the ground,

because lightning may escape from a conductor that makes a bend.

If the mast is rigidly supported at its base or supported at two or more points along its length, you will not usually need guys if its unsupported length is less than 15 or 20 feet.

If the base of the mast is not supported but is merely kept from moving by the mount, or if the mast is

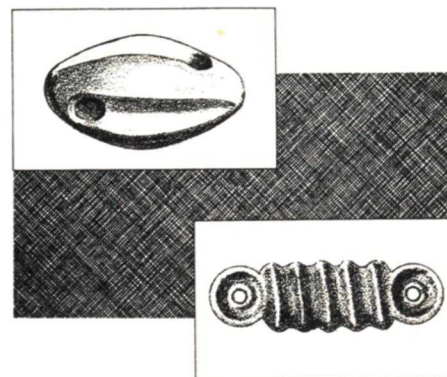


FIG. 27. The kind of strain insulator shown at the top should be used with mast guy wires. The kind at the bottom is not suitable for this use.

very small in diameter or more than 15 or 20 feet tall, guy wires should be used to keep it rigid. The sketch in Fig. 26 shows how these guys should be attached. At least three guy wires should be used at each guying point.

These guys should be made of number 6 or number 8 stranded galvanized steel wire unless the manufacturer of the antenna recommends some other size. The guys should not be continuous; to prevent them from affecting the radiation pattern of the antenna, they should be broken up at intervals that are greater or less than the length of the antenna. Strain insulators of the kind shown at the top of Fig. 27 should be used to break them up. This insulator is made so that the two sections of the

guy wire that pass through it are interlocked (although separated by the insulator); thus, if the insulator should break, the guy wire will not come apart. The kind shown at the bottom of Fig. 27 should not be used, because the guy wires will part if it breaks.

There should be a turnbuckle in each guy wire so that it can be tightened after the mast is erected. A guy should not be brought to its final tightness with the turnbuckle the first time it is adjusted; instead, each guy should be tightened in turn until all are moderately tight and tightened in turn again until each is at its final tautness.

TALL MASTS

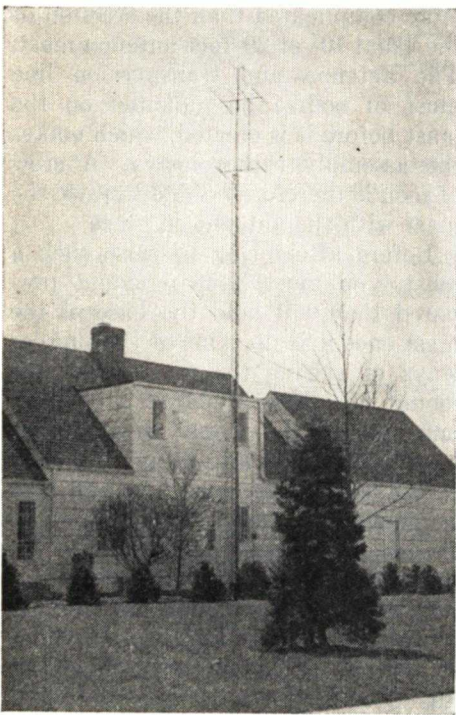
The erection of a tall mast is much more complicated than the erection of the usual 10- or 20-foot antenna mast. The antenna and transmission line must of course be mounted on the mast before it is erected, which makes the assembly rather heavy. A crew of men is therefore needed to raise the mast with the antenna in place.

Before attempting to raise such a mast, you must have a mount prepared that will hold the base of the mast once it is up. One of the simpler ways of raising the mast after this mount has been prepared is to have one man at the mount to guide the base of the mast into it, another close to the base of the mast who will help in getting the mast started up and then help the first man to guide the mast into its mount, and at least one man on each guy to pull the mast up and to keep it from toppling over after it is erect. Since the mast should be guyed every 10 or 15 feet, and since there should be at least three guy wires at every guying point, some six or nine men will be needed to pull up a 40-foot mast.

Anchors should be provided before the mast is erected so that the guys can be quickly secured once the mast is up. Of course, turnbuckles should be installed in each guy so that it can be tightened.

The mast, of course, should be of strong enough material to be able to hold itself up without bowing. Two-inch pipe is probably strong enough for a 40-foot mast; if the mast is to be much taller than this, either a very heavy pipe or some form of lattice work construction of light pipe or wood should be used.

There are two schools of thought on the subject of how high the top guys of the mast should be. If the mast is to remain rigid, it should be guyed very near the top. Some engineers,



Courtesy Alprodeco, Inc.

A mast is often secured to the side of a house, as shown here, to simplify the problem of supporting it.

however, feel that the top guys should be about 10 feet below the top of the mast. If this latter construction is used, the mast top will sway in a high wind, but it will not break, whereas the rigid mast may be knocked over when the wind becomes very strong. If the place where the antenna is erected is swept by high winds, the construction that permits the mast to sway slightly is probably better.

MOUNTING THE ANTENNA

Usually the antenna must be mounted on the mast before the mast is put in place. At what point in the procedure this should be done depends upon what kind of installation is being made. If it is a simple roof mounting, often the easiest thing to do is to carry the unassembled antenna up to the roof, assemble it there, mount it on the mast, secure the transmission line to it, and then erect the mast. Of course, this may be something of a job if the roof furnishes only a precarious perch.

Some antennas are designed so that they can be folded until it is time to erect them. Such an antenna can be mounted on the mast on the ground, then the whole assembly can be brought conveniently up to the roof, and the antenna can be snapped out to its final position just before the mast is erected. An antenna of this sort, if it is designed so that it cannot fold up again after the installation is completed, can be a very great time saver.

If the antenna is to be mounted on clamps secured to the side of the building, mounting the antenna on the mast becomes something of a problem. It may be possible to mount the antenna on the mast on top of the roof, then carry the whole assembly over to the side of the house where it is to be mounted. At other times, it

may be necessary to mount the antenna on the mast on the ground and then carry the assembly up a ladder. Either procedure may be rather dangerous, so the installing crew should exercise great care in making such an installation.

As we mentioned earlier, the antenna must be mounted on a tall mast before the latter is erected. If a tower is used, it may be possible to climb it afterward and mount the antenna on the peak of the tower, but it is usually a dangerous and difficult task to do so.

ANTENNA ROTATOR

When an antenna rotator is to be used, it must first be clamped on the top of the mast; the antenna must then be installed in the movable section of the rotator. This will, of course, have to be done before the mast is erected. The only extra problems the rotator creates are that it adds weight to the top of the mast and that it must have a power lead brought to it. A suitable power and control line is generally supplied with the device.

RUNNING TRANSMISSION LINES

A transmission line must be secured to the antenna mast or mounting somewhere close to the point at which the line is electrically connected to the antenna. A line should never be allowed to hang free from the antenna, because it will eventually break loose. Often some form of clamp is provided on the antenna or on the mast to remove all strain from the connections themselves. One such strain relief clamp is shown in Fig. 28.

Ordinary twin-lead line is very easily secured to the antenna. All you need to do is to split the insulation in the middle and strip it from the

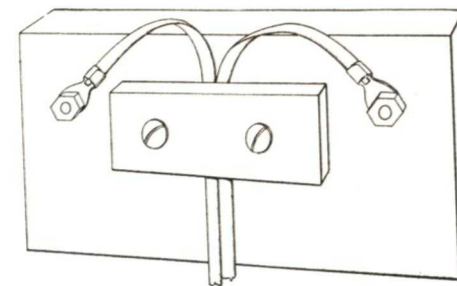


FIG. 28. A typical strain relief clamp. Some such clamp should always be used near the point at which the transmission line is connected to the antenna to prevent the weight of the line from damaging the connections.

leads with a knife. The leads can then either be wrapped around the terminals of the antenna and bolted or be fitted with lugs that can be slipped over the antenna terminals. The latter method is usually preferred.

Shielded lines are somewhat more difficult to connect to the antenna because of the presence of the braid. One of the best ways of separating the braid from the inner conductor of a coaxial line is shown in Fig. 29. To prepare a coaxial cable this way, first strip off about 6 inches of the rubber outer covering (Fig. 29A). Next, push the braid apart with an ice pick or some other pointed tool at a point about an inch from the end of the outer insulation (Fig. 29B). Next, bring the inner conductor out through the hole thus formed in the braid (Fig. 29C). Stretch the braid by pulling on its end until it closes tightly around the inner conductor. Finally, solder lugs to the end of the braid and to the end of the inner conductor (Fig. 29D).

Shielded 300-ohm twin lead requires even more elaborate treatment so that water will not run down inside it. The steps to follow to prepare the end of one of these lines for connection to an antenna are shown in Fig. 30. First,

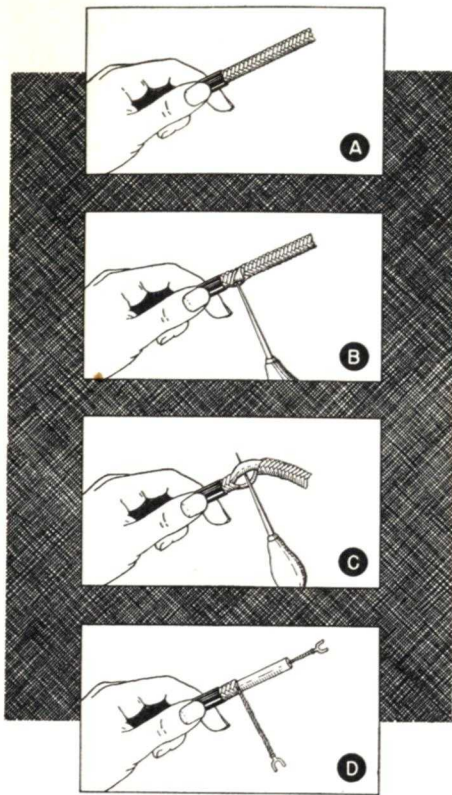


FIG. 29. Steps in fitting terminals to the conductors of a coaxial cable.

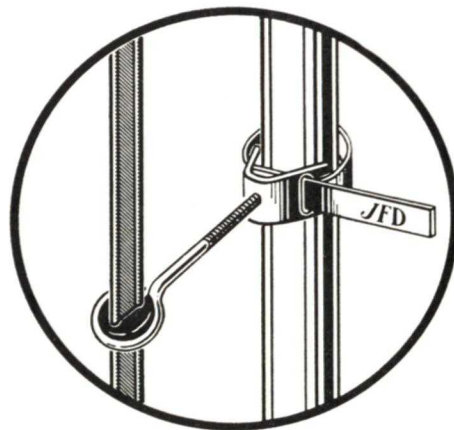
remove 3 inches of the outer jacket from the end of the line (Fig. 30A). Next, remove a 2-inch length of the copper braid (Fig. 30B). Pull the remaining inch of braid back over the outer jacket (Fig. 30C). Solder a pigtail of No. 18 wire to the braid, using a length that will leave at least 4 inches of the pigtail free. Strip an inch of the polyethylene insulator from the leads (Fig. 30D). Next, close the end of the cable with Scotch electrical tape (Fig. 30E) to keep water out of the jacket (this is often called "serving" the line). If you prefer, you can apply a coat of some waterproof plastic, such as polystyrene dope, over the exposed ends. Slip solder lugs over the tubing and solder

the leads to the lugs, using a minimum amount of heat so that the polyethylene will not be injured. Follow this procedure for both ends of the lead-in.

A shielded line, either coaxial line or shielded 300-ohm twin lead, can be secured directly to the antenna mast. Unshielded twin lead, however, should be spaced out from the mast to prevent its characteristics from being affected by the near presence of the metal of the mast. Masts supplied with antennas often have rubber spacers for this purpose.

The transmission lines should be led as directly as possible from the antenna to the receiver. Unshielded twin-lead line should be twisted once every foot, to reduce pickup of local interference; shielded line can be run straight.

Whenever possible, it is advisable to bring the line in through the basement and through the floor in back of the set. This will make it unnecessary to run long lengths of line through the house. To make an installation of this sort, the line may be brought down the side of the house



Courtesy J. F. D. Mfg. Co., Inc.

This stand-off insulator is used to space twin-lead line away from an antenna mast.

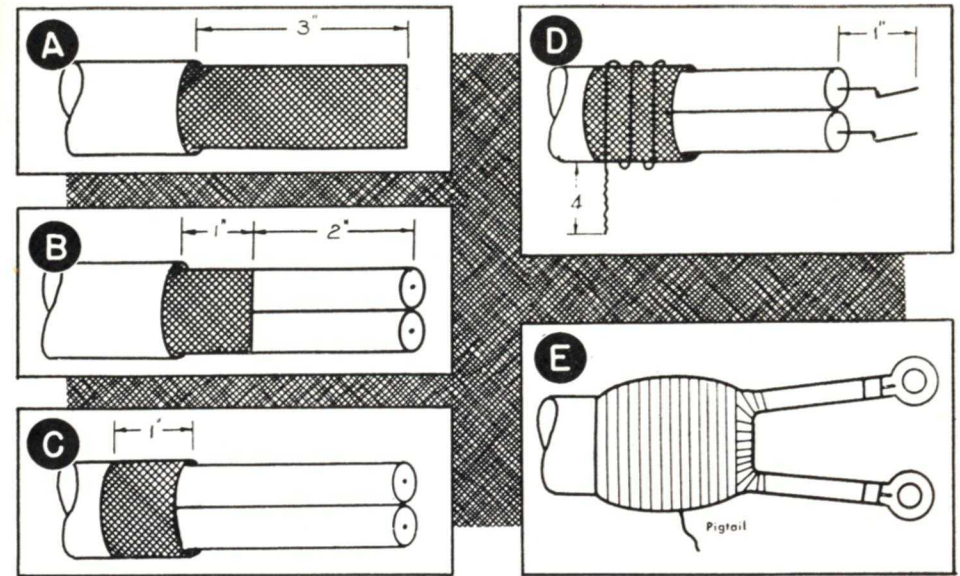


FIG. 30. Steps in preparing the end of a shielded twin-lead line for connection to an antenna.

to a basement window. You can then drill the casement of the window and bring the line in through it. Just before the line is brought into the house, a lightning arrester should be inserted in it. You can then bring the line over from the window to the point where the hole is drilled in the floor at the rear of the set.

The owner may prefer the transmission line to be brought directly into the room in which the set is located without going through the basement, or the installation may be made in a house that has no basement. If so, bring the line through a hole drilled in the casement of the window, mounting the lightning arrester inside the window. Lead the line to the set from the window along the baseboard. If it is a shielded line, secure it to the baseboard with staples; if it is unshielded twin lead, you can drive fiber-headed tacks through the center of the insulating ribbon to secure it.

Twist unshielded line once each foot to reduce pickup of local interference.

Whenever you drill a hole through the casement of a window to bring a transmission line through, be sure to slant the line downward from the inside of the house. This will prevent rain from coming in along the line.

It may be possible to bring unshielded twin lead in between the two halves of the window in the manner described earlier for a window antenna installation. This will make it unnecessary for you to drill a hole through the casement.

A shielded line can be secured to the side of the house without fear that its characteristics will be changed thereby. Unshielded twin-lead line, however, should be fastened to the house with stand-off insulators. The type shown in Fig. 31 is well suited to this use. If the house has masonry walls, you must drill holes and insert plugs in them for the screws in these

insulators. Insulators of this sort should be installed before the transmission line is brought down, and they should be placed so they will be directly along the path that the line is to follow.

The location of the transmission line with respect to its surroundings is often important. In addition to being



Courtesy Phoenix Electronics, Inc.

FIG. 31. Stand-off insulator for twin-lead line.

run as directly as possible from the antenna to the set, the line should also be removed as much as possible from sources of interference. For example, a transmission line brought down the back of a house away from the street is much less likely to pick up ignition interference than is one that is brought down the street side of the house. It is also wise to make sure that the transmission line is not in some location where it can be damaged easily—in particular, it should be kept out of reach of children.

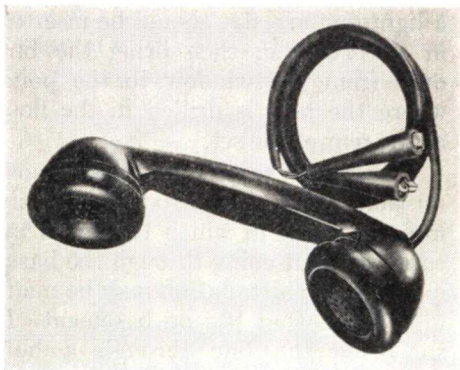
ORIENTING THE ANTENNA

When an antenna has been installed and connected to a set, it must be oriented to produce the best possible reception from each of the stations in the vicinity. If the antenna is equipped with a rotator, of course, finding the right orientation is no problem; the customer will turn the antenna to bring in the best picture each time he tunes in a different station. If the antenna is to remain in one place, however, it must usually be carefully oriented before the installation is completed so that the reception on all stations will be equally good.

Orientation of the antenna is generally a two-man job. There must be one man on the roof to turn the antenna, and there must be another at the receiver to watch the effect of turning it. These two men must have some way of communicating with one another so that the man turning the antenna can learn what happens when he turns it. A telephone like that shown in Fig. 32 is frequently used for this purpose.

This particular telephone is sound operated. A sound-operated telephone is equipped with a high-output magnetic microphone that is capable of operating a telephone receiver over a considerable distance without amplification. The chief advantage of such phones is that they require no external power source. Conventional battery-operated telephones are, of course, perfectly usable.

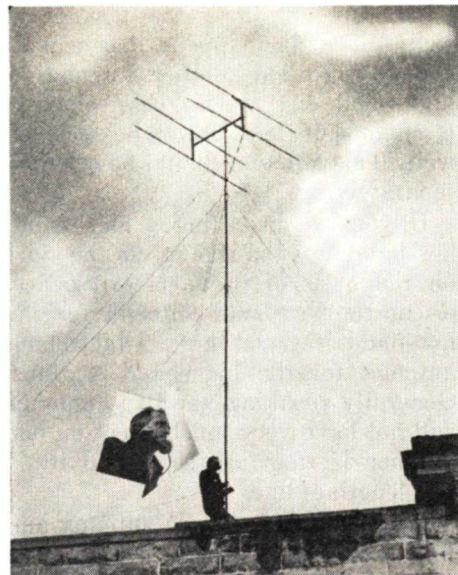
Some installation crews clip their sound-powered telephones across the ends of the transmission line, thus



Courtesy Wheeler Insulated Wire Co., Inc.

FIG. 32. A sound-powered telephone handset.

saving themselves the trouble of having an extra inter-connecting line between the antenna position and the set position. However, it is often inconvenient to do this, since the end



Courtesy Wheeler Insulated Wire Co., Inc.

Sound-powered phone in use during orientation of an antenna.

of the transmission line at the antenna may be many feet in the air; further, connecting the telephone across the line may affect the characteristics of the line and thus impair the quality of the picture, thereby making it difficult to judge how good the picture is. For this reason, we recommend that you have a separate connecting line between the two telephones.

There are many possible systems you can use to find the right orientation for the antenna. The one we are going to describe, however, is easy to follow and has proved to be very satisfactory.

Let's assume that you are the man turning the antenna. First, orient the antenna so that it receives best from the north (that is, if it is a dipole, point its rods east and west), and have your assistant at the receiver tune in the lowest-frequency station that can be received. Then have your assistant describe the quality of the

picture to you as you rotate the antenna. For example, as the antenna is rotated, your assistant may make a report something like this: "Faint picture. Getting better—better—good picture—getting worse—no picture."

You must keep a record of picture quality versus antenna position as you rotate the antenna. A convenient way to do so is to use a chart like the one shown in Fig. 33. Mark a heavy line on the chart to represent the direction the antenna is turned when the reception is reported to be good, and make a broken line to show those directions in which the picture is reported to be poor or non-existent. If the picture is reported to have ghosts in it, draw a wiggly line to show the directions in which the ghosts appear.

After you have made a complete rotation of the antenna in this manner, you will have a chart that shows how well the antenna receives that particular station in each of its possible positions. Next, repeat the process with the station next higher in frequency tuned in. Draw another line outside the first one to show how well the second station is received.

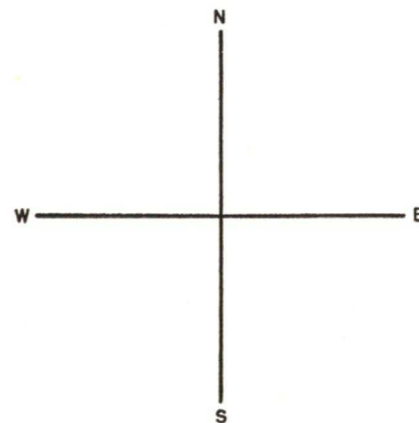


FIG. 33. Use a simple chart of this sort to help you determine the best orientation.

If there are more than two stations, repeat the process again for each.

The completed chart for a location in which four stations are present might look something like the one shown in Fig. 34. This indicates that a clear, ghost-free signal can be gotten from three stations in the position marked A, but that the fourth station cannot be picked up there or in any other position in which the

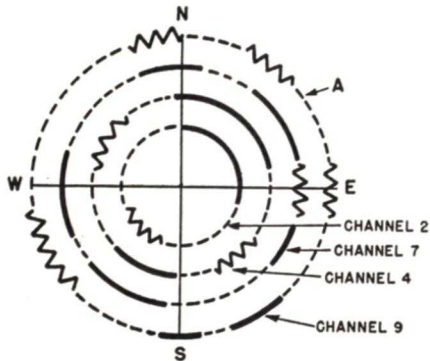


FIG. 34. How the filled-out orientation chart might appear after you have made reception tests at a location.

other three stations are picked up well. When this happens, it is usually necessary to add another antenna—a high-band one in this case, since it is channel 9 that cannot be received well. This antenna should be oriented separately.

If you are installing a high-band, low-band antenna right from the start on the basis of previous experience, orient the low-band antenna for the low-band stations and the high-band antenna for the high-band stations. Generally speaking, the two antennas will not have very much effect on one another if they are separated by a $\lambda/4$ length of line.

If you install a single antenna and find it necessary to use a high-band antenna in addition, you can get a high-band attachment that you can clamp on the antenna mast. This will be far more convenient than it would be to install a separate antenna or to replace the antenna with a high-band, low-band combination.

Lesson Questions

Be sure to number your Answer Sheet 60RH-3.

Place your Student Number on every Answer Sheet.

Send in your set of answers for this Lesson immediately after you finish them, as instructed in the Study Schedule. This will give you the greatest possible benefit from our speedy personal grading service.

1. What are usually the two chief problems in primary-area antenna installations? *ghosts (reflections), multi channel reception pg 3, 6*
2. When may a directional antenna like the one shown in Fig. 4 be used? *pg 7*
3. Why are antenna rotator motors usually operated from 24-volt a.c.? *pg 8*
4. What is the effect on reception of using a 300-ohm line with a plain dipole in an area where the signal strength is high? *pg 9*
5. In investigating the signal strength in a fringe area, why is it better to connect a TV set to your test antenna than to use a meter to measure the antenna pickup? *pg 16*
6. If a house has a slate or tile roof, where should you secure the antenna mount if an outdoor antenna is needed? *pg 27*
7. Why should guy wires used with antenna masts be broken up by insulators instead of being continuous? *pg 29*
8. Why is it important to "serve" the end of a shielded 300-ohm line at the antenna end? *pg 31, 32*
9. Why should you twist unshielded 300-ohm line once every foot? *pg 32*
10. In a city installation, why is it better to lead the transmission line down the part of the house that is farthest from the street? *pg 34*

Be sure to fill out a Lesson Label and send it along with your answers.



MAKE DECISIONS

It is a very fine thing to have an "open mind." But it is a fine thing **ONLY** if you have the ability to make a *decision* after considering all sides of a question.

Failure to make a decision after reasonable consideration of all facts will quickly mark a man as being unfit for any position of responsibility.

So practice making clearcut, well thought-out decisions.

Not all your decisions will be correct. No one is perfect. But if you get the habit of making decisions, experience will develop your judgment to a point where more and more of your decisions will be right.

J.E. Smith