

**ACOUSTICS IN  
PUBLIC ADDRESS WORK**

REFERENCE TEXT 54RX



**NATIONAL RADIO INSTITUTE**

**WASHINGTON, D. C.**

**ESTABLISHED 1914**

# STUDY SCHEDULE

- 1. Introduction .....Pages 1-3  
The nature of the basic acoustical problems found in p.a. work are outlined in this section.
  
- 2. Microphones and Their Characteristics .....Pages 3-16  
Here the construction and operating characteristics of all the types of microphones now used are described.
  
- 3. Loudspeakers and Their Enclosures .....Pages 17-23  
This section contains a description of the kinds of baffles used with loudspeakers in p.a. work and of the sound distribution patterns that each produces.
  
- 4. Practical Acoustics .....Pages 24-31  
Here you learn how the hearing characteristics of the human ear affect the design of a p.a. system and how the problems created by reflections of sound in an indoor installation are solved.
  
- 5. Determining Acoustical Powers Needed .....Pages 32-36  
In this section you learn how to use the various factors discussed in the earlier parts of this Lesson to determine how much power is needed in a particular installation to produce the desired response.



**B**EFORE it is possible to choose an amplifier for a particular location, it is necessary to have at least a general knowledge of some of the acoustic problems involved in public address work. Acoustics—the study of sound and its effects upon hearing—is considered to be a science, but is more of an art as it is practiced in p.a. work. That is, although it is possible to make carefully controlled scientific measurements of the conditions in a particular installation, such a scientific survey would be costly and would be of little use unless it were made under the exact conditions that exist when the equipment is in use. Therefore, in practice, acoustic problems in p.a. work are solved by using good judgment and past experience to a large extent. As we shall show later, certain tabulated information on acoustics is available that is helpful in planning an installation, but each job usually brings up its own special problems. Let's see what some of them are.

Sound reflection and absorption cause trouble in indoor installations. Sound waves bouncing from wall to wall cause different effects, depending

on the lengths of the paths traveled. Sounds coming from two directions to a particular spot may arrive  $180^\circ$  out of phase, with the result that the sound energy cancels, producing what is known as a dead spot. They may also arrive  $360^\circ$  out of phase, producing sound reinforcement. (There are several noted "whispering galleries" in which a whisper uttered in one spot can be heard at another spot perhaps 50 feet away, but nowhere else. This effect is the result of sound reinforcement.) Most commonly, the sounds are only partly out of phase; the result of this is usually that the sound is muddled and made hard to understand.

If the reflection path is long enough, there will be a complete echo—that is, the sound will arrive so much later over the longer path that it can be heard twice. This, too, is troublesome.

Another effect associated with reflections is reverberation. This occurs when there are many sound-reflecting surfaces in a room, as a result of which a sound is reflected many times and therefore takes a relatively long time to die out. The reverberation pe-

riod of a room is measured by how long it takes a sound to drop 60 db from its original loudness. If this time is excessive, any continuous series of sounds produced in the room will seem extremely jumbled to a listener.

Another factor that varies from installation to installation is the surrounding noise level. This level plays an important part in determining the amount of power needed, because the p.a. system must have enough output to keep the average sound level well above the noise.

Absorption also creates problems. The system that sounds all right in an empty auditorium may not give enough power when the audience is present, because sound is absorbed by the clothing worn by the audience.

Outdoors, sound energy is rapidly dispersed even on a still day, because there are no containing walls to keep it in. If there is much wind, the sound dispersal is even more rapid. Noise is a problem outdoors also, of course.

All such factors must be considered before an installation is completed. As far as possible, they should be considered before the installation is even started; however, it is usually impossible to do much about reflections until the equipment is at least temporarily installed. (Reverberation, a special case of reflections, can be cured before installation of the equipment.) You can see, then, that far more is involved in making a p.a. installation than just setting up an amplifier, a few loudspeakers, and a microphone or two. The job must be carefully planned so that the installation will be adequate for its intended use but not so unnecessarily powerful that it is more expensive than it should be. Remember that the cost of an amplifier goes up directly with the power rating, because naturally more expensive power and output

transformers must be used, as well as parts that have high wattage ratings.

## PLANNING A P.A. SYSTEM

The purpose for which a p.a. system is to be used must be considered first of all when you are planning its installation. If the system is to be used only for paging or announcing, it should be designed to handle only the limited frequency range of the human voice: in this case, the system can be fairly inexpensive. If the system is to handle music, however, at least a fair degree of fidelity over a much wider frequency range will be necessary. This means that the microphones, amplifiers, and loudspeakers will have to be capable of delivering the required frequency range, and in general, that more power output will be required, as we shall show later.

Next, it is necessary to consider the location. It is possible to determine arbitrarily the amount of sound power that will be necessary to fill a certain cubic volume, so if we know the length, breadth, and height of a room, we can determine roughly what sound or acoustic power will be needed to fill it adequately with sound. To this basic amount, we must add enough power to overcome the average noise level plus enough more power to overcome the effects of absorption and dispersal. Then, once we have determined the acoustic power that will be needed, we can work backwards to find how much electrical power will be necessary. Certain specific kinds of loudspeakers and baffles may have to be used to meet the fidelity requirements, as we shall show later in this Lesson. Knowing the efficiency of these loudspeakers, we can determine how much electrical power output our amplifier has to have to produce the acoustical power needed. This sets the amplifier size.

Now that we have certain kinds of loudspeakers and an amplifier chosen, we must turn to the input. The number of microphones required depends on the conditions that are to be met. If the system is to be used for a large orchestra or to amplify the voices of actors who may be at different points on a large stage, a number of microphones may be needed. Very often, on the other hand, only a single one will be necessary. The types of microphones to use will depend on the fidel-

ity wanted, on how rugged they must be, and on how necessary it is that they pick up only the desired sounds and ignore others.

Before we get into the acoustical problems of p.a. installations and learn exactly what must be done to solve them, we need to know more about the characteristics of loudspeakers and microphones. Let's take time out to study these two devices now.

## Microphones and Their Characteristics

A public address amplifier may operate from a phonograph pickup, from a radio tuner that feeds a radio program to it, or from a microphone. The phonograph pickup and the radio tuner are covered elsewhere, so we shall consider only the microphone here. Incidentally, the microphone is the only one of these that brings up the problem of acoustic feedback, which we are going to study.

Any microphone is simply a device that will transform sound energy into electrical energy. Basically, all microphones contain some form of diaphragm—a movable cone, a plate, a ribbon, or the face of a crystal. When

sound waves strike this diaphragm, the variations in air pressure cause it to move; its motion is used to set up an electrical current that varies correspondingly.

Let's examine the various types of microphones to learn something of their physical construction.

### CARBON MICROPHONES

Essentially, the carbon microphone consists of a diaphragm that is in contact with either one or two "buttons" consisting of small packages of loose carbon granules or grains. Fig. 1 shows a cut-away view of a double-button type—one that has a button on each side of the diaphragm. A single-button type, of course, has only one button.

The diaphragm is a very thin metal plate, the edges of which are clamped in a ring assembly. The plate is so flexible that it vibrates when sound waves strike it. When it moves in on the package of carbon grains, they are pressed tightly together; when the diaphragm moves away from a button, the carbon particles separate or loosen up. When the carbon grains are pressed together, they make better

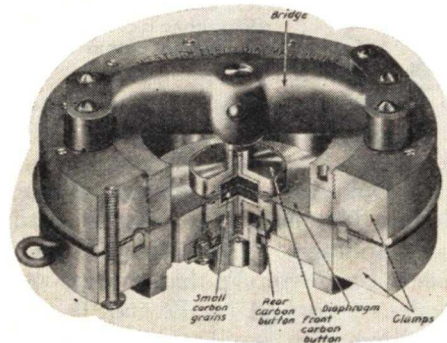

Courtesy Western Electric

FIG. 1. The construction of a double-button carbon microphone.

electrical contact and the resistance through the button decreases. Conversely, the resistance through the button increases when they are allowed to be looser. In other words, the resistance of the buttons varies as sound waves strike the diaphragm;

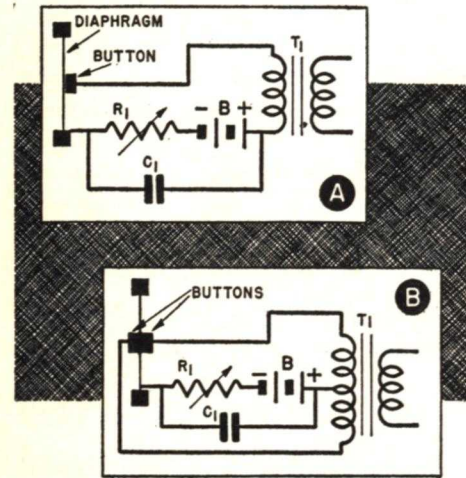

FIG. 2. How carbon microphones are connected to produce an output signal. The single-button type is shown in A, the double-button in B.

This varying resistance can be made to vary the current in a circuit by connecting the buttons in series with a battery.

The electrical connections for both single and double-button types are shown in Figs. 2A and 2B, respectively. In each circuit, the resistance  $R_1$  is used to adjust the current to the desired initial value. Then the microphone causes the current to increase and decrease above and below this starting value in step with the sound waves. This varying current flowing through the primary of transformer  $T_1$  induces a voltage in the transformer secondary; this voltage becomes the signal output of the microphone and can be fed to the grid of the first amplifier stage, either directly or through a transmission line. The

transformer is necessary to match the low impedance of the microphone (200 to 500 ohms) properly to the transmission line or the grid of the first amplifier tube.

The double-button type is capable of giving better frequency response than the single-button. Both carbon microphones are relatively noisy compared to other types, however. Tiny sparks are formed as the carbon grains press together or loosen up, with the result that there is always an appreciable noise output. Although the carbon microphone gives a greater output than any other type, this noise trouble, and the need to use a rather large battery with it, have led to its almost complete disappearance from public address work. Today the only carbon microphones you're likely to find are certain hand-held microphones of the telephone type.

### CONDENSER MICROPHONES

The condenser microphone, shown schematically in Fig. 3, is essentially a condenser whose two plates consist of a flexible diaphragm and a fixed plate. In Fig. 3, the diaphragm D is held in the clamp rings R, much as is

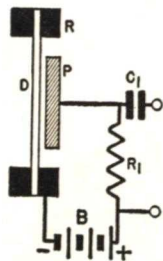
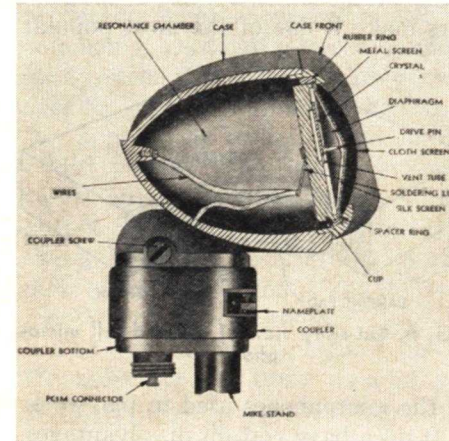

FIG. 3. How a condenser microphone is connected to produce an output signal.

the diaphragm of a carbon microphone. The plate P is very close to the diaphragm. The battery B furnishes a high voltage that charges the condenser formed by D and P. As the diaphragm is vibrated by sound waves, it alternately approaches and moves away from the plate P. This

increases and decreases the capacity. For a fixed voltage, the amount of charge that can be held by a condenser depends on its capacity, so this variation in capacity obviously changes the amount of charge stored in the microphone. Hence, a varying



Courtesy The Turner Co.

FIG. 4. Cut-away view of a crystal microphone.

current flows through  $R_1$  as the charge increases and decreases. The varying voltage drop across  $R_1$  is the signal output of the microphone; this is fed out through the coupling condenser  $C_1$ .

Since the capacity of the condenser microphone is very small, the current change caused by movements of the diaphragm is measured in microamperes. As a result,  $R_1$  must be very high in resistance for there to be an appreciable signal voltage. This means that the microphone must feed into a very high impedance for there to be an efficient signal transfer; as you know, any such high-impedance connection would be subject to hum and noise pickup if there were any considerable length of line between the microphone and the amplifier. Because of this fact, and because of the low output of the microphone, it is necessary to have a preamplifier right

at the microphone; customarily, as a matter of fact, it is built into the microphone housing. Therefore, the housing must be rather large. Furthermore, the charging voltage for the microphone must be fairly high and must be pure d.c. if hum is to be avoided. Therefore, either batteries or an exceedingly well-filtered power supply is required.

Since a preamplifier is always a part of the microphone unit, it is customary to rate the output of a condenser microphone in terms of the preamplifier output. The condenser microphone therefore delivers a comparatively large output. However, its bulky nature and critical power-supply requirements make this a relatively unpopular type for p.a. use.

### CRYSTAL MICROPHONES

Fig. 4 shows a cut-away view of a typical crystal microphone, and Fig. 5 shows its operational details. Once again we have a diaphragm that is clamped in a retaining ring. This diaphragm is coupled mechanically through a drive pin to a pair of Rochelle salt crystals. These crystals

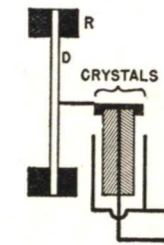

FIG. 5. How a crystal microphone is connected to produce an output signal.

are very similar to the ones used in phonograph pickups. Two crystals are used, connected back to back. One terminal of the microphone unit is a tinfoil plate in contact with the two crystals where they join. On the outside of each crystal there is another plate; these plates are connected to form the other terminal.

Rochelle salt crystals exhibit what is known as the "piezo-electric" effect, meaning that a voltage will appear on the opposite faces of the crystal if the crystal is mechanically stressed in any way (or, conversely, that the crystal will be temporarily deformed if a voltage is applied to its opposite faces). In this unit, one edge of the crystal assembly is clamped tightly in the case and the other edge or corner of the assembly is secured to the diaphragm. As the diaphragm moves back and forth, the crystals are bent or twisted, which causes them to generate a voltage.

Fig. 6 shows another form in which a crystal microphone may be manufactured. In this unit, known as a "sound cell," groups of crystals are cemented into frames. The diaphragm and driving pin are dispensed with and the crystal units are acted upon directly by the sound waves.

Because the surface that is worked on by the sound waves is less in this microphone, the output is smaller than it is in one using a diaphragm.



Courtesy Shure Bros.

This shows what a typical crystal microphone looks like.

However, the sound cell microphone is less affected by shock and vibration than is the diaphragm type, so it is popular in uses where it may be subjected to rough handling.

The crystal microphone is relatively rugged, and is less expensive than some of the other types. These factors make it one of the most popular

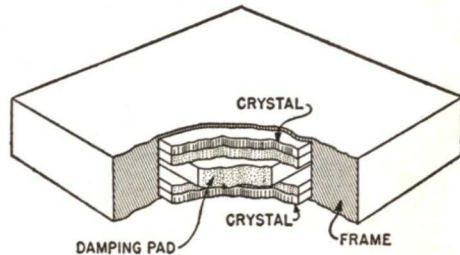

FIG. 6. Cut-away view of a sound-cell microphone.

of the microphones used in p.a. work.

It does have certain disadvantages, however, chief of which is that the crystals can be destroyed by very rough handling or by high temperatures. A crystal microphone cannot be used, therefore, in any location where conditions of high heat may exist. It is not a good microphone for use in a sound truck or for outdoor locations where the sun may get to work on it.

In the cut-away view in Fig. 4, there is a space in the microphone case marked "resonance chamber." We'll explain the purpose of this shortly.

### DYNAMIC MICROPHONES

The dynamic microphone is almost the same as a p.m. dynamic loudspeaker, except that the cone is replaced by a diaphragm. Figs. 7 and 8 show the details of a typical one. A voice coil is placed in an air gap so that it is in a very strong magnetic field. When the diaphragm is actuated by sound waves, the voice coil (which is secured to the diaphragm)

is forced to move in and out through the magnetic field; as a result, a voltage is induced in the coil. This is passed on through a transformer mounted in the case to the output terminals.

As a matter of fact, a small p.m. dynamic speaker makes a relatively acceptable microphone—this idea is commonly used in intercommunication systems where the dynamic loudspeaker acts as a microphone when the appropriate switch is set in the "talk" position, but then is switched to be an actual loudspeaker at the output of the amplifier when the switch is allowed to return to its normal "listen" position. You'll learn more about this elsewhere.

The dynamic microphone is one of the most popular types used in p.a. work. It costs somewhat more than the average crystal microphone but is very rugged. It can be used where temperature and humidity conditions make the crystal type unsuitable.

Although the dynamic microphone is not commonly a high-fidelity microphone, it can be made to have a good frequency response, as we shall see.

### AIR-RESISTANCE LOADING

In all of the microphones discussed so far except the sound cell, a dia-

phragm is used to convert motions of air particles into mechanical motion that may be used to generate the desired electric current. All such diaphragms contain sufficient material to have a certain amount of mass, and they are mounted so that the natural springiness of the material will tend to restore it to its original shape when

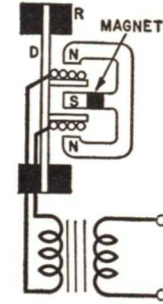
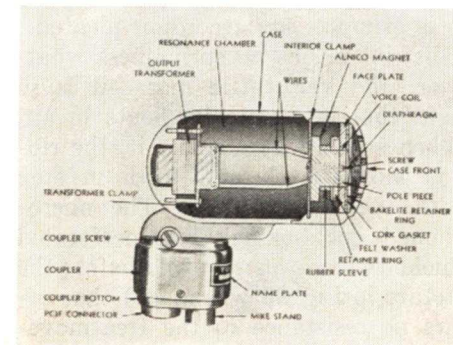

FIG. 8. How a dynamic microphone is connected to produce an output signal.

sound pressure is removed. Since it has mass and springiness, which are the mechanical equivalents of inductance and capacity respectively, the diaphragm has a resonant frequency at which it will vibrate most readily. This resonant point is quite likely to occur in the audio spectrum, with the result that the microphone will exhibit a very undesirable peak in its response.

To a great extent, this peak can be ironed out by enclosing the back of the microphone so as to form an air chamber. A cut-away view of this arrangement in one form of dynamic microphone is shown in Fig. 9. A small tube, or vent, connects the air chamber to the outside air. You can understand the function of this vent readily if you have ever used a pump of the sort used to inflate footballs. Such a pump has a small, removable, hollow needle at one end through which the air being pumped out must pass. It is appreciably harder to pump air through this needle than it is to operate the pump with the needle



Courtesy The Turner Co.

FIG. 7. Cut-away view of a dynamic microphone

removed. The reason is that the small opening offers considerable resistance to the movement of air through it.

By the same token, the small vent in the air chamber of the microphone in Fig. 9 does not pass air readily. Thus, when the diaphragm in this microphone moves inward, part of the energy of its motion is absorbed in forcing air out through the vent. If we again consider the diaphragm to be a resonant device, we can say that the air chamber and vent add resistance to the circuit. You know that adding resistance to an electrical resonant circuit reduces its output at the resonant frequency; similarly, the addition of this acoustical resistance to our mechanical-acoustical circuit reduces the tendency of the diaphragm to vibrate at its resonant frequency. As a matter of fact, it is possible to eliminate resonant effects almost completely by designing the air chamber and vent properly.

The cut-away views in Figs. 4 and 7 show the air chambers. Although Fig. 9 shows a dynamic microphone, the same general principle can be made to apply to others with diaphragms. Such microphones are called "pressure" microphones, because the voltages they generate are directly proportional to the pressures of the sound waves striking them.

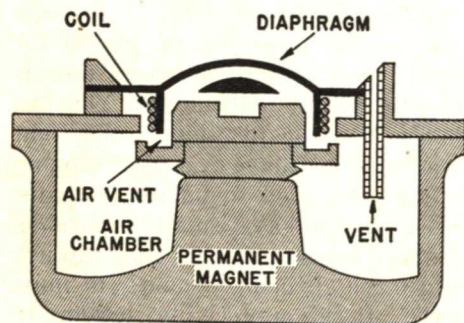

FIG. 9. Cut-away view showing the resonance chamber and vent in a dynamic microphone.



Courtesy RCA

FIG. 10. A typical velocity microphone.

### RIBBON MICROPHONES

The ribbon microphone, shown in Figs. 10 and 11, is rather different from the types we have discussed so far, because it has no circular diaphragm. Instead, a very thin ribbon of an aluminum alloy is suspended between the poles of a powerful magnet. The ribbon is clamped at its ends, where connecting wires attach it directly to a matching transformer. The ribbon completes the primary circuit of this transformer and therefore acts as a 1-turn coil. When it moves in the magnetic field, a voltage is induced in it.

To permit movement of the ribbon, it is crimped or "accordion pleated." This ribbon has no springiness whatever, and very little mass—it is so light that it practically floats in air. When sound waves strike it, the ribbon moves back and forth in step with the air particles. The microphone is enclosed only by a perforated shield (which was removed before the picture in Fig. 11 was made) that offers no resistance to the free movement of air in and out.

Since the ribbon moves in step with

the moving air particles just as if it were an additional air particle, it is said to respond to the velocity of the air particles rather than directly to the actual pressure of the wave. For this reason, you'll find that the ribbon microphone having both the front and back of the ribbon exposed to sound waves is called a "velocity" microphone.

**Pressure Type.** It is possible to make the ribbon microphone respond to sound pressure like other microphones, however, by enclosing the back of the ribbon in an air chamber. Fig. 12 shows the most common way of doing this. A pipe is used to enclose the rear surfaces of the ribbon completely. This pipe then leads down into a box at the bottom of the microphone where there is an air chamber. Enclosed on one side in this manner, the ribbon acts like a diaphragm, so the microphone becomes a pressure-actuated device.

The ribbon microphone is rarely used in p.a. work, because of its extreme delicacy. A single gust of wind, or a sharp puff of air from a person speaking directly into one, will un-

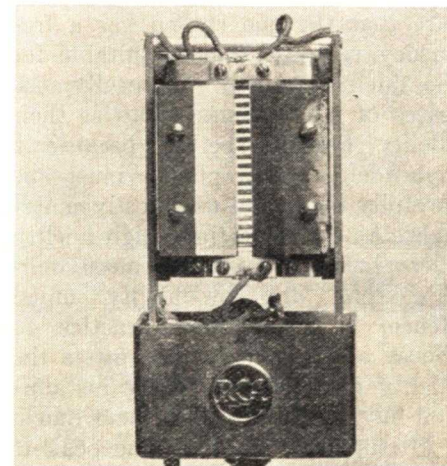

Courtesy RCA

FIG. 11. Internal appearance of a velocity microphone.

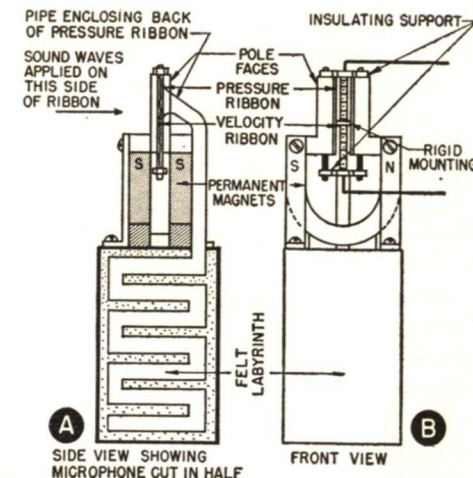

FIG. 12. Front view (A) and side view (B) of the internal appearance of a pressure-operated ribbon microphone.

crimp and straighten out the ribbon so that it sags completely out of position. This calls for a replacement of the ribbon, which can be done only at the factory. When these microphones are moved, they must be carried in a normal operating position—that is, with the ribbon in a vertical plane. Carrying the microphone in a horizontal position makes the ribbon sag or stretch. Jarring or rough handling may cause the ribbon to move far beyond its normal limits, with the result that it may be stretched out of shape or even stick to the magnet. In addition, rough handling may cause the magnet to move. The spacing in this microphone is very small to begin with, so even a slight change in the position of the magnet will restrict the air gap so much that the ribbon cannot move properly in it.

Despite all these difficulties, the velocity microphone is used in some high-quality installations, particularly when music is being picked up, because it offers higher fidelity than does any other kind of microphone commonly used. Should you encounter such a microphone, remember the

above characteristics. Shield it always from wind, and instruct persons speaking into it to stay well away from it and speak "across" the face of the microphone rather than directly into it. Always see to it that a velocity microphone is kept away from alternating current fields such as may be produced by power transformers and by power lines. If anything is the matter with such a microphone, don't open it; it must go back to the factory for repair. Under factory conditions, in air-conditioned, dust-free rooms, it is possible to repair one. However, even taking the screen off to examine such a microphone in an ordinary service shop is quite likely to permit metal particles to get into the air gap and prevent it from working.

For that matter, it is not desirable to try to repair any kind of microphone. If you suspect the microphone of causing trouble, it is far better to try another in its place. If the substitute works properly, then something is the matter with the original microphone and it should be sent back to the factory for repair.

You have now learned basically how all the important types of microphones work, except for the cardioid types, which are combination microphones that we shall discuss a little later. Now let's compare the characteristics of the various microphones to see what makes one type better than the others for different uses.

## FREQUENCY RESPONSE

Practically any kind of microphone will prove satisfactory for voice pickup. However, there is quite a difference in the responses of microphones to music. Furthermore, we can't say that just because a particular microphone happens to be a crystal type or a dynamic type that it necessarily

must have a certain specific fidelity, because it is quite possible to get a better response by careful design of the unit. For example, many of the more common dynamic microphones are reasonably flat over a frequency range of only 100 to 5000 cycles, but high-fidelity types are available that have flat responses from 25 cycles to 12,000 cycles. Other dynamics have responses in between these two extremes.

The same can be said for the crystal microphone, whose response may range from perhaps 100 to 7000 cycles to as much as 30 to 10,000 cycles. Velocity types are practically all high fidelity, with responses from 40 to somewhere between 10,000 and 15,000 cycles, depending on design.

The obsolete carbon types were all low-fidelity units, which is one reason for their disappearance from the p.a. field. The condenser microphone actually offers the widest frequency response of all, but, because of the disadvantages we discussed earlier, it is not used in p.a. Therefore, in general, if the conditions of use would permit either the crystal or dynamic microphone to be used, it is necessary to be sure that the one chosen has a frequency response that is suitable for the fidelity wanted. Naturally, the prices of microphones go up as their fidelity becomes better, because a high-fidelity microphone must be carefully made and uses costly materials. At the same time, high-fidelity microphones are usually more delicate than are low-fidelity units. Hence, it is common practice to choose a microphone that meets the fidelity requirements of the installation but does not exceed them much.

Microphones are like loudspeakers in that their response over a frequency range is not uniform but instead has many peaks and dips. In general, the

dynamic microphone is particularly subject to such variations and the velocity type is least subject to them. However, a well-made, high-quality microphone will have a smoother response than an inexpensive type.

## PICKUP PATTERNS

Microphones do not respond equally to sounds coming from different directions. Some types exhibit definite directional characteristics.

All of the diaphragm types that we have studied are usually made with an enclosure at the rear of the diaphragm. Effectively, therefore, the diaphragm faces only one way in these units. As you might expect, they are much more sensitive to those sounds coming straight toward the front of the diaphragm than they are to sounds coming from other directions.

However, these types are classed

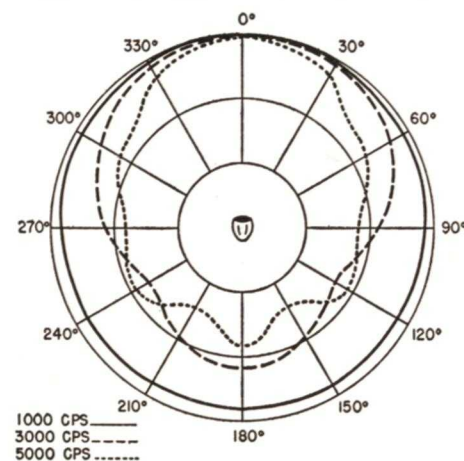

FIG. 13. This graph shows how a nondirectional microphone picks up sound coming from various directions. The response at three different frequencies is shown. The front of the microphone faces the 0° line.

as non-directional microphones because at low frequencies (below 1000 cycles) they do tend to respond to sound waves from all directions. This comes about because at these frequencies the microphone itself is

rather small in comparison to a wavelength, with the result that the diaphragm is operated upon by the pressure of a sound wave regardless of the direction of the wave. At higher frequencies, however, these microphones become at least semi-directional in that they respond better to sound coming from the front (see Fig. 13).

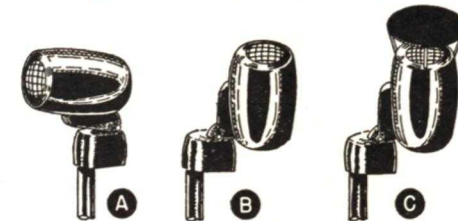

FIG. 14. A microphone that is relatively non-directional in its normal position (A) becomes even more so if it is turned to face upward (B). The response can be further improved by putting a shield above the microphone (C).

If such a microphone is to exhibit good frequency response, then, it must be made to face the source of the sound so that its response will be approximately equal to all frequencies in its normal response range. Hence, the microphone and its stand must be placed so that the microphone faces the source of the sound that is to be picked up.

If sounds from several different directions are wanted, the microphone can be made much more non-directional by pointing it upward. For example, in Fig. 14A, the microphone faces the left, so sounds coming from this direction will be picked up best. The sound pickup will be poorest from the right in this drawing. However, if the microphone is swiveled on its stand so that it faces directly upward (Fig. 14B), it will receive sound best from directly overhead, but will pick up equally from all horizontal directions.

An improvement over this latter arrangement is shown in Fig. 14C. Here a metal shield is placed a short dis-

distance from the opening of the microphone. This prevents sound coming from directly overhead from being picked up much and improves the pickup from the sides.

The ribbon microphones that have their rear sides enclosed in a baffle, which makes them pressure-actuated,

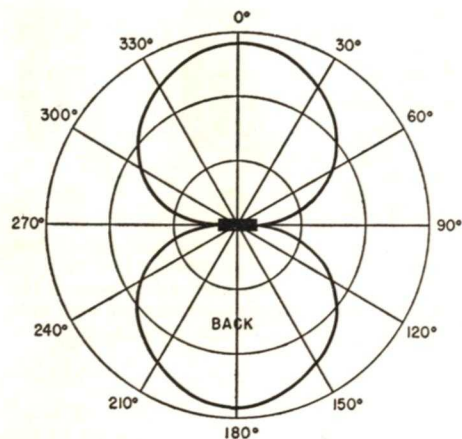

FIG. 15. The response curves of a bidirectional velocity microphone.

example, you want to pick up the music of an orchestra that is playing in a pit in front of a stage. The orchestra will be in two groups, with the conductor in the middle. You can get the desired pickup by placing the microphone in front of the conductor and orienting it so that the two halves of the orchestra are in line with the lines of maximum response of the microphone. This orientation will not only permit the orchestra to be picked up well but will also minimize pickup from the audience, which will be on either the 90° or 270° line of the microphone.

Incidentally, the problem of picking up unwanted sounds such as audience noise, is a severe one in p.a. installations. In fact, very often the possibility of noise pickup determines both the kind of microphone that should be used and the place where it should be located. We shall have more to say about this later in this Lesson.

**Cardioid Responses.** Several microphones have been developed that

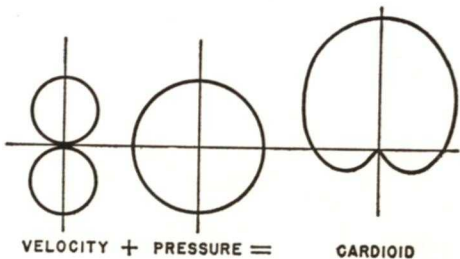

FIG. 16. The cardioid response is produced by combining the responses of a velocity and a pressure unit.

are combinations of pressure-operated and velocity-operated units. These have pickup patterns like that shown in Fig. 16. This pattern is said to have a "cardioid" shape, because it resembles somewhat the shape of a heart.

A microphone having this response

picks up best from in front, less well from the sides, and very little from the rear. It is therefore very useful in applications where there is a single source of unwanted noise: the microphone can be turned so that its rear is toward the noise source, and pickup of the noise will be minimized.

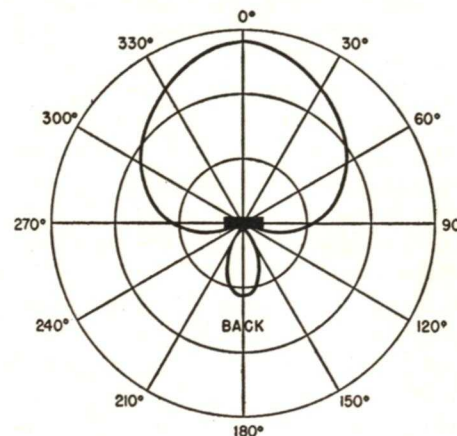

FIG. 17. The response curve of one type of cardioid microphone. Notice the difference between this curve and the true cardioid shown in Fig. 16.

It is also possible to make a microphone having the modified pickup pattern shown in Fig. 17. As you can see, this pattern has two minimums. The microphone will pick up to some extent from the rear but nowhere near as much as from the front. At angles of about 130 and 230 degrees, it has minimum response. A microphone having these characteristics is particularly useful where there are two noise sources.

The cardioid microphone usually contains a ribbon velocity element in combination with something that will act as a pressure device. The kind shown in Fig. 18 has a ribbon element on top and a dynamic unit underneath it. A switch arrangement makes it possible to use the ribbon alone for a bi-directional response, the magnetic unit alone for a non-directional

response, or the two in combination for a cardioid response. The amount of response from the two units can be varied to produce the response shown in Fig. 17, also.

Other combinations are also available, such as a ribbon and crystal unit. A third variety uses only a ribbon that has an air chamber behind half the ribbon and none behind the rest of the ribbon. With this unit, the half with the air chamber acts as a pressure-actuated type and the other half, of course, as the velocity unit.

Still another kind of microphone, known as the Super-Cardioid, has the directional effects of the 2-unit cardioid but contains only a single pressure-actuated unit (either crystal or dynamic). The cardioid effect is

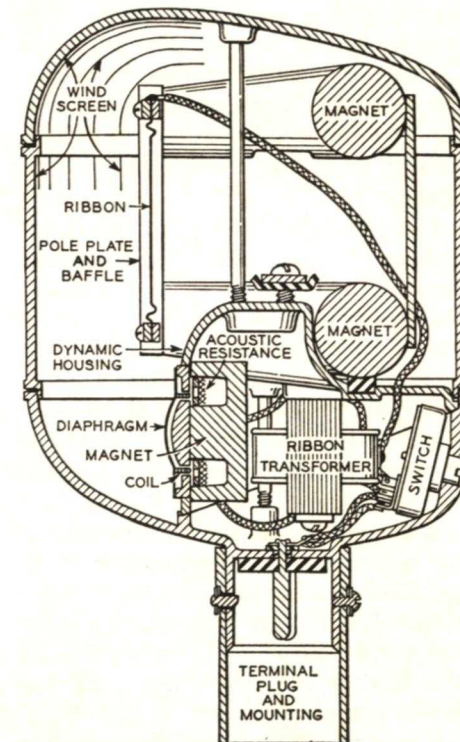

Courtesy Western Electric  
FIG. 18. Cross-sectional view of a microphone that can be used as a nondirectional, bidirectional, or cardioid microphone by turning the switch (lower right) to the proper position.



achieved by incorporating a special acoustic chamber in the microphone housing.

The cardioid reception pattern is obtained from a combination of pressure and velocity units because of the difference in the manner in which the two units respond to sound waves. When the waves come from the front of the microphone, both units are energized simultaneously. Their signal voltages are therefore in phase; and, when they are added in a suitable network, they produce an increased output. When the sound waves come from the back of the microphone, however, the action is not the same. The velocity unit is energized as soon as the waves reach the microphone, but the pressure unit is not energized until the waves reach the front of the microphone a short time later. The output signals of the two units are now out of phase; therefore, they cancel when they are combined, producing a minimum response to waves coming from the rear of the microphone.

Incidentally, the bi-directional response of the velocity microphone does not vary much with frequency: practically the same pattern is obtained for all frequencies to which the microphone responds. Some of this same effect is carried over to the cardioid, although here the pressure-actuated device can cause the pattern to vary somewhat with frequency.

Although it is never a true cardioid, the response of a non-directional microphone can be sharpened so that the response is mostly from the front by the use of an acoustic shield around the face of the microphone. Such a shield plate cuts down on the energy received from any direction except the front. Certain microphones come equipped with such shields; they are usually removable so that non-directional

response can be obtained when it is desired.

### MICROPHONE OUTPUTS

Microphones differ considerably in their output levels, even though all are low and require the use of high-gain amplifiers. The carbon microphone has the greatest output for a fixed sound level; the condenser microphone and its built-in amplifier have nearly as much; the crystal microphone has the next greatest output; and the dynamic microphone output ranges from about the level of the crystal microphone down to that of the velocity, which has the least power output.

Naturally, if you are to drive an amplifier to full output, the microphone you use with it must supply at least the minimum input power for which the amplifier was designed. As a practical matter, it is best to use the kind of microphone recommended by the manufacturer of the amplifier, if he makes any recommendation. If the amplifier manufacturer does not recommend a specific microphone, you must choose one that has a suitable output. If low-impedance dynamic and velocity microphones can be used with a particular amplifier, any other kind can also be used with it, because all other kinds have higher outputs.

Microphone sensitivity ratings are often confusing, because at least six different reference levels are in use. Most manufacturers rate their microphones in terms of the electrical output across a properly matched load at a reference frequency, with respect to a particular reference sound pressure. A few rate microphones unloaded, however; doing so gives an output that is 6 db more than it will actually be when the microphone is properly matched. (The unloaded voltage is higher because, when the

microphone is properly loaded by an impedance equal to its own impedance, half the source voltage is dropped across the microphone impedance.)

Microphones are usually rated in terms of decibels down from either a reference voltage or a reference power, with the reference sound pressure given in dynes per square centimeter. (Sometimes the pressure is stated in bars; a bar is equal to one dyne per square centimeter.)

The reference voltage is usually 1 volt, but the reference power may either be 1 milliwatt or 6 milliwatts. Table 1 gives the six most commonly used reference levels. As a typical example, you may find the rating of a

1 volt/1 dyne/cm <sup>2</sup>
1 volt/10 dynes/cm <sup>2</sup>
1 volt/100 dynes/cm <sup>2</sup>
.001 watt/1 dyne/cm <sup>2</sup>
.001 watt/10 dynes/cm <sup>2</sup>
.006 watt/10 dynes/cm <sup>2</sup>

microphone given as “—50 db below 1 volt/1 dyne/cm<sup>2</sup> into a load of 1 megohm.” When the complete rating is given this way, you know at least what reference level was used. On the other hand, if the listing is just “—50 db,” as it frequently is in supply-house catalogs, you won’t know what reference level was used; and you may be badly misled if you compare the output level of this particular microphone with that of another that was rated on the basis of a different reference.

For example, three different pressure reference levels are given in Table 1, each 10 times the pressure of the one preceding. A 10-times difference in pressure on a microphone increases its output by 20 db. Therefore, the same microphone could be rated at —70 db below 1 volt/1 dyne/

cm<sup>2</sup>, or —50 db below 1 volt/10 dynes/cm<sup>2</sup>, or —30 db below 1 volt/100 dynes/cm<sup>2</sup>.

Similarly, a power rating in terms of 1 milliwatt is 8 db higher than it would be if the microphone were rated on the basis of a 6-milliwatt reference level. In other words, a microphone rated at —50 db for the 1-milliwatt level would have to be rated at —58 db if the 6-milliwatt level were used as the reference.

All this means that we have to be careful to choose a microphone whose db output level is high enough to give full rated output from the amplifier used. Then, when we compare microphones made by different manufacturers, we must be careful always to make sure that their ratings are in terms of the same reference; otherwise, we may get the wrong idea of their relative outputs. If you cannot tell what rating standard was used from the information given, write both the manufacturer of the microphone and the manufacturer of the amplifier. One or the other will be able to tell you whether the particular microphone and amplifier you are interested in will work properly together.

Of course, once you have had experience with particular brands of microphones, you won’t have to worry about the reference standards used, because you will know what their ratings are.

### MICROPHONE IMPEDANCES

In general, microphones are classed as either low impedance or high impedance. The ribbon microphone has a very low impedance, and it nearly always has a built-in transformer that is designed to match the microphone either to a 500-ohm audio line or directly to the grid of an amplifier tube. Dynamic microphones have imped-

ances ranging from around 8 ohms up to about 50 ohms. Sometimes built-in transformers won't be provided with those around 50 ohms, but the ones commonly used in p.a. work all have transformers designed to match them to 500 ohms or to a high-impedance input.

The only other common type—the crystal microphone—is usually a high-impedance microphone.

Amplifier inputs are generally designed either for high-impedance microphones or for 500-ohm transmission lines. One designed for a high-impedance microphone can be used with either a crystal microphone or a magnetic or velocity microphone that has an appropriate matching transformer.

When high-impedance inputs are used, the cable from the microphone to the amplifier cannot be very long. One reason is that there will be considerable frequency attenuation, as we shall learn elsewhere. Another reason is that if any point in the circuit is at a high impedance with respect to ground, very small stray hum and noise fields will introduce fairly large disturbing voltages. And, of course, the longer the section of the circuit above ground, the more likely there is to be trouble. It is therefore necessary to keep the microphone cable as short as possible—lengths are usually held to 10 to 25 feet at the most.

If the amplifier has a 500-ohm input, on the other hand, it is possible to use a 500-ohm transmission line,

which permits cable lengths to be as much as 1000 feet. When a 500-ohm line is used, it is of course necessary that the microphone have a transformer designed to match it to the line and that the line be matched to the grid of the input tube of the amplifier by another transformer.

As a general rule, therefore, we can say that if the microphone is to be used within 10 to 25 feet of the amplifier, we can use a high-impedance microphone that is connected directly to the amplifier. This may be either a crystal microphone or a dynamic or velocity microphone containing a transformer that matches its impedance to that of the amplifier input circuit. A dynamic or velocity microphone that is matched to 500 ohms by its built-in transformer can also be used if it is connected to the 500-ohm input of the amplifier or if it is connected to another transformer that will match 500 ohms to the high-impedance input of the amplifier.

On the other hand, if the microphone is to be used at a greater distance from the amplifier, we must either use a low-impedance type matched to a 500-ohm line, which in turn is matched to the amplifier, or we must feed from a high-impedance microphone into a preamplifier that is a separate unit from the main amplifier. Then, this preamplifier can be connected to the main amplifier at a distance by proper matching through a 500-ohm line, as we will show later.

## Loudspeakers and Their Enclosures

You have studied loudspeakers elsewhere in your Course, so we shall not have to spend time here to describe their operation. Instead, we shall discuss their use in p.a. work.

A few magnetic loudspeakers are used in p.a. installations, but dynamics are by far the most common. Permanent-magnet dynamics are almost always the kind chosen, because they do not require a field supply. Since the loudspeakers must frequently be mounted at a great distance from the amplifier, it would be impractical to furnish a field supply from the amplifier, because the extra pair of leads in the cable would greatly increase the cost and complicate the installation. Therefore, if an electrodynamic loudspeaker were to be used in such cases, it would have to have its own built-in field supply, which would have to be connected to a source of power. This would greatly increase the expense and would probably cause a higher hum level.

Therefore, the electrodynamic loudspeaker is commonly used only in small portable p.a. systems in which the loudspeaker is built into the amplifier assembly or is connected to it by a rather short cable.

The voice coil impedances of the loudspeakers used in p.a. work are similar to those of the loudspeakers used in home radio receivers: 4 ohms, 8 ohms, and 16 ohms are the most common.

Two basic loudspeaker types are used in p.a. installations. One is the familiar kind in which the voice coil drives a paper cone; in the other, the voice coil drives a metal diaphragm.

The paper-cone type is usually found in the lower-powered indoor installations and in high-fidelity in-

stallations in which large amounts of low-frequency power must be handled. In the latter case, cone-type loudspeakers are used because of the nature of the baffle enclosures that must be used to give the desired fidelity.

The cone-type loudspeaker has two major disadvantages. One is that it is remarkably inefficient. Even when it is placed in a proper baffle enclosure, it is usually considered to be no more than 2% efficient. This means that only 2% of the audio power fed to the loudspeaker is actually converted into sound power. Fortunately, the human ear responds remarkably well to very small amounts of sound power, or cone loudspeakers would be completely impractical.

Another disadvantage of the cone loudspeaker is the fact that the paper cone will deteriorate with age, particularly if it is subjected to conditions of high humidity. Naturally, such a paper cone could not be used

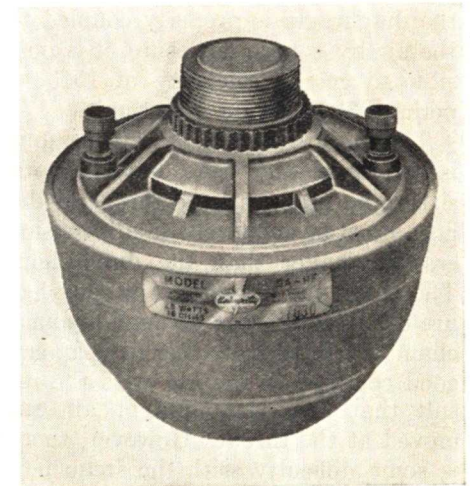

Courtesy University Loudspeakers, Inc.

This is a typical driver unit used with horn loudspeakers.

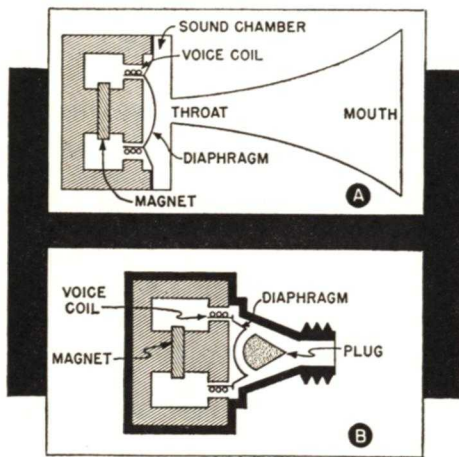

FIG. 19. An early form of horn loudspeaker equipped with a driver unit is shown in A. In the modern form, shown in B, reflections within the sound chamber are eliminated by adding a plug in the throat and by shaping the diaphragm to match the end of the plug.

outdoors without ample protection against weather.

These disadvantages of cone loudspeakers have led to the development of high-powered driver-type units that have metal diaphragms instead of paper cones. Such driver units are invariably used with horn enclosures, which we shall describe shortly. When the diaphragm is properly coupled to the air by a horn enclosure, it is possible to get an efficiency of 15% to perhaps 30% from a driver unit.

The basic structure of a driver unit is shown in Fig. 19A. For the horn size to be practical, the throat of the horn must be relatively small, considerably smaller than the diaphragm. Therefore, the diaphragm in this figure drives the throat through a sound chamber. Effectively this gives a very good coupling to the air, with the result that large amounts of air are moved at the throat. However, there is some difficulty with the frequency response, because, particularly at high frequencies, there are reflections within the sound chamber.

Fig. 19B shows one way this problem can be solved. As you can see, the diaphragm has a ball-shaped indent in it, and there is a plug in the center of the sound chamber whose rear edge is shaped like the indent in the diaphragm. The motion of the diaphragm forces air to flow around the plug and thence through the throat into the horn. This arrangement makes it practically impossible for any sound waves to be reflected from the walls of the sound chamber back to the diaphragm; instead, any reflected waves are channeled toward the throat by the sloping sides of the plug and the chamber. Many variations of this plug system have been worked out, but they all work on similar principles.

### LOUDSPEAKER Baffles

A cone loudspeaker unit must be enclosed in some form of baffle to produce a reasonable coupling to the air. The shape and size of this baffle in a radio receiver depend on the fidelity and the efficiency desired. The same factors enter into p.a. work, and in addition, we have to worry about the possibility that sound from the

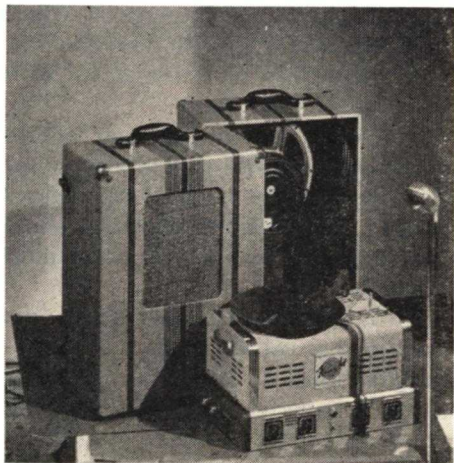

Courtesy Allied Radio Corp.  
FIG. 20. These are box baffles of the sort commonly used in portable p.a. systems.

loudspeaker may travel through the air to the microphone. If sufficient energy can get from the loudspeaker back to the microphone, the system can become a self-sustaining oscillator, because this fed-back sound can replace the original sound and continue to repeat itself over and over through the microphone-amplifier-loudspeaker-air-microphone path. For this reason, loudspeaker baffles for p.a. work commonly have closed backs; this makes it possible to operate the loudspeaker near the microphone location without fear that the sound coming from the back surface of the loudspeaker cone will reach the microphone directly. An open baffle can be used only when the loudspeakers are located in such positions that feedback is unlikely.

Let's see what various common baffles are like.

### CONE-LOUDSPEAKER Baffles

The simplest enclosure for a cone loudspeaker is the box baffle shown in Fig. 20. Two such box baffles are commonly used in portable p.a. systems, the two being so constructed that they can be secured together to

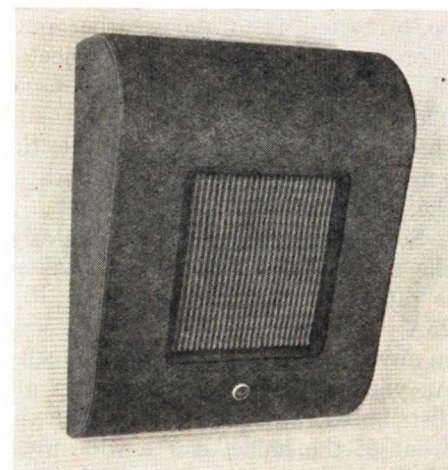

Courtesy RCA  
FIG. 21. A typical wall baffle.

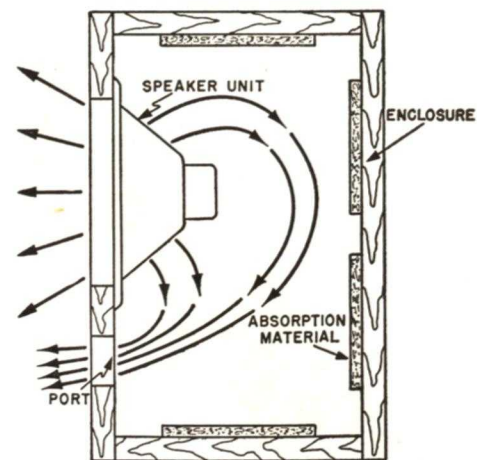

FIG. 22. Cross-sectional view of a bass reflex baffle. The arrows show the directions of the sound waves from the front and the back surfaces of the loudspeaker cones.

form a closed box in which there is room for the amplifier when it is desired to carry the whole system from one place to another.

A baffle of this sort is not sufficient to give high fidelity, but it is adequate for voice or popular music. Since the back of this baffle is completely open, it must be carefully located with respect to the microphone to prevent feedback from the loudspeaker to the microphone.

Another simple baffle is shown in Fig. 21. This is a box that is intended to be hung on a wall. If enclosures of this sort are properly scattered around, well away from the microphone, it is possible to keep the feedback down to a satisfactory level. This baffle is actually enclosed at the back when it is mounted firmly against the wall, but since it is mounted so that it faces into the room, it can feed sound into the microphone unless the latter is carefully placed.

The larger cabinet baffles that are used where better tone quality is desired are generally completely enclosed at the rear. In most instances,

such units are of the bass reflex type, an example of which is shown in Fig. 22.

Any of the baffles described so far gives a relatively broad sound distribution somewhat like that obtained from a radio receiver. There are occasions, however, when it is desired to project sound in a more compact "bundle" to a distance, or when it is

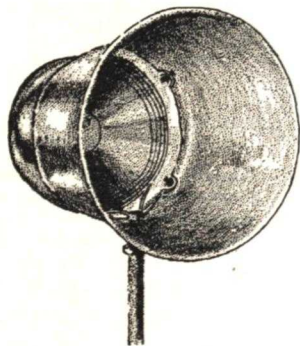

FIG. 23. A cone loudspeaker mounted in a projector housing.

necessary to prevent sound from going in certain directions to eliminate feedback. With cone loudspeakers, projectors (sometimes called trumpets) are used for such occasions. An indoor type is shown in Fig. 23. Basically, this is a directional enclosure,

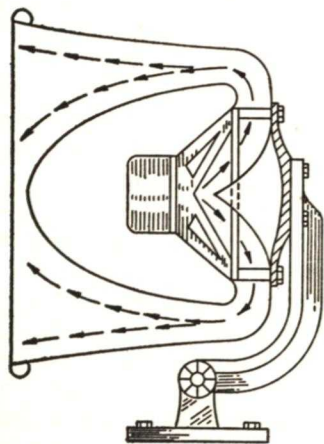

FIG. 24. A cross-sectional view of a cone loudspeaker mounted in a weatherproof projector. Such an assembly can be used outdoors.

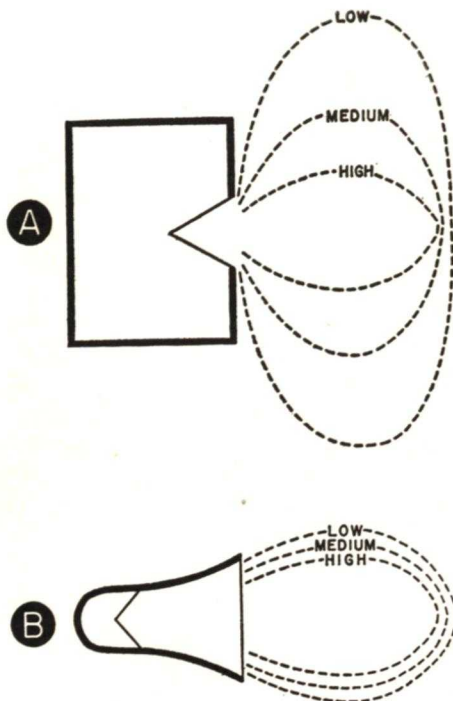

FIG. 25. This shows how a cone loudspeaker mounted in a box baffle (A) and one mounted in a projector horn (B) differ in their sound distribution characteristics.

very similar to a horn in its directive effects.

Outdoors, a variation of the projector is the only kind that is practicable with cone loudspeakers. Cones must be protected from the weather outdoors, so a weather-proof projector like the one shown in Fig. 24 is used. This is so designed that rain and spray will not seriously affect the cone even if they enter the mouth of the projector directly.

**Sound Distribution.** Incidentally, the sound output from loudspeakers is rather peculiarly distributed. Fig. 25A shows the result of using a cone in any standard wall or cabinet baffle. As you can see, low frequencies are distributed rather uniformly from the front of the baffle over a wide area. Medium and high frequencies become more and more directional, however;

the sound distribution at the highest frequencies is practically a narrow beam straight in front of the cone. This unequal sound distribution presents quite a problem if we are interested in high-fidelity sound distribution. It is obvious that only the

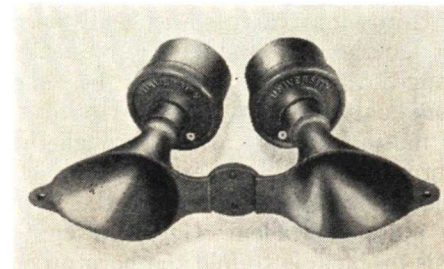

Courtesy University Loudspeakers, Inc.

FIG. 26. A double loudspeaker designed to give wide-angle distribution of high-frequency sounds.

people who are directly in front of the cone will get all the frequencies with equal intensity.

The projector distribution shown in Fig. 25B is much more nearly uniform. However, here we run into the fact that the projector isn't a very good baffle, because its low-frequency response is poor for reasonable pro-

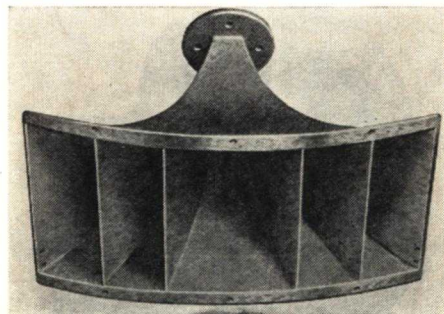

Courtesy Jensen Mfg. Co.

FIG. 27. A cellular high-frequency horn.

jector sizes. In other words, a projector gives more uniform sound distribution with frequency than a box baffle does, but the box baffle gives better fidelity.

To improve sound distribution,

high-fidelity installations frequently use dual loudspeakers. In such installations, a large cone loudspeaker is used to give low-frequency coverage; the high frequencies are handled by a small loudspeaker unit (usually a driver type) that is designed to give an angle of coverage that approximates the medium-frequency coverage of the large cone. Fig. 26 shows one type of high-frequency loudspeaker, which consists of a pair of driver units arranged with dual horns at such an angle that a rather wide coverage is obtained. Fig. 27 shows a "cellular" construction in which the

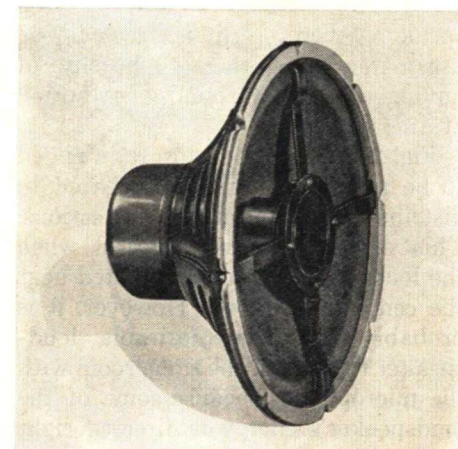

Courtesy Jensen Mfg. Co.

FIG. 28. A typical coaxial loudspeaker.

horn is broken into segments that disperse the sound to give a wide angle of coverage. This horn is driven by a single driver unit.

A form of dual loudspeaker that is commonly used in high-fidelity installations is shown in Fig. 28. This unit, called a coaxial loudspeaker, is used chiefly because it has a wide frequency range. In the immediate vicinity of such a loudspeaker, the fidelity is quite good, but it does not offer particularly wide-angle high-frequency coverage. Where a large area is to be covered with such loud-

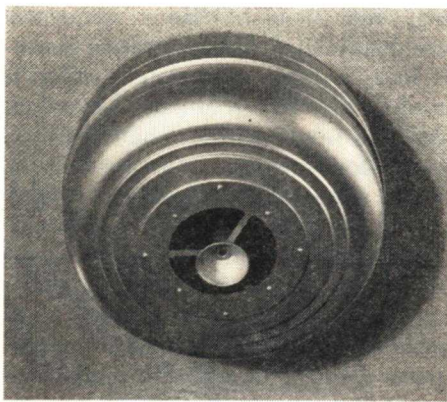

Courtesy Langevin

FIG. 29. A loudspeaker in a housing designed for ceiling mounting. The small horn at the bottom helps diffuse the sound.

speakers, therefore, it is necessary to use a number of them to be sure of having reasonable sound distribution at all frequencies.

Fig. 29 shows an enclosure intended to be mounted in the ceiling and to distribute sound in all directions. This enclosure is very useful when the loudspeaker is to be mounted near the center of a room. However, it is probably the least desirable loudspeaker to have in the same room with the microphone, because some of the loudspeaker's energy is directed right at the microphone.

### HORN ENCLOSURES

Some form of horn or trumpet enclosure is invariably used with driver units. Both the fidelity and the coverage angle are largely determined by the kind of enclosure chosen. A long, narrow horn with a small mouth tends to project sound directly in front of the mouth of the horn without allowing it to spread very much. On the other hand, if the horn flares outward rapidly, sound is distributed over a much wider angle.

From a fidelity standpoint, the rate of increase of the cross-sectional area of the horn is particularly important.

In general, the horn must be rather long to have good low-frequency response. Since it should increase regularly in cross-sectional area as it increases in length, we must start with a very small throat if we are to have a reasonable mouth size in any practical horn length.

Horns that carry speech only need to handle only a limited frequency range; therefore, they can be, and commonly are, rather short. However, if music is to be carried through the horn, it must be long—so long, in fact, that the space required by the horn is quite a problem. One solution to this problem is to fold the horn up on itself as shown in Fig. 30. Even folded in this manner, the horn is rather large; a horn of this sort is generally used only in large auditoriums or theaters.

A more commonly used arrangement for getting a relatively long horn length in a small space is shown in Figs. 31 and 32. This device is known as the re-entrant or reflex horn. The name comes from the fact that the sound travels down an inside horn,

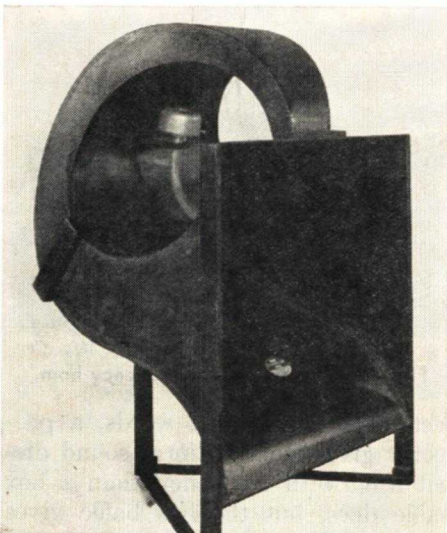

FIG. 30. A folded horn of the sort used in theaters and large auditoriums.



Courtesy University Loudspeakers, Inc.

FIG. 31. A typical reflex trumpet, much used for outdoor installations.

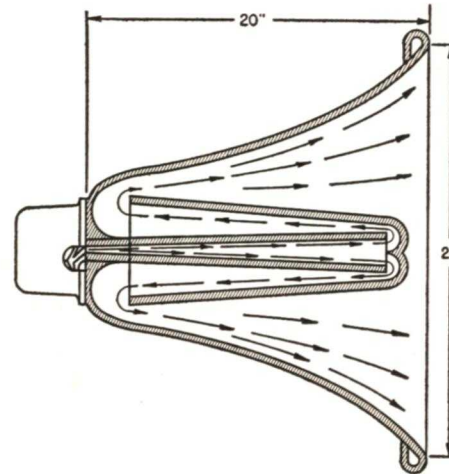

FIG. 32. Cross-sectional view of a reflex trumpet.

then is forced back toward the rear before it finally comes out of the mouth of the horn, as shown in Fig. 32. Because of this internal folding, it is possible to make the over-all dimensions of the horn rather short and yet have a fairly long air column. Furthermore, such a horn is weather-

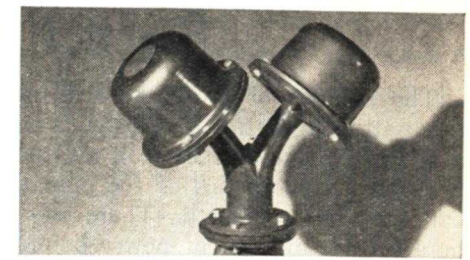

FIG. 33. A coupling of this sort makes it possible to use 2 driver units with one horn.



Courtesy University Loudspeakers, Inc.

This is an extremely powerful loudspeaker in which 12 driver units are used. It can handle powers up to 300 watts and can be heard for several miles.

proof, making it ideal for outdoor use.

Most drivers designed for use with horn units are rated at 25 watts but will work efficiently on 8 to 10 watts. If greater power is needed, extra loudspeakers may be used, or more than one driver may be used with a single horn. Fig. 33 shows a two-unit type; as many as twelve drivers are used on super-powered horns.

Now that you have a general idea of what the pickup patterns of microphones and the sound distribution patterns of loudspeakers are like, let's take up the practical problems of determining how much power is necessary for an installation.

# Practical Acoustics

The amount of power needed for any particular installation depends on a number of factors. First of all, the hearing characteristics of the human ear must be considered. There must be a certain amount of power before the human ear registers any sound at all, the exact amount depending on the frequency of the source. At this threshold level, the ear is not at all a high-fidelity device; therefore, considerably more than this minimum power is needed to permit an audience to hear comfortably and with reasonably good fidelity.

As we have pointed out before, the noise level at the location of the installation must also be taken into account in determining the amount of power needed; the greater the noise, the greater the power that will be necessary. Indoors, we also have the problem of sound reflection from the walls and ceilings. Sound reflection is seldom a problem in an outdoor installation, but sound dispersal is. Let's make a complete study of each of these factors in turn to see how they affect the amount of power needed.

## HEARING CURVES

The ear is very peculiar in the manner in which it responds to sound levels at different frequencies. It is most sensitive to sounds at about 2000 cycles. In other words, a very low-power sound at this frequency will be audible. At low or high frequencies, however, far more power is necessary to make a sound audible.

Fig. 34 contains a series of curves that indicate the average hearing ability of the human ear. Sounds having the intensities shown by curve A can just barely be heard, and sounds having lower intensities can-

not be heard at all: curve A is therefore called the "threshold of hearing." Notice that this curve is very non-linear, illustrating what we just said about the ear being most sensitive at the minimum-loudness level to sounds around 2000 cycles and least sensitive to low-frequency and high-frequency sounds.

This variation in sensitivity with frequency becomes less marked at higher loudness levels. The dashed curves above curve A show the response of the ear at various loudness levels 10 db apart. (The threshold of hearing is used as the zero db reference.) As you can see, the response becomes much flatter as the loudness increases.

If a sound is made loud enough, the ear will feel pain instead of hearing

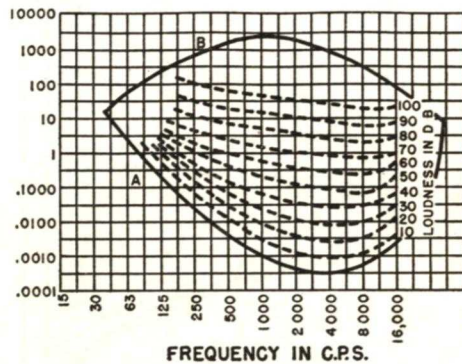

FIG. 34. The frequency-response curves of the human ear for sounds of various levels. Curve A shows the threshold of hearing, curve B the threshold of pain.

the sound. The loudness level at which pain is felt (which is called the "threshold of pain") is represented roughly by curve B in Fig. 34. Notice that this curve intersects the threshold of hearing at very low and very high frequencies but is widely separated from it at the middle frequencies. At frequencies around 1000 to 2000

cycles, the change is roughly about 120 to 130 decibels from the threshold of hearing to the threshold of pain.

You can see from these facts that the average person is able to hear only the middle frequency range if the sound level is very low; the low and high frequencies are completely inaudible. As the sound level is increased, higher and lower frequencies can be heard.

Obviously, the sound output of a p.a. system should be at least great enough to permit all the frequencies we are interested in to be heard comfortably. This means that the power required for a particular installation depends on what the system is intended to carry. If it is to be used for instrumental music, a wider frequency range must be handled than is needed if only voice frequencies are to be carried; consequently, more power is needed for the former kind of installation.

For convenience in comparing sound levels, it is standard practice to choose a reference frequency in the range where the hearing is most acute. The level necessary to produce an audible sound at this reference frequency is then considered to be the threshold of hearing, and other sounds and noises are said to be a certain number of decibels above this threshold level.

## EFFECT OF NOISE

The ability to hear any sound is considerably affected by the noise level. Theoretically, even the weakest of the sounds in which we are interested should be at a level above the surrounding noise level if it is to be heard easily. Therefore, we need to know the noise level before we can choose the p.a. system.

Fig. 35 shows the sound levels of various common noises, and the noise levels that are found in typical places

Type of Sound Source	DB Level
Threshold of painful sound	130
Hammer blows on steel	120
Riveting machine	100
Factory (very noisy)	90
Machine Shop (average)	90
Heavy street traffic	85
Printing Press	80
Ball Rooms	80
Restaurant (noisy)	80
Factory (average)	75
R.R. waiting room	75
Auditorium (average)	75
Office (busy)	65
Department store (average)	65
Auditorium (quiet)	65
Ordinary conversation	60
Quiet residential street	60
Restaurant (average)	60
Store (quiet)	60
Office (quiet)	60
Hotel lobby	55
Hospitals	55
Average quiet residence	35
Quiet garden	25
Average whisper	20
Rustle of leaves in gentle breeze	10
Threshold of hearing	0

FIG. 35. These are the levels in db above the threshold of hearing of various common sounds and noises. The figures have been compiled from several sources.

where p.a. systems may be used. Notice that the noise level in the average quiet home is about 35 db above the threshold; since the average conversation level is higher than this, we, of course, need no amplification to overcome the noise in a home. As a matter of fact, p.a. amplifiers are not needed to overcome noise until the noise level is above that of the desired sound. Acoustics standards state that the *average* sound level for *speech* should be maintained at least 10 db above the surrounding noise level. This is not practical, of course, when the noise level is up near the threshold of pain, because the sound level might then be over the threshold for some frequencies. It is therefore frequently impossible to keep the sound level above the surrounding

noise level to any great degree in installations in very noisy factories.

For ordinary music, it is desirable to have the *average* sound level 15 db higher than for voice, or a total of 25 db above the noise. High-fidelity reproduction of symphonic music re-

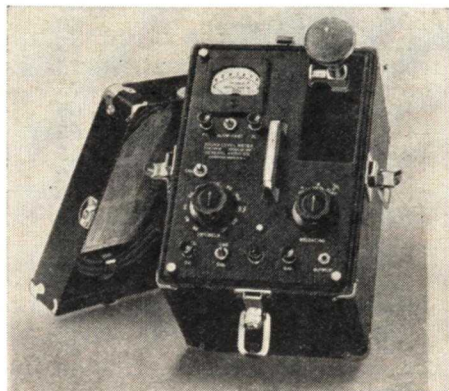

Courtesy General Radio Co.

A sound-level meter of this sort is very useful for determining the noise level at the site of an installation.

quires another 10 db above ordinary music, or an *average* level 35 db above the noise level. Of course, there will be peaks that exist above the average levels; however, proper design on an average power basis permits the peak power capabilities of the amplifier to handle these.

One of the problems always facing the sound engineer, therefore, is the determination of the noise level at the location where a p.a. system is to be installed. This determination must, of course, be made under the conditions that will be present at the time the p.a. system is to be used. An empty auditorium is far quieter than one filled with people. This is particularly true at a sporting arena, where an enthusiastic crowd of spectators can make the noise level very high.

To determine the noise level, one must guess at it (a very difficult thing

to do accurately), measure it with a noise level meter, or depend upon practical tables or charts like Fig. 35. Loudspeaker manufacturers give average levels in charts designed around their particular loudspeakers. We'll say more about this later.

## SOUND REFLECTIONS

As we have already said, sound reflections from the walls, floors, and ceilings of a room are a major problem in indoor p.a. installations. These reflections provide additional paths over which sound waves travel from the source to the listener. Fig. 36 gives a simple example.

Such reflections occur because whenever sound waves strike a surface, some of the energy is absorbed and lost, some is transmitted through the material, and the remainder is re-

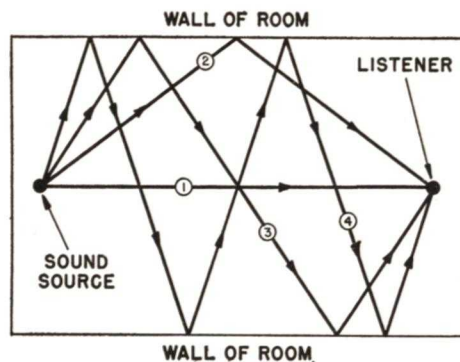

FIG. 36. The direct sound wave between the source and the listener travels over path 1, which is the shortest path between these two points. Waves traveling over paths 2, 3, or 4 must go a greater distance to reach the listener, and consequently arrive somewhat later than those taking path 1.

flected much as light rays are reflected by a mirror. How much reflection there is depends on the material; hard, smooth materials like plaster reflect far more than do soft materials like drapes. These reflections "save" energy by preventing it from escap-

ing from the room. However, the re-

## REVERBERATION

turn of this sound energy is not instantaneous; it takes more time for sound to travel over a longer path, so sound waves that reflect from wall to wall do not arrive at a given point in step with sound waves coming over a more direct path. Such reflected waves may cause the sound at any particular spot to be louder, softer, or unintelligible. Let's study this last effect first.

When the surfaces of a room are hard and smooth, reflections occur and recur, with the result that it takes time for sounds to die out. Consequently, syllables or words traveling over direct paths are interfered with by earlier sounds traveling over the reflection paths. This prolongation of sounds, which is called reverberation, is the most common acoustic problem in auditoriums.

Unless a room is made absolutely dead by special acoustic treatment (by making the surfaces absorb energy instead of reflecting it), there will always be a certain amount of this reverberation. The actual amount depends on the size and shape of the room and on the characteristics of the materials used in the room. We don't want a room to have no reverberation—such a room sounds "dead," and music or speech is flat in it. A certain amount of reverberation makes a room "alive"; music, in particular, has more brilliance and richness of tone in such a room.

To determine what treatment may be necessary to make a room more nearly ideal in this respect, engineers assume that the *period* of reverberation is the time it takes for a sound to decrease in energy by 60 decibels. To measure this period, a short, sharp

sound is made, and timing devices are used to determine when it has decreased by this amount. If the time taken is reasonable for the size of the room, no treatment is necessary. In general, the larger the room, the longer the reverberation period that can be permitted. There is no exact agreement on the amount of time that is permissible, however, because this depends upon whether it is speech or music that is to be reproduced and upon what the installer thinks is an ideal "liveness" for the room. Usually periods of under two seconds are necessary. "Ideal" periods for music in rooms of various sizes are shown

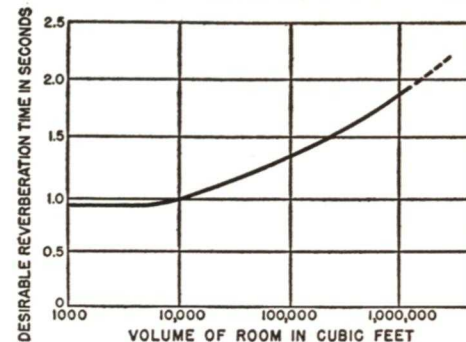

FIG. 37. This graph shows the desirable reverberation time for rooms of various sizes in which music is to be played.

in Fig. 37. For speech, the ideal is from half to two-thirds the values given in this figure.

As an example of how excessive reverberation affects the ability to understand speech, a reverberation period of 5 seconds in a 5000-cubic foot auditorium reduces the number of recognizable syllables to only about 60% of the total. At least 75% recognition is necessary for intelligibility with very careful listening, and about 90% is needed for high-quality reproduction. In a room of 5000 cubic feet, a reverberation period of about .6 second is required for 90% intelligibility.

## ACOUSTIC TREATMENT

Since the reverberation time is related to the volume of the room in cubic feet and to the absorbing ability of the surfaces of the room, there is a formula that can be used for calculating the approximate reverberation period of a room. It is:

$$t = \frac{.05V}{a}$$

where "V" is the volume of the room in cubic feet, "t" is the period in seconds, and "a" is the number of absorption units of the materials used.

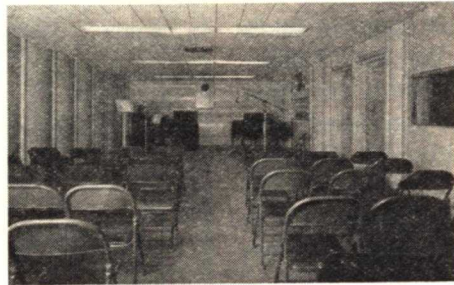

*Courtesy The Celotex Corp.*

A small broadcast studio that has been acoustically treated with Acousti-Celotex tile on the ceiling and carpeting on the floor. The walls have been irregularly shaped to improve sound diffusion. Acoustical treatments in rooms served by p.a. systems are similar, though seldom so extensive.

We shall discuss absorption units in a moment.

This formula makes it possible to calculate the approximate period for a room. If the period is wrong, we can determine how much the absorption has to be changed to make the reverberation proper by restating the formula as:

$$a = \frac{.05V}{t}$$

which gives us the number of absorption units needed for a room of volume V to have the desired reverberation period t.

In general, acoustic treatment of a room is best left to an acoustical

engineer. In a large auditorium, proper acoustic treatment involves a considerable expense, so it is far better to have the room treated by someone familiar with the materials that can be used for the purpose. If you have such a problem, therefore, you should call in an engineer or a representative of a company manufacturing sound-absorbing material. However, so you will understand what must be done, let's see how such an expert would go about planning the acoustic treatment of a room.

The number of absorption units in a room is computed by multiplying the area in square feet of each surface by a factor (called the absorption coefficient) that indicates the absorbing power of each square foot of the material. The total number of absorption units in the room is the sum of these, plus the units furnished by the audience and by the furniture.

As a general rule, any hard, smooth surface has very little absorption, so materials such as plaster walls will reflect sound and keep the reverberation period high. The same can be said for hard floor materials and for wooden seats.

On the other hand, soft, coarse ma-

terials absorb sound, so the period of reverberation can be reduced by the use of drapes or other cloth hangings, upholstering or pillows on the seats, rugs on the floor, etc. Even better sound absorption can be obtained through the use of special acoustic materials, which are commonly made of cane fibers. These materials either have a rough surface or have a surface with many small holes in it that break up the sound reflection and absorb much of the energy of the sound wave. Covering plaster ceilings and walls with such materials cuts down greatly on the reverberation and also reduces the noise (since it, too, is absorbed).

Materials	Coefficients
<b>Floor Coverings:</b>	
Carpet	.20
Cork flooring	.08
Linoleum	.03
Rug, Axminster	.20
Wood flooring	.03
<b>Hangings:</b>	
<b>Fabrics:</b>	
Light	.11
Medium	.13
Heavy	.50
<b>Hard Wall:</b>	
Brick, painted	.017
Cement	.025
Plaster on lath	.03
<b>Openings:</b>	
Window	.5—1
Balcony	.5—1
<b>Audience and Chairs:</b>	
People	3—4.3
Chairs, wooden	.17
Chairs, upholstered	1.6
<b>Acoustic Materials:</b>	
Acousti-Celotex C-2	.67
Acousti-Celotex C-4	.99
Acoustone F	.87
Fiberglas Tile (1")	.97
Permacoustic (1")	.71

FIG. 38. The absorption coefficients of various materials. The figures given for audience and chairs are in terms of absorption units per person or per chair; the other figures are for absorption units per square foot. These units were determined at 512 cycles. The absorption at other frequencies differs somewhat, usually, though not always, increasing at higher frequencies.

Wood floor:	(100 x 20 = 2000) x .03 = 60
Plaster walls:	(240 x 10 = 2400) x .03 = 72
Plaster ceiling:	(100 x 20 = 2000) x .03 = 60
Wood Chairs:	50 x .17 = 8.5
	200.5
Volume = 100 x 20 x 10 =	20,000 cu. ft.
.05 x 20,000	
t = $\frac{200}{200}$	= 5 sec.

FIG. 39. The computations needed to determine the reverberation period of the room described in the text before it is acoustically treated.

The presence of an audience may change the characteristics of a room considerably. Clothing is very efficient as an absorption material.

Fig. 38 gives a general idea of the absorption coefficients of several typical materials. (The figures given for people, wooden chairs, and for upholstered chairs are absorption units per person or per chair, not absorption coefficients.)

To take a practical example, let's suppose we have a small hall 100 feet by 20 feet by 10 feet high, which has a volume of  $100 \times 20 \times 10 = 20,000$  cubic feet. Let's suppose it has a wood floor and plaster walls and ceilings. Let's also suppose there are about fifty wooden chairs in the hall.

Fig. 39 shows the details of calculating the absorption units present in the basic hall, using the average coefficients given in Fig. 38. There are 2000 square feet of floor space, and wood flooring has an absorption coefficient of .03, so the floor has a total of 60 units. A plaster wall around the room has a total area of 2400 square feet; its absorption coefficient is also .03, making its absorption 72 units. The ceiling has a total



of 60 units and the chairs a total of 8.5 units. The sum of all these is 200.5, which we can round off to be 200 units.

The volume of the room is 20,000 cubic feet, so the time, as shown by the calculations, is five seconds. This is too long; Fig. 37 shows that it should be about 1.1 seconds for a room of this size if music is to be played in it.

An audience of fifty people present in the chairs will change matters, because the audience has an absorption of about four units per person or a total absorption of 200 units, which

Carpet:	(100 x 20 = 2000) x .2 = 400
Med. drapes on walls:	2400 x .13 = 312
Plaster ceiling:	2000 x .03 = 60
Upholstered chairs:	50 x 1.6 = 80
	852
	$t = \frac{.05 \times 20,000}{852} = 1.17 \text{ sec.}$

FIG. 40. How acoustical treatment affects the reverberation period of the room.

cuts the time in half, or to 2.5 seconds. Therefore, this hall will have much better characteristics with an audience than it has when empty. Even so, it still has too long a period. Using the formula for determining the absorption units needed, we find that to produce a 1.1-second period, we need:

$$a = \frac{.05 \times 20,000}{1.1} = 910 \text{ units}$$

(approximately) instead of the 200 to 400 we have.

Covering the floor with carpet, hanging medium-weight drapes on the walls, and using upholstered chairs produces the effects shown by the calculations in Fig. 40—the reverbera-

tion period is changed considerably. Our time of 1.17 seconds is now much better for a room of this size. With an audience adding 200 more units, the time is reduced to about one second, so this treatment is just about right.

Of course, a treatment that involves hanging drapes completely around the room, installing a carpet over the whole floor, and changing from wooden chairs to upholstered chairs cannot be described as a simple one. It may be less costly and more satisfactory in the long run to leave the floor and chairs alone and to have an acoustic

material applied to the wall or ceiling. If we were to cover the entire wall with Acousti-Celotex type C-4, the number of absorption units for this treatment alone would be 2376 (2400  $\times$  .99). This would be too much and would make the room rather dead, because the reverberation period would then be only about .4 second. To come out around 700 units, so that with an audience (200 units) the period will be about one second, we need only about 600 feet of this acoustic material on the wall. Therefore, it is possible to hang several panels of this material at various points along the wall and thus deaden the room just as much as it would be deadened if

we were to hang drapes over all the walls and put a carpet on the floor.

As you can see, there are a number of different things that can be done to change the reverberation period of a room. Initial costs, ease of application, and upkeep costs must all be considered in selecting a method of treatment. This is particularly true when a large auditorium is to be treated, because the cost of such a project may be very high.

An auditorium intended to seat several thousand people is a difficult problem to treat acoustically because of the fact that the audience may vary in size from just a few people to a capacity crowd. There will obviously be a tremendous difference in the absorption of the auditorium under the two extreme conditions; if the treatment is such that the reverberation period is correct when the auditorium is filled to capacity, the reverberation will be excessive when the audience is small. Usually the treatment for such an auditorium is calculated on the assumption that it is to be only moderately full. Then, as the audience varies around this average, the period is made slightly higher or lower, but never varies as much as it would if we assumed either zero or a capacity audience.

### FOCAL POINTS AND DEAD SPOTS

Another factor that must be considered in planning a p.a. installation is the possibility that the shape and size of the room will cause unequal

sound distribution over the floor area. An example of just such a room is shown in Fig. 41. The dome-shaped ceiling of this auditorium provides sound paths that tend to concentrate the sound from the origin to a spot in the balcony. At this particular spot, the sound will be excessive.

On the other hand, it is equally possible for the shape of the room to cause dead spots—points at which

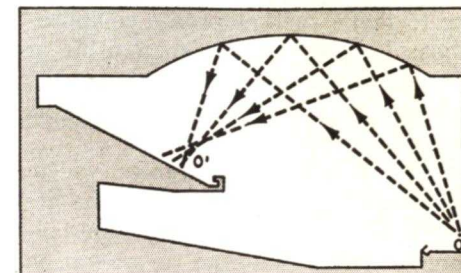

FIG. 41. Sounds reflecting from various points on the curved ceiling of this auditorium are brought to a focus at a single small area in the balcony, making the volume level there considerably higher than it is elsewhere.

there is sound cancellation because the sounds arrive out of phase over two different paths. Such spotty responses are not likely in small rooms but are quite common in large auditoriums. In such cases, it is either necessary to treat the room acoustically to break up these reflection points or to place the loudspeakers so that the sound is more evenly distributed. The latter method is usually preferable, since it is less difficult and expensive than is changing the contour of a room.

# Determining Acoustical Powers Needed

From the foregoing section, you can see that there are a number of factors involved in determining how much acoustical power will be necessary to obtain the desired performance from a p.a. system in a given location. Engineering methods can be used to calculate the exact power necessary, but the practical sound man seldom bothers to make such elaborate computations. Instead, he uses some table or graph that gives a general idea of the power that should prove suitable under average conditions.

Most such published tables, which, incidentally, may be found in the literature of the loudspeaker manufacturers, assume that the reverberation period of the room is normal for its size and for the conditions that will be met. If you find upon examination that the room is not normal in this respect, a correction must be made to make the room suitable for a permanent sound installation.

If the reverberation in the room is reasonable or is made so, we can find the power necessary if we know the volume of the room in cubic feet and the noise level that can be expected.

Unless you are going to go to the expense of purchasing or renting a noise level meter to check the exact level, you will have to depend on the averages that have been found for

installations that are similar.

Tables, such as Figs. 42 and 43, give acoustic powers needed for particular noise levels and room volumes. To use them, you will have to estimate or determine the noise; the tables then give the approximate acoustic power needed for a room having the area of the one in which you are interested. Notice that the *minimum* powers for the reproduction of speech or music are given—more power may be needed if the room is dead or if it is necessary to overcome dead spots or reflections in the room.

Once you have determined how much power is needed, you will have to divide the number of acoustic watts by the speaker efficiency to get the electrical wattage the amplifier must supply. For example, if the acoustic power is .5 watt, and you are using ordinary cone loudspeakers, which are about 2% efficient, the amplifier must have an output of 25

$$\frac{.5}{.02} = 25.$$

Generally, it is best to choose an amplifier rated somewhat above this minimum, to allow for losses in the transmission lines, and for possible increases in the noise level.

The tables in Figs. 42 and 43 are incomplete, since they cover only a

Noise Level (db) Above Threshold of Hearing	Area (sq. ft.) 500-2000 Assumed Room Height (ft.) 10-15	Area (sq. ft.) 2000-5000 Assumed Room Height (ft.) 15-20	Area (sq. ft.) 5000-10,000 Assumed Room Height (ft.) 20-25	Area (sq. ft.) 10,000-30,000 Assumed Room Height (ft.) 25-35	Area (sq. ft.) 30,000-70,000 Assumed Room Height (ft.) 35-50
70	0.001-0.004	0.004-0.010	0.010-0.019	0.019-0.056	0.056-0.126
80	0.012-0.044	0.044-0.100	0.100-0.199	0.199-0.562	0.562-1.26
90	0.126-0.447	0.447-1.0	1.0-1.99	1.99-5.62	5.62-12.6
100	1.26-4.47	4.47-10.0	10.0-19.9	19.9-56.2	

Courtesy John F. Rider

FIG. 42. Minimum acoustic power in watts required to override noise for reproduction of speech only in indoor coverage areas indicated. Areas are in square feet.

Noise Level (db) Above Threshold of Hearing	Area (sq. ft.) 500-2000 Assumed Room Height (ft.) 10-15	Area (sq. ft.) 2000-5000 Assumed Room Height (ft.) 15-20	Area (sq. ft.) 5000-10,000 Assumed Room Height (ft.) 20-25	Area (sq. ft.) 10,000-30,000 Assumed Room Height (ft.) 25-35	Area (sq. ft.) 30,000-70,000 Assumed Room Height (ft.) 35-50
70	0.039-0.141	0.141-0.316	0.316-0.631	0.631-1.78	1.78-3.98
80	0.398-1.41	1.41-3.16	3.16-6.31	6.31-17.8	17.8-39.8
90	3.98-14.1	14.1-31.6	31.6-63.1		

Courtesy John F. Rider

FIG. 43. Minimum acoustic power required to override noise for normal p.a. requirements for speech and music reproduction in indoor coverage areas indicated. Areas are in square feet.

few noise levels. However, the trend of powers is obvious, so you can fill in for lower or higher noise levels by the simple process of dividing or multiplying by a factor of 10 for each 10 db decrease or increase in noise.

In attempting to estimate the amount of noise, you can use tables like that shown in Fig. 35 or charts that you obtain from loudspeaker manufacturers. Such loudspeaker charts give usual noise levels and the power needed for various room volumes when using certain particular loudspeakers. These charts apply only to the loudspeakers made by that manufacturer—you should obtain the one for the brand in which you are interested, because differences in efficiencies and coverage angles exist that make them wrong for other brands.

Let's sum up what we have learned about calculating how much power is needed for an indoor installation. First, you must determine whether the room has the proper reverberation period or needs acoustic treatment. Then, from a table or chart, you must find how much acoustic power is needed for a room of the size of the one with which you are concerned, taking into consideration the average noise level of the room and whether music and speech, or speech alone, is to be carried by the p.a. system. Naturally, even more acoustic power is needed for the high-fidelity reproduction of music than is necessary for

ordinary dance music or for speech.

To convert acoustic power into electrical power, you must know the efficiencies of the loudspeakers you intend to use. As we said earlier, cone loudspeakers are commonly considered to be 2% efficient in baffles and 5% efficient in projectors. By dividing the acoustic power level (in watts) by the speaker efficiency (expressed as a decimal), you will find the electrical power needed.

## SOUND OUTDOORS

We have no reverberation problems outdoors but do have the problem of rapid attenuation of the sound. Since there are no walls to reflect energy back to the audience, sound power goes down 6 db for each doubling of the distance from the loudspeakers to the listener.

Horn loudspeakers are generally used in these installations. The horns may have either narrow or wide coverage angles, depending on the installation. Both types have their advantages and disadvantages. Horns with wide coverage angles cover a larger area, but since the sound is spread out over this area, it is weaker at any distance from the horn than it would be for a horn with a narrower coverage angle. On the other hand, if we use narrow-angle horns and must cover a wide area, we have to use more of the horns to cover this area properly.

Noise Level (db)	10-30 ft.	30-75 ft.	75-150 ft.	150-300 ft.	300-500 ft.	500-1000 ft.
70	0.002-0.017	0.017-0.112	0.112-0.501	0.501-1.78	1.78-5.01	5.01-20.0
80	0.020-0.178	0.178-1.12	1.12-5.01	5.01-17.8	17.8-50.1	
90	0.200-1.78	1.78-11.2	11.2-50.1			
100	2.0-17.8	17.8-11.2				

Courtesy John F. Rider

FIG. 44. Minimum acoustic power required to override noise for reproduction of speech outdoors for coverage of indicated distance in feet. A coverage angle of 30° is assumed. More power is required if larger angles of coverage are used.

Fig. 44 shows a table for determining the sound power necessary outdoors. Notice that the table is for a certain specified coverage angle of the horn.

A comparison of Fig. 44 with Figs. 42 and 43 shows that the acoustic power needed outdoors is far higher than it is for indoor installations. However, since horns have a 15% efficiency, the actual electrical power increase needed is not as great as you might at first imagine. For example, if the indoor acoustic power needed is 1 watt, and 2% efficient loudspeakers are used, 50 electrical watts are necessary. With a 15% efficient loudspeaker, 1 acoustic watt is obtained from only about 6 electrical watts, however. Fifty watts delivered to 15% efficient loudspeakers will deliver as much as 7.5 acoustical watts, which is a respectable amount of sound power.

## PLACING LOUDSPEAKERS

Either indoors or outdoors, once we decide on the electrical power that will be needed, we must then determine both from the power level and from the surrounding conditions the number of loudspeakers that will be needed. Cone loudspeakers are available in various power-handling capacities from as low as 1 watt to perhaps 40 watts. If the necessary amplifier power level is higher than one loud-

speaker can handle, then obviously more than one must be used. Most driver units are rated at about 25 watts, but they operate satisfactorily from powers as low as 6 to 8 watts. However, if the output from the amplifier is greater than 25 watts, again more than one loudspeaker is needed.

Extra loudspeakers may be needed to give the proper coverage for the area. There are locations at which it is best to use a number of loudspeakers and divide the sound for better dispersion. In some instances, such as when sound is distributed to hotel or hospital rooms, this is a necessity—a small loudspeaker must be placed in each room, which of course means that there will be quite a number of loudspeakers.

Even when the major sound distribution comes from one or two large loudspeakers located near the source of sound, a few supplementary loudspeakers may be necessary to take care of spots that would otherwise be dead.

Incidentally, when the loudspeaker is in the room in which the performance is occurring, it is considered good practice to get the loudspeakers somewhere near the source of sound, so that the sound will apparently be coming from its source. This, of course, introduces the problem of feedback to the microphone through the air, which means that the loud-

speakers must be so enclosed or so positioned that the feedback will not be excessive.

Of course, this does not mean that all the loudspeakers must be grouped in one place. Even if the main ones are so grouped, there may have to be supplementary loudspeakers to feed sound into dead spots, under balconies, etc.

When you are feeding sound into rooms other than the one in which the performance is occurring, you do not have to worry about feedback to the microphone. It is possible to use a single cluster of loudspeakers in such a room, but because sound may be excessively loud near the loudspeakers and too weak farther away, it is more common in this kind of installation to scatter the loudspeakers about. The only problem here is to make sure that the coverage is approximately uniform over the entire room.

We will go into greater detail on loudspeaker placement when we take up typical installations elsewhere. For now, let's cover a few general rules that will prove helpful in any installation.

**Loudspeaker Phasing.** When more than one loudspeaker is used in a cluster, it is important that the voice coils be connected so that the sounds from these loudspeakers are in phase. If the loudspeakers are outwardly identical, you can usually assume that the connections from the voice coil to the terminals on the loudspeaker are the same on each, and you can connect similar terminals together when the loudspeakers are in parallel, as shown in Fig. 45A. Fig. 45B shows the proper way to connect loudspeaker voice coils in series.

It is always possible, however, that the manufacturer has reversed one of the windings; if so, neither of these connections will be right for these

particular loudspeakers. When the loudspeakers are out of phase, the sound from them tends to cancel. Therefore, the correct in-phase connection will be the one that gives the louder response for the same fixed input. If there is any doubt about this, you can make the simple test of listening to the loudspeakers while you reverse the connections to one of them.

You don't have to worry about the phase of loudspeaker connections when the loudspeakers are very widely separated, particularly when they are outdoors.

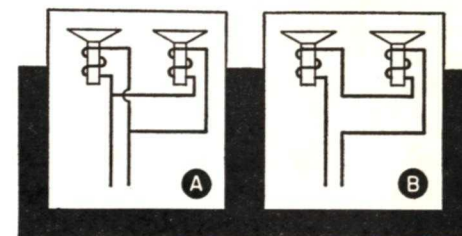

FIG. 45. Proper method of connecting loudspeaker voice coils in parallel (A) and in series (B).

**Coverage Angles.** Loudspeakers in box baffles have fairly wide coverage angles at low frequencies, but the angle of coverage for the middle and high frequencies is more restricted. For this reason, loudspeaker placement may become rather critical. If it is desired to have the sound apparently come from the source on a stage, the loudspeakers should preferably be mounted above the stage and should be tilted downward to point toward the audience. If there are two loudspeakers, better results can be obtained by placing them to the right and left of the center of the stage, turning them so as to give the greatest coverage.

If a room is to be covered by a series of separated loudspeakers instead of by a centralized group, you

can either locate them along the longer wall or use ceiling loudspeakers that have 360° coverage. Incidentally, when loudspeakers are located along a wall, they should never be more than about 40 feet apart; if they are more widely separated than this, there will tend to be an echo effect as sound comes to listeners from different loudspeakers.

In general, outdoors, it is preferable to have the loudspeakers in a single cluster if possible. Of course, it may not be possible to use a single cluster. In football stadiums, for example, it may be necessary to string the loudspeakers around so that each covers a portion of the audience.

### MICROPHONE PLACEMENT

The proper placement of microphones is often a problem. Of course, if voice is being picked up, it is common practice to have the microphone directly in front of the person speaking. Stage presentations, however, often require not only that the sound be picked up over a wide area but also that the microphone be concealed. Generally, in such cases, from two to four microphones are located in the footlight region of the stage, or several microphones are suspended from above the stage so as to cover as much of the area as possible.

When instrumental music is to be picked up, it is often necessary to locate the microphone or microphones very carefully with respect to the va-

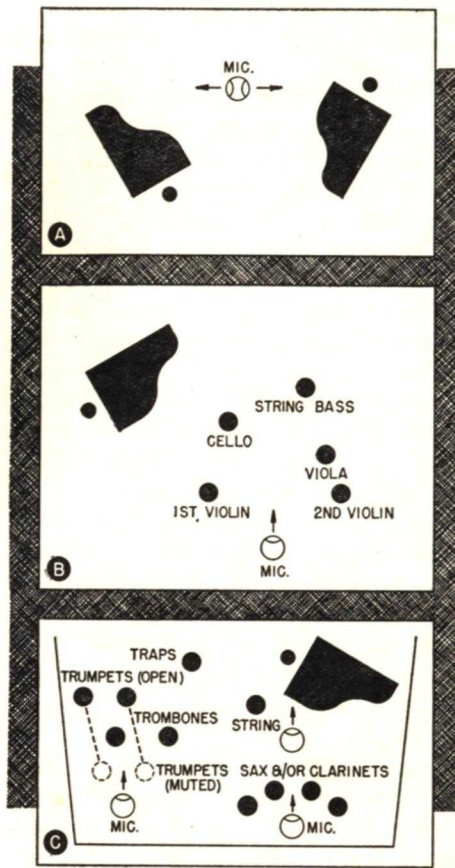

FIG. 46. Practical microphone placements for picking up (A) a 2-piano team, (B) a small salon orchestra, and (C) a dance orchestra.

rious instruments being used. Several typical examples are shown in Fig. 46. In cases of this kind, the only practical way to find the right microphone positions is to be present at a rehearsal and try various positions until the proper ones are found.



## THE MAN WHO COUNTS

The man who counts is the man who is decent and who makes himself felt as a force for decency, for cleanliness, for civic righteousness. First, he must be honest. In the next place, he must have courage; the timid man counts but little in the rough business of trying to do well the world's work. In addition, he must have common sense. If he does not have it, no matter what other qualities he may have, he will find himself at the mercy of those who, without possessing his desire to do right, know only too well how to make the wrong effective.—Theodore Roosevelt.

\* \* \*

This statement of Theodore Roosevelt's has always appealed to me as being a very sound piece of practical advice. Read it carefully. It can be of real value to you.

*J. E. Smith*