

RECEIVER REVITALIZATION

TUBE TESTERS

Finish

45RH-1

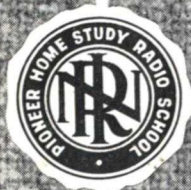

NATIONAL RADIO INSTITUTE

WASHINGTON, D. C.

ESTABLISHED 1914

STUDY SCHEDULE No. 45

For each study step, read the assigned pages first at your usual speed, then reread slowly one or more times. Finish with one quick reading to fix the important facts firmly in your mind. Study each other step in this same way.

- 1. Revitalization and Radio Measurements.....Pages 1-3
The meaning of revitalization and the need for certain measurements for most accurate results are the subjects of this section.
- 2. Sensitivity Measurements.....Pages 3-12
The most used revitalization steps are those to restore sensitivity. Here are the methods of checking sensitivity to determine what it is, and to determine how much improvement has been made. Laboratory procedures and methods using a signal tracer are covered.
- 3. Selectivity and Fidelity Measurements.....Pages 13-18
Both laboratory and service methods of measurement are covered. The short-cuts used by servicemen are particularly stressed.
- 4. Miscellaneous Measurements.....Pages 19-21
How to check: the hum level; power consumption; frequency shift; for dead spots; image rejection; and noise.
- 5. Receiver and Part Revitalization.....Pages 22-27
The methods of overhauling a radio, with particular attention to the steps which pep up receivers.
- 6. Tube Testers.....Pages 28-36
This section covers the practical types of testers developed for servicemen. The methods of testing for tube quality, the variations permitted, special tests, and the proper tube-testing routine are all covered.
- 7. Answer Lesson Questions, and Mail your answers to N. R. I.
- 8. Start Studying the Next Lesson.

RECEIVER REVITALIZATION

TUBE TESTERS

Revitalization and Radio Measurements

REVITALIZATION is the process of bringing a receiver back as nearly as possible to the condition it was in when new. Strictly speaking, any repair procedure could be called a revitalization, but the term has come to mean the process of overhauling a radio receiver.

If a receiver is normal except for some one particular defect (excessive hum, oscillation, etc.), you would of course concentrate on finding and remedying the cause of the defective operation. In most cases, troubles of this kind will be easily localized by the normal servicing procedures given elsewhere in your Course. Then, at some time during the service job, you usually will carry out two steps which are revitalization procedures, in that the receiver operation is being improved. These steps are: 1, test the tubes and recommend the replacement of weak ones; and 2, check the alignment and realign if necessary. These revitalizing steps are so much a part of the service job that most servicemen do not look upon them as revitalization. Instead, they consider revitalization as the procedure followed when servicing a radio which is generally run down and insensitive, but which exhibits no specific defect in its operation.

Using this meaning of revitalization, there are two methods of approach to the problem. One is a brute force method of repairing or replacing every suspected part. While

this will usually improve the over-all receiver performance and will probably result in the replacement of any defective parts, it is generally a lengthy and expensive process, and it is not certain to give the results you want. A more scientific approach is to take measurements to determine just what the receiver characteristics actually are. Comparing the results of these measurements with the ratings of the receiver will give you a fairly good idea of the actual condition of the set and indicate what you must do to improve it. Then, after making each repair or adjustment, you can check your progress by repeating the measurements to see how much improvement has been made.

Obviously, you'll be more certain of results if you follow this second method which we are going to study in detail in this lesson. But before we take up the actual procedures of revitalization, let's learn something about the measurements which can be made on radio receivers.

THE IMPORTANCE OF RADIO MEASUREMENTS

Measurements of radio characteristics were at one time limited entirely to laboratories. The expensive equipment and the exact, time-consuming, scientific methods needed caused radio servicemen to "steer clear." Today, however, the more widespread use of vacuum tube volt-

meters, the cathode ray oscilloscope, signal tracers, etc., has placed the necessary equipment in the larger service shops. Further, set manufacturers have begun to release measurement data made with such service equipment, so the problem of getting a useful measure of sensitivity, selectivity, fidelity, etc., has been greatly simplified. As a result, many servicemen are using these measurements as a means of determining radio characteristics more exactly.

► Ordinarily, the only guides a serviceman has to the performance a particular radio receiver should exhibit are data which may be a part of the service information on the set and the statements of the set owner. Of course, it is possible to judge the performance of some particular model after having worked on several identical receivers. However, this experience may not be too helpful when you meet a different model, for different types of radios vary considerably in their characteristics.

Contrary to popular opinion, the number of tubes in a receiver shows little about its performance. It is quite possible, for example, for a 6- or 7-tube receiver to have far greater sensitivity than a receiver with 12 or 15 tubes. Even receivers with the same number of tubes may be of different design and therefore have far different performances. Thus, a 5-tube a.c. operated receiver with a power transformer may have a far greater output than a 5-tube a.c.-d.c. or a 5-tube battery operated set, while these receivers may have better selectivity or better sensitivity characteristics than the a.c. receiver.

► Today, it is possible for the radio engineer to build into the receiver any desired amount of selectivity, sensitivity, and fidelity, within the limits of cost and the necessary compromises between these factors. The engineer,

in designing a set, takes into consideration the use to which the receiver is to be put and the sales features desired. A communications set, for instance, must have a high sensitivity and must be extremely selective, but it does not need much in the way of fidelity. (Frequencies above 3500 cycles are not needed for voice or code transmission, and cutting them off gives less noise and better selectivity.) On the other hand, a high-fidelity receiver is usually made relatively insensitive, with rather poor selectivity, but with very good fidelity or tone quality. The average broadcast set is some compromise in between these two extremes.

The fact that such wide variations exist in the designed performances of radios make it desirable to use fairly accurate measurements if you are going to revitalize receivers which have lost their pep. You must have some clear way of comparing the actual performance of a set with the performance it was designed to have—otherwise, you may waste a great deal of time attempting to give a receiver characteristics which were never built into it and which it cannot have without extensive modifications. Only actual measurements of performance will let you make such a comparison.

Comparison of actual performance with the rated value by means of measurements will be of particular help to you when a set owner complains about the lack of selectivity, fidelity, or sensitivity in his radio. Measurements will show you if the complaint is really justified and if the condition can be corrected at reasonable expense—or if it would be better (and cheaper) for the set owner to buy a new radio. And, finally, measurements are extremely useful as checks on your work, since they will show definitely how successful you have been in your attempts to bring

the set back to “good as new” condition.

Naturally, as a serviceman, you are not going to have the equipment or the time to make laboratory-type measurements. In recognition of this fact, the modern practice is for the set manufacturer to take laboratory measurements in a standardized manner so as to compare receiver characteristics, then to give service data measurements taken with service-type instruments. However, even though you may never make laboratory-type measurements yourself, it is desirable for you to know how they are made, what they mean, and how close service-type measurements are to them in results. Then you will be able to interpret more clearly the results you get from measurements made with service instruments.

► In this lesson we shall give a brief description of the manner in which the set manufacturers make their measurements, so you can understand the exact meaning of the ratings you may find in radio service data. Then,

we shall show how simplified measurements can be made with service equipment, which will permit an approximation of these results and give you some means of comparison.

Of course, these measurements will not be needed so very often in your service work, as by far the greatest number of troubles will be straightforward cases, easily and directly solvable by the professional servicing techniques you have already studied. Furthermore, as your experience grows, you will develop the knack of judging receiver response, so you will need to make measurements only in those comparatively rare cases where ordinary methods fall down.

Among the measurable response characteristics of a receiver are: sensitivity; selectivity; fidelity; hum level; noise level; frequency shifts; image rejection; dead spots; and receiver power consumption. Let's see just how the measurements of these characteristics can be made.

Sensitivity Measurements

The receiver sensitivity is a measure of its ability to pick up and properly reproduce weak signals from low powered or distant stations. A loss of sensitivity first shows up as an inability to pick up weak distant stations, and then progresses to weak reception even from locals.

We could measure the sensitivity of a receiver by determining the weakest possible signal which would give even the slightest output from the receiver, if we wished to do so. However, a more useful value is found by measuring the input signal which will give some definite rated output. This lat-

ter measurement is far more valuable because it gives some idea of how weak a signal can be and still be amplified enough by the set to give enjoyable reception.

LABORATORY SENSITIVITY MEASUREMENTS

Let us first consider receivers designed to operate from regular antennas (not loop aerials). To measure the sensitivity of the receiver, we must be able to measure both the signal voltage fed into it and the output voltage of the receiver.

It is not practical to radiate a sig-

nal and depend on an antenna for pickup, as there is a possibility of the set picking up the signal directly. Just feeding from the signal generator directly into the antenna-ground terminals will upset the input circuit of the receiver, due to the signal generator loading effects. The usual way of solving this problem is to feed a measured signal voltage into the radio receiver through what is called a dummy antenna. This dummy antenna is a combination of parts which

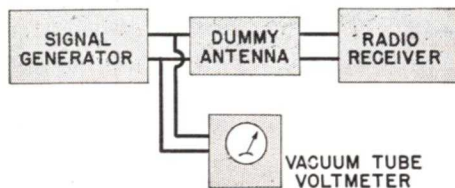

FIG. 1. The connections for making a sensitivity check.

simulates the inductance, capacity, and resistance of an ordinary receiving antenna. When the measured signal is fed through this device, the receiver "feels" an antenna at its input and will react as if it were connected to an average antenna.

The input signal must be measured with accuracy if the sensitivity measurement is to mean anything. One method of making this measurement is to use a sensitive vacuum tube voltmeter, as shown in Fig. 1. However, modern standard* signal generators having a controlled output are used in most laboratories. In these, a built-in vacuum tube voltmeter is used to adjust the signal level fed into an attenuating network. The controls of the attenuator are marked directly in microvolts output. (A microvolt is one-millionth of a volt.)

* Signal generators of the "standard" type are so named because they are made to laboratory specifications and have extremely accurate and reliable output signals.

Usually, there will be two controls, one reading from zero to 10, while the other is a switch type control varying the output in steps of ten. (It reads 1, 10, 100, 1000, and 10,000, and the output is found by multiplying the two dial readings.) This permits the output to be varied from a fraction of 1 microvolt up to 100,000 microvolts on most standard signal generators.

Fig. 2 shows the connections for a standard signal generator, and also shows the components of a standard dummy antenna. As we said, this particular arrangement of parts has been chosen to simulate the effects of an antenna on the receiver input, so the measurement will be in terms of signal strength fed into an average antenna.

The Dummy Load. To measure the output, the loudspeaker voice coil is disconnected and a resistor is used in its place, as shown in Fig. 2. The resistor R is called a dummy load, and is chosen to have the same ohmic

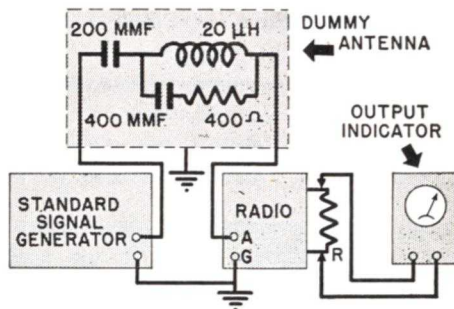
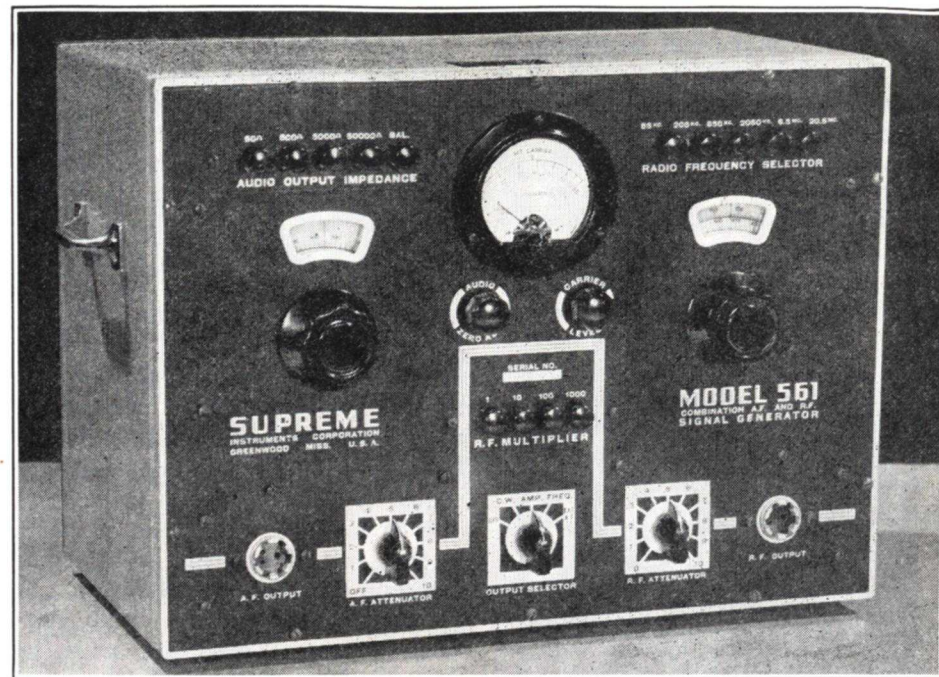

FIG. 2. Standard signal generators have built-in level indicators, so they do not need an external v.t.v.m. for measuring the receiver input. The parts values for a dummy antenna are given here.

value as the voice coil impedance. The voltage across this resistor is measured with an accurate a.c. voltmeter. Once we know the voltage and the resistance, we can determine the power output. ($P = E^2 \div R$)

► An equally acceptable way to measure the output is to place a



Courtesy Supreme Inst. Corp.

A standard signal generator intended for the serviceman. Frequency ranges are selected by push-buttons at the upper right. When the carrier level control is adjusted to give an indication at the point marked on the meter, the output in microvolts will be indicated by the output control setting. The r.f. attenuator reading is multiplied by the r.f. multiplier push-button being used. There is a built-in variable frequency audio oscillator, and the percentage of modulation is indicated on the meter.

resistance in the plate circuit of the output tube or tubes, as shown in Fig. 3. Leaving the secondary winding of the output transformer open makes the primary impedance become practically infinite, so the dummy load resistor R is chosen to give the proper load impedance for the tube used. The advantage of using the circuit shown in Fig. 3 lies in the fact that the voltmeter need not be so sensitive. The resistance value of R in Fig. 3 is much higher than that of R in Fig. 2, and a higher voltage is developed across it for the same power output.

The Standard Output. The standard output power used for sensitivity measurements is .05 watt (50 milliwatts) for a set which has an undistorted output power of 1 watt or

less, and is .5 watt for a receiver with an undistorted output power of 1 watt or more.

Thus, on a low-powered set, we adjust the input signal until the output indicator used with the set shows .05 watt output; similarly, with a high-powered set, we adjust the input until an output of .5 watt is indicated. We can then tell from the amount of input necessary to produce this standard output just how sensitive the set is.

Assuming we are using the 50 milli-watt output level, which is the one most often used, you can see that the voltage across a low resistance will be small. (This voltage is found from the formula, $E = \sqrt{P \times R}$.) Thus, if the resistance has a value of 5 ohms and the power is .05 watt, the voltage

is only .5 volt. If the resistance is higher, the voltage will be higher, so the method illustrated in Fig. 3 is somewhat more desirable.

Voltages equivalent to standard output (.05 watt) for various load resistance values are given in Fig. 4.

Sensitivity Variations. When we make measurements with the standard set-up of Fig. 2, what frequency should we use? You probably know from tuning your radio receiver that

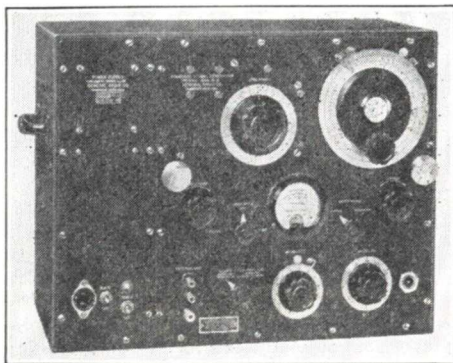

Courtesy General Radio Co.

A standard laboratory type signal generator. The output is calibrated in microvolts and the percentage of modulation is variable and indicated on the meter.

programs from different stations on the dial do not all come in with exactly the same volume and power. Partly this is caused by differences in the distances between the stations and the receiver and differences in the powers of the stations, but another important cause is the fact that the sensitivity of a receiver is not the same at all frequencies. Therefore, as we take measurements over a band of frequencies, we will find that different amounts of input will produce the standard output.

For this reason, we cannot say that a receiver has a certain sensitivity without specifying the frequency at which the sensitivity was measured. A typical curve showing the variation

in sensitivity over the broadcast band is given in Fig. 5.

Thus, to make a really complete study of the sensitivity of a receiver, it is necessary to start at one end of the band, tune the receiver and generator to the same frequency, and note the microvolts input necessary to produce the standard output. The measurement must then be repeated at other points throughout the frequency range of the set.

► Of course, for comparison purposes, we do not need to measure the sensitivity over the entire band as long as we know what the sensitivity should be at some particular frequency and make our measurements at that same frequency.

Signal Generator Modulation. As the output voltage is an audio voltage, the signal generator must be modulated a certain exact amount at a certain frequency for the output measurements to be reliable. Standard measurements are made with the signal generator modulated 30% by a

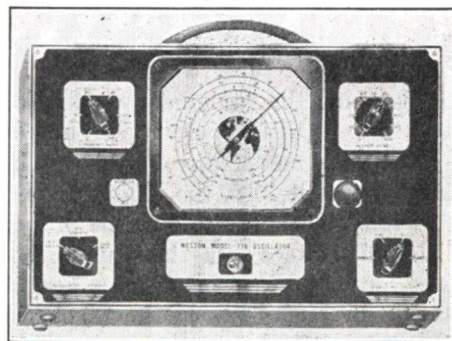

Courtesy Weston

Another service-type signal generator. The output controls are calibrated in microvolts, and the output level is held constant by a built-in automatic level control circuit. The audio modulation is a 400-cycle signal, and the percentage of modulation is fixed at 50%. This is above the 30% value used in standard sensitivity measurements. Radios would have an apparent sensitivity better than they actually have if this signal generator is used. Otherwise, this is an excellent general purpose signal generator.

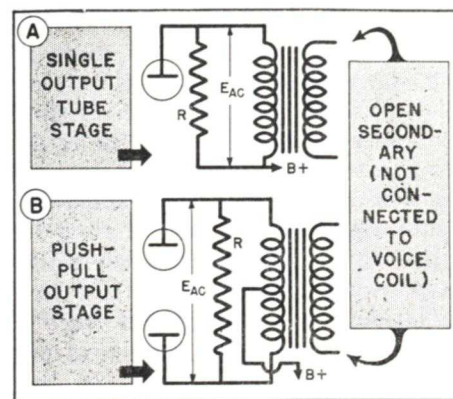

FIG. 3. These connections are used when the dummy load resistor is connected in the plate circuit of single-ended (A) and push-pull (B) output stages.

400-cycle audio signal. The modulation percentage must be accurately adjusted. Most laboratory-type standard signal generators have a means of varying modulation percentage and use a meter to indicate the exact percentage used.

Loop Aerials. When the receiver has a loop aerial, it is not possible to substitute a dummy antenna for the loop. When measurements are made on such a receiver, one method is to use a carefully designed radiating loop antenna, connected to the signal generator and then arranged a certain distance from the receiver loop, as shown in Fig. 6A. From the dimensions of the two loop antennas and their distance apart, it is possible to calculate the energy fed into the receiver loop and, from this, the input to the receiver.

► Another way of accomplishing the same result is shown in Fig. 6B. A small resistor is inserted in series with the receiver loop aerial, and the signal generator output is applied across it. The current flow through the resistor is measured by the meter *M*. From this, the voltage drop across the resistor—that is, the signal volt-

age introduced into the loop circuit—is calculated.

SENSITIVITY TESTS WITH SERVICE EQUIPMENT

The serviceman with a great amount of practical experience rarely needs to make sensitivity measurements. He may put a set on the test bench and simply try tuning in a number of stations on the band. From experience, he knows what other sets of various types will do in his particular location on the same antenna, and he judges the performance of the radio on which he is working by the way it acts. If he knows that certain distant stations can be tuned in only by a receiver having good sensitivity, and finds he can pick up these stations on the set being checked, he knows that the sensitivity of the radio he is testing is pretty good.

He may also judge the sensitivity by the action obtained when he tunes off resonance. Normally, he would

VOLTAGES FOR STANDARD OUTPUT OF .05 WATT

Dummy Load	Volts	Dummy Load	Volts
1	.22	1000	7.1
2	.32	1500	8.7
3	.39	2000	10.0
4	.45	2500	11.2
5	.50	3000	12.3
6	.55	3500	13.2
7	.59	4000	14.1
8	.63	4500	15.0
9	.67	5000	15.8
10	.70	5500	16.6
11	.74	6000	17.3
12	.78	6500	18.0
13	.81	7000	18.7
14	.84	7500	19.4
15	.87	8000	20.0

FIG. 4. This table gives the voltages that indicate a .05-watt output across various load resistance values.

expect the noise level to increase greatly as the set is tuned away from a station signal and the a.v.c. action increases the set sensitivity to maximum. If he finds that he doesn't get much of a "roar" as he tunes off resonance, he knows the set does not have very much sensitivity. If the receiver is a type which should be reasonably sensitive, he would then go to work to discover the reasons for the lack of sensitivity.

A serviceman with less experience is unable to judge radio receivers this way, and even an expert can be fooled occasionally, so a more exact procedure is desirable.

Better and better equipment is be-

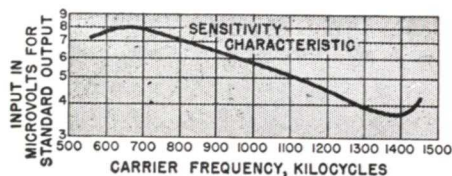

FIG. 5. The sensitivity varies over the tuning band, as shown here. The maximum sensitivity is indicated by the least input which will give the standard output, so this particular set is most sensitive near 1400 kc. Sometimes the readings near the center of the tuning range are given as the average over-all sensitivity value.

ing made available to servicemen, so today many have standard signal generators which they use in their service shops for alignment purposes. If you have such a standard signal generator (with an output accurately calibrated in microvolts), you can measure receiver sensitivity by the same method used by the set manufacturer.

SENSITIVITY TESTS WITH SIGNAL TRACERS

Checking the set sensitivity in the manner just described will give the actual over-all sensitivity of the receiver. Comparing this with the manufacturer's ratings gives valu-

able information about the over-all gain of the receiver. If there is any wide difference between the measured sensitivity of the receiver and its proper value, trouble in the radio is indicated. Unfortunately this indication does not tell which stage the trouble is in, so the entire receiver must be carefully checked, using the methods given elsewhere.

The development of signal tracing equipment has, to a great extent, permitted quick localization of the defective stage. A signal tracer cannot be depended on to indicate accurately the number of microvolts of signal at any point in the radio. However, it can be used to measure the ratio of the output to the input of any desired stage. The ratio of the output to the input is a measure of the gain or amplification of the stage and is accurately determined by the signal tracer, for any errors caused by the tracer will be in both measurements and will cancel each other. Since the receiver sensitivity depends on the amplification obtained in each stage, this measurement of stage gain is an indirect measure of sensitivity. Even more important, if you know the gain which should exist in each stage, you can localize the defective stage (or stages) by making stage-by-stage measurements with the signal tracer.

As a check of the over-all gain only indicates that a defect exists but does not localize the trouble, you can see that the signal tracer, with its ability to localize the defective stage, is more valuable in service work.

Manufacturers' Gain Values. Before stage gain readings can mean much, we must know what to expect from each particular stage. In recent years, receiver manufacturers have cooperated in furnishing this data to servicemen. Some give the gain data directly on the diagram, while others

show it in a table apart from the diagram.

Fig. 7 is an example of the diagram system. Notice the gain values given above the schematic. As you can see, the input gain is figured at 600 kc. At that frequency, the gain from the antenna to the first tube grid is 2. If we have, for example, a 30-microvolt 600 kilocycle signal between the antenna and ground (chassis ground) the circuit should give us two times this signal level (a 60-microvolt sig-

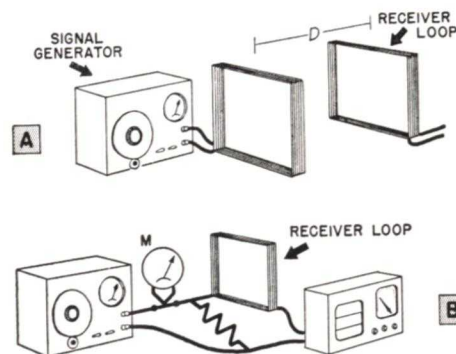

FIG. 6. Two ways of feeding a signal into a loop antenna. The practical serviceman would use the first method, winding a loop of 5 or 10 turns to connect to his signal generator. He won't know what the induced voltage is, so cannot determine the Q of the loop, but using a signal tracer will permit measurements from the loop onward.

nal) between the first tube grid and chassis ground, if everything is normal.

With the 600-kilocycle signal still tuned in, there is a conversion gain of 60 in the first detector-oscillator tube. This means that if we measure the 600-kilocycle signal fed to the grid of the 12SA7 tube, then measure the 455 kc. i.f. signal developed between this tube plate and the chassis ground, we should have an increase of about 60. Thus, if we continue with our example and use a 60-microvolt signal as the input to the 12SA7 tube, we should have 60 times 60 or 3600 microvolts of

i.f. signal between the plate of this tube and ground.

► Notice, however, that the gain of this tube will vary with the grid bias, which is controlled by the a.v.c. circuit. If we allow the normal a.v.c. action to occur; strong signals will increase the bias and hence reduce the gain. For the gain measurement to mean anything, we must block the a.v.c. action.

Therefore, when any measurements are made in the r.f. and i.f. sections of a receiver, it is necessary to disconnect the a.v.c. circuit from the source of a.v.c. voltage and substitute in its place a certain value of fixed bias. The fixed bias value must be that recommended by the set manufacturer—usually 3 volts. To make measurements on the receiver shown in Fig. 7, you should disconnect resistor R_2 (either end) and place a 3-volt bias from a battery between the grid return lead and chassis as shown by the dotted lines in Fig. 7. Of course, you must observe the proper polarity in connecting this battery.

► Continuing with our example, the next gain measurement is taken from the plate of the 12SA7 tube to the grid of the 12SK7 tube. This measures the gain of the i.f. transformer, which is given as .5 (the same as $\frac{1}{2}$). This means that the signal in the secondary of the transformer is only half as strong as that in the primary; in other words, we actually get a loss in this transformer. Thus, if we have 3600 microvolts between the plate of the 12SA7 and the chassis, we can get only one-half this, or 1800 microvolts, at the grid of the 12SK7 tube.

In the next stage, there is a gain of 100 between the grid and the plate of the i.f. amplifier, then a loss of one-half in the second i.f. transformer.

There is a loss (not shown on the diagram) in the second detector too.

The audio output of the detector depends on the percentage of modulation of the input signal.

Following the audio signal further, we find a gain of 40 in the triode section of the 12SQ7 tube. (Notice that in making the measurement on the audio tube stage we are comparing the signal levels found at its grid and plate terminals, and are measuring the 400-cycle audio modulation signal from the signal generator.) Finally, there is an audio gain of 10 between the grid and plate of the 50L6 output tube.

Using Signal Tracers. In making gain measurements with a signal tracer, you do not worry about the actual amount of microvolts. Instead, you are interested in the ratio between the two points where you make your measurement. You can make your measurements either with a signal tracer which gives a meter reading or with one which uses a magic-eye indicator.

If you use the second type of tracer, you will determine the gain ratio from the control settings. First, connect the signal tracer probe to the input side of the stage, feed in a signal, and adjust the controls until the eye closes. Make a note of the control settings which close the eye. Then, move the probe to the output side of the stage and adjust the controls until the eye is again closed. Dividing the second gain control reading by the first will give the relative increase in gain.

If your signal tracer indicates the signal input level on a meter, measure the level at both the input and output of the stage, keeping the tracer gain control at the same point. Dividing the second meter reading by the first will give the gain of the stage.

A vacuum tube voltmeter could be used in the same manner, but there is considerable chance of the vacuum

tube voltmeter reading stray voltages instead of the signal. For this reason, a tuned signal tracer, which can be made to select the proper signal, is the more desirable instrument.

▶ With either signal tracer, a signal generator is used as the signal source. It does not have to have a calibrated output voltage control as you depend on the signal tracer for the signal ratios. A dummy antenna should be used, however, when checking the gain of the preselector. If the set uses a loop antenna, just wind a four- or five-turn loop of wire and connect it to the output of the signal generator. Bring this loop near the set loop. You can't measure the preselector gain, but all other gain values can be obtained.

Gain Variations. The readings given by the manufacturer in his service information are average readings for the particular set type. These readings will not necessarily apply to any other receiver put out by the same manufacturer. When the gain data is given on the diagram, you can expect variations of as much as 20% in either direction. Variation in parts values can easily cause this much change.

If readings vary by more than 20%, then there is probably some defect in the set. If all readings are below normal, the set may be completely out of alignment, or the over-all sensitivity may be low.

More generally, a defect in a single circuit will be the cause of below-normal gain. In this case, you can expect most of the readings to be normal except in the one affected stage, where the reading will be very low.

▶ Don't be surprised at readings somewhat above normal, for better-than-average tubes, or coils with exceptionally high Q factors, will give increased gain. On the other hand, if the gain is very high and the re-

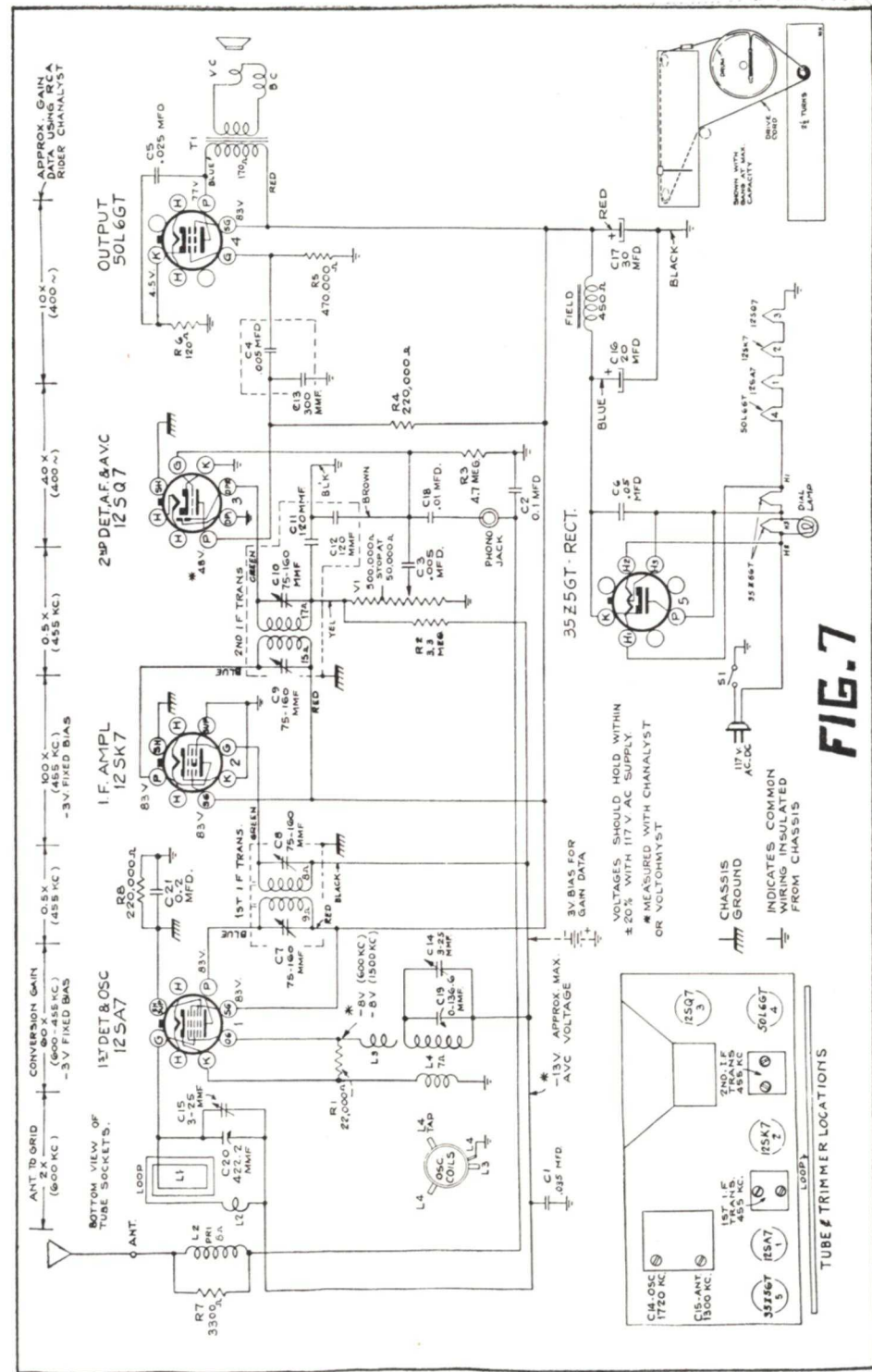

FIG. 7

ceiver has a tendency to go into oscillation, look for circuit faults causing regeneration.

Average Gain Values. When gain data on the receiver on which you are working is not available, you must use tables of average gain values. The gain to be expected from any stage depends on the type of receiver and on the number of stages.

The table in Fig. 8 gives the maximum and minimum values found by analyzing the information furnished by a number of manufacturers. It is quite possible that some receivers may have gain values above or below these averages, but in general you can expect most receivers to fall within these limits.

The possible variations here are quite wide. For example, the gain in the r.f. section from the antenna to the first grid in auto sets may be anywhere from 10 to 50. If you get a reading near the minimum value, you won't know whether this is natural for the receiver or whether the gain for this particular section should be near the maximum and is actually far below normal. You will have to be guided in cases like this by the results you obtain in the rest of your gain measurements and by the performance of the receiver.

If the receiver has less sensitivity than you would expect, yet all the readings are within the average limits, probably the loss of sensitivity is an over-all condition and the stage gains throughout are below normal. On the other hand, if the gain of some one stage is low but the other stages all give gain near the maximum, it would be logical to suspect the stage where the readings are low.

In general, allow a wider variation in the readings of the gain for the r.f., mixer, and detector stages than for the other stages.

GAIN DATA, AVERAGE VALUES

R. F. SECTIONS	Gain	
	Min.	Max.
Ant. to 1st grid.....	2	10
Ant. to 1st grid, auto sets..	10	50
R. F. Amp., supers, broadcast.....	10	40
R. F. Amp., t. r. f., broadcast.....	40	100
R. F. Amp., supers, short-wave.....	5	25
MIXER SECTION		
Converter grid to 1st i. f. grid (single i. f. stage)...	30	60
Converter grid to 1st i. f. grid (2-stage i. f. amp.)...	5	30
I. F. AMPLIFIER SECTION		
I. F. stage (single i. f.)....	40	180
I. F. stage (2-stage i. f.) (per stage).....	5	30
DETECTOR SECTION		
Biased det., 57, 6J7, 6C6, etc. (depends on % modulation).....	5	40
Grid leak det., square law..	5	50
Diode detectors (a loss) (depends upon % modulation).....	.2	.5
AUDIO AMPLIFIERS		
Triodes (low gain).....	5	14
Triodes (high gain).....	22	50
Pentodes.....	50	150
POWER OUTPUT TUBES		
Triodes.....	2	3
Pentodes and beam.....	6	20

FIG. 8. Average amounts of gain found in radio receivers.

Selectivity and Fidelity Measurements

We will treat selectivity and fidelity together, since the selectivity of a receiver has a bearing on its over-all fidelity.

Selectivity is a measure of the ability of a radio to select the desired signal and to reject others on adjacent channels. If the set is not selective, interference is certain to exist between stations on adjacent channels if the stations are powerful enough. On the other hand, if the set is too sharply selective, the higher side band frequencies of the desired channel will be cut out, and the fidelity of the receiver will be affected.

LABORATORY SELECTIVITY MEASUREMENTS

It is possible to indicate selectivity by plotting resonance curves which show the amount of amplification or gain at the resonant frequency and the gain at frequencies off resonance. However, since the gain of different receivers is not the same, it is difficult to compare receivers by using curves of this sort. As we are interested in how much *better* the response is at resonance compared with the response off resonance, it is standard practice to draw curves showing this ratio. Direct comparisons between receivers can be made from such curves.

To find the data needed to plot the curve, laboratory engineers use the same set-up used for sensitivity measurements in Fig. 2. Of course, the manner of using the equipment is somewhat different. The receiver dial and the signal generator are tuned to some frequency (say 600 kc.), and the microvolts input needed to give the standard output is determined. Let us suppose this input is 10 micro-

volts. Then, the receiver dial is left at the same setting but the signal generator dial is rotated 10 kc. away from resonance. The signal generator output is turned up until the receiver output meter indicates the same output power as before. Since the receiver is not tuned to the same frequency as the generator, a greater input is necessary to force the signal through the radio.

Suppose it now takes 5000 microvolts input to give the standard output. Dividing the microvolts input for the off-resonance frequency by the microvolts input at the resonant frequency gives us a ratio number (called the "signal ratio") that is a measure of selectivity. ($5000 \div 10 = 500$ in this case.) For comparison, engineers consider a set to have good selectivity if it takes 1000 times as much voltage to force a signal 10 kc. off-resonance through the radio as it does a signal to which the radio is tuned. Signal ratios of 100 to 1000 are considered fair, while a ratio of 10,000 represents excellent selectivity.

► To complete his data, the engineer continues in 10-kc. steps on each side of resonance, carrying out the readings over a range of 30 to 50 kc. on each side of resonance, and computing the signal ratio for each frequency. The ratio at each frequency is then plotted to form what is called a selectivity curve.

Fig. 9 shows several typical selectivity curves. The curve marked A-A shows fair selectivity. The broad dotted curve B-B is an example of poor selectivity, as the signal ratio for signals 10 kc. off resonance is less than 10. The curve C-C represents excellent selectivity. However, the extreme sharpness of this curve near the resonant frequency-setting indi-

cates that the fidelity of the receiver will be poor.

► The ideal curve for both good selectivity and good fidelity is shaped like the shaded area of Fig. 9. It has the selectivity of the curve C-C at the off-resonant frequencies, but has a broad flat "nose" around the resonant frequency, so that approximately equal amplification will be given the resonant frequency and its adjacent side-bands. Comparing this area with the other curves, you can see that the curve B-B indicates reasonably good fidelity, as the discrimination shown by this curve against frequencies 5 or 6 kilocycles away from resonance is not great. However, as you just learned, curve B-B also indicates very poor selectivity. Thus, selectivity and high fidelity are not apt to be found in the same receiver, unless the receiver uses some form of band-pass tuning to give a response like the relatively square-shaped ideal.

Usually, selectivity curves are taken at several frequencies over the band. Like sensitivity, selectivity varies at different frequencies. A typical curve showing the selectivity at 600 kilocycles compared to that at 1400 kilocycles is shown in Fig. 10.

SERVICE TESTS OF SELECTIVITY

As far as the serviceman is concerned, the only way in which selectivity measurements actually can be taken is by the laboratory method just described. Hence, only servicemen with standard type signal generators are able to check selectivity accurately.

However, extremely accurate selectivity measurements are rarely necessary. Anything which affects the selectivity of a receiver greatly will also affect the sensitivity and other

characteristics at the same time, and the trouble can be run down by investigating these other effects. If the receiver is badly out of alignment, the selectivity is reduced and the sensitivity will be very low. If the receiver is too sharply aligned, the fidelity will suffer and the sensitivity will be above normal. (The selectivity may also go up because of regeneration.) Of course, after you have quite a bit of practical experience, you will become adept at judging the selectivity. The practical serviceman tunes in some medium distant station, and then tunes away from the resonant point to determine how many dial degrees can be tuned through before the signal fades out. The "spread" on the dial is a rough indication of the selectivity of the set. If the station is tuned out by a small dial movement, the selectivity is usually good.

LABORATORY FIDELITY MEASUREMENTS

The fidelity of a receiver is a measure of its ability to reproduce exactly the modulation transmitted by the broadcast station. The ideal receiver would amplify all desired frequencies equally and would not introduce wave-distorting harmonics.

The audio amplifier is primarily responsible for the receiver fidelity characteristics, although the tuned circuits in the r.f. and i.f. stages may affect the high-frequency response. Theoretically, we need equal amplification of all frequencies from 30 cycles to perhaps 15,000 cycles to reproduce music with high fidelity. The response range of the average receiver is far more limited than this—a reasonably flat response from 150 cycles to 4000 or 5000 cycles is about all we will usually find.

To measure the over-all fidelity re-

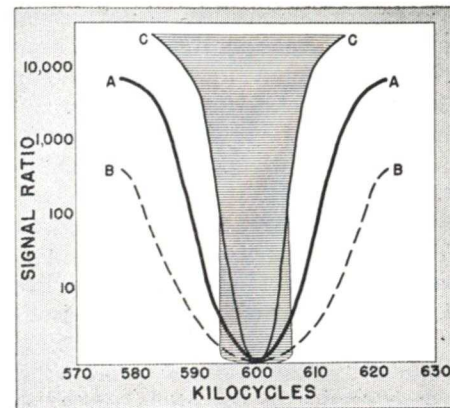

FIG. 9. Typical selectivity curves, showing excellent, fair, and poor selectivity. The shaded area shows the ideal, representing excellent selectivity without sideband cutting. The signal ratio is the ratio of the input off resonance to that at resonance, both giving the standard output.

sponse of the receiver, the same basic set-up as that shown in Fig. 2 is used. The only additional equipment needed is a variable audio oscillator, which is used to modulate the standard signal generator.

To get the response characteristic, the audio oscillator is first adjusted to produce a signal of 400 cycles, and the modulation percentage is adjusted to 30%. Then, with the receiver dial and the signal generator tuned to, say, 600 kilocycles, the signal generator output is adjusted to give some convenient output indicator reading. (This need not be the standard output value—just some convenient reading.)

This reading, obtained with a modulation frequency of 400 cycles, is our reference value. The audio signal generator is now varied to other audio frequencies, such as 30, 40, 50, 100, 1000, 3000, 5000, 7000, 10,000, 12,000 and 15,000 cycles. The exact frequencies at which the readings are taken do not greatly matter, as long as points over the complete range of the receiver are used.

At each of the new audio modula-

tion frequencies, the percentage of modulation is adjusted to 30%, but the signal generator output controls are left alone, as the same r.f. frequency is being used. The new output meter reading is noted at each of these frequencies; then the ratio between the actual output voltage at this new frequency and the output at 400 cycles is computed. A curve similar to Fig. 11 then is made up by plotting frequencies against the ratio of output at each frequency to the output at 400 cycles.

As shown by Fig. 11, the high frequency response depends on the selectivity. Another set of readings may be taken with the receiver and signal generator tuned to, say, 1400 kc. (Of course, the r.f. output must be adjusted to the same value as was used at 600 kc.)

The curves in Fig. 11 show the over-all fidelity of the receiver, excluding the loudspeaker and its response. Naturally, the loudspeaker and baffle assembly are going to

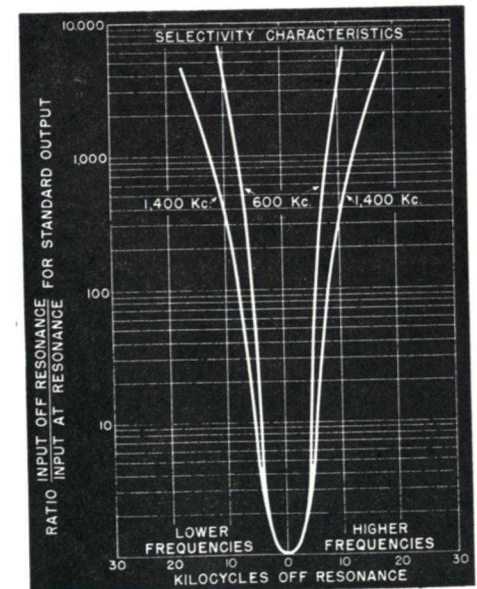
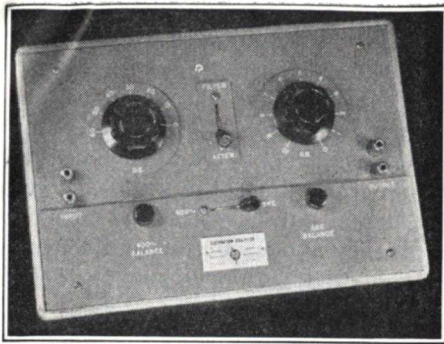

FIG. 10. How the selectivity varies at different points in the tuning band.



Courtesy Hewlett-Packard Co.

This distortion analyzer checks distortion at two frequencies, 400 cycles and 5000 cycles. It contains a tuned filter and an attenuator, so arranged that either one may be switched into use. A c.r.o. is used as an output indicator. The operating steps are: first, the tuned filter eliminates the fundamental frequency voltage, which leaves only the amplitude of the harmonic voltages indicated on the c.r.o. screen. Then the filter is switched out and the attenuator is used to reduce the c.r.o. indication to the same value as that obtained with the filter. The attenuator calibration then gives the harmonic distortion in db below the fundamental level. It is necessary that the audio source produce fundamentals of 400 cycles and 5000 cycles without any distortion.

affect the fidelity of the output to a great degree. However, we are now interested in getting the response of the receiver itself, and these curves give it.

Distortion Measurements. After plotting the frequency response curves, measurements are made to determine the harmonic distortion. Any of several laboratory procedures may be used for this. For example, the set-up shown in Fig. 12 has a distortion meter or wave analyzer at the output instead of an output meter. With this equipment, it is possible to determine the percentage of harmonics

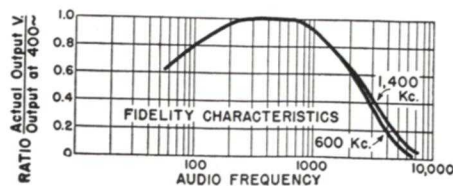
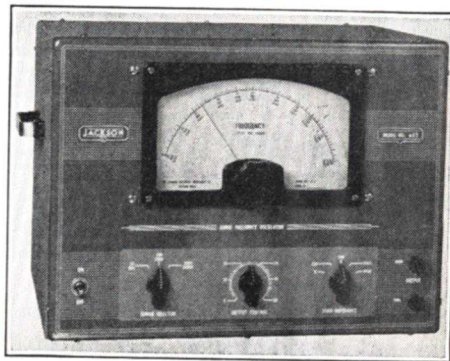

FIG. 11. Over-all fidelity curves.

introduced as a result of amplitude distortion in the amplifier.

The maximum undistorted power output can be determined by starting with a low input which is gradually increased until distortion is shown by the distortion meter or wave analyzer. An output meter is used with the distortion indicator, so that the power output level at which distortion first occurs can be measured.

Audio Amplifier Response. It is frequently desirable to check the characteristics of the audio amplifier alone. This is particularly true if



Courtesy Jackson

A typical audio signal generator designed for servicemen.

you are working on a public address or an electric phono system, either of which normally contains nothing but an audio amplifier.

The set-up is shown in Fig. 13. A variable audio signal generator is connected to the input of the audio amplifier and an output indicator is used across the dummy load resistance. Using a test frequency of either 400 or 1000 cycles, some reasonable output indication is obtained. Then, the audio signal generator is varied in steps over the range of audio frequencies, and output readings are made for each setting. The amplifier input must be adjusted (by the signal generator output controls) at each

test frequency so that it is the same as it was at 400 cycles. Unless the audio signal generator has an output indicator, a vacuum tube voltmeter is needed to check this.

We can again take the ratio between the output at other frequencies to that at the standard frequency, and plot another curve similar to that for the over-all response. The difference, of course, is that the response characteristic is that of the audio amplifier alone, and hence may vary widely from the over-all response, particularly at the higher frequencies.

► As an alternative method, a power output meter calibrated in decibels

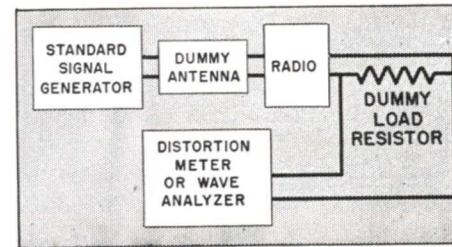

FIG. 12. Connections for determining distortion.

can be connected across the dummy load resistor and the output in db. can be read directly on the meter. If the output at, say, 1200 cycles is 10 db. and the output at 400 cycles is 8 db., we say the output at 1200 cycles is up 2 db. The curve prepared from such readings may be similar to that shown in Fig. 14A or 14B.

► If we get a flat curve like that shown in Fig. 14A, the amplifier is definitely a high fidelity type. This curve shows excellent response over the entire useful audio spectrum. However, it is quite likely that the amplifier response will be more like that shown in Fig. 14B, where the low frequencies drop off rapidly and there is some peak response around 4000 or 5000 cycles.

► Theoretically, the ideal amplifier

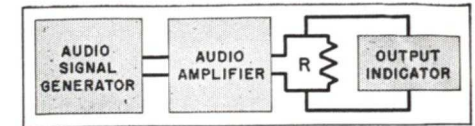

FIG. 13. How to get the response of an audio amplifier.

is one with an absolutely flat response. However, it may be necessary to "doctor" the response of the audio amplifier to compensate for deficiencies in the remainder of the receiver. A rising response characteristic or even a peak in the response may be desirable at the high frequencies to compensate for the side-band cutting which occurs in the r.f. stages. Thus, by over-emphasizing the high frequencies, we can make up for some of the loss in the r.f. amplifier and can improve the over-all response.

Similarly, a rise in response at the low frequency end of the band may be desired to compensate for a drop-off caused by the speaker or baffle characteristics.

► The relatively smooth curve normally obtained when checking an amplifier response may be utterly different if speaker responses are included. A typical curve in which speaker response is included is shown

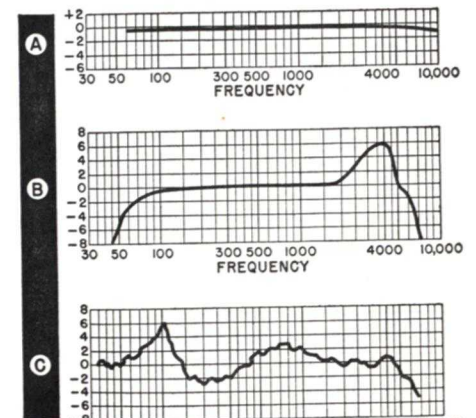
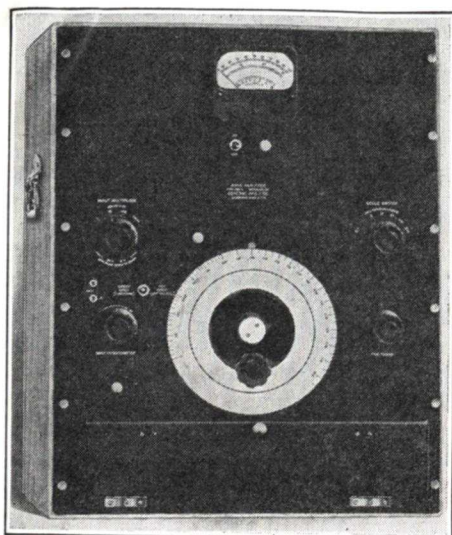

FIG. 14. Typical fidelity curves.



Courtesy General Radio Co.

A wave analyzer. A beat frequency is formed between the complex input wave and a built-in oscillator. This changes each audio frequency to a different i.f., as each frequency will form a different beat with the fixed oscillator. Thus the complex wave is spread over an r.f. band, and tuning circuits can be used to select each frequency component. An r.f. type v.t.v.m. then indicates the output at each frequency contained in the audio wave. Hence, the number and strength of each harmonic can be found.

in Fig. 14C. To make measurements for this kind of curve, a microphone and an amplifier are used, which have a combined response that is essentially flat. The microphone is mounted in front of the loudspeaker in a room with special acoustic properties.

The resonant characteristics of the loudspeaker cone-spider-voice coil assembly will cause numerous peaks and valleys in the characteristic curve. Hence, checking the over-all receiver response and the amplifier response merely gives us something with which we can make comparisons between similar amplifiers or receivers—it does not show the *actual out-*

put of the radio. Only an acoustical output response curve like that in Fig. 14C will give the actual sound output characteristics. Such a curve can be obtained only in laboratories equipped with the proper acoustical rooms and proper measuring equipment.

FIDELITY MEASUREMENTS WITH SERVICE EQUIPMENT

The measurements which can be made in the service shop will depend greatly on the equipment available. If the shop has a standard signal generator and variable audio oscillator, over-all response curves can be made in the manner just described. Similarly, with a variable audio oscillator, it is possible to obtain the response curve of an audio amplifier.

► As always, the serviceman is usually looking for some particular defect and will use short cuts. Rather than plot the audio amplifier response, it may be possible to just vary the audio signal generator over the band and watch for any sharp peaks or sudden dips in the signal voltage measured across the dummy load resistor.

► If the serviceman has a "musical ear", he can make a test by playing a record of known characteristics, and listening to the output of the audio amplifier. However, great care is necessary here: few people hear exactly alike, so the customer may object to a response which sounds good to the serviceman.

► As far as distortion is concerned, the methods of checking for distortion by using a c.r.o., given elsewhere in the Course, can be followed.

Miscellaneous Measurements

It is of course possible to measure any receiver characteristic one might imagine. There are a few of these which are of some interest, although servicemen rarely measure them. Let's run through some of these.

HUM MEASUREMENTS

In the laboratory, the residual hum level is measured by setting the radio volume control at maximum and short-circuiting the r.f. input so that no signals are picked up. The output voltage across the dummy load resistor is the fundamental hum frequency,

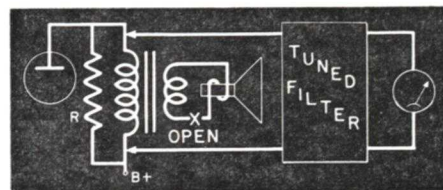

FIG. 15. A filter is necessary when measuring hum to eliminate noise components and to determine the amount of hum at each frequency. In practice, a serviceman would depend upon a listening test.

plus any harmonics of this frequency, plus any noise voltages which may be present. To eliminate noise, and also to make it possible to measure the frequency of the hum, a tuned filter may be used as shown in Fig. 15. This circuit is first tuned to 60 cycles and the amount of 60-cycle hum measured. Then the hum level is checked at 120, 180, and 240 cycles.

► If the hum is modulation hum, an unmodulated signal generator is connected to the input of the receiver and the hum output resulting is measured in a similar manner. Usually a high-sensitivity voltmeter must be used, as the hum voltage may be quite small even though it produces an objectionable amount of hum *sound* output.

► As a general rule, the serviceman just listens to the output of the receiver. If the hum is excessively loud, the serviceman is usually led right to the trouble by the frequency of the hum, which he can determine most easily by means of a c.r.o. or by having learned hum frequencies from listening to 60- and 120-cycle hum voltages. Modulation hum can be run down by moving the signal generator back through the r.f.-i.f. amplifier in the manner described in another lesson of your Course.

POWER CONSUMPTION

The manufacturer usually checks the power consumed by a radio receiver, since he generally gives this figure on the receiver nameplate. He probably will use a wattmeter in the manner shown in Fig. 16A.

If the serviceman has a wattmeter, he should make similar connections.

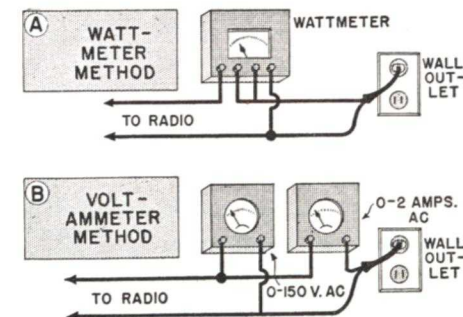

FIG. 16. Two methods of measuring the power consumed by a radio. The wattmeter is the more accurate.

If not, it is possible to use a voltmeter and ammeter by making the connections shown in Fig. 16B. The voltmeter-ammeter method does not indicate true power—multiplying their product by .8 will give a close approximation for the average a.c. radio using a power transformer.

Before using either method, it is a good idea to make sure the receiver is not in such a defective condition that it will damage the wattmeter or ammeter.

► Of course, any defects in the radio which cause a higher than normal current flow will be indicated by an increased power consumption. Thus, a leaky filter condenser or a short-circuited bypass condenser would result in an increased wattage consumption. However, the wattage test only indicates that trouble exists, without pointing out its location.

FREQUENCY SHIFT TESTS

Once in a while the oscillator frequency of a superheterodyne receiver will shift progressively as some component in the oscillator circuit is affected by the receiver heat. This will be indicated by the program becoming more and more distorted, with the distortion clearing up if the receiver is retuned. The oscillator drift causes the production of an incorrect i.f. frequency, so the wave is distorted because of side-band cutting. Usually the drift will be in a single direction, so that the receiver must be continually tuned to higher and higher frequencies, or to lower and lower frequencies, depending on the particular part causing the trouble and its temperature characteristics.

Of course, many receiver oscillators drift *slightly* during their warm-up period, but they settle down within a few minutes. This is the reason the receiver should be allowed to warm up for half an hour or so before it is aligned. For the same reason, the signal generator should be allowed to warm up if it is a.c. operated.

The fact that retuning is necessary from time to time to obtain maximum response or to clear up distortion indicates clearly that there is an

abnormal frequency shift. If you want to measure this, you can connect a signal generator to the input of the receiver, tune them to resonance with each other, and allow both to operate for a period of time. Then, retune the signal generator for a maximum output indication. The difference in frequency between the original setting and the new setting indicates the amount of drift in the receiver for that particular period of time, provided the signal generator is itself free from drift.

DEAD SPOTS

The laboratory and service tests for dead spots are identical. The receiver dial and signal generator dial are rotated in step over the entire frequency range of the receiver. For example, if we wish to check the broadcast band, both the generator and the receiver dial should first be set to 550 kilocycles, then to 560 kilocycles, and so on at 10 or 20 kilocycle intervals up to 1500 kilocycles. At each setting we should listen to make sure the output is normal. A skillful operator can turn the generator dial with his left hand and the receiver dial with his right, keeping the two in step, and get a continuous check throughout the band.

Naturally, a dead spot would be indicated by a lack of reception or by a sharp drop in output over some portion of the tuning range of the receiver.

IMAGE REJECTION

Suppose a receiver dial is set to receive a 1500-kc. signal and that the i.f. of the set is 460 kc. This means the receiver oscillator will be working at a frequency of 1500 plus 460 or 1960 kc. Now, if a signal from a station at 2420 kilocycles is strong enough to get through the preselector, it also will produce the right i.f. value,

since 2420 minus 1960 is 460 kc. Thus, it is possible for the proper i.f. value to be produced by signals either above or below the oscillator frequency. The interfering signal (from the station the receiver is not tuned to) is called an image, and is twice the i.f. value above the desired signal frequency.

The ability of the receiver to reject image interference is determined by the following procedure. First, the signal generator is set to the frequency to which the receiver is tuned, and the input necessary to give standard output is determined. Then, with the receiver dial left at this point, the signal generator is tuned to the image frequency. The output from the signal generator is adjusted again to produce standard output. Dividing the signal input at the image setting by the signal input at the receiver dial setting gives the image rejection ratio. A ratio of 100 to 1 or greater is desired. A ratio below this value indicates poor receiver design or a receiver badly out of alignment. However, it is possible for image interference to exist even with a satisfactory image ratio if a very powerful station happens to be at the image frequency of a desired station. In this case, a change in the i.f. value of the receiver, or the use of a wave trap tuned to the interfering station would be an effective cure.

TESTING FOR NOISE

In the laboratory, the receiver is tested for noise output by a method similar to that used for the hum voltage check. The receiver is placed in a shielded room and the power lines

leading into the room are thoroughly filtered, so that whatever noise is heard must come from the radio itself.

To distinguish between noise and hum, tuned filters may be used between the receiver and output indicator, tuned to *reject* the hum frequencies of 60, 120, and 240 cycles. Any remaining output from the receiver must then consist of noise components.

In the service shop, a shielded cage to prevent direct noise pick-up by the receiver is seldom available. Usually, the serviceman depends on a power line filter to remove any noise that may be coming in this way, and then compares the noise level heard on a suspected radio with that normally heard in the shop on other similar receivers. It is well to be cautious about judging the noise when no signals are tuned in, however, as the more sensitive the receiver, the greater the amount of noise pick-up by the circuit wiring, and also the greater the tube noise level. In fact, you probably will have to explain to many customers why their large sensitive receiver is so much more noisy than some inexpensive midget set they may have or may have heard.

Actually, of course, the amount of noise heard between the stations is no criterion of the performance of the receiver when it is tuned to a station. It is quite possible that the reduction in sensitivity brought about by the normal action of the a.v.c. circuit may cut out all the background noise. The important factor is the amount of noise heard when tuned to a station giving normal reception in your locality.

Receiver and Part Revitalization

Although revitalization is concerned with any of the receiver characteristics which may be below normal, most ordinary radio troubles can be located and cured by the usual servicing methods. Then, replacing any defective tubes, cleaning the chassis, and perhaps realigning the receiver will complete the service job.

However, there will be cases where the receiver has "lost its pep," so it has below-normal sensitivity, or has hum, noise or distortion levels somewhat above normal, but not high enough to present a real defect. These conditions may or may not exist together. The causes and cures of most of these have been given elsewhere in your Course, so now let's concentrate on those troubles causing below-normal sensitivity.

▶ As you know, radio parts do wear out through normal use. Tubes age, lose emission, and therefore reduce the stage gain. Paper condensers develop leakage because of dielectric fatigue and manufacturing imperfections. Electrolytic condensers dry out, develop high power factors, or become leaky. Speaker cones dry out, voice coil forms warp, and speakers using permanent magnets lose their magnetism.

In addition, misuse or accidents will cause trouble. For example, a receiver may be left near an open window during a rain-storm and the r.f. coils may absorb moisture, resulting in a decrease in the Q factor.

▶ Receivers designed for use in the tropics are thoroughly moisture-proofed. However, the average set is not so treated, and if it is used at the seashore or is left in a damp basement or damp recreation room, moisture is likely to get into the coils, transformers, and wire insulation,

lowering the over-all sensitivity. In addition, acid fumes from coal burning furnaces or from industrial plants can set up corrosion and cause leakage paths between wires. A heavy coating of grease (which is sometimes conductive) will be found on exposed parts and chassis of receivers used in kitchens. And, of course, a receiver which has been through a flood or has been drenched by a fire hose will be well water-soaked.

DISASTER DAMAGE

Let us first see what to do to a receiver which has been damaged by a fire or a flood, as certain steps are necessary even to restore such a receiver to the point where ordinary procedures will be effective.

When a receiver is brought to you and obviously shows signs of disaster damage, the first thing to do is to remove the chassis and speaker from the cabinet. Remove the tubes and clean off the accumulation of mud or other debris. Some servicemen figure that since the receiver has already been water saturated, a little more water won't hurt, so they use a stream of warm water from a hose to clean the chassis. However, if possible, clean the chassis by using a dry cloth. If there is oil or grease on the chassis, carbon tetrachloride or Varsol, both good solvents and non-inflammable, may be used for cleaning. A rag or brush dipped in the solvent can be used to remove grease and other chassis dirt. (This work is best done outside, or in a well ventilated room, since the fumes from the cleaning solvent make some people ill.)

When the chassis has been cleaned, you must find a way of removing the accumulated moisture. A damp chassis put in a warm, dry place will not

become completely dry. Excess water will evaporate, but the moisture-laden air will be trapped in parts and under shield cans. To remove moisture from the chassis completely, a stream of dry, heated air should flow over the chassis and around and through moisture-laden parts. The moisture will be carried away by this stream of air.

For occasional jobs, a small electric fan and an electric heater can be directed against the chassis as shown in Fig. 17. The heater vaporizes the moisture and the fan drives the moisture-laden air away from the chassis. It is necessary to change the chassis position several times so that all parts will be dried equally.

▶ In larger shops, where work of this sort may be done more often, an outfit like the one shown in Fig. 18 may be used. The asbestos-lined box

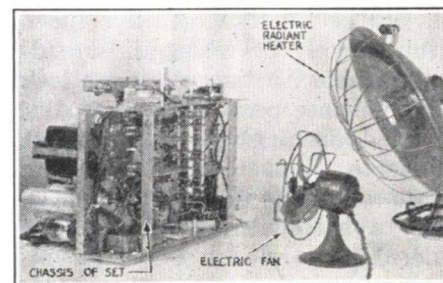

FIG. 17. How to use a fan and an electric heater to dry out a radio chassis.

sheet metal, or might be a portable cooking oven. After placing a chassis on the grid shelf, close the box tightly, and start the heater. After a few minutes, turn on the fan so it will drive the moisture-laden air up the stove-pipe exhaust away from the radio. Watch the temperature with a thermometer which has its bulb in the oven and its reading stem exposed to the outside. Keep the temperature at about 130° F. This tempera-

ture is sufficient to vaporize moisture but will not damage the receiver parts or cause undue melting of the wax or pitch used in sealed parts. Two or three hours in the oven should be long enough to dry out the average chassis.

▶ Once the chassis is perfectly dry, blow out all dirt and dust with a small hand bellows, a bicycle pump,

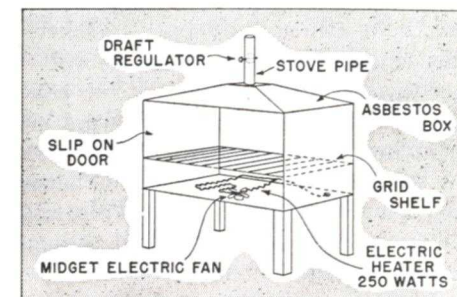

FIG. 18. A drying oven.

or a vacuum cleaner blower attachment. Clean all surfaces with a dry cloth. Use pipe cleaners (available at any tobacco store) to remove all dirt and dust from between the plates of the variable condensers.

Operating Precautions. Before trying the receiver out, first check for leakage within the power supply, by measuring across the B supply terminals with an ohmmeter. Place the ohmmeter test probes across either the input or output filter condenser leads—whichever are more accessible. The diagram will show if a bleeder resistor is used. If there is no bleeder, the leakage resistance should be that of the filter condensers, provided you observe proper ohmmeter polarity. If the resistance is abnormally low, disconnect the condensers and check them individually. Make replacements if you find the condensers are at fault; otherwise, run the trouble down to the defective part.

If the B supply resistance is normal, replace all the tubes *except the*

rectifier, and turn the set on. The tube filaments will place a partial load on the power transformer. (You cannot make this check on a.c.-d.c. receivers, since removing the rectifier tube breaks the filament circuit. However, there is no power transformer to worry about in such sets, so you can plug in the receiver directly.)

If the transformer shows no signs of overheating after half an hour, put the rectifier tube in its socket. This will supply tube electrode voltages throughout the chassis. You can now treat the receiver as if it were in for an ordinary repair job. Of course, the speaker cone will have been ruined, and will have to be replaced, and you will probably find other parts similarly damaged.

► After the receiver is restored to operating condition, very likely you will find it desirable to improve its performance with the regular revitalization procedures we will now give.

ORDINARY REVITALIZATION

The following procedures will apply equally to receivers which have been damaged (by flood or fire) and to those receivers which have lost sensitivity with age. Normally, even if nothing else happens to a receiver, its performance will drop off gradually over a period of years. The distortion and hum levels will increase, the sensitivity will decrease, and the set will not separate stations as well as it did when new. Many a set owner, when he finally becomes aware that his radio has reached such a condition, thinks nothing can be done for it and buys another. Yet it is often possible to restore such a receiver nearly to its original condition. Let us see, first, what can be done to improve its sensitivity.

A loss of sensitivity is caused by loss of stage gain. The gain may be

reduced by improper alignment, tube defects, changes in the value of the load into which the tube works, open bypass condensers, or changes in operating voltage. In addition, various defects may have reduced the Q or step-up obtained in the resonant circuits; in fact, this last is the most common reason for loss of sensitivity.

The first step in revitalization is to clean the receiver thoroughly. **DON'T USE WATER!** Wipe the receiver carefully with a *dry* cloth, blowing out the dust with a hand bellows or bicycle pump (or use compressed air). Clean the tuning condenser gang carefully with a pipe cleaner. If there is a heavy coating of grease or oil on the receiver, remove it with a solvent such as carbon tetrachloride or Varsol (not water).

Then, try realigning the receiver. Notice the action of the trimmers, particularly if the receiver sensitivity is not restored to normal. Frequently, you will be led to a defective tuned circuit directly by a sluggish, broad-tuning trimmer action, or even a lack of a resonance peak.

Tuned Circuit Overhaul. The next step is to eliminate resistance from the tuned circuits to improve their Q. Apply a hot soldering iron to each soldered joint in each tuned circuit, heating the joints until the solder runs. Any corrosion which has formed, or any cold-soldered joints, will be eliminated and the resistance in the tuned circuits lowered. Use a solvent such as carbon tetrachloride to clean the spring wipers which connect the rotors of the condenser gang to the frame. Also, bend the wipers to give a better wiping contact.

► If the stators of a condenser gang section are held in place by bolts on each end (they are soldered in place in recent receivers), the connection to each stator is made through these bolts. Sometimes corrosion on the

bolts increases the resistance of the circuit. Simply loosening and tightening these bolts, one at a time, will remove the corrosive deposit and reduce the connection resistance to its normal level.

► Besides the series resistance, leakage across the coil forms or across the tuning condenser gang also will lower the tuned circuit Q. Carefully clean the dust from between the plates of the tuning condenser gang. In addition, clean all of the insulating strips used in the condenser assembly.

Lowered coil Q is often caused by moisture absorbed in the coil form. You should wipe the coil form carefully to remove any surface moisture, then bake out the receiver by one of the methods shown in Figs. 17 and 18 to drive off absorbed moisture. (Incidentally, the speaker cone should not be baked out, for excessive drying of the cone will make it brittle. If anything is the matter with the speaker cone, it is best to replace it.)

Circuit Troubles. After you have improved operation of the tuned circuits, check over the operating conditions. The load into which an r.f. tube works is very frequently governed by a tuned circuit Q, so clearing up tuned circuit defects may cause normal operation. Of course, you should realign the radio after having worked over the tuned circuits. Should the sensitivity still be below normal, check the operating voltages and correct any defects so that proper voltages will be obtained.

A loss of speaker magnetism will lower the output of the receiver considerably, so if p.m. or magnetic speakers are used, it may be desirable to have them overhauled by the factory and remagnetized, or else replace the speaker.

► After you have followed all these procedures, you may be able to get a

little more sensitivity by "selecting" the tubes. Many servicemen overlook the fact that tubes of the same type do not all have the same gain. This is caused by small differences in the mutual conductance of the tubes, which will not show up on most tube testers. To select the tubes which will produce the maximum performance from a particular receiver, feed a signal from a signal generator into the set and connect an output meter so that it will measure the set output. Tune the set to resonance, and adjust the input to a value which produces some easily remembered output meter reading. Now try several different tubes of the proper type in each socket, and make a note of the output reading each tube produces. (Don't change the tuning or the volume control settings.) Leave in the tubes giving the highest output.

Further Overhaul Steps. If the receiver is being completely overhauled, check all fixed condensers for leakage and for capacity with a condenser analyzer. In addition, check the resistors with an ohmmeter and replace any that are more than 20% off from their rated values.

► Check all controls. If the dial cord is frayed, install a new one. Work powdered rosin into the cord if it slips. Should the receiver be noisy when you pull or push on the tuning knob, apply Grafoline (a mixture of vaseline and graphite) to all metal parts in the dial tuning mechanism. (Don't get any on the dial cord.) Clean the wave band switch contacts, and replace the volume control if it has a tendency to be noisy.

MOISTURE-PROOFING RECEIVERS

When a receiver from a seashore cottage or pleasure boat has been re-

vitalized, the improvement will only be temporary unless steps are taken to prevent recurrence of the trouble. The procedure necessary for moisture proofing takes some time, so the process is rather costly. Be sure to explain this to the customer and get his O.K. before considering these steps. Here is what can be done about the parts most frequently affected.

R.F. Coils. The r.f. and i.f. transformers and coils in many receivers are untreated. Such coils and their coil forms are bound to collect moisture sooner or later, and their exposed terminal lugs are subject to corrosion.

It is frequently possible to buy a treated set of coils for the receiver. These coils will have been wax-dipped by the manufacturer in such a manner that they are less likely to absorb moisture.

If it is impossible to obtain treated replacement coils, the original coils can be thoroughly baked out, then treated by dipping them in melted "ceresin" wax, or by "painting" the windings, terminal leads, and connections with a thin coat of a moisture-proof insulating coil "dope." Preferably use a dope compound having a Polystyrene base, such as Amphenol 912 or Carron HQ-711. The coils must be thoroughly dried before being given such a treatment; if necessary, they can be removed and baked individually. Individual baking is best if the coil is covered by a shield can, since all the moisture may not be driven out by heat treating the entire chassis.

The coil dope just mentioned is a clear, transparent liquid which dries rapidly in air to form a hard, permanent surface. Ordinary insulating varnishes are not suitable for treating r.f. coils because the varnishes themselves have losses.

► Very frequently, the r.f. leads between the tuning coils and condensers

are ordinary cotton-covered wire. Replacing these leads with solid bare wire where possible, or with wire covered by varnished insulation or rubber, will frequently help to reduce trouble caused by moisture collecting in the tuned circuit.

Similarly, any shielded r.f. leads quite likely will have developed leakage between the wire and the shield. Replacing defective leads will pep up a receiver a great amount.

Many of these steps, individually, will not seem to make any difference in the operation of the receiver. Collectively, however, they will prove effective.

Most servicemen stop after carrying out the steps just given, since treating the tuned circuit coils and leads will be sufficient in most cases. However, several additional steps may be taken if the set requires them. Some suggestions follow.

Variable Condensers. Trouble with the wiping contacts between the shaft and frame is liable to occur again. The only way of eliminating this trouble permanently is to use pigtail leads. These leads are flexible wire, one end of which is soldered to the rotor shaft while the other end is soldered to the condenser frame or chassis. There should be a separate pigtail lead at each rotor element of the condenser; that is, a three-section condenser should have three pigtails.

It is sometimes impossible to solder pigtails to the rotor shaft. In such cases, the shaft may be drilled, a screw run through it, and the lead connected to the shaft under the screw head. Be sure the pigtail lead is long enough for the condenser to be rotated throughout its range without breaking the lead.

Any trimmer or padder condensers associated with the tuning condenser gang must be carefully cleaned and should be checked for leakage.

Cracked mica means the trimmer must be replaced.

Fixed Condensers. Mica condensers molded in bakelite are usually moisture proof. However, the bakelite may crack, permitting some moisture trouble. If you find a cracked condenser, replace it with a new one, and treat the new condenser with coil dope to seal any cracks which may be in it.

Dry electrolytic condensers are preferable to the wet types where moisture trouble exists. The kinds sealed in metal containers should be used. (To prevent corrosion of the container itself, many high-grade dry electrolytic condensers are sealed in a metal container, which is itself encased in a wax-covered cardboard tube or box.)

Paper condensers should be of the type sealed in a moisture-proof wax cylinder.

Fixed Resistors. Resistance wire is very apt to be corroded by moist, salt air. Corrosion is particularly likely to develop where the resistance wire of a resistor joins the terminals. For this reason, resistors wound with bare resistance wire, or which have a portion of the winding left exposed for adjustment of resistance value by a slider, should never be used. It is best to use an adjustable resistor temporarily to find the right value, then replace it with a vitreous enameled resistor which has the correct value. If the original resistor was used as a voltage divider, then two resistors can be used to replace it.

A.F. Transformers. An a.f. transformer which is mounted in a metal case filled with sealing compound

will usually be relatively free from moisture trouble. However, any open transformer (or cased unit which does not contain a sealing compound) may easily be affected by moisture. Replace any defective units of this type (using a sealed transformer if possible). An open transformer can be coated with coil dope, but this is not always successful in preventing moisture troubles.

Tube and Socket Contacts. Tube sockets frequently fail, usually breaking down between the plate contacts and adjacent terminals. Such breakdowns are particularly common in wafer-type sockets, especially those used for rectifier or power output tubes. A defective socket should be replaced with one of a better type, such as a molded unit.

Corrosion is practically certain to cause poor contact between the tube prongs and the socket contacts from time to time. Cleaning the tube prongs with sandpaper and working the tube in and out of the socket a few times will usually clear up this trouble.

Dry Batteries. A modern dry battery is housed in a waxed container which usually does not cause much trouble as long as it can be kept relatively dry. However, sometimes leakage will develop through this case if it is placed where moisture can collect. Batteries should be given a thin coat of paraffin or beeswax, preferably the latter, to prevent this leakage. Don't try to separate batteries by pieces of ordinary cardboard or paper; such material absorbs moisture readily and will make matters even worse.

Tube Testers

Tubes are responsible for a great many radio troubles. As a result, it is necessary to have some means of checking the condition of tubes.

Tube manufacturers have very elaborate testing apparatus. They can measure the mutual conductance, amplification factor, plate resistance, tube element capacity, and any other tube characteristic at will. Such testing apparatus might well fill a good sized room and cost thousands of dollars

Naturally, any such equipment is out of the question for servicemen. Therefore, simplified, portable testers were developed. These testers give an indication of the tube value or quality by checking one or two important characteristics of the tube, instead of all its characteristics.

Before we can determine whether or not a tube is good by measuring one of its characteristics, we must decide what variations in that characteristic are acceptable. As you already know, tube charts give average tube values. Manufacturers permit variations in many of these characteristics of 20 to 30% and frequently congratulate themselves upon getting even this close to the average. Thus, the fact that tubes have the same type number does not mean that they have exactly identical characteristics even when new.

Of course, radio circuits are designed for tubes with average characteristics. An exceptionally "peppy" tube will increase the sensitivity of a stage and may even cause oscillation if the circuit is relatively unstable. On the other hand, a tube with lower-than-normal characteristics may reduce the sensitivity.

► A tube may be considered unsatisfactory for any reason which causes

abnormal performance. We may list these reasons as follows:

1. Open element (usually the filament).
2. Incorrect emission.
3. Incorrect mutual conductance.
4. Gas.
5. Loose elements.
6. Shorted elements.
7. Leakage between elements.
8. Incorrect power output.

Of these, mutual conductance, power output and emission are the "quality" factors, so tube testers check one of these. In addition, most tube testers will check for shorts and leakages, and a few will check for other defects. Tube testers thus provide a means of quickly weeding out the tubes with major defects, leaving others to be found by their symptoms. Of course, it is always possible to try another tube in place of a suspected one, and this is often the only test which can be relied on completely.

MUTUAL CONDUCTANCE TESTERS

The mutual conductance is recognized as a "figure of merit" of a tube. A measurement of the mutual conductance determines the ability of

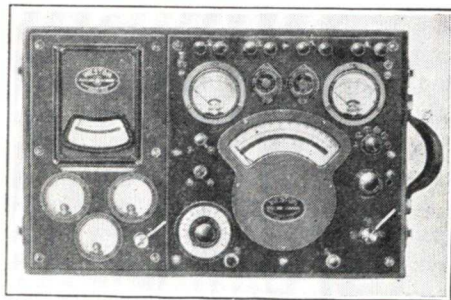

Courtesy Weston

One of the early tube testers designed for checking for shorts, amplification factor, plate resistance, mutual conductance and gas. This tester was too elaborate for servicemen, but was a forerunner of the types used by tube manufacturers.

the grid to control the plate current of a tube and takes into consideration the amplification factor and plate resistance of that tube. It was natural, therefore, for the earlier tube testers to measure mutual conductance.

The circuit of a basic tester of this type is shown in Fig. 19. To use this tester, we first apply the proper filament voltage, set switch *S* to position 1 so that battery *E*₁ furnishes the correct grid bias, apply the proper plate

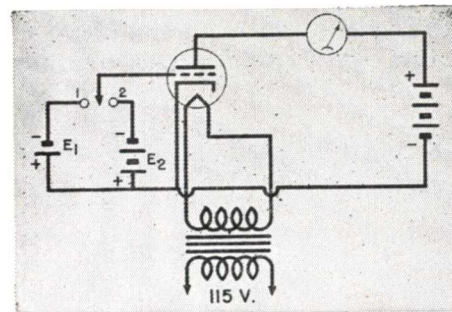

FIG. 19. The basic diagram of a grid shift or mutual conductance tester.

voltage, and read the resulting plate current.

We then throw switch *S* to position 2, which provides a different bias. This results in a new plate current. By dividing the difference in the plate current readings by the difference in grid bias voltage, we get a measure of mutual conductance. (In other words, for a constant plate voltage, dividing the change in plate current by the change in grid bias gives us the mutual conductance.) If the plate current change is in milliamperes, multiplying the result by 1000 will give the mutual conductance in micromhos.

This tester was called a grid shift tester because of the method of changing the bias. It was rather inconvenient to use, since two readings



Courtesy Weston

One of the first grid shift or mutual conductance testers designed for servicemen.

and some figuring were necessary before the mutual conductance could be found. As a result, tube testers were soon developed which eliminated much of this inconvenience; they had elaborate circuits to balance out the first meter reading, and had the meter arranged so that it indicated the difference in current directly with its second reading. This arrangement allowed the meter dial to be calibrated in mutual conductance, so that no figuring was required.

► However, using a d.c. voltage

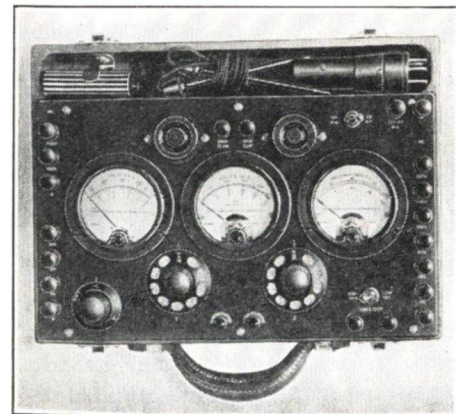

Courtesy Weston

Many of the early set analyzers had a built-in grid shift test. Readings were only relative, as the analyzer depended on the radio for voltages, but tubes could be compared this way.

change on the grid does not indicate the dynamic or operating characteristics of the tube. For this reason, as soon as a.c. power supplies became common, a dynamic mutual conductance tester was developed in which an a.c. voltage was applied to the grid as shown in Fig. 20.

This circuit has the advantage that, when the a.c. grid voltage is adjusted to exactly 1 volt, the mutual conductance (in micromhos) of the tube is equal to the resulting plate current reading in milliamperes, multiplied by 1000. Because the plate current wave is distorted, it is desirable to have a meter which will indicate the effective or r.m.s. value of an a.c. wave, so a dynamometer is used. In Fig. 20, one coil of the dynamometer is connected to the transformer. This makes the meter read *only* the a.c. plate current, ignoring the initial d.c. current altogether, as only a.c. will produce an adding field and give a deflection.

Advantages and Disadvantages.

Mutual conductance testers were fine in the early days of radio, when there were but a few tube types. The first models all required that normal operating voltages be applied to the tubes. As new tube types came out, an increasingly wide variety of filament, grid, and plate voltages had to be supplied. Then, screen grid, pentode, and other multi-element tubes came out, which hopelessly complicated the power supply situation.

► At this time, manufacturers decided that it was unnecessary to determine the *actual* mutual conductance, as long as some comparative reading could be obtained. To get a basis for such readings, arbitrarily determined voltages were applied to the grid and plate elements of tubes known to be in good condition, and the mutual conductance of each was measured under these conditions.

The resulting readings were compiled into a chart which then became a standard for tubes measured under the same conditions. In other words, all one had to do to determine whether any particular tube was satisfactory was to compare the readings with those on the chart for that particular tube tester. If the readings obtained came within normal tolerance limits of those given on the chart for that type of tube, then the tube being tested was good.

The chart values, of course, were not true mutual conductance values, but they were just as useful for tube testing. Further, this method of using

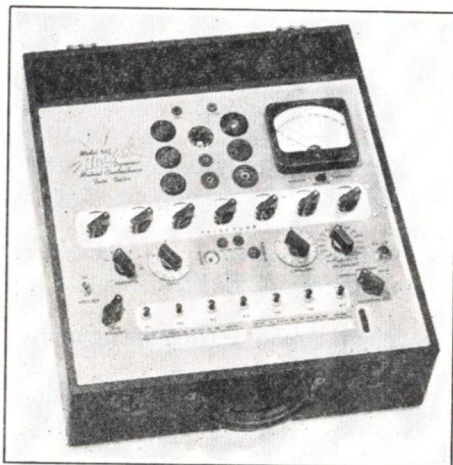

Courtesy Hickok Elec. Inst. Co.

A modern dynamic mutual conductance tube tester. Through the use of an elaborate switching arrangement, mutual conductance values may be read, or by switching, the results may be read on an "English" scale.

arbitrary voltages on tube elements allowed some elements to be connected together. In a screen grid tube, for example, the screen grid could be tied directly to the plate as long as the applied voltage was kept within safe limits. This vastly simplified the power pack requirements.

Finally, since the chart readings were not the true mutual conductance values, it was possible to go a step

further. The chart itself could be eliminated by proper selection of voltages, so that the so-called "English reading" dial scale could be used on the tube tester. This scale was divided into sections marked BAD—QUESTIONABLE—GOOD. When the controls were properly set, the tube plate current would cause an indication in one of these sections and so show the condition of the tube at once. Such a scale is far easier to read; it can be marked to take care of tolerance limits; and—most important of all—the customer can understand the readings. In fact, this scale has so many advantages that it is now standard on practically all tube testers.

The first testers of this improved type had several sockets, each of which was wired to make the correct connections to a particular group of tube types. However, the great number of tubes developed soon made this method unsatisfactory because too many sockets were required. Finally, a design was evolved which had one socket for each type of tube base. Connections between the tube elements and to the power supply were made by a rather elaborate switching arrangement. Even at best, this was a complicated type of tube tester.

POWER OUTPUT TESTER

While more modern equipment has largely superseded the mutual conductance tester, some models of it are still being sold and used. The tester is entirely satisfactory for tubes intended for voltage amplification. It falls down somewhat on testing power tubes, however, and does not duplicate operating conditions for the ordinary amplifier tube, because it has no load in the plate circuit.

The tester shown in Fig. 21 is known as a power output tester. The

chief difference between it and the mutual conductance tester lies in the fact that the tube operates into its rated load, which is adjusted by varying R_L . The mutual conductance can be found under conditions more closely resembling actual operation, and the output power can be determined. (The power output equals

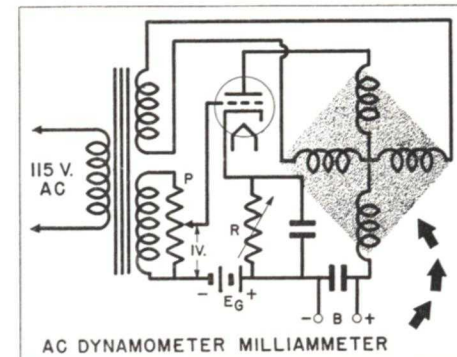

FIG. 20. A dynamic mutual conductance tester, using an a.c. voltage on the grid.

the load resistance value multiplied by the square of the a.c. plate current.) Instead of calculating these values, the voltages are arranged so the meter reads on an English scale.

The power output tester gives a more accurate test under reduced voltage conditions than does the mutual conductance tester. Several testers of this basic type are now being made.

EMISSION TUBE TESTERS

Both the mutual conductance and power output testers run into trouble in testing diode tubes. Since a diode has no grid, it has no mutual conductance. Therefore, an emission test is the only one which these testers can make on a diode tube. This test is made by applying a chosen voltage to the tube and measuring the resulting plate current. This will give some idea of the ability of the cathode to

function under normal conditions and deliver normal emission.

► Since emission tests are all that could be made on diodes, it is natural to consider checking just the emission of all tubes, assuming that if the cathode emission is normal, the mutual conductance and other factors are probably acceptable. This led to the development of the emission type tester, in which all tubes are converted to diodes and the plate current is measured. The basic circuit for a tester of this type is shown in Fig. 22.

As you can see, the grid elements are all tied to the plate of the tube, and a fixed voltage is applied between the cathode and the elements which are tied together. The fixed low voltage reduces the danger of excessive current flow. However, since a power



Another modern emission tester. This is the NRI Professional model. The lid is detached when the instrument is used on the workbench. The chart containing operating instructions is carried in the lid when the instrument is used as a portable tube tester.



Courtesy Triplet Elec. Inst. Co.

A late type emission tester. Toggle switches are used to make the "shorts" tests, and to select the proper elements for the emission test. There is a built-in roll chart that is set to give a listing of the switch settings for the tube type. This model is also a multimeter.

tube will naturally pass far more current than a voltage amplifier, some means of changing the meter range must be used. In this particular model, resistor R_2 acts as a shunt on the meter and resistor R_1 acts as a

series resistance. These two resistor units are usually ganged together and operated by a single control. When the resistors are adjusted by the control to the proper value for the type of tube being tested, the plate current reading on the meter M will indicate the worth of the tube on the BAD—QUESTIONABLE—GOOD scale.

Advantages and Disadvantages.

Today, the emission tester is the most common of the tube tester types. It is the simplest to construct, the easiest to operate, and the lowest in cost. The circuit arrangement makes it easy to test new tube types as they are brought out.

Admittedly, it is not the best tube tester, for a tube may test good on it and then prove faulty when installed in a radio circuit. However, in general, any tube rejected by this tester is definitely bad.

Since only the emission is measured, not the ability of the tube grid to control the plate current, the mu-

tual conductance of the tube may be below normal without this fact being disclosed by the emission tester. However, this tester will pick out most of the defective tubes, and a trial in the receiver will quickly determine whether a tube which tests GOOD is actually in the best operating condition.

► While there are many different makes of emission testers, all of them have much the same features. Any one you buy will have a tapped filament winding, so that the proper filament voltage can be supplied to any tube type. It will have a series of toggle switches, push buttons, or a selector switch to connect all elements except the cathode (and filament) to the plate, and will have some means of varying the resistors R_1 and R_2 together. Incidentally, the latter control is commonly marked the "load" control.

OTHER TUBE TESTS

Today, service-type tube testers fall into one of the foregoing basic

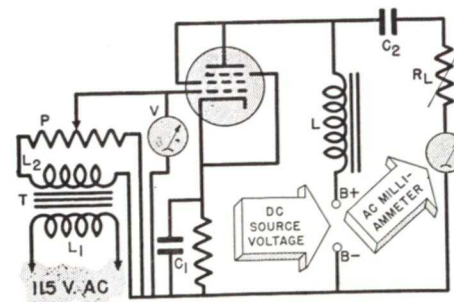

FIG. 21. The power output tester measures the power fed into the rated tube load.

types, testing quality by measuring the mutual conductance, the power output, or the emission. In addition to the foregoing "quality" tests, many of these tube testers can make additional tests. Let's see what some of these tests are.

Shorts and Leakages. Practically all modern tube testers can check a tube for short circuits. Most of them also test for leakage between the elements as well. In fact, it is necessary to test a tube for shorts and leakage before making a quality test; if such tests are not made, the tube tester may be damaged by excessive current flow.

A basic short checker is shown in Fig. 23. In the positions shown, the switches tie all of the elements to-

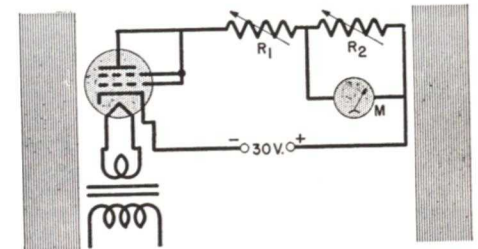

FIG. 22. The basic emission tester circuit.

gether. One side of the filament circuit is then connected to the power line, while the other side of the power line is connected through a neon lamp and resistor to additional switch contacts.

After the filament voltage is adjusted to the normal value, the switches are thrown one at a time. Each switch is returned to the position shown in Fig. 23 before the next is thrown. Each throw of a switch to the left connects one individual element to the resistor-neon lamp assembly, and thus forms a circuit in which the power line voltage is connected between this one element and all others through the lamp and resistor. If there is any short or leakage between this element and any of the others, the lamp will glow. The condenser C prevents rectified current flow, so the neon lamp will not be lighted by currents resulting from



Courtesy Weston

This modern emission tester checks batteries as well as tubes, the meter being used as a volt-meter for this purpose. You will find that many tube testers are "combination" testers like this.

emission and the rectifying action of the tube. The charging of the condenser may result in a momentary flash (but no steady glow) as the switches are closed.

The switches can be individual switches, thrown one at a time, or they can be steps on a selector switch that is rotated through the short-testing positions. This test always precedes the regular tube test.

The most important leakage to check is that between the cathode and filament, which is shown up by this test. It is important to operate the tube filament at its normal temperature, for some leakages will show up only when the filament is heated.

Gas Tests. The fact that gas causes a grid current flow makes it possible to check for gas by measuring this current. Some of the earliest tube testers used a micro-ammeter in the grid circuit. Such a meter, however, is rather expensive, and there is dan-

ger of burning it out. A somewhat simpler test device, like the one shown in Fig. 24, is now used on some testers.

To make the gas test, the push button switch S is first left in its normal closed position so the resistor R is shorted out of the circuit. The C bias and other voltages are adjusted to normal values, and the plate current, indicated by meter M , is noted. Then switch S is pressed; this opens the switch and places the resistor R in the grid circuit. Any grid current caused by gas now develops a bucking bias voltage across R , which, if it is appreciable, will cause a change in the plate current. This gives a very simple test for gas in a tube; if the tube has no gas content, depressing switch S will not cause a change in the plate current; if it has, pressing the switch will cause a large plate current change.

► Not all tube testers have this gas test feature. (Emission testers do not have this feature.) If yours does not, you can check a tube you suspect of

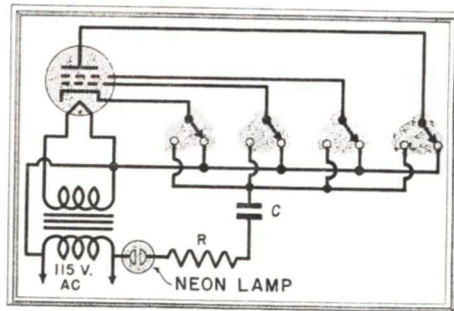

FIG. 23. One form of "shorts" tester.

being gassy by making measurements within the radio itself. As you will recall, a gassy tube causes trouble if there is a high resistance in the grid circuit, as in the ordinary resistance-capacitance coupled amplifier. Measuring for a voltage drop across the grid resistor when the set is turned

on (but with no signal tuned in) will quickly show whether the tube is gassy or not. If a voltage is across this resistor, then either the coupling condenser is leaky or the tube is gassy. Withdrawing the tube or disconnecting the coupling condenser will let you determine just which defect has caused the voltage drop.

Miscellaneous Tests. Tubes may also be tested for unusual defects by special procedures. You can very easily check to see whether vibration

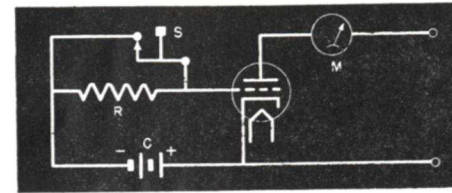

FIG. 24. A typical gas test circuit.

can cause tube elements to touch: while you are testing for leakage between the elements, just tap the tube and watch the neon lamp or short circuit indicator for signs of leakage. Or, you can tap on the tube while it is in the radio. If the radio makes a noise when you do so, then the tube is sensitive to vibration.

► If an earphone is connected in series with the plate of the tube, any variation in current caused by an intermittent short or loose element will result in noise in the headphone. Some tube testers have a phone jack to make this test possible.

In some cases, you will find that when you check a tube in a tester the meter pointer will swing up and then gradually swing down—or it may vary, first going one way and then the other. This indicates a varying emission which may cause fading reception. When you test a tube, leave your finger on the test button for a few seconds so that you can observe the steadiness of the meter reading.

If the tube is good, a relatively steady meter reading should be obtained. Don't worry about a small variation or movement of the meter pointer; this is probably the result of poor filtering in the power supply or fluctuations in line voltage. Consider only changes which cause relatively large variations in the meter reading.

TUBE TESTING PROCEDURE

The exact procedure for operating a tube tester will vary with the type of tester. Similarly, the setting of the controls will depend on the tester type. Always be sure you follow the manufacturer's instructions exactly.

However, in general, the following procedure will be used with most types of tube testers:

► 1. Turn on the tube tester, then rotate the line voltage adjustment control knob until a pointer comes to rest behind an illuminated shadow-graph scale (or, in other types of testers, until the meter needle comes up to a mark on the scale). The voltages applied to the filament and tube elements depend on this procedure.

► 2. Look up the tube type on the tester instruction chart, and set the filament control for the proper filament voltage. Set the circuit selector switch to the "short test" position. Plug in the tube. After the tube has warmed up, check the line voltage adjustment and, if necessary, reset the control.

► 3. Now test for shorts or leakage. Depending on the tester, this may be done by rotating a selector switch through various positions; by moving toggle switches according to the tester instructions; or by depressing push-buttons one at a time. Watch the neon lamp for a glow, indicating leakage or a short circuit. As you go through each of the short-testing

positions, tap the tube lightly with a lead pencil, or thump it by flicking your finger against it, to see if vibration will cause shorts or leakage. If there are shorts, the tube is bad and no further tests should be made.

► 4. If the tube successfully passes the short test, check its quality. Set the load control to the position given in the manufacturer's instructions, then throw the circuit selector (or toggle or push-button) switch to the proper position. The tester may now automatically indicate the tube quality on the meter scale, or it may be necessary to depress a button to get the reading.

► 5. If the tube gives an indication in the GOOD region of the meter scale, make any special tests the tester provides (such as a check for gas or for noise).

OBSOLESCENCE

Tube testers are subject to rapid obsolescence. When new tubes are brought out which have a different base arrangement, it is necessary to adapt the tube tester to accommodate them. The early tube testers were frequently out of date within just a few months, because of the complex nature of their switching arrangements and the rapid introduction of new tubes.

Sometimes adapters were made available to prolong the useful life of the tester. These adapters were plugged into one of the sockets on the tube tester, and the new tube was plugged into the adapter. The wiring in the adapter was arranged to make it possible to test the tube. However, soon so many adapters were necessary that it became impractical to continue this system.

► Today, tube testers have switching arrangements designed to minimize the possibility of new tube arrangements making the tester out of date. Of all the testers, the emission type is the easiest to arrange in this manner, which is one of the very important reasons why such testers are more popular than more elaborate ones.

Today, most tester manufacturers release data on each new tube to purchasers of their equipment, giving the control settings for testing the tube.

► When you buy a tube tester, make sure that it is the latest model available and that it is a type which will not go out of date quickly. Even so, you can expect to replace tube testers from time to time with later models. Bear this item of service expense in mind, and set aside funds from service earnings so you can replace such test equipment when necessary.

Lesson Questions

Be sure to number your Answer Sheet 45RH-1.

Place your Student number on every Answer Sheet.

Send in your set of answers for this lesson immediately after you finish them, as instructed in the Study Schedule. This will give you the greatest possible benefit from our speedy personal grading service.

1. What two revitalization steps are usually made during each service job?
2. What are the two standard output levels used for sensitivity measurements?
3. What advantage does a serviceman find in using a signal tracer for sensitivity measurements rather than the standard input-output measurements?
4. If the manufacturer lists gain values for an r.f. stage at 600 kc., would you expect measurements at 1400 kc. to give the same values?
5. Why must the a.v.c. be disconnected and a fixed bias be used when making gain measurements?
6. Suppose you make a signal voltage measurement across the primary of a double-tuned i.f. transformer. Would you expect the secondary voltage to be: 1, greater than; 2, the same as; or 3, less than the primary voltage?
7. When drying out a chassis, what is the purpose of the fan?
8. What are the three basic types of tube testers?
9. What test must always be made in the tube-testing procedure before the quality test is made?
10. Why should tubes be jarred while making a test for "shorts"?

THE N. R. I. COURSE PREPARES YOU TO BECOME A
RADIOTRICIAN & TELETRICIAN
(REGISTERED U.S. PATENT OFFICE)



WASTED TIME

A minute seems such a little thing—something most of us thoughtlessly throw away. But, just as pennies make dollars, so do minutes make hours. Few people realize that ten minutes wasted daily make over sixty hours—more than a work-week—in a year's time.

Study the habits of most successful men and you will find that they made use of odd moments, reading or writing, or *thinking*. Those precious minutes gave them the *extra* weeks, months, and years of time necessary to prepare and to advance themselves.

Now, time spent in healthful recreation is not being wasted. But, how much of your time is spent in idle amusements instead? How much time do you waste “stalling” before starting a task—doing unnecessary or useless things—or doing nothing at all?

Study your actions during the day. Make a list of the things you do. You'll be surprised at the number of five- or ten-minute intervals you can put to better use, in studying or planning for the future. Be ready for your opportunity when it comes!

J. E. Smith