

VACUUM TUBE VOLTMETERS

CATHODE RAY OSCILLOSCOPES

29 FR-2

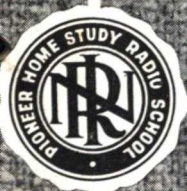

NATIONAL RADIO INSTITUTE

WASHINGTON, D. C.

ESTABLISHED 1914

STUDY SCHEDULE NO. 29

For each study step, read the assigned pages first at your usual speed. Reread slowly one or more times. Finish with one quick reading to fix the important facts firmly in your mind, then answer the Lesson Questions for that step. Study each other step in this same way.

1. A Basic D.C. Vacuum Tube Voltmeter Pages 1-5

The vacuum tube voltmeter is a radio stage with a means of indicating the voltage fed to it. Considerable ingenuity is used in getting the indications accurately and to eliminate effects of the v.t.v.m. on the circuit where voltages are to be checked and vice versa. You study a simple d.c. type to learn some of the problems and how they can be overcome. Answer Lesson Questions 1, 2 and 3.

2. Improved D.C. Vacuum Tube Voltmeters Pages 5-9

Improvements in sensitivity, so small voltages could be measured, led to the development of several more elaborate types for d.c. measurements. The bridge type you will study is one of the leading circuits in v.t.v.m. service instruments today, so study this section carefully. Answer Lesson Question 4.

3. A.C. Vacuum Tube Voltmeters Pages 9-13

We go back to our basic d.c. circuit and learn how it can be adapted to measure a.c. Many new problems now come up, particularly restrictions on the frequency range caused by test leads. Even the calibration requires care, as the wave shape will upset results. Answer Lesson Questions 5 and 6.

4. Peak Vacuum Tube Voltmeters Pages 13-17

Again, sensitivity needs lead to improved circuits—where not only more sensitivity, but freedom from test lead effects can be obtained. The diode rectifier type and the slide-back circuits in particular are important. Answer Lesson Question 7.

5. Special Vacuum Tube Voltmeters Pages 17-20

Here we take up vacuum tube indicators which use several stages of amplification. The tuned r.f. types are the "signal tracers" used by many service shops because of their ability to trace the signal through a radio, thus leading right to the trouble. There is also an important section on calibration of the v.t.v.m.—a procedure necessary at frequent intervals to maintain accuracy. Answer Lesson Question 8.

6. The Cathode Ray Oscilloscope Pages 20-28

This is a truly remarkable instrument—one which lets you "see" the signal. Here you learn how we get a spot of light, how to move the spot and how to make an exact tracing of the signal. Answer Questions 9 and 10.

7. Mail Your Answers for this Lesson to N.R.I. for Grading.

8. Start Studying the Next Lesson.

VACUUM TUBE VOLTMETERS CATHODE RAY OSCILLOSCOPES

A Basic D. C. Vacuum Tube Voltmeter

WHILE nearly all kinds of service work can be done with a standard service multimeter, some of the more difficult jobs can be done more quickly by using special instruments, such as the vacuum tube voltmeter and the cathode ray oscilloscope. For years, these instruments have been standard laboratory and factory equipment. As they are particularly suited for many special jobs, more and more of them are finding their way into the better equipped service shops. Especially as television and high-fidelity receivers become more widespread, there will be an increasing need for knowledge of the uses and limitations of these instruments. Both will be covered in this lesson.

► We will start with the vacuum tube voltmeter—originally developed as an r.f. voltmeter but which was soon used for d.c. measurements as well.

You recall that ordinary voltmeters affect the circuit whose voltage they measure—because they draw current and because they add the meter resistance to the circuit. Fortunately, in ordinary service work these effects are not usually serious, or can be allowed for. In other fields, however, they often make involved calculations necessary.

Even in a simple circuit like Fig. 1, the voltmeter will not indicate the true voltage across R unless its resistance is many times higher than that of R , as the voltmeter current through R_1 causes an additional voltage drop. As

you have learned, the voltmeter ohms-per-volt sensitivity determines the extent of the difference between the voltmeter reading and the actual voltage when the meter is removed.

Nowadays, standard meters have sensitivities of 1000 ohms-per-volt, which is acceptable for ordinary service work. For measurements in circuits containing reasonably high resistances, higher sensitivities up to 25,000 ohms-per-volt are available. But where very high resistances are used, as they are in so many radio applications, increased voltmeter sensitivity is needed. That's why d.c. vacuum tube voltmeters are used.

BASIC TRIODE V.T.V.M.

Fundamentally, a vacuum tube voltmeter is just an ordinary radio tube stage having an indicator instead of the usual plate load. Figure 2A shows a typical triode circuit. An E_g-I_p characteristic curve for this type tube is shown in Fig. 2B. By using the proper grid bias, we can operate on the straight part of the characteristic

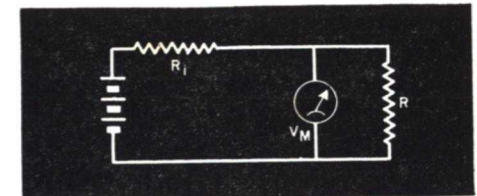

FIG. 1. The measurement depends on the voltmeter current, compared to that drawn by R .

(point 1), over a curved portion (point 2), at cut-off (3), or even beyond plate current cut-off (4), depending upon just what circuit action we want.

Suppose we operate on the straight part of the characteristic, the tube then acting as a class A amplifier. There will be a no-signal plate current, indicated by the meter in the plate circuit. We can make the meter read mid-scale for this current, either by using a shunt resistor across the meter or by adjusting the plate and grid voltages.

Now if we connect the test probes to a d.c. voltage source, current will flow through R_1 , causing a voltage drop across it. Since this voltage drop is between the grid and cathode, it will either increase or decrease the plate current, depending on the polarity of the drop. By calibrating the plate current meter properly, we can make it indicate the voltage of the source that R_1 is connected across, so we can make a simple d.c. vacuum tube voltmeter out of a standard radio tube amplifying circuit.

CIRCUIT LOADING

Why is our vacuum tube voltmeter (or "v.t.v.m.," as radio men call it) any better than an ordinary meter? We put the resistor R_1 across the source of voltage being measured—just as we'd have put the meter resistance across the source if we used an ordinary voltmeter. The difference is the fact that R_1 can be made very large. The only real limit on the size of R_1 is the grid current which may result from contact potential and gas within the tube. If resistor R_1 is too large, these tiny currents would cause a positive voltage drop across it which could nullify the C bias and cause erratic changes in plate current. However, resistor R_1 can be as high as 10 or 15 megohms. Just compare this with the

few thousand ohms introduced by the ordinary meter, and you can see that our v.t.v.m. will have far less effect on the circuit whose voltage we're measuring!

For example, if resistor R_1 is 15 megohms and 3 volts across it will give a full-scale meter deflection, the sensitivity of our v.t.v.m. is 5 megohms-per-volt. Commonly, sensitivities of from 1 to 5 megohms-per-volt are obtained on the basic range in commercial types. This is obviously many times higher than even the best 25,000 ohms-per-volt D'Arsonval meter.

► Of course, the simple circuit shown in Fig. 2 needs improvement. The calibration depends upon the characteristics of the particular tube used; no provisions are shown for extending the range; the device will be affected by any stray a.c. voltages; and the circuit does not make full use of the meter sensitivity. Let's see how these limitations can be cured.

CALIBRATION LINEARITY

No two radio tubes (even of the same type) have E_g-I_p characteristics which are exactly the same. Since the amount of plate current change for a particular applied grid voltage depends upon the shape of this curve, our v.t.v.m. would probably have to be recalibrated each time the tube burned out and a new one was put in. Furthermore, the shape of the characteristic is greatly affected by the supply voltages. As the batteries run down, the calibration will be thrown off.

One way to solve this difficulty is to use a relatively high plate load resistance in series with the meter. This makes the tube characteristic more nearly straight and less dependent on small supply voltage variations.

An even better scheme is to put a self-bias resistor (like R_2 in Fig 3) in the cathode lead. Now, with this ar-

range, if the plate current drops because of tube aging or battery supply reduction, the bias voltage will also drop. This tends to keep the plate current more nearly constant. As this bias changes with plate current variations caused by the applied voltage, this produces a bias which tends to oppose the applied voltage. The tube is forced to act as if it had a lower amplification factor, but the stage characteristics are made relatively independent of the tube and supply voltages. This method (called degenera-

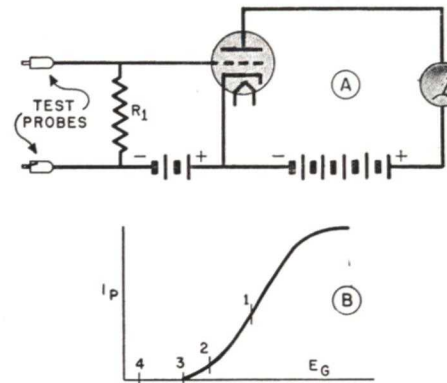

FIG. 2. An ordinary amplifier stage makes an excellent d.c. vacuum tube voltmeter, as the plate current is proportional to grid voltage.

tion) sacrifices some sensitivity, but the benefits outweigh the loss.

KEEPING OUT A.C.

Since the circuit in Fig. 2 is an amplifier, any a.c. voltage applied across resistor R_1 will cause an a.c. variation of the plate current. This will not affect the D'Arsonval meter, which indicates only the average d.c. plate current. However, if this a.c. exceeds the bias, the grid will swing positive and grid current will flow, which will cause false readings.

Figure 3 shows how a.c. troubles can be avoided. An extra resistor R_3 and a condenser C have been added in the grid circuit. These parts act as an

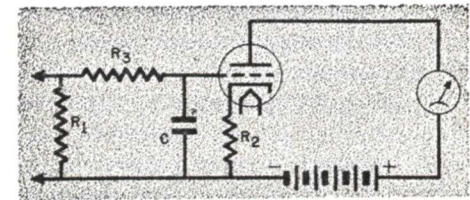

FIG. 3. The filter C- R_3 prevents a.c. ripples from affecting the d.c. voltage readings.

a.c. filter. The applied a.c. is dropped across R_3 , as its resistance is large compared to the low reactance of C . This reduces the level of any a.c. input voltages at the grid of the tube. Should these voltages still be high enough to swing the grid positive, R_1 - R_3 - C act as a grid leak and condenser, automatically biasing the tube. This scheme lets us measure the d.c. voltage in a circuit containing both a.c. and d.c., without the a.c. affecting the reading.

EXTENDING RANGES

Since we might want our v.t.v.m. to measure d.c. voltages ranging from just a fraction of a volt to 1000 volts or more, we need some means of extending the meter range.

Figure 4 shows the same method we used with an ordinary voltmeter. Resistor R_1 is the grid resistor of our vacuum tube voltmeter circuit and sets the basic range when the selector switch is in position 1. Then when the selector

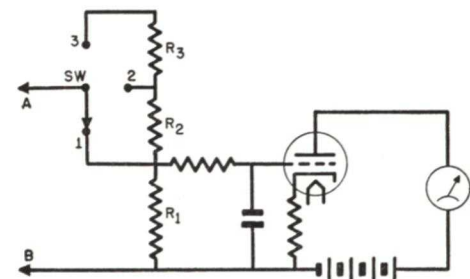

FIG. 4. The addition of series resistances extend the range, like the multipliers used with ordinary voltmeters.

switch is moved to position 2 or 3, the multiplying resistors R_2 or R_3 plus R_1 are added in series.

Since R_1 will probably be 1 or more megohms, R_2 and R_3 must have very high resistance values in order to extend the range. Very large resistances are not always available in compact, stable and exact sizes. Also, when the multiplying resistors are extremely high, any small amount of leakage across the selector switch or in the circuit will upset the voltage division.

► A better circuit is shown in Fig. 5. When the selector switch is in position 1, resistors R_1 , R_2 and R_3 are all across the grid-cathode of the tube, and all the input voltage is fed into our v.t.v.m. Switch position 1, therefore, sets the meter to its basic range.

When the selector switch is moved to position 2, only part of the input voltage is applied to the input of the v.t.v.m., as the circuit acts as a voltage divider. The exact amount of division depends upon the ratio of resistors R_1 plus R_2 to the total of R_1 plus R_2 plus R_3 . Similarly, when the selector switch is moved to position 3, the voltage across R_1 will be all that causes the meter deflection. Proper choice of resistance permits any desired range extension.

This circuit has the advantage of using easily obtainable resistor sizes. Also, it presents a constant d.c. impedance to the supply source regardless of the range chosen (provided there is no excessive leakage in the grid circuit of the vacuum tube). The ohms-per-volt sensitivity of this v.t.v.m. goes down as the range is increased, but this does not greatly matter—it is still far higher than the average meter.

MEASURING CURRENT

Can a v.t.v.m. be used to measure current? Yes—very easily. Just insert

a known resistor in series with the circuit carrying the current and measure the voltage across the resistor with the v.t.v.m. Ohm's Law ($I = E \div R$) does the rest. Of course, the known resistor should be made as small as possible so it won't have much effect on the circuit in which you insert it.

The range can be varied by using different resistors. For example, if 5 volts will give a full-scale reading, we can get a 50 ma. range by using a 100-ohm resistor ($.05 \times 100 = 5$ volts) or a 5-ma. range by using 1000 ohms.

MEASURING RESISTANCE

You can also measure resistance with a vacuum tube voltmeter. All you need is a known voltage source, as shown in Fig. 6. The resistor R_1 is a part of the v.t.v.m. and is, of course, a known resistance. The resistor R_x is the unknown one we want to measure. Here's how we do it.

First, the battery is connected between terminals A and B. This puts the battery right across resistor R_1 , and we get a deflection on our v.t.v.m. corresponding to the battery voltage. Usually the battery voltage is chosen or varied to give a full-scale meter deflection.

When the unknown resistance R_x is inserted in the circuit, the battery current flows through both R_x and resistor R_1 . This divides the voltage so

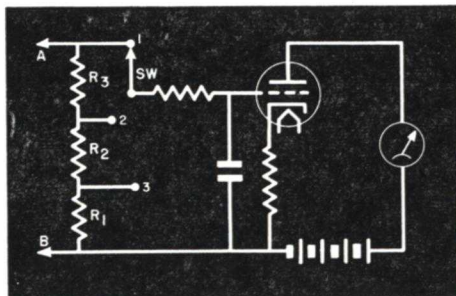

FIG. 5. A voltage divider method of extending the range.

the voltage drop across resistor R_1 is less than the total battery voltage. If resistor R_x exactly equals resistor R_1 , the voltage divides in half and we get a half-scale meter deflection. You remember that this is just how a regular ohmmeter works. Therefore, we can calibrate the v.t.v.m. scale in ohms, exactly as we do with any other ohmmeter.

The arrangement in Fig. 6 is much better than an ordinary ohmmeter for measuring high resistances. Resistor R_1 may be 10 megohms, which would give us a 10-megohm center-scale reading on our meter. Since we can read 100 times the center-scale value on an ohmmeter, this means we can readily measure unknown resistors as high as 1000 megohms, using only 3 volts or so as E . This means we can extend the range to far higher values and still use reasonable values of voltage. The method is the same we used with an ordinary ohmmeter—we add additional voltage and an additional resistance in series with it at point X. Thus, if the original circuit measures 1000 megohms with a 3-volt battery, a 30-volt battery will give a 10,000-megohm range, while 300 volts will increase the range to 100,000 megohms. Compare this sensitivity with that of an ordinary ohmmeter, where 300 volts may give a range of only 10 or 15 megohms!

The limit to the amount we can extend our range is the leakage resistance across insulation between jacks,

terminals and mountings for the various parts. To measure very high resistances, you must use extremely good insulating material and just as little of it as possible.

► Low resistances can also be measured with a v.t.v.m. by shunting R_1

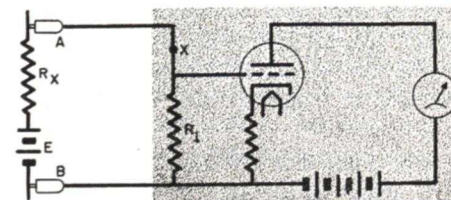

FIG. 6. Using the v.t.v.m. as an ohmmeter.

with a small resistor or replacing it with a low ohmic value to lower the center-scale value. By setting the R_1 value at, say, 100 ohms, the mid-scale ohmmeter reading will be 100 ohms and we can calibrate our meter accordingly.

V.T.V.M. as a Multimeter. Since we can use a v.t.v.m. to measure voltage, current and resistance, it is possible to make a multimeter using this basic circuit. By using switches, the proper ranges and functions can be obtained.

This arrangement would give us an extremely sensitive multimeter—which, however, would need frequent recalibrations and adjustments. Whenever the tube is changed, a complete recalibration may be necessary.

Improved D. C. Vacuum Tube Voltmeters

The circuits so far covered have been simple. They will work satisfactorily in measuring fairly high voltages. Now let's see how better d.c. vacuum tube voltmeters can be made.

Meter Sensitivity. So far, we've

been letting the normal plate current of the tube give our meter a mid-scale deflection. This has allowed us to neglect polarity in making measurements. However, it has also meant that we've had to use a fairly insensitive meter

For example, if the normal plate current is 10 ma., we must use a 20-ma. meter to have the normal plate current cause a mid-scale deflection. Then, the applied voltage must cause a 10-ma. plate current change to give us a full-scale deflection. Even if the tube has a high mutual conductance, a 10-ma. plate current change requires a fairly high grid voltage, so the basic range of our v.t.v.m. is high. This means low voltages produce only small changes in plate current and are not easily read.

But if we can have our meter read zero when no voltage is being measured, we can use a much more sensitive meter—1 ma., for example. To do so, we must find some means of having zero plate current when there is zero grid input. How can this be done?

One way is to apply a higher bias and to work the tube at or near the plate current cut-off point. This is frequently done, but has the disadvantage of making the tube operate over a curved part of its characteristic. This means that plate current—and therefore meter readings—will not be linear for different applied voltages. Even worse, our meter will deflect least for small voltages, where we want the greatest sensitivity. A better plan is to let the tube operate on the straight part of its characteristic and use a bucking circuit to get zero plate current.

BUCKING CIRCUITS

Figure 7 shows one common bucking circuit. The normal plate electron flow of the tube (solid arrows) and the electron flow caused by the bucking battery *E* (dotted arrows) flow through the meter in opposite directions. Resistor *R* is carefully adjusted so that the current from *E* exactly equals the tube current. The meter then has equal and opposite currents

flowing through it, so it reads zero. This is called a bucking circuit, as the extra current “bucks” or cancels the plate current through the meter.

Now when a voltage is applied to the grid of the tube, the plate current of the tube changes, while the bucking current remains the same. Then the meter indicates the difference between the two currents—in other words, the actual change in the tube plate current.

You can readily see that in using such a circuit we must be sure that the voltage applied to the grid makes it more *positive*. A more positive grid causes an increase in plate current, which will make the meter deflect upscale, as we want it to.

As you have learned, the important advantage of such a circuit is that we can use a more sensitive meter in the plate circuit, instead of the 10 or 20-ma. meter needed in simpler vacuum tube voltmeters. If the tube has such a characteristic that a 1-volt change

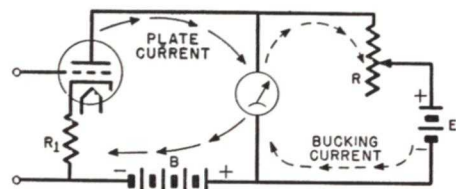

FIG. 7. The bucking current cancels the plate current flow through the meter.

on the grid causes a 1-ma. change in plate current, and a 1-ma. meter is used, the basic range of our improved v.t.v.m. is 1 volt. (By using a more sensitive meter, we can get an even lower basic range.) Furthermore, this 1-volt scale is now spread over the entire meter scale instead of half of it, which alone doubles the scale sensitivity.

There are many variations of this bucking circuit, but all have disadvantages. If *R* is not adjusted almost per-

fectly, the meter may be overloaded and burned out. This means the meter must be shunted until *R* is adjusted. Further, the separate battery is a nuisance—among other things, its voltage decreases as it grows older. Several better circuits, using the bridge principle, have been developed. Let's see how they work.

D.C. BRIDGE V.T.V.M.

You will study the bridge circuit in more detail later, so here we'll just go into the basic principles briefly. A typical bridge is shown in Fig. 8.

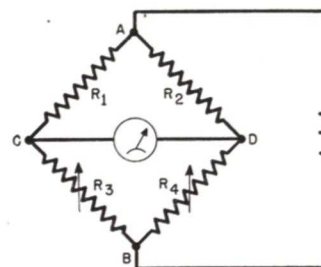

FIG. 8. A resistance bridge.

When a voltage is applied across terminals *A* and *B*, current flows through *R*₁ and *R*₃, as well as through *R*₂ and *R*₄. If we make *R*₁ equal *R*₂ and *R*₃ equal *R*₄, the resistance of *R*₁ plus *R*₃ will equal *R*₂ plus *R*₄, so the current through path *A-C-B* is equal to that through path *A-D-B*. This makes the voltage drop across *R*₁ equal to that across *R*₂, so the potential of point *C* with respect to *A* is the same as that of *D* with respect to *A*. Hence, points *C* and *D* are at the *same potential* (no voltage difference between them)—and *no current* flows through the meter. The bridge is said to be “balanced” when the meter reads zero.

When either pair of resistors is made unequal (*R*₁ not equal to *R*₂, or *R*₃ not equal to *R*₄), there will be a voltage difference between *C* and *D*, so current will flow through the meter.

The bridge is now unbalanced.

To use this bridge principle in our v.t.v.m., we set up the circuit shown in Fig. 9. This is much the same as the circuit in Fig. 8, except that we've replaced variable resistor *R*₃ with a tube and bias resistor *R*₆. Resistors *R*₁ and *R*₂ are equal in value.

With no input on the grid, we balance this circuit by adjusting *R*₄ until no current flows in the meter. As you just learned, this means that *R*₄ equals the plate-cathode resistance of the tube plus the resistance of *R*₆.

Now if we apply an input to the grid through terminals *X* and *Y*, the resulting grid voltage changes the tube plate current. This current change means the plate-cathode tube resistance has changed—so the bridge is no longer balanced and current flows through the meter. Calibrating the meter in terms of voltage input to the grid gives us our v.t.v.m.

Regulating the Power Supply. It is usually preferable to use a power pack for our bridge type v.t.v.m., instead of a battery. But such a power supply must be very well regulated. Changes in the supply voltage will shift operation of the tube to a different part of its characteristic and, as you know, this destroys the calibration of the v.t.v.m.

One common method of regulation,

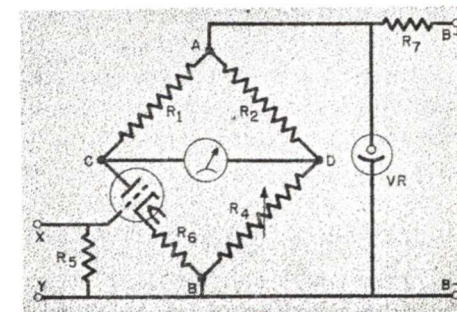

FIG. 9. Using a tube in a bridge in place of a resistance leg.

using a voltage regulator tube *VR* and a series resistor *R*₇, is shown in Fig. 9. This tube has the property of passing a much higher current when the voltage across it increases slightly. The voltage drop this current causes in resistor *R*₇ then drops the voltage across *VR*. The net effect is to keep the voltage across *VR*, which is the voltage supplied to the v.t.v.m., very nearly constant. Under normal conditions, a modern regulator tube can maintain the voltage across its terminals within 2 or 3 volts of its rated value.

An Improved Circuit. An even better bridge type v.t.v.m. circuit is shown in Fig. 10. Here another tube, exactly like the first one, is used in place of resistor *R*₄ of our original bridge circuit.

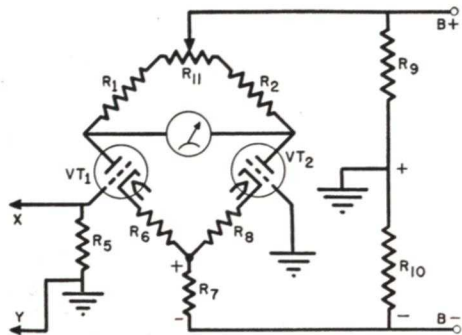

FIG. 10. A balanced tube bridge.

The use of two tubes tends to cancel the effects of any change in supply voltage. In other words, if the supply voltage increases, the plate current to both tubes increases correspondingly, and the bridge remains in balance, thus eliminating the need for a regulator tube.

► Resistors *R*₆ and *R*₈ are used to make the tubes bias themselves. This also helps keep the circuit in balance.

► An unusual feature of the circuit in Fig. 10 is the use of *R*₇ to get greater stability and higher sensitivity. Both plate currents flow through this re-

sistor, producing a voltage having the polarity indicated, so more self-biasing is produced. However, this bias voltage is high enough to cut the tube currents off except for the fact that it is bucked out by a positive voltage from *R*₁₀. (Trace the grid circuits to ground, to the junction of *R*₉ and *R*₁₀, then through *R*₇ to each cathode to see this.) Now the resulting net bias is about that of each cathode resistor.

When a voltage is applied to the input of *VT*₁, so that terminal *X* is made positive with respect to terminal *Y*, the plate current of *VT*₁ increases. This causes an increased flow of current through resistor *R*₇, thus biasing the grid of *VT*₂ more negatively. (The positive *R*₁₀ drop remains fixed, but the negative *R*₇ drop increases, so the net effect is more negative bias on *VT*₂.) Therefore, the plate current of tube *VT*₂ goes down.

This means that the plate resistance of tube *VT*₁ goes down at the same time the plate resistance of *VT*₂ goes



FIG. 11. The RCA-Rider Volt-Ohmyst Jr. is a typical d.c. type v.t.v.m. using the balanced bridge circuit.

up. Therefore, this bridge becomes much more unbalanced for a given input than does the circuit in Fig. 9, and so is more sensitive. Also, the v.t.v.m. in Fig. 10 can be made more linear-reading than the Fig. 9 v.t.v.m. by choosing tubes whose characteristics balance each other.

An exact balance of the bridge (zero meter adjustment) is obtained by adjusting *R*₁₁. Varying this resistor varies *R*₁ and *R*₂, adding to one and subtracting from the other. This varies the tube plate voltages, so the tube resistances change also. If the ratio of *R*₁ to *R*₂ is made the same as the ratio of *R*₃ to *R*₄, the currents in the two paths will adjust themselves so that the same voltage drops occur, even though the currents are unequal. This ratio is usually given as $\frac{R_1}{R_2} = \frac{R_3}{R_4}$.

Notice that it is not necessary that *R*₁ = *R*₂ or *R*₃ = *R*₄, just so the ratio of values is properly chosen.

A COMMERCIAL BRIDGE V.T.V.M.

A typical commercial bridge instrument is the RCA Junior Volt-Ohmyst shown in Fig. 11. Its circuit is basically the same as that of Fig. 10, with provisions to extend ranges and measure resistance.

The Junior Volt-Ohmyst may be used as a multi-range d.c. type v.t.v.m., as a low- and high-range ohmmeter, or as an a.c. voltmeter. Selector switches permit changeover to the desired range and function. The a.c. voltmeter incorporated in the instrument is a standard copper-oxide rectifier type—not an a.c. vacuum tube voltmeter, so this is a d.c. type v.t.v.m.

A. C. Vacuum Tube Voltmeters

You recall that most standard a.c. voltmeters have distributed inductance and capacity which ruin calibration when you try to use them on high-frequency a.c. Highly sensitive a.c. vacuum tube voltmeters have been developed which are relatively free from frequency errors and limitations, even at radio frequencies. Let's see how they work.

A TRIODE A.C. TYPE V.T.V.M.

You learned that the basic d.c. v.t.v.m. shown in Fig. 2A won't indicate on a.c. because the tube is worked on a straight part of its characteristic. Thus, an a.c. grid input produces an a.c. plate current varying around the normal plate current—and the average of this a.c. plate current (which is all the meter can read) is just the same as the normal plate current. (See Fig.

12.) Therefore, the meter reads only the normal plate current as long as we operate the tube on the straight part of its characteristic.

But by changing the bias so as to move the operation to the curved part of the characteristic, or to plate current cut-off, we get the detector action shown in Fig. 13. Now there is little or no plate current when no signal is applied to the grid. When an a.c. voltage is applied, rectified pulses are produced which have an average different from the no-signal plate current. This difference in average plate current can be read on a meter.

Sensitivity. With this change in operating point, the circuit in Fig. 2A will read both d.c. and a.c. voltages, provided the d.c. voltage has a polarity which makes the grid positive. How-

ever, the meter scale is not at all linear, because of the curve of the tube characteristic near plate current cut-off. This means very little meter deflection is obtained for small voltages, so the scale is crowded and difficult to read at the low end.

As the applied voltage is increased, the meter deflection becomes more linear, so this circuit is satisfactory for fairly large voltages. Farther on

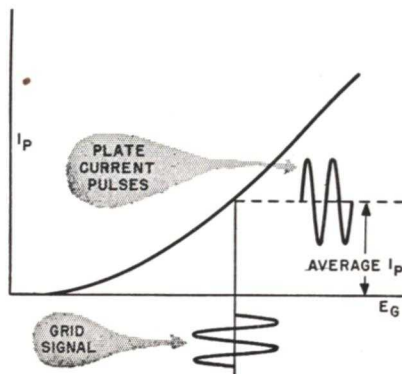

FIG. 12. The d.c. average of the plate current does not change when an a.c. voltage is applied to a class A amplifier.

in this lesson we'll take up circuits for measuring low voltages.

Frequency Range. With the proper tube and circuit arrangement, we can measure very high radio frequencies on our a.c. vacuum tube voltmeter. The limit to which we can go before the scale calibration becomes inaccurate is determined primarily by the input circuit of the v.t.v.m. and the circuit where measurements are being made. The input capacity of the tube is in parallel with the grid resistance. As frequency goes up, the reactance of this input capacity goes down. This reduces the impedance between the input terminals, so our v.t.v.m. will eventually start loading the circuit across which it is connected.

This loading is not so serious when the v.t.v.m. is connected across a tuned

circuit. Since the v.t.v.m. is primarily a capacitive load, it will detune the resonant circuit. If we retune the circuit with the v.t.v.m. in place, we can automatically cancel this effect and make our measurements. Of course, the circuit must be retuned to the original frequency when the v.t.v.m. is removed.

Test Lead Effects. In measuring r.f. voltages, it is desirable to use a shielded test lead to connect our v.t.v.m. to the circuit being measured. Shielding prevents the leads from picking up hum or other stray voltages which would produce false readings. However, the capacity between the shielded lead and the shield is connected in parallel with the tube input capacity. This increases the load introduced into the measured circuit, so

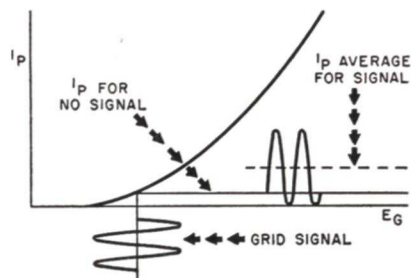

FIG. 13. By moving to the curved portion of the characteristic, there will be a d.c. average change from the no-signal value, when an a.c. voltage is applied.

a shielded lead further limits the frequency range.

Test Lead Resonance. The test leads become resonant whenever their physical length equals a quarter wavelength at the frequency where measurements are being made. At a frequency of 75 megacycles (4 meters), leads about 3 feet long would be a $\frac{1}{4}$ wavelength line.

As you'll learn in another lesson, a quarter-wave line has an unusual voltage distribution. If we apply a high

voltage to one end, we get very little or no voltage from the other end. Obviously, this would make our v.t.v.m. reading highly inaccurate!

While this quarter-wave effect occurs only at resonance, the test leads begin to affect the voltage at frequencies considerably lower. In general, a v.t.v.m. using test leads cannot be used

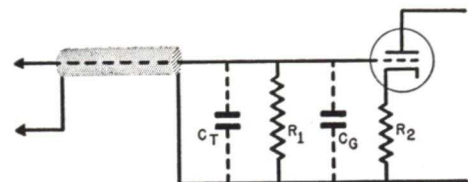

FIG. 14. The input circuit of an a.c. type v.t.v.m.

for voltages with frequencies greater than one or two megacycles, unless special calibration charts are provided. This is still quite an improvement over the standard a.c. voltmeter. Later on, we will see how voltages can be measured at higher frequencies.

Extending A.C. Ranges. The input circuit for the basic range of our v.t.v.m. is similar to the circuit shown in Fig. 14 where we have input resistance R_1 shunted by C_T and C_G , the test lead capacity and the tube input capacity respectively.

If we try to use the voltage-dividing circuit shown in Fig. 15 which worked so well for d.c., we find that C_G causes trouble. Moving the selector switch to

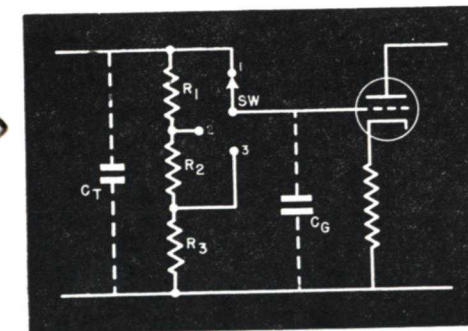

FIG. 15. The tube capacity upsets the voltage division as the switch is rotated.

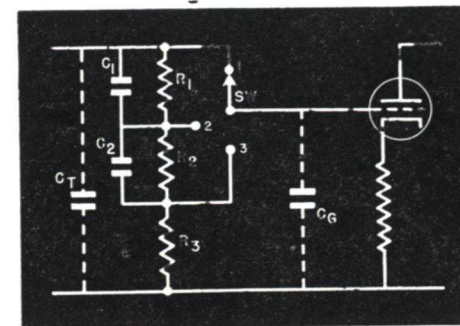

FIG. 16. This capacity voltage divider gives uniform a.c. voltage division.

position 2 shunts C_G across resistors R_2 and R_3 . Since the reactance of C_G varies with frequency, the impedance of C_G in parallel with R_2 and R_3 will vary with frequency, while the resistance of R_1 remains constant. This means that the voltage division across the divider also varies with frequency—so the range we get at position 2 (or at position 3) depends on the frequency of the input voltage.

We can clear up this difficulty by using a capacitive voltage divider like that shown in Fig. 16. When used to measure a.c. voltages, the division of voltages across this divider is determined by the reactances of the condensers. In position 2, the a.c. voltage division is determined by the reactances of C_1 and C_G . In position 3, C_2 is added to C_1 , so the combined reactance to that of C_G is the divider. Since these reactances all vary in the same manner when the input frequency varies, the division of voltages remains the same, and the various ranges of our v.t.v.m. are therefore very nearly independent of frequency.

► This v.t.v.m. circuit may also be used to measure d.c. voltages. In this use, the condensers have no effect and the resistors determine the voltage division for the instrument's ranges, just as they did in the circuit shown in Fig. 5.

A.C. WAVE SHAPES

You recall that an a.c. cycle has a peak value, an average value and an effective value. Because we are usually most interested in the r.m.s. value of a sine wave, we calibrate an a.c. type of v.t.v.m. to indicate r.m.s. values.

But the meter of an a.c. type v.t.v.m. actually operates from the *average* of the plate current. Now the average plate current is not the same as the effective or r.m.s. value—so we have a meter which really operates on one value of an a.c. wave but is calibrated to indicate another.

This is perfectly all right as long as the ratio of the r.m.s. value to the average value is constant—as it is for any regular wave shape. If you want to determine the average value of the a.c., all you have to do is multiply the meter scale reading by the proper multiplying factor. The peak value can also be determined in the same way (using a different factor, of course).

But you must remember that the exact ratios between the r.m.s., average and peak values of a wave depend on the wave shape. Figure 17 shows the relationships existing in various kinds of waves. Notice that all these waves have a *different* peak-to-average-to-r.m.s. relationship. (The special wave of Fig. 17E is similar to television control pulses and has widely different r.m.s. and average values, depending on the height and width of the pulses as well as their spacing.)

Distorted Waves. The meter of a v.t.v.m. intended for service work is usually calibrated to read r.m.s. values when the instrument is measuring a pure sine wave. The readings may be in error if such a v.t.v.m. is used to measure a distorted wave, because the distorted wave will probably not have the same average-to-r.m.s. relationship as a sine wave.

Suppose we start with a sine wave, but one receiver stage distorts the wave as shown in Fig. 18. One-half the wave is practically a square wave, while the other half remains a sine wave. This is commonly the result of an amplifying tube operating too near the current cut-off point.

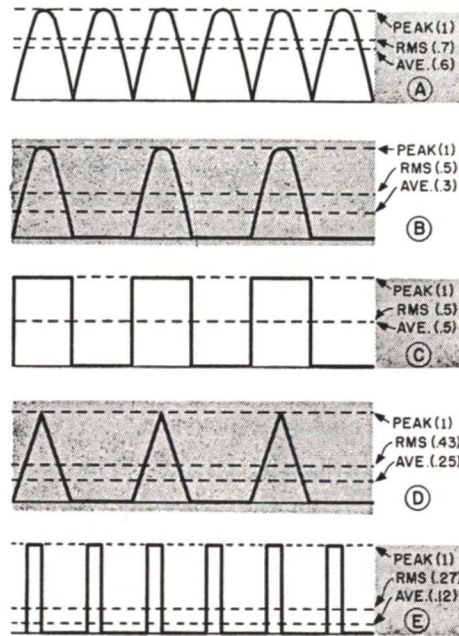

FIG. 17. The shape and size of the wave pulse determines the relationship between the peak, average and r.m.s. values.

If we apply our test leads in such a manner that the sine portion of this wave makes the grid of the v.t.v.m. more positive, we'll get an indication which corresponds to the effective value of the sine wave.

On the other hand, if we reverse the test leads, the rectifying action of the v.t.v.m. will cut off the sine wave portion and we will get an indication corresponding to the distorted half of the cycle. This will give us an entirely different reading from the first one, be-

cause the relationship between the peak, average and effective values will be different. Distorted waves of this kind cause more error with a *peak* v.t.v.m. (to be studied later) than with *average* types (such as we have already discussed), because the peak is always very different from the r.m.s. value while the average and r.m.s. values are usually fairly close to each other.

► Reversing the v.t.v.m. leads may produce different readings even on an undistorted wave, because of the difference in capacity to ground between leads or parts in the v.t.v.m. The different readings caused by reversing leads is an effect known as "turnover."

Usually a shielded cable is provided to connect the v.t.v.m. to the radio being tested, with the shield used as one of the probes. Since the shield is always connected to an r.f. grounded

point in the radio, the hot probe will always be the probe for measuring voltage, and it will not be possible to reverse the probes. Remember, however, that each amplifying stage reverses the phase of a signal 180°—

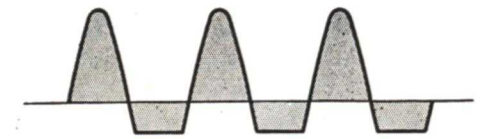

FIG. 18. A distorted wave, such as might be produced by operating a tube at the wrong point on the characteristic.

which produces exactly the same effect as reversing the leads—so it is still possible for distortion to produce an error in the reading as we go from stage to stage. Fortunately, in servicing, we are generally interested more in the *presence* of voltage than in the exact amount, so this problem is mostly limited to laboratory work.

Peak Vacuum Tube Voltmeters

A diode rectifier can be used like a copper-oxide rectifier, with a d.c. meter to make an a.c. voltmeter. The diode will give the voltmeter a wider frequency range, but otherwise has no advantages. Yet, a simple change in this diode circuit will make it one of the most valuable v.t.v.m. types.

PEAK-RESPONDING DIODE V.T.V.M.

The diode circuit just mentioned would have a bypass condenser across the meter, to prevent a.c. flow through the movement. By moving this condenser to the position shown in Fig. 19 and using a resistor R_1 , to set up an R-C time-constant circuit, we will have a peak-responding v.t.v.m.

When the plate of diode VT is made positive by the voltage source, con-

denser C is charged.

When the cycle reverses, the tube stops conducting and C starts to discharge through R_1 . However, R_1 is so large that condenser C does not have time to discharge very much before the cycle reverses and charges it up again. When fully charged, C has a voltage equal to the source voltage peak. After some of this charge has leaked off during the half cycle the tube does not conduct, the voltage drops somewhat. When the cycle reverses again, the tube can't conduct until the source voltage becomes higher than the reduced condenser voltage. When the tube does conduct, the condenser is charged to full source voltage almost at once.

The net result of this circuit action

is that C always has a voltage very near the peak voltage of the source. Since C is in parallel with the series combination of R_1 and the meter, this combination also has practically all the peak voltage across it all the time. This peak voltage causes a current flow through the meter—so we have a v.t.v.m. which indicates peak voltages.

► Unfortunately, R_1 has to be so high in resistance that very little current flows through the meter. A very small current change occurs for even large voltage changes so the meter does not make a good indicator. However, we can easily solve this problem.

If we remove the meter altogether, R_1 will have practically all the peak

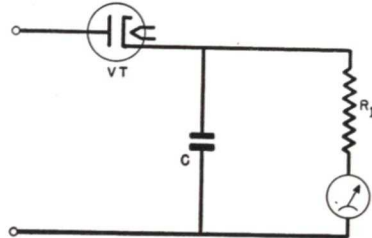

FIG. 19. A simple diode peak-indicating a.c. type v.t.v.m.

source voltage across it all the time. You'll notice that the action of the tube and condenser makes the voltage across R_1 a d.c. voltage. Therefore, all we have to do is put a d.c. type v.t.v.m. across R_1 , and we'll have a sensitive way of measuring the peak voltage of the a.c. source.

► Since this circuit draws current from the source only at the peaks of the applied voltage, this v.t.v.m. acts as if it had a very high resistance. When it is used to measure high frequency, the amount it loads the voltage source depends mostly on the capacity between the input terminals. The plate-cathode capacity of the tube is in series with condenser C , across the terminals, but condenser C offers low reactance to r.f., so the loading

depends primarily upon the internal tube capacity.

An Improved Circuit. An even better circuit is shown in Fig. 20. Here's how it works.

During the half of an input a.c. cycle that makes terminal A positive with respect to terminal B , the diode conducts. Electrons flowing through the tube charge C_1 to the peak source voltage, with the polarity shown.

When the input cycle reverses and the tube ceases to conduct, the voltage on the condenser and the input voltage combine to cause an electron flow through R_1 . However, the time constant of C_1 and R_1 in series is so high that C_1 discharges only a little during this time. C_1 is thus only a little below the source voltage when the cycle reverses again. As soon as the source voltage rises above the voltage on C_1 , the tube conducts again, and C_1 is rapidly charged up to full peak voltage.

Thus this circuit acts in much the

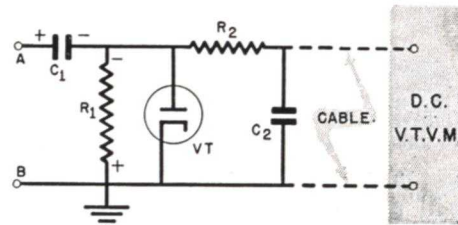
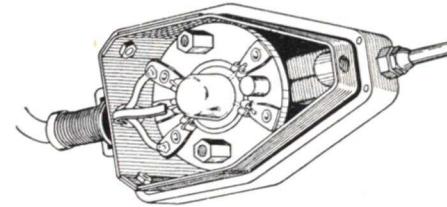

FIG. 20. An improved peak v.t.v.m.

same way as the previous one—almost the full peak voltage remains on C_1 all the time, and the circuit draws current from the source only when the peak value exceeds the C_1 voltage. Thus, the circuit draws but little current from the source.

► The voltage indications are obtained from the d.c. type vacuum tube voltmeter which is connected through filter R_2-C_2 so that it measures the voltage across R_1 . Any r.f. across R_1 is prevented from getting to the v.t.v.m. by the a.c. filter R_2-C_2 .

On the half cycle when terminal B is positive, the voltage across C_1 and the source voltage combine to force a small current through the high resistance, R_1 . The resulting voltage drop across R_1 has a d.c. average which operates the v.t.v.m. On the other half cycle, the source voltage and that across C_1 buck or oppose each other. Hence, there is practically no current through R_1 on this half cycle.



Courtesy P. R. Mallory Co.

FIG. 21. An acorn type tube, mounted right in the probe, provides a minimum of input capacity, allowing measurements up to several hundred mc.

► At low frequencies, the time between reversals of the input voltage may become so great that nearly all the charge leaks off C_1 . The circuit then ceases to be a peak-indicating device. However, it is easy to give C_1 and R_1 such a high time constant that the frequency at which this effect occurs is quite low.

► The amount this circuit loads the measured circuit depends on the plate-cathode capacity of the tube and on stray capacity between the terminals and between C_1 and ground. By using a tube with extremely low capacity, such as one of the modern acorn type tubes, we can reduce this capacity so that very high frequencies can be measured. In fact, we can mount the tube right in the test probe, and so eliminate most of the difficulties with test leads that you learned about earlier in this lesson. Figure 21 shows a tube mounted in this fashion. Using such a probe and reducing stray ca-

pacities in the circuit to a minimum, we can measure voltages at several hundred megacycles with this instrument.

There are three important things to remember about this type of v.t.v.m.:

1. It can be made fairly sensitive.
2. It can be used at extremely high frequencies.
3. It will not load the measured circuit much.

► It is possible to change the range of a v.t.v.m. of this type by using a multi-range d.c. vacuum tube voltmeter.

► The peak-responding type of v.t.v.m. is more sensitive than average-



Courtesy General Radio Co.

A vacuum tube voltmeter capable of measuring r.f. voltages up to several hundred megacycles. An acorn type tube is mounted right in the probe unit to reduce input capacity and make such high-frequency measurements possible.

indicating types, because the peak value of a wave is almost always reasonably high and so provides enough voltage to operate the meter—while the average voltage may be quite low. However, since a peak v.t.v.m. is usually equipped with a meter calibrated to indicate r.m.s. or effective values, it may give incorrect readings on distorted waves.

SLIDE-BACK V.T.V.M. CIRCUITS

There is another kind of v.t.v.m. used to measure peak values. It is known as the "slide-back" type.

A typical circuit is shown in Fig. 22. In using it, the slider of potentiometer P is first moved to point 1. The voltmeter V_M then reads zero. Next, with no signal applied (terminals A and B shorted together), the small tube current is read on meter I_M . This is not quite zero, because contact potential within the tube causes a small amount of current flow. The exact amount of current does not matter, just so we remember it.

Then the voltage to be measured is applied between terminals A and B . This causes a current flow through the meter I_M and through resistor R_1 . Resistor R_1 and condenser C_1 can be so chosen that this current will cause a meter deflection proportional to the peak value of the applied voltage.

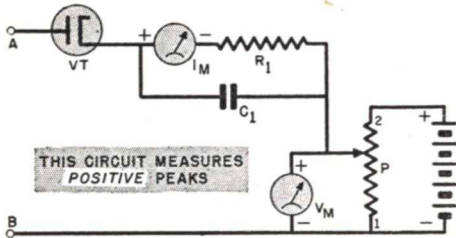

FIG. 22. A positive-peak slide-back v.t.v.m.

Now, with the signal still applied, potentiometer P is adjusted to bring the pointer of current meter I_M back to its initial position. In other words, the potentiometer P is used to introduce a bucking voltage from the battery into the circuit. When this bucking voltage just brings I_M back to its initial reading, it is equal to the peak signal voltage. Then all we have to do is read the bucking voltage on meter V_M , and we know what the peak voltage is.

► This circuit has several advantages. We don't have to calibrate meter I_M ,

because we use only its initial pointer position. Also, the characteristics of the tube and other parts aren't very important. In fact, the accuracy of the measurement in a properly adjusted circuit depends only on the accuracy of the d.c. meter V_M .

Some precautions must be taken in using this slide-back meter, however. Principally, you must be sure to adjust the potentiometer just enough to bring I_M back to its initial reading and

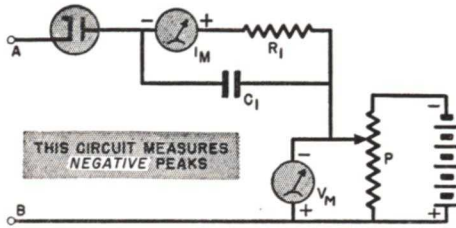

FIG. 23. A negative-peak slide-back v.t.v.m.

no farther, to prevent errors in the reading.

Negative Peak Indicator. The circuit in Fig. 22 works whenever terminal A is made positive with respect to terminal B . Therefore, this device indicates on d.c. as well as a.c.

Should the polarity be reversed or should we want to measure the other half of the a.c. cycle, we can reverse the terminals A and B . Sometimes it is not a good plan to do this, as there may be capacity effects that would affect the readings. Also, it may be necessary or desirable to ground terminal B .

These possible difficulties make it better to leave terminals A and B connected as before, and change the circuit as shown in Fig. 23. Here the diode, the meter I_M and the slide-back battery have been reversed. Now, when terminal A is negative (B is positive), the diode passes current and the instrument works as before—except that it measures the negative peaks.

Using Slide-Back Voltmeters. As

there must be a small tube current so that the meter I_M will indicate, there is some rectification of the extreme tips of the a.c. cycle. This produces an error of about .5 volt, which is appreciable on low-voltage measurements but is negligible on high voltages. This error must be allowed for when measuring voltages below about 25 volts.

► To protect the instrument, always operate it in the following manner:

Short the input terminals and make a note of the initial I_M reading. (All practical types have an extra biasing battery and potentiometer with which you can adjust the initial current to a small value.) Then apply the maximum slide-back battery voltage before connecting to the unknown voltage source. After the unknown voltage is applied, adjust the potentiometer until meter I_M rises from zero to its initial reading. This procedure protects the current meter.

Triode Slide-Back V.T.V.M. You can use a triode tube as a slide-back

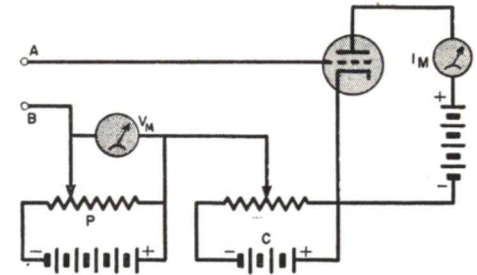

FIG. 24. A triode slide-back v.t.v.m.

v.t.v.m., as shown in Fig. 24. With terminals A and B shorted, the C bias is adjusted to give some particular value of the initial I_M . Then the maximum slide-back voltage is introduced by potentiometer P . With the unknown voltage now applied to terminals A and B , the potentiometer setting is reduced until the meter I_M returns to its original reading. The V_M reading is then equal to the peak voltage applied.

This circuit can only be used to measure positive peaks. However, it causes less loading of the source of voltage, as the grid circuit draws no current from the source.

Special Vacuum Tube Voltmeters

TUNED RADIO FREQUENCY V.T.V.M.

Some of the peak vacuum tube voltmeters we've studied can be made to have a basic range of about 1 volt, which is sufficient for many r.f. measurements. However, to measure the small voltages in the r.f. stages of a receiver, we need a much more sensitive instrument.

Furthermore, all the a.c. types studied so far have one fault. They measure any input signal, whether it's the one we want or not. Noise pulses, hum, or additional r.f. voltages that happen to be in the circuit will be measured right along with the signal whose voltage we're trying to measure.

Now, we can overcome this difficulty by using a tuned circuit. As you know, a resonant circuit has the ability to separate frequencies. By tuning a resonant circuit to the desired frequency and using it in our v.t.v.m. ahead of the d.c. indicator, we can make measurements at just the frequency we want.

A resonant circuit also makes it possible to use several amplifying stages ahead of the rectifier in our peak v.t.v.m., coupling from stage to stage just as in a radio receiver. This, of course, gives us the extra sensitivity we need for measuring small voltages.

► What kind of amplifier shall we use? A superheterodyne? No—because

the superheterodyne will itself produce interfering signals unless extreme care is exercised. Instead, we use tuned radio frequency stages in our amplifier. Although the stage gain with a t.r.f. circuit is not as great as with a superhet, the former gives us a more reliable instrument.

► We don't use a tuned circuit at the input of the vacuum tube amplifier. If we did, as soon as we connected the input across the radio part whose voltage we wanted to measure, the tuned circuit would either be detuned by the reactive component of that part, or be so loaded by the resistive component that the Q of the circuit would drop. Either condition would cause a loss of amplification, and so make the calibration of our v.t.v.m. inaccurate.

Instead, we use a special untuned input circuit which feeds into an amplifying tube. The tube then feeds into a tuned coupler which connects to the next tube in line. The special input circuit, by sacrificing some amplification, eliminates the effects of the shielded cable and tube input capacities. This means the input loading is reduced and the input will not detune the signal source.

Figure 25 shows the input circuit. Capacity C_T represents the input tube capacity combined with the shielded cable capacity. We'll first analyze its operation with the switch *SW* in position 1.

The circuit is connected to the point of measurement by two leads. One is a grounded lead (usually clipped to the chassis of the radio under test). The other is a shielded cable about 3 feet long with a test probe at the end. The test probe of the shielded cable is the secret of this device. Inside the insulating sleeve of the probe is a small mica condenser C_1 , usually between 1 and 4 mmfd., which connects the probe point *P* and the "hot" inner cable lead.

This probe capacity is in series with the signal source and capacity C_T . Since C_1 is much smaller than C_T , and capacities in series give a value less than the smallest, the maximum capacity across the circuit where measurements are made will be approximately the probe capacity. This value is so small that practically no detuning of the signal source will occur at low or medium radio frequencies.

When probe point *P* is connected to an r.f. or i.f. terminal, the source voltage divides between the probe capacity C_1 and capacity C_T . If the input capacity C_T is 100 mmfd. and the probe-to-cable capacity C_1 is 2 mmfd., 1/50 of the source voltage is applied to the tube input. If the amplifier has a gain of 50,000, the net over-all gain of the v.t.v.m. is $50,000 \div 50$, or 1000 times. Thus, we sacrifice some of the gain to use the probe capacity and avoid detuning and loading effects—but we still have considerable amplification left.

The voltage division will remain the same for all frequencies which are low enough to allow the cable to act essentially as a capacity (no resonant effects). The average limit is about 5 mc. Since most of the service measurements normally made with this instrument will be below 2 mc., this is not much of a limitation. In a factory-built unit, the tuning range is restricted to those frequencies where reasonably flat response can be obtained.

The probe capacity allows us to use a capacity voltage divider to obtain extra ranges. Turning switch *SW* to position 2 puts C_2 in parallel with C_T . If C_2 is 900 mmfd. and C_T is 100 mmfd., the total shunting capacity is now 1000 mmfd. Assuming the probe-to-cable capacity C_1 is 2 mmfd., the voltage division is now in the ratio of 2 to 1000, so only 1/500 of the actual voltage is applied to the input

tube. This means we've increased the voltage range to 10 times what it was in position 1.

The output of this first stage feeds into a resonant circuit, which in turn feeds the second tube. It is possible to cover a wide frequency range by using plug-in coils or a wave band switch in the resonant circuits.

► This circuit still offers some problems. First, the amplification obtained over a wide frequency band is not constant, but varies according to circuit conditions. Further, the amplification obtained from a tuned circuit varies with the age of the parts, because moisture absorption and physical changes upset the inductance, capacity

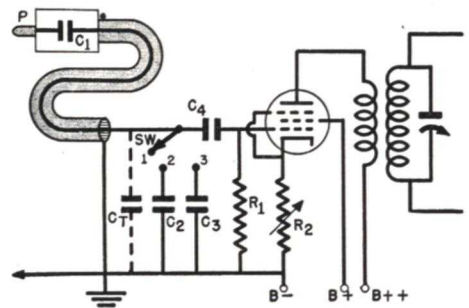

FIG. 25. The input circuit of a tuned circuit v.t.v.m. This is the basic circuit used in signal tracers.

and Q factor values. Finally, the amplification of a tube itself varies with age and with supply voltage changes.

You may wonder just what amplification has to do with the v.t.v.m. reading. The answer is—our v.t.v.m. is calibrated with the amplifier in place, and a change in amplification changes the calibration. For example, suppose our amplifier gives us an amplification of 1000. We apply a certain signal voltage and get, say, a full-scale deflection. Then the amplification changes to 800 for some reason. Now if we apply the same signal voltage, we get—not a full-scale deflection

—but only .8 of full scale. If our scale is calibrated on the basis of a 1000 amplification, obviously our reading is going to be wrong when the amplification changes to 800.

Since extreme accuracy is not needed in service work, however, many instruments of this type, known as signal tracers, have been developed and manufactured. They indicate voltage with reasonable accuracy and are very good for comparative purposes.

For example, if the voltage at the input of a radio stage is measured and found to be 2 volts and then the voltage at the output is found to be 10 volts, the gain of this particular stage would be $10 \div 2$ or 5. If there is any error in the reading of the voltage by the signal tracer, the same error will be in both these readings, and the errors will cancel. Thus, the actual gain of a radio stage can be determined with a tuned v.t.v.m., even if neither of its voltage measurements is accurate. Incidentally, for greatest accuracy in making comparative measurements of this sort, always make them with the switch *SW* set to the same range for both measurements if possible.

CALIBRATING VACUUM TUBE VOLTMETERS

A vacuum tube voltmeter must be recalibrated at frequent intervals, because of tube and voltage changes. Commercial instruments are provided with adjustments for this purpose.

In general, you calibrate a v.t.v.m. by applying a known voltage input, then adjust the instrument until it reads correctly. For d.c. vacuum tube voltmeters, ordinary dry cells are usually used as the known voltage source. The battery voltage should be measured with an accurate d.c. voltmeter while calibrating the v.t.v.m., however, as brand-new batteries may

be as much as 10% higher than their rated voltage. Naturally, any error in the calibrating voltage will cause a similar error in the v.t.v.m.

► When an a.c. vacuum tube volt-meter can be calibrated on 60 cycles, the circuits shown in Fig. 26 can be used. The accuracy depends on the standard meter—if V_M is a copper-oxide type the accuracy may only be about 5% unless the meter has been hand-calibrated or checked against a standard.

Figure 26A shows a simple circuit which can be used if the test voltage is near the full-scale reading of V_M . (As you will recall, meters are more accurate at full scale.) If the test voltage applied to the v.t.v.m. must be considerably lower than full scale of the meter, you should use the circuit of Fig. 26B. Here, rheostat R is adjusted to give V_M a nearly full-scale deflection. Then the desired test voltage is taken from voltage divider R_1 - R_2 .

The accuracy with which the test voltage is known in Fig. 26B depends on the tolerances of R_1 and R_2 , as well as on the meter V_M . Precision resistors, within 1/2% to 1% of rated values should be used.

If the meter cannot be calibrated on 60 cycles, a frequency within the range of the device must be used. A signal generator, with an amplified output, might be used as the source. The meter will have to be a thermocouple type, since that is the only

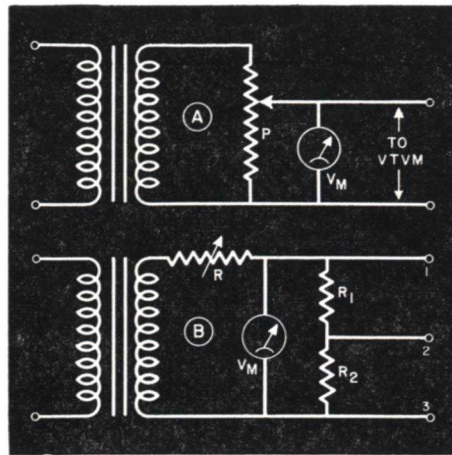

FIG. 26. Two methods of getting an a.c. voltage for calibration purposes.

standard meter having any accuracy for r.f. measurements. A circuit like Fig. 26B would be used, as the thermocouple cannot be used on very small voltage values. The resistors will have to be non-inductive (have no frequency errors) and the loading of the v.t.v.m. must be small.

Where a commercial instrument is being calibrated, the manufacturer's instructions should be carefully followed. They will usually tell you just how calibrations can be made with simple apparatus.

► Commercial instruments usually have an accuracy of from 1% to 5%. Should it be impossible to reach calibration, try a new tube in the v.t.v.m. You may have to try several tubes before finding one which will permit calibration.

The Cathode Ray Oscilloscope

Very often in radio work it would be extremely helpful if you could actually see the form of the a.c. waves you're working with. You seldom have a pure sine wave of current or voltage, you

know—the radio circuits always distort them somewhat (and sometimes a great deal). Figures 17 and 18 show some of the wave forms you might meet in a radio or television set.

Now, a.c. meters are almost always calibrated on the assumption that they are going to measure pure sine waves. If they're used to measure distorted waves, their readings will usually be incorrect. Often this doesn't make much difference—but sometimes it's very important to know just what kind of a wave form you're measuring.

If you go into radio design, you'll find it necessary to draw graphs of resonance curves, frequency response, phase shift, and many other circuit characteristics. Such curves can be drawn by making many measurements and doing a lot of laborious work—but it would certainly be a lot easier if there were an instrument that drew them for you automatically!

There is such an instrument. It will let you see the exact shape of the wave form in radio circuits. It will draw the curves mentioned above for you—and even show you changes in them as they occur.

This remarkable instrument is called the "cathode ray oscilloscope." Every radio manufacturer—every radio laboratory—considers it indispensable equipment. More and more servicemen are finding it a valuable addition to their service bench.

In the rest of this lesson, you'll learn how the cathode ray oscilloscope works.

FLUORESCENT SCREEN

Certain chemicals, when bombarded by electrons, will give off a glow of visible light. This phenomenon is known as "fluorescence." It is the principle on which fluorescent lamps work.

Now if we coat a transparent screen with these chemicals, and allow a thin beam of electrons to hit the screen, we will produce a dot of light on the screen. Further, if we can make the electron beam move over the screen in response to applied voltages, we can

make this dot of light trace out the wave form of the voltages. That's what a cathode ray oscilloscope does.

THE ELECTRON GUN

As you know, we can easily get a good supply of electrons by heating a cathode. If we put a positive plate with a hole in it near the cathode, the electrons will move toward the plate. Some will hit the plate and others will go through the hole.

We can use this fact to produce the thin beam of electrons—or "electronic

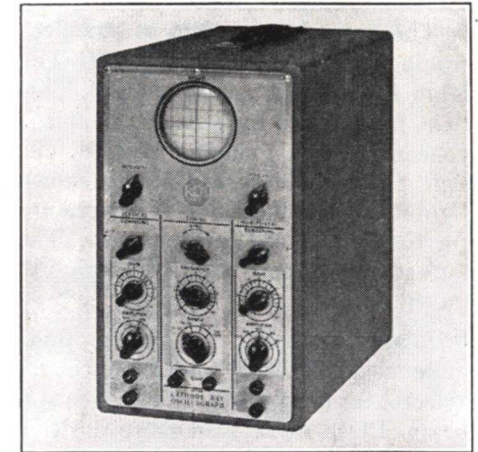

Courtesy R. C. A.

A typical c.r.o. designed for radio servicing, communications and design laboratory work.

pencil"—that we want to move over our fluorescent screen. Figure 27 shows how.

In Fig. 27A, a filament F with an oxide-coated tip emits electrons from a concentrated spot. (A special heated cathode is sometimes used in place of this filament.) These electrons are attracted toward a highly positive cylindrical plate P_1 . The filament is surrounded by another cylindrical electrode G . This electrode G is negative, and serves to concentrate the electrons and force them towards P_1 . It acts like the grid in ordinary tubes.

Since P_1 is highly positive, the electrons travel toward it at great speed and tend to go right down the length of the cylinder. Inside P_1 is a disc with a hole in it. Some electrons strike the disc and are collected by the plate, but most of them are concentrated in the middle of the cylinder and pass through the hole in the disc.

We now have a thin beam of electrons coming through the hole in the disc—the electronic pencil we've been looking for. But as this beam goes away from the disc, it tends to spread out. We need something to keep it together and focus it on the fluorescent screen.

► The optical equivalent of our electronic pencil is shown in Fig. 27B. The lamp L acts as a source of light. This light is collected by reflector R and is concentrated in a single direction. The light rays would spread out as shown by dotted lines X and Y if it were not for the lens placed in their path. The lens serves to focus the rays to a point on the screen S .

► Returning to Fig. 27A, we find that cylindrical plates P_1 and P_2 act as an "electronic lens" to focus our electron beam. Plate P_2 is even more positive than P_1 , and is carefully placed with respect to P_1 . The electrons coming through the disc hole are speeded up by the highly positive potential of P_2 . Furthermore, an electric field exists between P_2 and P_1 .^{*} This electric field collects and focuses the electron beam on the screen.

By choosing the proper P_1 and P_2 voltages, the electron beam is focused to a spot on the screen S . By varying the voltage on G , the number of electrons in the beam can be varied. In

^{*}An electric field exists between any two objects having a voltage difference. This field is made up of electrostatic lines, which may be thought of as being similar to magnetic lines of force. Actually, magnetic fields are frequently used in cathode ray tubes for focusing.

this way we can adjust the intensity of the light spot. This system is often called an "electron gun," because it "shoots" electrons at the screen.

The color of the light spot depends on the chemicals used in the screen. White, yellow, green or blue light spots may be produced by using different chemicals. At present, green is the most popular color for direct observation, and blue for photographing the image.

OBTAINING A DEFLECTION

Now that we have a spot of light produced by a pencil of electrons, we want to move the spot about on the screen and thus trace out wave forms.

This pencil of electrons consists of moving negative charges. If we place other electrical charges near this stream of electrons, we can divert its

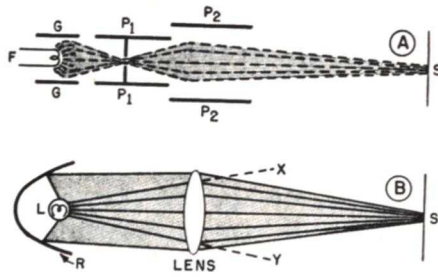

FIG. 27. Comparing an electronic focusing method with a light system.

direction of flow, so we place a flat plate on each side of the electron beam between plate P_2 and the screen, as shown in Fig. 28. We don't want a difference in potential between these plates and P_2 , as this would make the electron beam spread out, so we connect plate B to P_2 .

As long as the flat plates are at the same potential with respect to each other, the electrons will travel onward in their normal direction, toward point 1 on screen S .

However, suppose we make plate A positive with respect to plate B . The

electrons in the beam will then be attracted toward plate A , and the beam will be deflected. The electrons do not go directly to plate A —they are traveling too fast. Instead, their direction is changed so that they strike the screen at point 2 rather than at point 1.

The amount the electron beam is bent from its normal direction depends upon the voltage applied between plates A and B . Of course, if the polar-

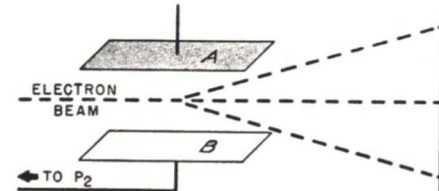

FIG. 28. How the electron beam is deflected by charged plates.

ity is reversed so that plate A is made negative with respect to B , the electrons will move in the other direction, toward point 3 on the screen.

Thus, placing these flat plates on each side of the electron beam gives us a means of making the electron stream move from point to point on the screen. The movement occurs as soon as the voltage is applied, so it will follow exactly any changes in voltage which may be impressed on the deflecting plates.

► Two sets of these plates are used—one set to move the beam up and down and the other set to move it from left to right, as shown in Fig. 29.

Imagine that the electrons are coming out of the paper toward you. If there is no voltage on the deflecting plates, the electrons will make a spot in the center of the screen, as shown in Fig. 29A.

A voltage difference between plates c and d will cause a vertical (up and down) deflection, so these plates are called the *vertical deflecting plates*. If the voltage changes rapidly enough,

a vertical line will be formed, as shown in Fig. 29B.

Plates a and b cause a horizontal deflection, so are called the *horizontal deflecting plates*. An a.c. voltage between these plates will form a horizontal line, as in Fig. 29C.

Any a.c. above 20 cycles per second will produce these lines of light, because of the persistence of human vision. The eye continues to see light for a fraction of a second after it has been cut off, so the rapidly moving spot "blends" into a line.

Now that we can move the beam about on the screen, how do we get a complete picture of the wave form?

SWEEP VOLTAGE

Suppose we apply a sine wave voltage to plates $c-d$, with no voltage on plates $a-b$. The spot of light starts at

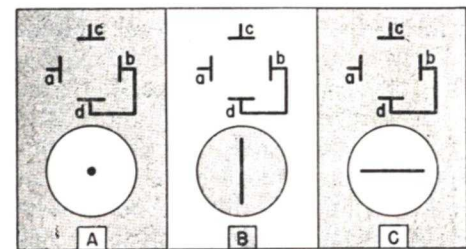

FIG. 29. By applying an a.c. voltage to one set of plates at a time, we change from a spot of light to either a vertical or horizontal line of light.

the no-voltage position. (Fig. 29A), goes up until the voltage reaches a peak, goes down until the voltage reaches a negative peak, and repeats this motion as long as the voltage is applied. This gives us the vertical line shown in Fig. 29B, but it doesn't show us what the wave form looks like.

What we want is some means of making the spot move at a regular speed sideways at the same time it is moving up and down. Then the beam can trace out the wave form. Now we

know how to make the spot move sideways—we apply a voltage to plates *a-b*. We call such a voltage a “sweep voltage” when we apply it to a cathode ray oscilloscope, because it sweeps the spot back and forth.

You might think of applying the sine voltage to both sets of plates at the same time. However, this would give us a tilted line or a series of circular patterns instead of a picture of the wave we are interested in.

We want a voltage which will move the spot sideways until one cycle has been traced out, then instantly will sweep the spot back to the starting point to begin the process all over again.

Therefore, if the sweep voltage is made to have the special “saw tooth” shape shown in Fig. 30, the spot will be moved in such a way that we can see how the wave that we are studying looks; no other sweep voltage shape will allow this. The saw-tooth voltage increases linearly from *A* to *B* (see Fig. 30), then snaps back at once to *C*; the cycle is repeated from *C* to *D* to *E*.

Sweep Generator. We can get this special wave from a circuit like that in Fig. 31. You recall that a condenser-resistor combination has a time constant—it takes time for the condenser to reach a full charge when a voltage is applied through a resistor. The condenser voltage builds up gradually from zero, somewhat like the curve *a-b-c* of Fig. 31*B*.

Battery *B*₁ charges condenser *C* through the resistance *R* in Fig. 31*A*.

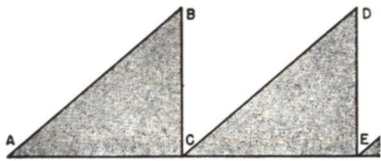

FIG. 30. The sweep voltage must increase steadily and linearly to a maximum, then drop back quickly to the starting level.

If it were not for tube *VT*, the condenser would charge up to the battery voltage and nothing else would happen. However, tube *VT* is a special gas tube (like a thyratron) in which no plate current will flow until a certain critical plate voltage is applied. Then the tube suddenly begins conducting.

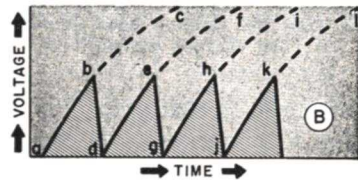
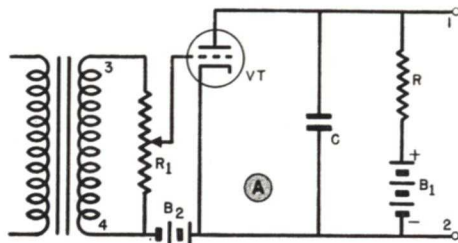

FIG. 31. How a sweep generator produces the desired sweep voltage.

Because of the gas, it becomes practically a short circuit.

As the condenser starts charging through *R*, its voltage follows the path *a-b-c*. When *b* is reached, the condenser voltage is sufficient to make *VT* conduct. Condenser *C* then discharges immediately through the tube, so the condenser voltage drops to zero, or from *b* to *d*. This means there is no longer any plate voltage on *VT*, so the tube stops conducting.

Battery *B*₁ again tries to charge the condenser through *R*, along curve *d-e-f*. At *e*, *VT* again breaks down and the cycle is repeated. Thus the actual voltage across the condenser follows the *a-b-d-e-g-h-j-k* curve and has approximately the desired shape.

We want the *a-b*, *d-e*, *g-h* and *j-k* portions of the condenser voltage to be as straight as possible. This means the voltage source must be high enough

to make the tube *VT* act quickly, which will keep these points on the more nearly straight part of the condenser charging curve.

The frequency of this wave can be varied by changing the resistance of *R* or the capacity of *C*. This changes the time constant, and hence the frequency with which *VT* breaks down.

We can take this saw-tooth voltage off the condenser from terminals 1 and 2. A blocking condenser is usually used, feeding into a resistor, so the following circuits will not affect the shape of the sweep voltage. As you've learned, feeding a pulsating d.c. (which our sawtooth wave is) through a blocking condenser gives an a.c. input to the next circuit.

Using the Sweep Voltage. When we apply only the sweep voltage to the horizontal deflecting plates, the line in Fig. 29*C* is produced. The spot moves at a steady rate from left to right, then snaps back to the left to repeat the trace.

Suppose we now apply a sine wave voltage to the vertical plates, starting this wave and the sweep at the same time. Figure 32 shows what happens. The voltage wave shown at *A* is the sweep voltage, while *B* represents the voltage applied to the vertical deflecting plates. The combination of these two voltages produces the wave *C* on the screen.

The spot will normally be in the center of the screen, about at point *e*. As the sweep voltage now has an a.c. form because of the blocking condenser through which it was fed, points 1 to 9 of *A* represent negative potentials on the right-hand horizontal deflecting plate which corresponds to plate *b* of Fig. 29. Points 9 to 17 represent positive voltages on this plate (with respect to plate *a*).

Therefore, when the sweep starts at point 1, plate *b* is negative, so the spot

moves toward plate *a* or to the extreme left. This is point *a* in Fig. 32*C*. The effect of the changing sweep voltage is to make the right-hand plate less negative, then positive, so the spot is moved to the right.

When the sweep voltage is at position 1, the vertical voltage is at position 2 (no voltage). The spot is therefore far over to the left at position *a*. When the sweep voltage increases to 3, the vertical voltage increases to 4. Now the sweep voltage moves the spot horizontally, and the vertical voltage moves it vertically at the same time.

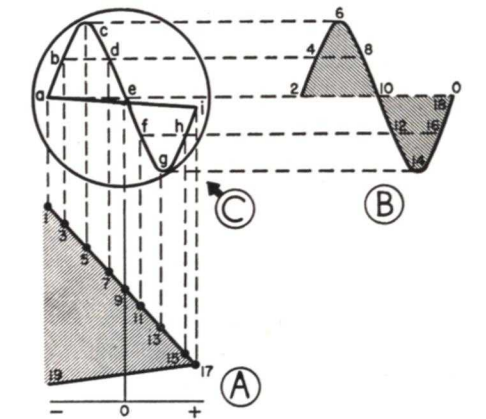

FIG. 32. How applying the sweep and a sine wave causes the sine wave to be reproduced.

The combined effect of the two voltages moves the spot to position *b*, (where lines drawn from the two voltages intersect). Similarly, voltages at 5 and 6 move the spot to *c*, and so on. When the sweep voltage reaches 17, the condenser discharges, and the sweep voltage drops swiftly to point 19, then starts to build up again and repeats the whole process.

These voltages move the spot so quickly that we see a line, instead of moving spots, on the screen. The line from *i* to *a* on the screen is produced by the swift drop in sweep voltage from 17 to 19.

Thus, the sweep voltage has changed the screen trace of the voltage on the vertical plates from a vertical line to a spread-out "picture" which is exactly like the applied wave. Regardless of the shape or distortion of the wave applied to the vertical plates, it will be reproduced exactly.

SYNCHRONIZATION

We started the sweep at the same time as the sine wave and had it finish at the same time. Hence, both are of the same frequency.

These frequencies must be "locked" together to prevent the cathode ray pattern from drifting about. We do this by feeding some of the input signal to the thyatron tube grid at points 3 and 4 of Fig. 31A. The sweep generator is first adjusted to a frequency just

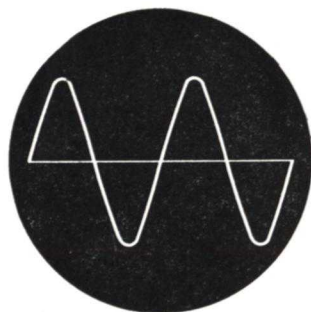

FIG. 33. When the sweep frequency is half the vertical deflecting frequency, two cycles will be produced.

slightly below the right frequency. Then, the signals applied to the thyatron swing the grid positive, making the tube conductive and discharging the condenser at just the right moment to lock the sweep in step with the incoming wave. In other words, this forces the sweep to "jump" to the right frequency. This is called synchronization. This control will not work if the sweep frequency is too far from the right value. It is necessary to

adjust the sweep frequency below the right value so the sweep won't ever discharge by itself and thus get out of step with the synchronizing grid voltage.

It is also possible to make the sweep lock at a frequency which is an exact fraction of the applied voltage frequency. This gives two or more cycles on the screen, as shown in Fig. 33. You will learn more about this in another lesson.

FREQUENCY RANGE

Very high frequencies can be applied directly to the deflection plates of a properly designed c.r.o. However, about 30 volts are needed to give a deflection of about 1 inch on the screen. This means that voltages of 75 to 100 volts or so may be required for a reasonably large figure on the screen—far higher than are usually available. For this reason, an amplifier for the input to the vertical plates is built into the c.r.o.

This is usually a resistance-coupled amplifier of from 1 to 3 stages, designed to have a wide frequency response. Even so, the amplifier limits the frequency range. Oscilloscopes made for radio service work are mostly used at audio frequencies, and so have a range up to about 100 kc. Special amplifiers are used in laboratories and in television work to gain a wide frequency range.

A volume control is used on the amplifier so that the deflection can be adjusted within the limits of the screen.

A TYPICAL C.R.O.

Figure 34 shows a block diagram of a typical oscilloscope designed for service work. Let's go through the sections starting with the c.r.o. tube.

The C.R.O. Tube. The tube is

shown here as you would find it on a schematic diagram. Starting from the filament, we have a cathode, the element *G*, the plate *P*₁ (shown here with a grid symbol), plate *P*₂, the vertical deflecting plates and the horizontal deflecting plates.

The cathode connects to the junction of *R*₃ and *R*₄. The grid element *G* connects to the slider of *R*₃, which provides a variable negative bias used to control the intensity of the spot on the screen.

Plate *P*₁ connects to the slider of

of the earth.

Vertical Amplifier. The voltage being checked is fed in at the terminals *V* at the left. Switch *SW*₁ can be set to feed this signal directly to the c.r.o. through *C*₁, or into the vertical amplifier. This amplifier is designed for frequencies up to 100 kc. in most service instruments. It has a volume or gain control.

Horizontal Amplifier. The signal fed to the horizontal deflecting plates may be an external signal or may come from the sweep generator. The switches

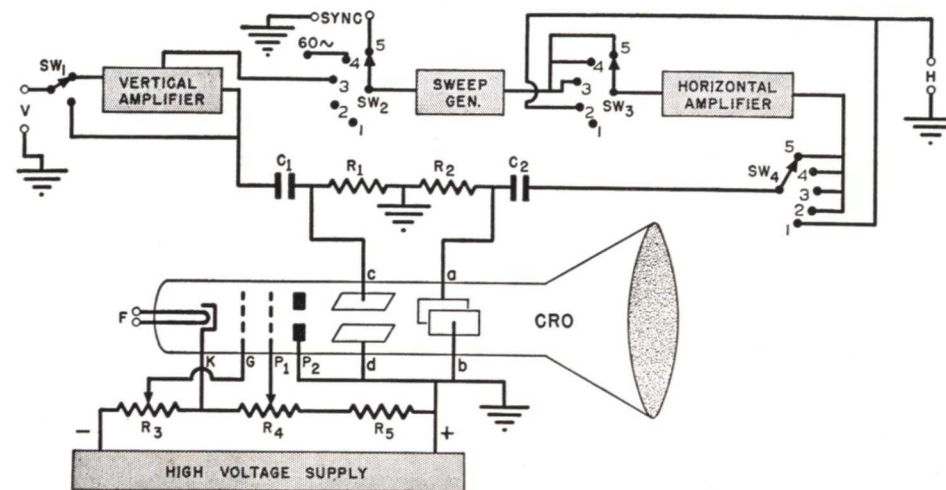

FIG. 34. A block diagram of the "innards" of a typical c.r.o.

*R*₄, which provides a variable positive voltage, used to focus the spot accurately on the screen. Plate *P*₂ connects to the positive supply terminal, so that the maximum voltage difference exists between *P*₂ and the cathode. The power supply furnishes 1000 volts or more for the tube.

One plate of each pair of deflecting plates is connected to *P*₂. The application of a signal requires a ground here, which means the positive power supply terminal is grounded instead of the negative as in radio sets. The position of the ground does not affect the power supply in any way, as it is independent

*SW*₂, *SW*₃ and *SW*₄ are ganged together, on the same shaft, and control the signal paths to the horizontal plates.

► In position 1, an external signal is fed in at the *H* terminals at the right, and passes through position 1 of switch *SW*₄, then through *C*₂ to the c.r.o. tube.

► In position 2, the external signal from terminals *H* comes through *SW*₃ into the horizontal amplifier, and from there through *SW*₄ to the c.r.o. tube. This provides amplification, controllable by the gain control on this amplifier.

► Positions 3, 4 and 5 feed the sweep

generator signal through SW_3 to the horizontal amplifier and from there through SW_4 to the c.r.o. tube. These three positions provide varying sources of synchronizing voltage for the sweep generator.

► In position 3, part of the signal from the vertical amplifier is fed through SW_2 to the sweep input. This is the most used position of these switches, as this provides a "lock" with the incoming signal for the vertical plates.

► Position 4 feeds 60 cycle a.c. into the sweep generator, permitting a lock with the power line frequency.

► Position 5 connects the sweep to external terminals SYNC, so that an external frequency source can be used to control the sweep.

Centering Controls. It is impossible to locate the tube elements in every tube so as to get the spot in the exact center of the screen when no deflecting voltages are applied. However, this can be corrected electrically as shown in Fig. 35.

Instead of connecting P_2 and deflecting plates b and d to the maximum positive point as in Fig. 34, this connection is now made to the junction of added resistors R_6 and R_7 .

Resistors R_1 and R_2 are now grounded for a.c. through condensers C_3 and C_4 and their d.c. paths return to potentiometers R_8 and R_9 .

Resistors R_6 and R_7 are now part of the voltage divider, and the same voltage exists across R_8 and R_9 , which are in parallel. When the sliders on R_8 and R_9 are centered, the arms are at the same potential as the R_6 - R_7 junction. There is now no difference in po-

tential between the pairs of deflecting plates.

Adjusting R_8 will make plate c either positive or negative with respect to d , depending on the direction of movement from the center of the control.

Similarly R_9 will bias plate a with

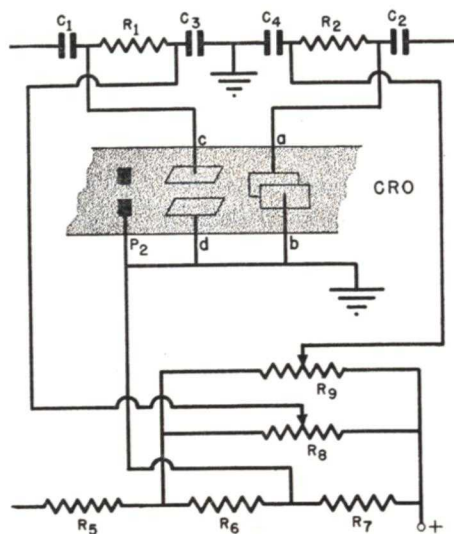

FIG. 35. Centering controls correct for an off-center spot of light.

respect to b . Thus it is possible to move the spot up or down or to the right or left, until it is exactly centered. These controls are found on commercial instruments, and are called the centering controls.

After the beam is centered and focused, and the intensity is adjusted to reasonable brilliancy, we can apply the external signals and the sweep voltage (if used) through C_1 and C_2 to the c.r.o. tube.

Lesson Questions

Be sure to number your Answer Sheet 29FR-2.

Place your Student Number on every Answer Sheet.

Send in your set of answers for this lesson immediately after you finish them, as instructed in the Study Schedule. This will give you the greatest possible benefit from our speedy personal grading service.

1. What ohms-per-volt sensitivity is commonly obtained on the basic range of d.c. type vacuum tube voltmeters?
1000 OHMS PER VOLT.
2. What is the purpose of R_3 and C in Fig. 3? *ACT AS AN H.C. FILTER*
3. What is the purpose of R_2 in Fig. 3? *SELF BIAS RESISTOR, TENDS TO KEEP THE PLATE MORE CONSTANT.*
4. What is the purpose of R_7 in Fig. 10? *TO GET GREATER STABILITY AND HIGHER SENSITIVITY*
5. Suppose an a.c. type v.t.v.m. is connected across a tuned circuit. How can you compensate for the capacity loading which detunes the circuit? *THROUGH THE VTVM TUBE*
6. Why do we get an error when we try to measure a distorted wave with an a.c. type v.t.v.m.? *BECAUSE THE WAVE WILL NOT BE A PURE SINE WAVE WILL HAVE SOME AVERAGE TO RMS RELATIONSHIP*
7. What determines the accuracy of a slide-back v.t.v.m. when properly adjusted? *THE LINEARITY OF THE TUBE*
8. What are the advantages of using tuned circuits in signal tracers? *ONLY MEASURES VOLTAGES WITH REASONABLE ACCURACY*
9. Why must the sweep voltage have a saw-tooth wave shape? *TO MAKE IT COMPLETELY LINEAR*
10. When synchronizing the sweep of a c.r.o. so as to make the pattern "lock in," is the sweep frequency adjusted above, below, or the same as the synchronizing signal frequency?



“WISHERS” AND “DOERS”

How often have you said, “I wish I had more money?” Thousands of times, possibly. But do you realize that if you are living in a town of, let us say, 5000 inhabitants, there are exactly 4999 others in your town who are saying exactly the same thing?

And yet, of these 5000 “wishers,” only about 100 are going to do something about it. The others are going to continue being “wishers.”

Now, any man who shows enough “get-up-and-go” spirit to undertake this Course proves that he is not a mere “wisher.” When you enrolled, you showed that you wanted to be a “go-getter.” Your job now is to keep going forward on the road you have mapped out for yourself.

Every lesson in this Course, every radio job you work hard to get, is a step along this road. So don't let yourself wish that the lessons were easier, or that you could become successful without studying, or that radio jobs would come looking for you. Stay out of the class of the “wisher,” and stay in the class of the “doer.”

J.C. Smith