

**HOW CONE-TYPE
LOUDSPEAKERS WORK**

27FR-2

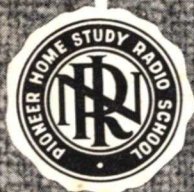

NATIONAL RADIO INSTITUTE

WASHINGTON, D. C.

ESTABLISHED 1914

STUDY SCHEDULE No. 27

For each study step, read the assigned pages first at your usual speed, then reread slowly one or more times. Finish with one quick reading to fix the important facts firmly in your mind, then answer the Lesson Questions specified for that step. Study each other step in this same way.

- 1. Cone Loudspeakers; Dynamic Loudspeaker Design**
Problems - - - - - Pages 1-7
Shape and Size of Cones; Cone Mountings; Cones of Dynamic Loudspeakers; "Tweeter" Cones; The Spider; Mechanical Resonance in Dynamic Loudspeakers; Piston Action; Double Voice Coils. Answer Lesson Questions 1, 2, 3 and 4.
- 2. Baffles; Box Baffles** - - - - - Pages 7-16
Purpose of a Baffle; Irregular-Shaped Baffles; Mechanical Characteristics of Box Baffles; Equivalent Electrical Circuit of a Loudspeaker-Baffle Assembly; Natural Resonant Frequency; Infinite Baffles; Standing Waves; Bass-Reinforcing Box Baffles; Stromberg-Carlson Acoustical Labyrinth; Special RCA Box Baffles; Acoustic Clarifiers. Answer Lesson Questions 5, 6, 7 and 8.
- 3. Sound Diffusers; Horn-Shaped Baffles** - - - - - Pages 16-19
Polar Radiation Patterns; Deflecting Vanes; Tweeter and Woofer Loudspeakers; Types of Horn-Shaped Baffles; Loudspeaker Efficiencies; Exponential Horns. Answer Lesson Question 9.
- 4. Loudspeaker Impedance** - - - - - Pages 19-24
Mechanical Inductance, Capacitance and Resistance of a Loudspeaker; Electrical Impedance of Loudspeaker; Determining Loudspeaker Impedance; Matching, Typical Loudspeaker Matching Circuits; Replacement of Output Transformers. Give special attention to the last three subjects here, because they are important practical applications of the theoretical information in the first part of this study step.
- 5. Field Coil Connections; Acoustical Problems of High-Fidelity Reproduction** - - - - - Pages 24-28
Use of Field Coil as Filter Choke; Types of Field Coil Connections; Separate Field Supplies; Elimination of Hum; Shading Ring; Hum-Bucking Coil; High-Fidelity Two-Loudspeaker Systems and their Response Curves; Room Acoustics; Loudspeaker Replacement Hints. Answer Lesson Question 10.
- 6. Mail Your Answers for this Lesson to N. R. I. for Grading.**
- 7. Start Studying the Next Lesson.**

COPYRIGHT 1938 BY NATIONAL RADIO INSTITUTE, WASHINGTON, D. C.

1950 Edition

NPC8M1149

Printed in U. S. A.

HOW CONE-TYPE LOUDSPEAKERS WORK

Cone Loudspeakers

LOUNDSPEAKERS of the horn type, having the required wide frequency range for high-fidelity reproduction, are too bulky for use with the average home radio receiver even when curled to occupy a minimum of space. Engineers recognized this fact soon after loudspeakers first came into use, and eliminated the horn entirely by increasing the size of the diaphragm and setting a large amount of air directly into motion.

Since a large, flat diaphragm will buckle or bend readily even when driven from its center, loudspeaker engineers shaped this diaphragm in the form of a cone, attaching the driving unit to its apex or point. The outer edges of the cone are free to move, being held in alignment by a soft leather ring or washer cemented to the edges of the cone and supported by a circular steel frame. The entire cone moves in and out in unison with the driving unit, at least for low frequencies.

In the early days of radio, a cone as large as 36 inches in diameter was quite common, being used to secure good low-frequency output, but the high-frequency response of these cones was irregular. Today cones are generally from 6 to 14 inches in diameter; because loudspeaker engineers now have a better understanding of the exact operation of a cone loudspeaker, remarkably flat response characteristics are being secured.

The cone arrangement of a typical cone loudspeaker is shown in Fig. 1. Observe that the frame of the cone is held against a flat surface known as a baffle, which may be either of wood,

plywood, fiber board or other sound-absorbing material in which a circular hole the same diameter as the cone has been cut. This baffle board serves to prevent sound waves produced at the rear of the cone from interfering with sounds produced at the front of the cone. For the present we will assume that the baffle is so large that no interference or can-

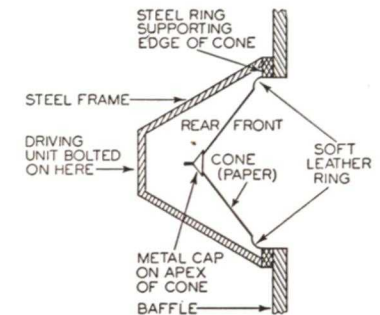

FIG. 1. Cross-section view of a cone loudspeaker and its supporting structure, as mounted on a wood baffle. Driving unit is not shown.

cellation of sound can take place; later in this text-book we will consider baffle design in detail.

In general, cone loudspeakers will be found with balanced armature magnetic driving units, with electrodynamic or permanent magnet dynamic driving units, and with crystal driving units. A number of typical cone loudspeakers are shown in Fig. 2.

The unit in Fig. 2A is typical of cone loudspeakers using a balanced armature magnetic driving unit. The apex or point of the cone is driven by a metal extension arm or lever attached to the vibrating armature. In many cone loudspeakers, the mechanical lever system is so arranged that it provides mechanical amplification of the cone movement;

in other words, the apex of the cone may move twice or three times as far as the point on the armature to which the lever is attached. Even with this mechanical lever arrangement, the movement of the cone is definitely limited by the movement of the balanced armature between the pole pieces. Magnetic loudspeaker units of this type ordinarily will not handle much more than 2 watts of electrical input power.

sume this to be an electrodynamic unit, with the permanent magnetic flux being produced by direct current flowing through the field coil. If there are no additional leads, the unit is of the permanent magnet dynamic type.

The cone unit alone of a dynamic loudspeaker is shown in Fig. 2D. Observe that the voice coil is attached directly to the cone. The size of the voice coil leads has been exaggerated

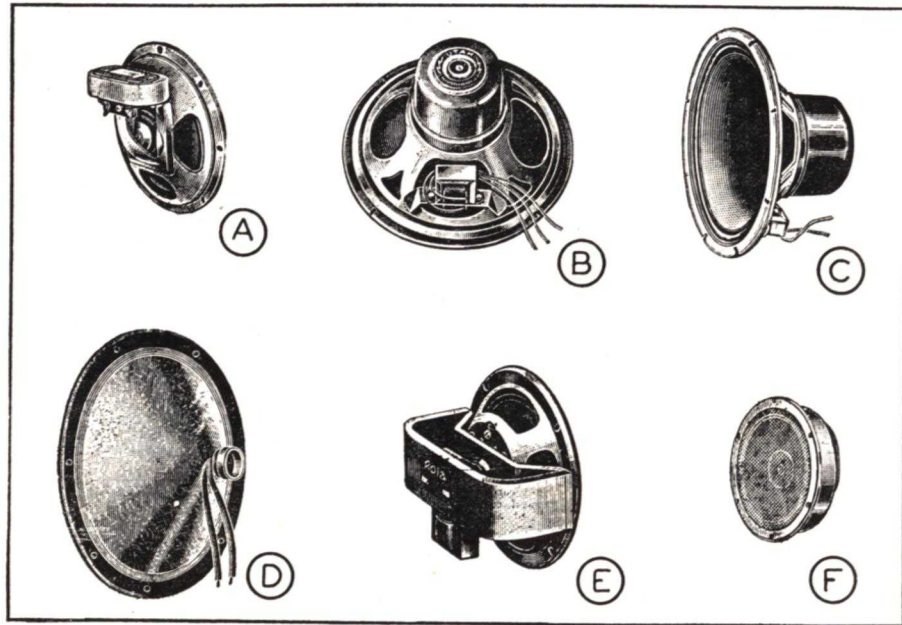

FIG. 2. Typical cone loudspeaker units.

In Figs. 2B and 2C are two views of a representative dynamic cone loudspeaker. The transformer which matches the voice coil impedance to the output impedance of the power stage of the receiver can be seen mounted directly on the loudspeaker frame, as is the usual practice. If, in addition to the leads coming from the matching transformer, there are two or three more leads coming from the pot or cylindrical housing at the back of the loudspeaker, we can as-

sume this to be an electrodynamic unit, with the permanent magnetic flux being produced by direct current flowing through the field coil. If there are no additional leads, the unit is of the permanent magnet dynamic type. The cone unit alone of a dynamic loudspeaker is shown in Fig. 2D. Observe that the voice coil is attached directly to the cone. The size of the voice coil leads has been exaggerated

of cones which have become damaged or have deteriorated through continuous use.

A permanent magnet dynamic cone loudspeaker is shown in Fig. 2E. Here the large U-shaped steel bar serves as the permanent magnet. Both tips of this bar are magnetized with the same polarity, the center being of opposite polarity. The soft iron central core for the voice coil is attached to the center of the permanent magnet, and is therefore opposite in polarity to the soft iron pole piece which is in contact with the ends of the U-shaped permanent magnet.

A crystal cone loudspeaker unit is shown in Fig. 2F. Ordinarily this will be found with a small, light cone about 5 inches in diameter. Crystal loudspeakers are often called "tweeters," and are used to reproduce the higher audio frequencies, in conjunction with an ordinary loudspeaker designed to reproduce the bass notes.

Dynamic Loudspeaker Design Problems

The Spider. One important part of a dynamic cone loudspeaker has not yet been taken up, simply because it does not appear in ordinary loudspeaker illustrations; this part is the *spider*, a springy sheet of fiber or bakelite material cut as shown in Figs. 3A and 3B. The spider serves two purposes, that of *centering the voice coil* with respect to the soft iron core and pole pieces, and that of *returning the voice coil and cone to a normal position* when the driving force drops to zero.

In horn loudspeakers the back of the driving unit is completely enclosed and the air in the enclosed rear chamber provides the springiness required to return the diaphragm to its normal position; in dynamic cone

loudspeakers, however, this back air chamber is usually absent. The ordinary cone has little natural springiness because of the nature of its mounting, and therefore a spring must be used to provide the restoring action which is essential to correct loudspeaker operation. This spring is called a *spider*.

The *internal spider* unit shown in Fig. 3A is cemented inside the voice coil at the point where it joins the cone. The center part of the spider is fastened to the cylindrical iron core

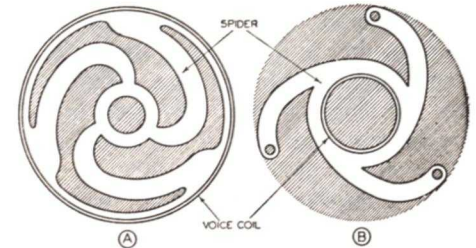

FIG. 3. Typical spiders used in cone dynamic loudspeakers to keep the cone and voice coil assembly properly centered with respect to the central iron core. That at A is for the front of the cone, and the form shown at B is for mounting on the back of the cone, around the voice coil. Spiders also provide a restoring spring action for the cone. Spiders of the type shown at B, which must surround the voice coil, will be considerably larger than those at A, which fit inside the voice coil.

inside the voice coil but is held away from the core by a bushing. A machine screw passing through the center hole of the spider and the bushing firmly anchors the spider. When this screw is loosened, the spider, voice coil and cone assembly can be moved a small amount in any direction to permit exact centering of the voice coil.

Sometimes the spider is of the shape shown in Fig. 3B, and is cemented to the outside of the voice coil at the point where it joins the cone. Three machine screws, one for each leg of the spider, hold it firmly against the outside housing or pot of the loudspeaker. Occasionally you will find an *external spider* of this

type made from webbed cloth which has been treated with bakelite varnish to give it springiness.

Since dynamic loudspeakers are by far the most common of any types in use today, it will be worth while to consider in detail a number of their peculiar design features which are not apparent at first sight. A great many design problems must be solved in connection with the driving unit, the cone and the spider in order to secure good frequency response and high efficiency.

You already know that the force acting upon the cone of a dynamic loudspeaker is determined by the current flowing through the voice coil, by the length of the wire used in the voice coil, and by the flux density in the vicinity of the voice coil. Before we can determine the effectiveness of this force in producing air velocity or sound, however, we must analyze the characteristics of our moving or vibrating system. Referring to Fig. 4A, we can see that the voice coil has a certain amount of mass, which we can consider as mechanical inductance L_V . The cone has a mass which can be considered as mechanical inductance L_C , and the air which is moved directly by the cone also has a certain amount of mass, which can be represented as mechanical inductance L_A . The spider provides most of the springiness or compliance, and this can be represented as mechanical capacitance C_S . The opposition offered by air particles to the movement of the diaphragm can likewise be represented as mechanical resistance R_A . Experiments have shown that all these parts can be considered as acting in series, as shown in Fig. 4B. Note the absence of a mechanical capacitance shunting R_A ; there being no air pocket in front of the cone, the dynamic loudspeaker does

not have this capacitance which in a horn unit reduces the high audio frequency output. The grille cloth usually found in front of a dynamic loudspeaker is loosely woven, so that sound waves can travel through it readily at all audio frequencies.

Mechanical Resonance in Dynamic Loudspeakers. From our knowledge of electrical circuits like that shown in Fig. 4B, we know that mechanical resonance will occur in our vibrating system when the combined mechani-

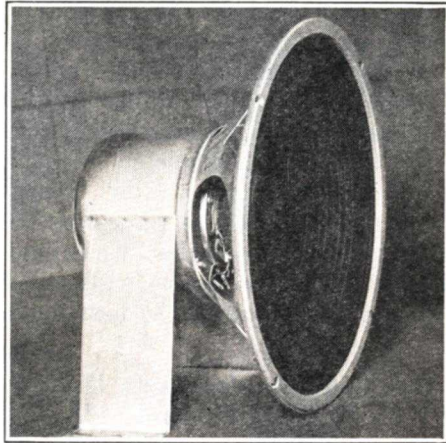

Courtesy Utah Radio Products Co.

The external spider, surrounding the cone end of the voice coil, can be seen on this photograph of a Utah dynamic loudspeaker.

cal reactances of L_V , L_C , and L_A are exactly equal to the reactance of C_S . In a dynamic loudspeaker the spider (or whatever mechanical restoring spring action is used) has a high compliance, and hence the mechanical capacity is high. High values of capacity acting with high values of inductance make mechanical resonance occur at low frequencies in dynamic cone loudspeakers. In the average dynamic cone loudspeaker unit, resonance occurs below 100 cycles. This resonant action is usually utilized to reinforce the response of the loudspeaker at bass frequencies.

At resonance the entire input power is utilized in producing useful sounds; unless the cone is properly loaded by means of a suitable baffle, the movements of the cone will be excessive at resonance, resulting in distortion or even in damage to the voice coil, and particularly to its spider.

Piston Action. At frequencies above resonance, the circuit acts as a mechanical inductance in series with the mechanical resistance, which means that the driving force has only

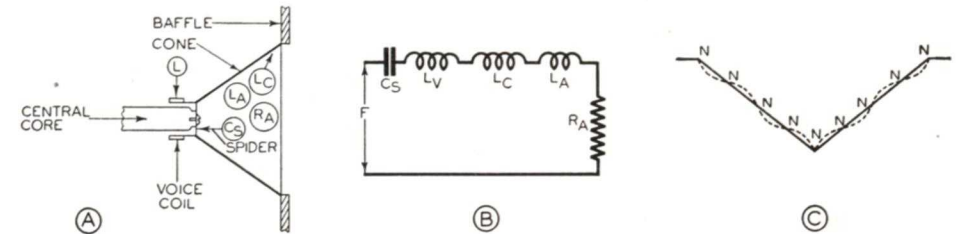

FIG. 4. A cone loudspeaker like that at A can be studied by means of an equivalent acoustical circuit like that at B. The diagram at C illustrates how a cone itself can vibrate at high audio frequencies; the points marked N represent nodes, which are points at which there is no vibration. The dotted line curve represents the maximum amplitude of the vibration at any other point along the cone.

mass and resistance to oppose it. You know that inductive reactance increases with frequency, and consequently our mass reactance in this mechanical system would likewise increase if it were not for the fact that the mechanical resistance R_A increases also and compensates for the increased mass to a certain extent. (Actually, tests have shown that the air resistance R_A increases uniformly with frequency up to the point where the diameter of the cone becomes one-half wavelength.) This essentially flat or uniform output response is obtained up to the frequency where the cone begins to vibrate with nodes and peaks as shown in Fig. 4C. Under this condition the cone is no longer acting upon the air in the manner of a piston, but is itself vibrating. Once this condition is reached, the mechanical resistance R_A stays essentially constant, while the mass reactance of

the unit decreases with increasing frequency. Although this would tend to give greater output at high frequencies, unfortunately the cone will vibrate as indicated in Fig. 4C only for certain frequencies. This means that the high-frequency response of the loudspeaker will have many irregular peaks rather than the desired uniform response.

In a 12-inch cone (the diameter of the free edge), this change from piston action to vibrating cone action

takes place at about 750 cycles. For an 8-inch cone the change occurs at about 1,000 cycles, and for smaller-diameter cones it occurs at correspondingly higher frequencies.

Since pure piston action is desirable in the cone of a dynamic loudspeaker in order to secure a flatter frequency response, the loudspeaker designer uses a scheme which automatically reduces the diameter of the cone for the higher frequencies. One such scheme involves placing a number of concentric corrugations in the cone, as shown in Fig. 5A; the result is that at low frequencies the entire cone will be effective, with edge 1 serving as the free edge. At slightly higher frequencies the free edge of the cone will move inward to the corrugation at point 2; under this condition only that part of the cone between corrugation 2 and the voice coil will be in motion. At increasingly higher

frequencies, the effective cone diameter becomes increasingly less; at the highest frequency, corrugation 3 becomes the free edge.

A typical dynamic cone loudspeaker having corrugations in the

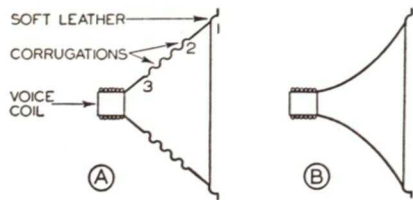

FIG. 5. Two methods of improving the high frequency response of a cone loudspeaker are illustrated here.

cone to reduce self-vibration and thereby improve the high-frequency response is shown in Fig. 6.

Another scheme for increasing efficiency by securing pure piston action involves using a special shape of cone, the free edge of which will automatically shift towards the voice coil as the audio frequency increases. A suitable shape for accomplishing this result is shown in Fig. 5B; since the curve of this cone corresponds to that of a parabola (a special geometric curve), it is often called a *para-curve* or a *curvilinear* diaphragm.

A third scheme involves gradual thinning out of the cone material from the voice coil toward the free edge. Each of these schemes gives a reasonably flat frequency response up to about 3,000 cycles, with decreased and somewhat non-uniform output at higher frequencies. This does not mean, however, that no high-frequency output is obtained; actually the high-frequency output can be quite satisfactory for ordinary radio receiver requirements, but for more nearly perfect reproduction, a second loudspeaker, designed specifically for uniform high-frequency reproduction, should be considered.

Double Voice Coils. Even if we could limit cone movement to that region immediately in the vicinity of the voice coil at high frequencies, in order to secure the desired piston action, the voice coil itself would still have too much mass for perfect results. This mass can be reduced by careful design of the voice coil in order to keep its weight at a minimum, and this in turn extends the upper frequency range of the loud-

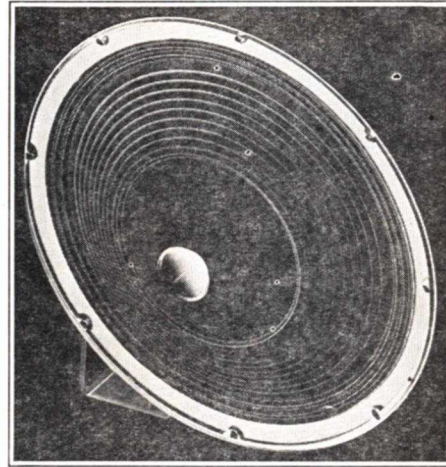

FIG. 6. The corrugations which serve to reduce the effective diameter of the cone at higher frequencies are clearly visible in this photograph of an RCA Victor dynamic cone loudspeaker unit.

speaker a certain amount. To further extend this range, two voice coils are sometimes used together, as illustrated in Fig. 7. The coils are connected by an elastic coupling band which can be represented as C_1 . Coil L_1 has considerably greater mass than L_2 . At low frequencies the mechanical capacitance C_1 is ineffective (the elastic coupling does not bend), and the driving forces produced by both coils act upon the cone. At high frequencies only the smaller coil is capable of moving at the high rate of vibration involved, and the elastic coupling at C_1 allows this coil alone to drive the cone, while L_1 remains

essentially fixed. In this way the cone can be made to produce uniform outputs up to about 6,000 cycles, with lowered output at higher frequencies than this. Coils L_1 and L_2 each have their own leads, being externally con-

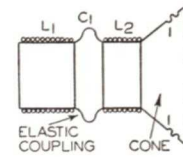

FIG. 7. The double voice coil construction shown here is sometimes used to reduce the effective mass of the vibrating system at high frequencies and thus improve the high-frequency response.

nected together in series. L_1 , the heavier coil, is ordinarily shunted with a condenser whose value is such that high-frequency currents will be by-passed around it and will flow only through L_2 , where they will produce a useful mechanical force.

Baffles

When the voice coil pushes the cone of a dynamic loudspeaker forward or away from the pot, the air in front of the cone is compressed or made heavy, while the air at the rear of the cone is simultaneously thinned out or made rare, as indicated in Fig. 8A. Those particles of air which are compressed will exert force on adjacent air particles, transferring this compressed condition to nearby air particles at the speed of sound, which is about 1,089 feet per second. It is a natural tendency for these compressed air particles to move outward in all directions, with many of them moving around the edges of the cone to the rear. If the air at the rear of the cone is rarefied at the time when compressed air particles arrive, the particles rush to the rear to equalize the air pressure, and this rush of particles in turn brings more compressed air particles from the front to the rear. The result is cancellation of useful sound, since sound is produced the

instant that air is compressed at the front of the cone.

To limit this natural tendency for air to avoid doing useful work, we can place around the loudspeaker a baffle made up of a square or circular board having cut in it a hole equal to the diameter of the cone. A baffle such as this is indicated in Fig. 8B; we can immediately see that air particles which are compressed in front of the cone must travel completely around the baffle before they can reach the back of the cone. It takes a certain amount of time for this compressed air condition to be transferred from

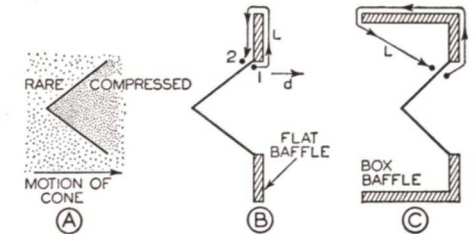

FIG. 8. The shortest sound wave path from the front of a cone around the baffle to the rear must be at least one-half the wavelength of the lowest sound frequency to be reproduced if cancellation of sound waves is to be avoided.

point 1 around the baffle to point 2, and this time should be made long enough to allow the cone to begin compressing the air at the rear on its backward movement. Under this condition there is practically no cancellation of compressed air by rarefied air, and a considerably greater amount of useful sound is radiated by the front of the loudspeaker.

Let us assume that the cone is moving in and out in a sine wave manner. When the cone is farthest forward, compression of air at point 1 will be a maximum. This compressed air will take the shortest path to point 2, where a rarefied condition exists at this moment; naturally this will be the path L around the baffle. The time

taken for air movement along this path will be equal to the length of the path divided by the speed of sound; if this time is such that the cone has gone through a complete half cycle by the time the compressed air reaches point 2, then the cone will be compressing air at point 2, the compressed air from that point will meet air which is equally compressed, and no cancellation will take place. As a result, the compressed air at the front will be forced to move in the desired

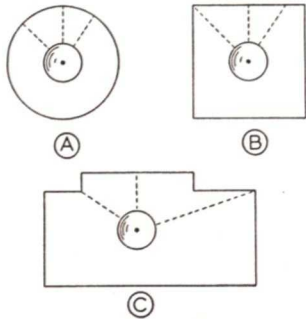

FIG. 9. The irregular-shaped flat baffle at C gives more uniform frequency response than either the circular baffle at A or the square baffle at B. Dotted lines indicate possible sound wave paths.

forward direction. The path length required to prevent front-to-rear cancellation can readily be figured out by dividing 1,089 by twice the frequency of the lowest sound signal to be reproduced. For example, if the lowest frequency to be reproduced is 50 cycles, the minimum path length L would be equal to 1,089 divided by 2 times 50, which is 10.89 feet.

The longer the path L around the baffle, the lower will be the cut-off frequency of the loudspeaker. Where space is limited, as it is in the conventional radio receiver cabinet, the loudspeaker is usually mounted in a box like that shown in Fig. 8C. Here path L would be measured as indicated.

Although each baffle has a definite cut-off frequency, with sounds below

this frequency being eliminated or greatly reduced in strength, this is no assurance that frequencies above the cut-off value will be reproduced without attenuation. Suppose that the diameter of the circular baffle shown in Fig. 9A is such that cut-off occurs at 100 cycles. When a 200-cycle sound is fed to the loudspeaker mounted on this baffle, the cone will go through one complete cycle during the time required for the sound to travel from the front to the rear, and consequently the compressed air traveling around the baffle will encounter rarefied air at the rear. Cancellation takes place and loudspeaker output is low at 200 cycles. This same effect will occur at each higher multiple of the cut-off frequency (3 times, 4 times, 5 times, etc.), but in the case of these higher multiples the cone will have gone through so many cycles during the time required for the compressed air to get around the baffle that most of the sound produced at the front of the cone will have traveled too far out to be affected. It is at the frequency equal to twice the cut-off frequency that cancellation is the most serious.

Irregular-Shaped Baffles. With a square baffle like that shown in Fig. 9B, the paths around the baffle are of many different lengths, so that even though cancellation occurs on some paths there will always be other paths at which a particular frequency is not entirely cancelled out. The result is that the frequency response of the loudspeaker system is far more uniform in the low frequency region down to the minimum cut-off frequency (determined by the longest baffle path length). The most uniform response at low frequencies is obtained with an extremely large baffle or with a special form of completely enclosed box baffle, sometimes

known as an *infinite baffle*. An irregular shape of baffle like that shown in Fig. 9C is better than a square or circular baffle, for this provides a number of widely different path lengths.

Box Baffles

The cabinet in which the cone loudspeaker of the average home radio receiver is mounted is essentially a box. Although this box does give the desired long path for sound around the baffle, the presence of the box or cavity behind the loudspeaker is not always desirable. This cavity can in itself be a sound resonator, acting much in the manner of a horn and setting air into vibration at some frequency. In the average radio receiver cabinet this cavity can be shocked into vibration at a low or bass frequency in many cases, producing an undesirable high bass output. The cavity is in addition a load on the cone, increasing its mechanical resistance and altering the frequency response of the loudspeaker; on the other hand, if this load produced by the cavity is properly proportioned, it can be a real aid to loudspeaker operation. Since many loudspeaker installations take into account the design of the back resonating chamber or box baffle, we will analyze this problem in greater detail in order that we can better understand the unique constructions which are sometimes employed.

With a cone mounted on a large flat baffle, the back of the cone must move equally as large a mass of air as the front of the cone. This mass has an inertia which opposes any force which tries to set it into motion, and consequently we can consider this mass as a mechanical inductance.

With a flat baffle, the mass of air in back of the cone has little stiffness,

for it can expand equally well in all directions behind the baffle. As we bend back the edges of the baffle to form a box-like chamber around the rear of the cone, we confine the mass of air to a limited region and reduce the mass upon which the back of the cone is compelled to act. Confining this air to a definite volume increases its stiffness, with the result that

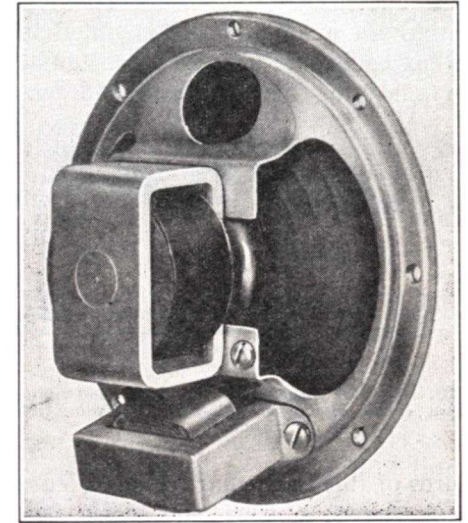

Typical electrodynamic loudspeaker, available from Jensen Radio Mfg. Co., Chicago, Ill., in 5, 6 and 8-inch sizes (cone diameters) with various output transformers and various field coil resistance values for replacement purposes.

greater force must be applied to the cone in order to move this air. This reduces the compliance of the rear chamber, thereby reducing its mechanical capacitance. (In the case of a flat baffle, this mechanical capacitance was so high that its effect could be neglected.) The mechanical force must therefore act simultaneously upon a mechanical capacitance and a mechanical inductance in parallel.

We know also that a certain amount of sound always escapes from the rear of the chamber; this radiated sound must be represented by me-

chanical resistance acting in series with the air mass. A completely closed box has no sound radiation at the rear and therefore has zero mechanical resistance. A flat baffle has a large mechanical resistance, its value being equal to the mechanical resistance existing at the front of the cone. An open box has a medium value of mechanical resistance.

With these facts in mind, we can set up the equivalent mechanical circuit of a loudspeaker mounted in a box baffle, and use this as our guide in analyzing the good and bad fea-

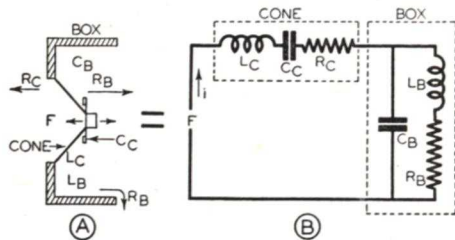

FIG. 10. Rear chamber of a box baffle, and equivalent circuit of the entire system, including the chamber.

tures of this particular baffle. Figure 10A shows a cone and voice coil mounted in a box baffle, and Fig. 10B represents the equivalent circuit including the back chamber. The mechanical force acting upon the entire system varies in an alternating manner corresponding to the variation in voice coil current. This force acts first upon the mass of the cone and voice coil assembly, represented in Fig. 10B as mechanical inductance L_C , upon the spider which provides springiness or mechanical capacitance C_C , and upon the mechanical resistance due to sound radiation from the front of the cone, represented as R_C . The additional load placed upon the cone by the back chamber can be represented by mechanical capacitance C_B in parallel with mechanical inductance L_B , representing the mass

of the back chamber air; the mechanical resistance introduced by sound radiated from the rear of the baffle is represented as R_B , acting in series with L_B .

We can now see that C_B and L_B in Fig. 10B together form a parallel resonant circuit. Furthermore, this resonant circuit can be shocked into self-oscillation by the driving force F acting through the reactances of L_C and C_C , under which condition the air in the cavity will vibrate and radiate sound through the cone. This self-produced sound may set the cone into vibration, producing frequencies which were not present in the original program and giving the so-called boomy response which some loudspeakers have. Furthermore, if the driving force F has the same frequency as the resonant frequency of the cone loudspeaker unit (resonant circuit L_C-C_C), the cone will be set into excessive vibration, giving a whooping sound. This occurs because L_C-C_C acts as a low mechanical resistance at resonance, allowing more of the driving force F to be applied to the cavity and increasing the sound output of the back chamber at that particular frequency.

Natural Resonant Frequency. Increasing the size of a box baffle increases the volume of the cavity and thereby increases the values of mechanical capacitance C_B and mechanical inductance L_B ; this lowers the natural resonant frequency of the cavity (the resonant frequency of the parallel resonant circuit). If the box is made sufficiently large or if an infinite flat baffle (where no sound waves whatsoever can escape to the rear of the cone around the baffle) is used, the natural frequency of the region behind the cone can be made so low that the effects of cavity resonance will not be heard at all.

A radio receiver which has an open back is generally designed so that when the cabinet is kept a few inches away from the wall or is placed in a corner so there is free movement of air behind the cabinet, C_B will be high enough in value to prevent audible cavity resonance effects. Placing the radio receiver back up against the wall tends to close up the back chamber and reduce C_B ; under this condition cavity resonance may occur at an audible bass frequency, in the form of boominess and the whooping sounds mentioned before. Remember: radio receivers with open backs will sound best when kept a few inches away from the wall or when located across a corner of a room.

Infinite Baffles. Suppose that we closed up the back of the cabinet com-

will be no vibration of the cone at resonance, no whooping sounds, no sound waves will be radiated by the back of the cabinet, and we will have what is known as an *infinite baffle*. Figure 11 shows more clearly what happens under this condition; curve 1 shows how cone velocity, which determines sound output to a great

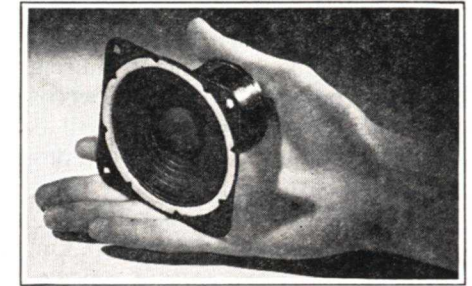

Courtesy Oxford-Tartak Radio Corp.

Truly a midget is this Oxford permanent-magnet dynamic loudspeaker unit with 3" diameter cone, designed for use in midget table model radios and in intercommunication systems.

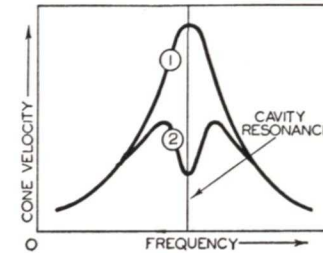

FIG. 11. These curves show how cone velocity (which determines sound output) varies with frequency for an ordinary box baffle (curve 1) and for a box baffle which is tuned to the natural resonant frequency of the moving system (curve 2).

pletely, thereby making the values of C_B and L_B constant. This, of course, does not in itself eliminate cavity resonance, but if we make the resonant frequency of C_B-L_B equal to the resonant frequency of L_C-C_C , an entirely new effect will take place. When the driving force F has this same frequency, the series resonant circuit will act as a very small resistance, but the parallel resonant circuit will act as a very high resistance, greatly limiting the flow of mechanical current i . This means that there

extent, increases gradually with frequency up to a maximum value at a frequency equal to the natural resonant frequency of the cavity. At frequencies above cavity resonance, the cone velocity drops again. Curve 2 is for the condition where the cavity is tuned to the natural resonant frequency of the cone; you can see that the peak has been reduced considerably at resonance, while cone velocity is still high enough to give the system desired bass reinforcement. *Adjusting the cavity resonant frequency to the natural frequency of the cone system* will greatly reduce the undesirable effects of cavity resonance in a box type baffle.

Standing Waves. At frequencies higher than the cavity-resonance frequency, the cavity will act as a low-reactance condenser which does not seriously affect the response of the loudspeaker. At the higher sound

frequencies, however, where the wavelengths involved become shorter than the dimensions of the box, there will be considerable reflection of sound from one side of the box to the other. If these reflections occur continually over the same path, the compressions and rarefactions of air will be reinforced at definite points, and *standing sound waves* will occur; these give resonant effects much like those produced in organ pipes and in musical wind instruments. In other words, sounds at certain frequencies will be prolonged somewhat, due to the production of harmonics, and the reproduced sound will not be natural.

Using a shallow cavity or making it irregular in shape so that reflected sounds cannot build up along the same path will cure this trouble. Other remedies involve lining the box with a sound-absorbing material, hanging heavy sound-absorbing materials down from the top inside the box, or lining the sides of the box with rectangular pieces of wood, thereby preventing sounds from being reflected back and forth over the same path. Whenever sound waves are reflected repeatedly over a path which is some multiple of a half wave in length, compression will occur at the same points along this path for each reflection. Reinforcement of sound occurs under this condition due to the building up of pressure, and the resulting standing waves produce annoying sounds. The box itself should be made of heavy wood, so it will not vibrate at the lower bass frequencies.

So far we have considered box baffle arrangements which are intended to prevent cavity resonance at low frequencies and standing waves at high frequencies. In each case the sounds produced by the rear of the cone were either suppressed or absorbed, and were therefore wasted.

Bass-Reinforcing Box Baffles. Increased bass output is practically always desirable in a loudspeaker if it can be secured without at the same time producing undesirable cavity resonance effects. We know that the sounds coming from the rear of the cone are out of phase with those coming from the front; if, however, we can reverse the phase of the bass notes coming from the rear and allow them to emerge at the front of the loud-

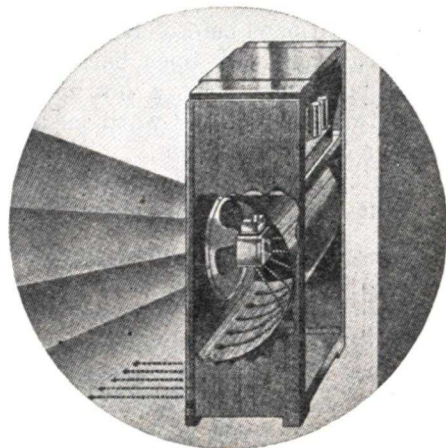

RCA Sonic-Arc Baffle, also known as the Magic Voice, which provides bass reinforcement and at the same time prevents standing waves.

speaker, we can secure desirable reinforcement of bass notes without increasing cavity resonance problems. The loudspeaker arrangement which accomplishes this result is known as a *low-pass, phase-reversing acoustical filter*.

The back of the cabinet or box is ordinarily closed completely when bass reinforcement is desired, and outlets for air are provided either underneath the cabinet or at the front, below the main outlet at the front of the cone. Our equivalent mechanical circuit for this condition is therefore the same as that shown in Fig. 10B. Again we can assume that undesirable effects of cavity res-

onance are greatly reduced by making the resonant frequencies of the cavity and the cone identical.

Above the resonant frequency of the cone or the cavity, the series resonant circuit L_C-C_C acts as a mechanical inductance, while the parallel-resonant circuit L_B-C_B acts as a mechanical capacitance. To simplify further our analysis, let us assume an above-resonance condition (in which the frequency of mechanical force F is higher than the natural resonant frequencies of the cone and box). In

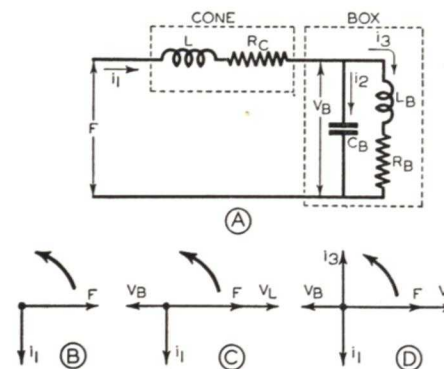

FIG. 12. Equivalent acoustical circuit of a closed box baffle which is acting as a low-pass, phase-reversing acoustical filter at frequencies above the resonant frequency of the cone, and vector diagrams showing how it acts.

this case, series resonant circuit L_C-C_C , representing the cone assembly, will act as a mechanical inductance (which we can designate as L) in series with mechanical resistance R_C ; the equivalent mechanical circuit will now appear as shown in Fig. 12A.

If we can prove that mechanical current i_3 flowing through mechanical resistance R_B is 180° out of phase with mechanical current i_1 flowing through R_C , we will have shown that radiation of sound from the cavity will be 180° out of phase with the sound radiated by the back of the cone, and will therefore be *in phase* with sound radiated from the front of the cone.

Above resonance, parallel resonant circuit L_B-C_B will act as a mechanical capacitance, and if by design its mechanical reactance is *less than* the mechanical reactance of L , the mechanical force F will feel an inductive load. The mechanical current i_1 delivered by F will therefore lag F by 90° .

A vector diagram will show at a glance the exact phase relationships between the various mechanical currents and voltages in our circuit. Let us use F as our reference vector, drawing it as shown in Fig. 12B. Since we have just found that i_1 lags F by 90° , we draw i_1 downward, 90° clockwise from F .

The mechanical force acting upon C_B and L_B will be equal to the applied force F minus the mechanical force dropped across inductance L . (We are now neglecting R_C and R_B , as they have little effect.) This mechanical force (mechanical voltage) V_L which is dropped across L will *lead* the current i_1 through L by 90° (coil voltage always leads coil current by 90°), so we draw vector V_L 90° counter-clockwise from vector i_1 , as in Fig. 12C. Now we can see that V_L is in phase with F .

We also know that the voltage across a condenser lags its current by 90° . Since parallel resonant circuit L_B-C_B acts as a condenser at frequencies above resonance, mechanical voltage V_B across this circuit will lag i_1 by 90° ; we therefore draw in vector V_B 90° clockwise from i_1 , as in Fig. 12C. Since V_B acts upon L_B , we can say immediately that mechanical current i_3 through L_B will lag V_B by 90° , and can draw in vector i_3 90° clockwise from V_B , as in Fig. 12D. Our vector diagram now shows clearly that i_3 is 180° out of phase with i_1 , which is exactly what we desired to prove.

By proper selection of the mass (L_B) and compliance (C_B) of the box cavity in relation to the mass (L_C) and compliance (C_C) of the loudspeaker cone, an engineer can secure a loudspeaker system which will behave like the circuit in Fig. 12A. Sound waves escaping from the box will then be in phase with the sound radiated from the cone front, and the desired bass reinforcement will be secured at frequencies above the cavity resonant frequency.

At high sound frequencies, mechanical capacitance C_B serves as a shunt path for mechanical current, with the result that practically no mechanical current flows through R_B , and no high-frequency sounds emerge from the box cavity.

Stromberg-Carlson Acoustical Labyrinth. An excellent example of the baffle design features just discussed is the acoustical labyrinth or winding passageway which is built into the cabinets of some Stromberg-Carlson receivers for four distinct purposes: 1, to prevent cavity resonance; 2, to prevent standing high-frequency sound waves; 3, to give a low cut-off frequency for the baffle without resorting to an excessively large cabinet; 4, to give reinforcement of bass response by allowing low frequency sounds radiated from the rear of the cone to travel through the labyrinth and emerge at the front in phase with the sounds normally radiated from the front of the cone. The two views in Fig. 13 illustrate the nature of this special loudspeaker baffle construction.

Observe that a felt hood covers the entire rear face of the cone, with only the pot exposed to air for cooling purposes. Sounds radiated by the rear of the cone are therefore directed into the rectangular cross-section passageway which winds back and forth down

to the bottom of the cabinet. The insides of this passageway or labyrinth are lined with a porous sound-absorbing material which is held together by coarse metal screening. High-frequency sounds are totally absorbed by this material, while lower frequency sounds are only partially absorbed. The long passageway with its outlet at the far end has the essential features of mass, compliance and resistance which are necessary for a low-pass phase-reversing acoustical filter at bass frequencies, and the result is that bass sounds emitted at

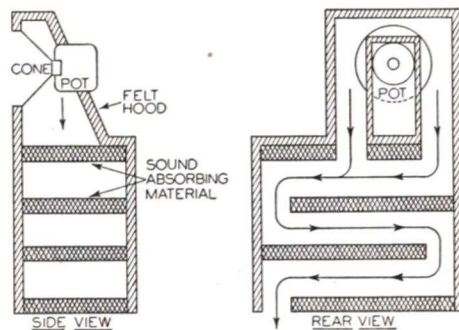

FIG. 13. Essential constructional features of the Stromberg-Carlson Acoustical Labyrinth.

the lower end of the labyrinth reinforce the bass sounds radiated from the front of the cone.

Special RCA Box Baffles. To secure the same effects as are provided by the acoustical labyrinth, RCA engineers use the construction shown in Fig. 14A for some of their receivers. The back chamber is completely closed, but there are holes at the bottom of the chamber, each surrounded by a length of pipe, through which air can escape. The back chamber thus has mass and compliance, and that air which escapes through the pipe provides mechanical resistance. The pipes are intended to adjust the mass in order to make the chamber resonate at the same fre-

quency as the cone. The entire cabinet of this RCA receiver is made of heavy wood, to prevent it from vibrating and radiating sounds from all sides when powerful bass notes are being reproduced. Only sounds emerging from the pipes are capable of reinforcing the normal output.

Pipes are by no means essential in the design of an acoustical low-pass filter; simple outlets are sufficient if the cabinet is properly designed to secure the correct resonant frequency for the cavity. Many RCA receivers have this simplified construction, illustrated in Fig. 14B. The back of the cabinet is closed by a curved sound reflector which serves two purposes, that of reflecting high-frequency sounds in all directions to prevent standing sound waves, and that of stiffening the back so it will not vibrate as readily as would a flat board. The air enclosed by this chamber provides compliance and mass, and the air escaping through the outlet at the bottom provides mechanical resistance; we thus have the conditions necessary for bass reinforcement.

Another example of this simplified construction is illustrated in Fig. 15. This is a special high-fidelity, high-power loudspeaker unit made by Jensen and known as the Peridynamic or bass reflex loudspeaker. The cabinet is made of thick, solid material so its sides will not vibrate. The box is made shallow so standing waves will be negligible. The cavity is properly proportioned to give the essential requirements of an acoustical filter.

Some manufacturers of radio receivers and cabinets follow the practice of closing up the back of the cabinet with a solid board which is reinforced with crossed ribs to prevent it from vibrating, allowing sounds to escape only from the corners of the

back through holes which are left at these points. Again, proper design gives desirable bass reinforcement and eliminates undesirable features of a

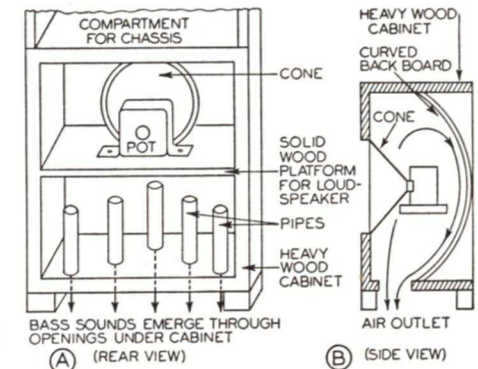

FIG. 14. Constructional features of two types of low-pass, phase-reversing acoustical filters used in RCA receivers.

cavity. Do not think that because a loudspeaker cabinet appears simple in construction, it is easy to design and build; careful engineering is required in order to prevent cavity resonance, to prevent standing sound waves at high frequencies, and to secure the proper proportioning of acoustical elements in the cone and cavity in order to obtain the desired bass reinforcing action.

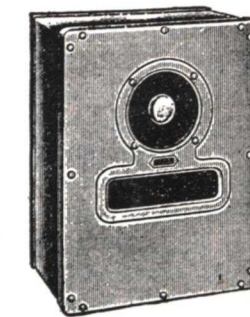

FIG. 15. Jensen Peridynamic loudspeaker unit. Reinforcing bass notes emerge from the rectangular opening below the cone.

Acoustic Clarifiers. When no attempt is made to utilize bass sounds emerging from the rear of a loudspeaker system, the chief problem is

that of removing cavity resonance effects or making them inaudible. It is possible to do this by inserting in the cavity an acoustic clarifier, a device which itself vibrates readily at all times and serves to cancel the air vibrations in the cavity. Some Philco receivers utilize this principle, in the form of a small cone which is suspended on an elastic spider mounted in the cabinet cavity or chamber. Any sudden loud sounds or sustained sounds which would otherwise set the cavity into vibration are transferred to this suspended cone, causing it to vibrate and absorb the energy present in the chamber. As a result there is very little vibration of the air in the chamber, and no sounds are emitted from the rear. Several of these acoustic clarifiers are generally used in a single cabinet, so as to increase the coupling between the cavity and the clarifiers. The clarifiers are sufficiently broad in frequency response to prevent cavity resonance effects when the back of the cabinet is open and the cabinet is placed flat against a wall. Remember, however, that acoustic clarifiers are not loudspeakers.

The principle of an acoustic clarifier can best be explained by referring to the electrical circuit shown in Fig. 16. Here we have a parallel resonant circuit made up of L_1 and C_1 , driven by an A. C. voltage source V ; this, as you know, is equivalent to the parallel resonant circuit representing the back chamber of a loudspeaker cabinet. At resonance, large currents flow through L_1 and C_1 , making this circuit act like a high resistance. If we place across this parallel resonant circuit a series resonant circuit made up of C_2 and L_2 , and make both resonant circuits tune to the same frequency, the series resonant circuit will at resonance act as a short across the

parallel resonant circuit. As a result, the source V will be supplying current to the series resonant circuit, while the parallel resonant circuit will receive practically no current. This series resonant circuit is the equivalent of the acoustic clarifier; it cancels the sound waves which otherwise would result in oscillation or vibration of the air in this back chamber.

Sound Diffusers

When sound is produced by a small source, all audio frequencies travel equally well in all directions away

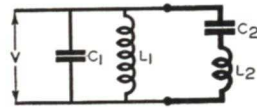

FIG. 16. An electrical circuit explaining the operation of the Philco Acoustic Clarifier.

from the source. When the size of the sound-producing source is quite large, however, as is the case with loudspeakers using large diaphragms and cones, only the low audio frequencies will travel equally well in all directions. The higher frequencies tend to travel best straight ahead of the loudspeaker, concentrating into a beam which becomes smaller and smaller in size as frequency is increased.

Loudspeaker engineers utilize what is known as a polar radiation pattern to show how a particular loudspeaker radiates various audio frequencies in different directions; one such pattern, representing the manner in which a cone loudspeaker with a baffle radiates one particular sound frequency in various directions, is shown in Fig. 17A. Let us first see how a pattern such as this is secured, for then we will be better able to appreciate the interesting information which it can give about a loudspeaker.

With our loudspeaker and baffle set up in a large room having sound-absorbing walls, floor and ceiling, and a definite audio frequency fed through the voice coil of the loudspeaker, we measure the loudness of the sounds produced by the loudspeaker at various points such as at P_1 , P_2 , P_3 and P_4 , which are all the same distance away from the center of the loudspeaker and make various angles, such as θ (Greek letter *theta*), with the center line $O-P_3$. We will designate as I_3 the loudness level measured at point P_3 . We now draw on paper a simple sketch of our loudspeaker, much like that in Fig. 17A, and mark point O as the approximate center of the sound-producing source. Point P_3 is placed on the diagram next, directly in front of the loudspeaker, and at any convenient distance away. A line is drawn from O to P_3 , and along this line we plot the measured value I_3 to any convenient scale, starting from O . We next move our measuring apparatus to position P_2 , which is off to one side of line $O-P_3$ by the angle θ but is still the same distance away from O . We measure the angle θ made by lines drawn from O to P_2 and P_3 , and use this angle as our guide in locating P_2 on the diagram. The loudness level measured at P_2 is now plotted along line $O-P_2$, starting from O ; this gives point I_2 in Fig. 17A. The same procedure is repeated for points P_1 , P_4 and various other points which are all the same distance away from O and at various angles off to each side. A smooth curved line drawn through the resulting points I_1 , I_2 , I_3 and I_4 now gives the polar radiation pattern. In the case of Fig. 17A, this pattern tells us that at a definite distance away from the loudspeaker, sounds will be loudest directly in front of the cone and will gradually become

weaker as we go off to one side or the other of the center line.

Radiation patterns for three different frequencies, as secured with a large dynamic loudspeaker mounted in a box baffle, are shown in Fig. 17B. All three curves are for measurements made at the same distance away from the loudspeaker. These curves tell that a listener at position P_1 would hear middle frequencies best, with bass frequencies slightly less loud and treble frequencies about half as loud. On the other hand, a listener at position P_2 would hear bass frequencies the best, with middle frequencies slightly weaker and treble sounds

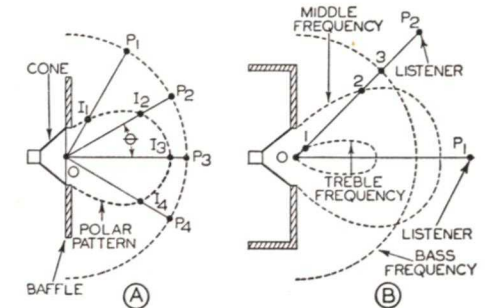

FIG. 17. Polar sound radiation patterns for cone loudspeakers.

scarcely distinguishable at all. A line drawn from any other listening position to point O will give this same information for that position; simply observe where the line intersects each of the three curves. Now you can readily understand why the output from a loudspeaker sounds best when you are located directly in front of it.

Uniform distribution of sound from a loudspeaker throughout a room is highly desirable, for the non-uniform distribution shown in Fig. 17B tends to cancel out, for certain listening positions, all the advantages gained by careful design of the radio receiver and loudspeaker. Since high frequencies give the greatest trouble in this respect, the loudspeaker engi-

neer often builds vanes in front of the loudspeaker to deflect these frequencies and spread out the beams. If the vanes are of the proper size, at least as wide as the wavelength of the high-frequency sounds to be deflected, the vanes will have no effect upon low and medium frequencies.

A wall-type loudspeaker, with deflecting vanes mounted in front of the cone for this purpose, is shown in Fig. 18A. Sometimes these vanes are mounted behind the grille cloth or are made a part of the cabinet itself.

A well designed deflector for high-frequency sounds is shown in Fig. 18B; this is a curved cone anchored rigidly inside the regular sound-producing cone of the loudspeaker. High-frequency sounds are deflected by this cone and spread out on all sides, while low- and medium-frequency sounds travel around the cone just as if it were not present.

Horn loudspeakers concentrate all sounds into relatively narrow beams, with the highest frequencies being concentrated the most. When a horn loudspeaker is used as a tweeter for the reproduction of high frequencies only, it is often sectionalized in the manner shown in Fig. 19 in order to spread out the beam and make the distribution of high-frequency sounds similar to that of the low- and medium-frequency sounds as produced by the woofer (low- and medium-frequency) loudspeaker. The presence of vanes in one or more units of a reproducing system is usually a sign of high-fidelity reproduction over a wide range of frequencies; this particularly holds true for the loudspeakers used in public address systems.

Horn-Shaped Baffles

Large cone loudspeakers are widely used in public address systems requir-

ing high sound outputs. Cone loudspeakers mounted in a large flat baffle or in a box baffle radiate sound over a wide angle; this may not be

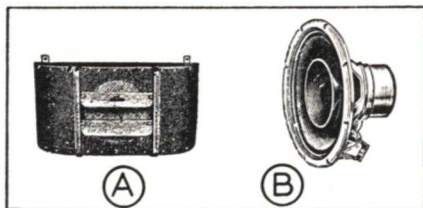

FIG. 18. Examples of cone loudspeakers which utilize deflecting vanes to spread out high-frequency sound waves.

desirable in some installations, for it is often necessary to concentrate sound in a definite direction and over a definite area. Horn-shaped baffles are used for this purpose; when properly designed, these make the loudspeaker more directional and at the same time improve its efficiency considerably.

Loudspeaker Efficiencies. The ordinary large cone loudspeaker, when mounted in a box baffle or on a flat baffle, rarely has an efficiency of greater than 3 per cent, whereas a driving unit used with an exponential horn can have an efficiency as high as 50 per cent. This means that if 10 watts of electrical power are fed into



FIG. 19. Horn loudspeakers designed for use as tweeters are often divided into sections as shown above in order to spread out high-frequency sounds.

a cone loudspeaker, only about .3 watt of acoustical power will be delivered. This low cone loudspeaker efficiency is satisfactory for the aver-

age home radio receiver, but in loudspeakers designed for high-power public address systems it is necessary to improve this efficiency by improving the coupling between the cone and the surrounding air. Loudspeaker engineers therefore turn naturally to the exponential horn when the efficiency of an ordinary baffle for a cone loudspeaker proves unsatisfactory.

An early attempt to improve the directional characteristics of a cone loudspeaker is shown in Fig. 20A; the performance of this flat-sided horn was no better than that of the early megaphone used with smaller driving units. Modern exponential horn

sounds back and forth inside the horn. The area of the mouth of the horn approaches the area of a circle whose diameter equals 1/4 wavelength at the lowest frequency to be reproduced.

Loudspeaker Impedance

Any loudspeaker has a definite electrical impedance. The value of this impedance will depend upon the frequency of the source voltage applied to the loudspeaker, upon the electrical characteristics of the loudspeaker (inductance and resistance for magnetic and dynamic driving units, and capacitance with resistance

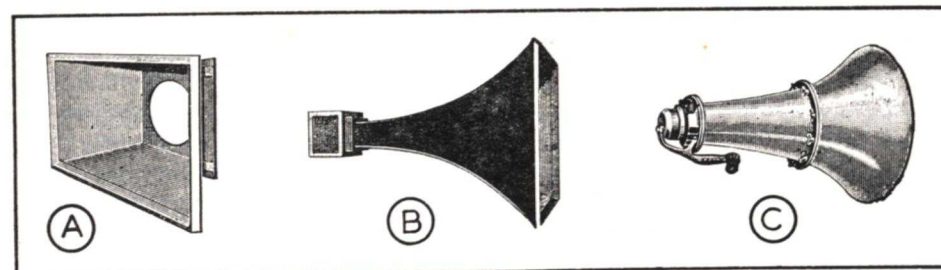

FIG. 20. Examples of horn baffles for cone loudspeakers. A—simple flat-sided, megaphone-like horn; B—complete cone loudspeaker unit with true exponential horn baffle having a square cross-section; C—another complete cone loudspeaker unit with an exponential horn of the trumpet type, spun from aluminum.

baffles or cone loudspeakers are shown in Figs. 20B and 20C. Since these start with a large throat, they need not be extremely long in order to secure good response over a wide range of frequencies. If the loudspeaker and cone are designed with a closed back, to give high air velocity at the front of the cone, and the usual precautions are taken to secure piston action over the entire audio range of frequencies, the addition of an exponential horn of this type will greatly improve the efficiency of operation.

In Fig. 21 is shown a large exponential horn which is fed by six large cone loudspeakers. Careful design is essential to prevent reflection of

for crystal and condenser driving units), and upon the load which is placed upon the loudspeaker by the surrounding air.

We have already seen that the driving unit of a loudspeaker, when

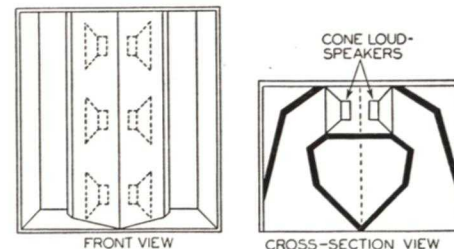

FIG. 21. Two views of an unusually large exponential horn baffle which is fed by six large cone loudspeakers. This assembly is capable of delivering high sound output power at high efficiency. It is made by Lansing Manufacturing Company, Los Angeles, Calif.

in operation, has mechanical inductance, mechanical capacitance and mechanical resistance. Let us consider a simple loudspeaker in which these three mechanical components act in series upon a dynamic cone loudspeaker having electrical inductance and resistance. The complete circuit for this loudspeaker is best represented as in Fig. 22. Here e_P represents the A.C. source voltage applied to the loudspeaker (this will be the A.C. output voltage of the audio amplifier), r_P represents the resistance of the source (the A.C. plate resistance of the output tube), R_V represents the resistance of the voice coil, L_V represents the inductance of the voice coil, M represents the electromechanical coupling, L_M the mechanical inductance (the mass of the moving element), C_M the mechanical capacitance (the compliance or springiness of the spider), and R_M the mechanical resistance. Clearly these mechanical components exist only when the driving unit is in motion; when the voice coil is wedged in position so it cannot move, the source would feel only the electrical components, R_V and L_V . By measuring the electrical characteristics of the loudspeaker under this condition, we can determine what these electrical values are.

When the voice coil and cone of the loudspeaker are free to move, and the loudspeaker is accomplishing useful work in converting electrical power into acoustical power or sound, the source feels all of the mechanical components just as if they were in an electrical circuit like that shown in Fig. 22. For example, if the source frequency is such that the mechanical reactance of L_M equals the mechanical reactance of C_M , mechanical resonance occurs and only mechanical resistance R_M is reflected through M

into the primary circuit. When the source frequency is above the resonant frequency of the secondary, the mechanical reactance of L_M exceeds that of C_M , with the result that a mechanical inductance and mechanical resistance are reflected into the primary as a mechanical capacitance and mechanical resistance.

These facts are mentioned merely to show that when the electrical impedance of a loudspeaker is measured across its terminals (between terminals 1 and 2 in Fig. 22), a different value of impedance will be secured at each frequency; furthermore, this impedance will not be made up of voice coil reactance and resistance alone, but will also include those effects of the mechanical components which are felt by the source. The circuit in Fig. 22 tells us that the power input to the loudspeaker and consequently the useful sound power output will be a maximum when the source impedance (resistance) r_P is exactly matched to the load impedance (the loudspeaker input impedance) as measured between terminals 1 and 2.

Clearly the matching of the loudspeaker impedance with that of its voltage source is quite important if greatest sound power output is to be obtained. The circuit in Fig. 22 shows that the D.C. resistance R_V of the loudspeaker, which can be measured with an ohmmeter, cannot be considered alone when securing a proper match; it is the loudspeaker impedance as measured while the loudspeaker is actually in operation which must be matched to the source impedance.

Determining Loudspeaker Impedance. Unfortunately the impedance of a loudspeaker is not constant for all frequencies, nor is the mechanical load of a loudspeaker as simple as is represented electrically in Fig. 22.

For these reasons it is necessary to measure the loudspeaker impedance at the frequency which we wish to reproduce at greatest volume, and secure a correct impedance match for this frequency.

For the average loudspeaker an impedance match at about 1,000 cycles is usually quite satisfactory. With tweeter loudspeakers, however, a match at 4,000 cycles would be better. Loudspeaker manufacturers recognize these problems, and specify a value of loudspeaker impedance which, if matched, will give the best over-all results over the frequency range to be handled. For example, when the impedance of a loudspeaker voice coil is specified as 8 ohms, this will take into account mechanical as well as electrical factors and will probably be an impedance measurement made while the loudspeaker was reproducing a 1,000 cycle audio signal.

When the impedance of a dynamic loudspeaker is unknown, some servicemen measure the voice coil resistance with an ohmmeter and assume an impedance value equal to 1.5 times this measured D.C. resistance. We know that this value can be considerably in error, but it at least serves as a guide when a more accurate impedance value is not available.

Matching. Knowing the impedance of the loudspeaker at the average or predominant frequency in the range of audio sounds being handled, the next step is to match this impedance to the impedance of the electrical signal source, in order to secure maximum useful sound output. When vacuum tube amplifiers, which are the usual signal sources for loudspeakers, feel anything different from the correct, properly matched load, the wave form of the signal fed to the loudspeaker will be distorted. The reason for this is simply that with an improper im-

pedance match the output tube of the amplifier no longer operates over the linear portion of its dynamic E_g-I_p characteristic. Regardless of whether the output stage uses class A, push-pull or push-push operation, best results are obtained when the load placed on the stage has the correct impedance value.

With the loudspeaker impedance and the required load impedance of the amplifier known, there remains only the connecting together of source and load by means of a suitable matching or output transformer. Since the re-

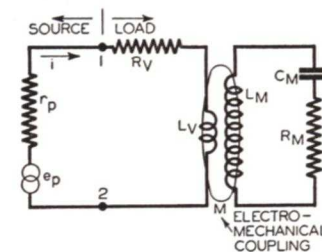
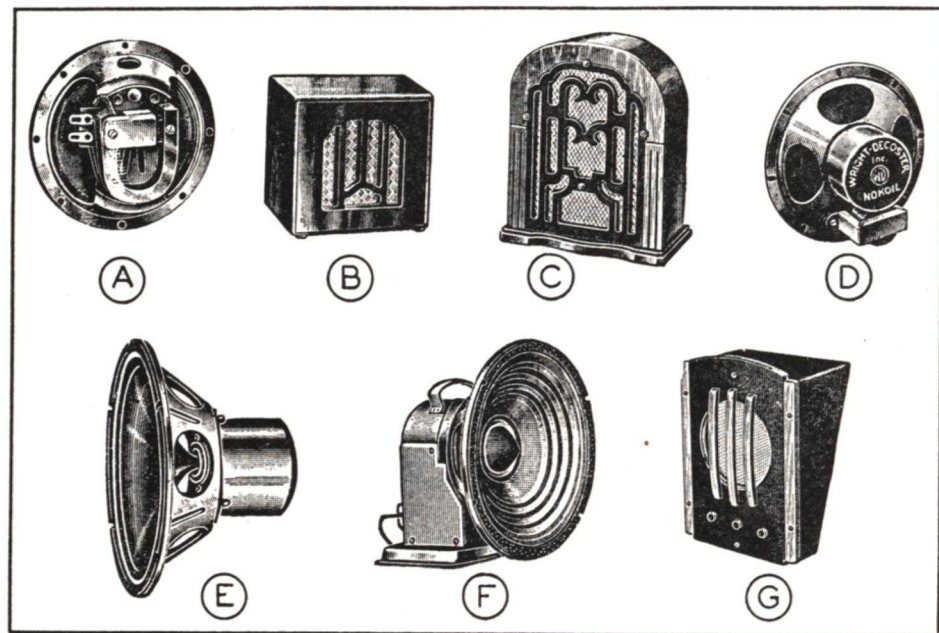

FIG. 22. Equivalent circuit of a complete loudspeaker unit connected to a source of audio frequency power.

quired plate load impedance is usually much greater than the loudspeaker impedance, a step-down transformer is needed; its turns ratio is determined simply by dividing the required plate load impedance by the loudspeaker impedance and then taking the square root of the resulting number. (Taking the square root of a number means finding a smaller number which, when multiplied by itself, will give the original number.) The primary winding, which connects into the plate circuit of the output tube or to the plates of the tubes in a push-pull or push-push output stage, will have the greatest number of turns and will therefore usually have the greatest D.C. resistance. The secondary winding has the least turns and connects to the loudspeaker voice coil leads. Here is an example: If a push-pull output stage

requires a 2,000-ohm load for greatest undistorted output power, and the loudspeaker has a specified impedance of 20 ohms, our impedance ratio is 2,000 divided by 20, which is 100. Taking the square root of 100, we get 10 as the turns ratio of the output transformer. The primary winding

Typical Loudspeaker Matching Circuits. A typical connection of a loudspeaker and output transformer to a single tube output stage is shown in Fig. 23A. The recommended plate load impedance of the pentode output tube and the average voice coil impedance of the loudspeaker determine



These diagrams illustrate a number of the interesting features of cone loudspeakers which are taken up in this lesson.

A—Balanced armature driving unit which is coupled mechanically to a medium-sized free-edge cone. This unit is commonly known as a magnetic loudspeaker.

B and **C**—Typical small cabinets used for magnetic loudspeakers.

D—Permanent-magnet dynamic cone loudspeaker; this is similar in appearance to many electrodynamic loudspeakers, but the trade name NOKOIL indicates a permanent magnet construction.

E—Special form of dynamic loudspeaker employing a para-curve or curvalinear cone in order to provide uniform response over a wide range of frequencies.

F—Dynamic loudspeaker employing a corrugated cone construction for uniform response over medium frequencies; the conical plug over the moving coil in the center of this cone serves to diffuse high frequency sounds in all directions and to increase the frequency range over which piston action is secured.

G—Special dynamic loudspeaker cabinet designed for wall mounting. Magnetic loudspeakers are also available in cabinets like this.

will therefore have 10 times as many turns as the secondary winding. With the loudspeaker connected to the secondary winding and an audio signal of average frequency being fed into the primary winding, the measured impedance of the primary will be 2,000 ohms, and we therefore have a correct impedance match.

the turns ratio required for the output transformer.

A typical loudspeaker connection for a two-tube output stage is shown in Fig. 23B. With class AB or A' push-pull operation, a C bias resistor must be inserted in the circuit at point X to provide a negative C bias for each tube, and this resistor must be

shunted with a high-capacity condenser. Since only one tube works at any instant of time, and feeds into only one-half of the output transformer primary winding, we must multiply the recommended plate load impedance for one tube by 2 in order to determine the turns ratio for the entire output transformer.

With high-impedance loudspeakers, such as those employing magnetic, condenser or crystal driving units, the loudspeaker impedance may be very close to that required by the output tube. The loudspeaker may in this case be connected as in Fig. 23A, using

placement transformer in every case in order to insure a correct match and duplicate the original performance of the receiver. This is particularly important in the case of receivers or public address amplifiers designed for high-fidelity operation.

When exact replacement transformers are not available, you can make a satisfactory replacement with little apparent change in performance by selecting a transformer having the correct turns ratio and a sufficiently large power-handling rating. Few radio men are able to order transformers on this basis, however; for

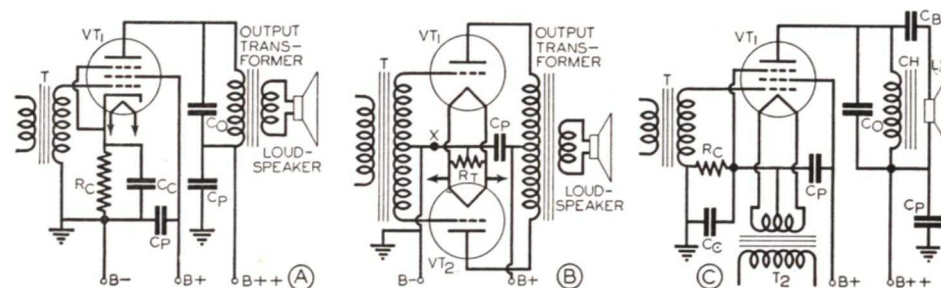

FIG. 23. Typical loudspeaker connections to output stages. Condenser C_O is often included to prevent self-oscillation of the output stage, to alter the frequency response of the amplifier, or for both reasons.

a 1-to-1 turns ratio output transformer (having the same number of turns on the primary as on the secondary), or a direct loudspeaker connection to the plate circuit may be made in the manner shown in Fig. 23C. In this latter case the D.C. plate current of the output tube flows through iron-core choke coil CH to the power supply, while signal currents flow through D.C. blocking condenser C_B and the loudspeaker. The inductance of choke CH must be sufficiently high to prevent excessive bypassing of audio frequency current around the loudspeaker.

Replacement of Output Transformers. When output transformers become defective and must be replaced, it is best to use an exact re-

this reason radio supply houses list replacement transformers for use with particular output tubes and for either single- or two-tube output stages. These transformers are designed on the assumption that most dynamic loudspeakers have a normal voice coil impedance of about 10 ohms.

Radiotronics oftentimes prefer to use universal output transformers, a few of which they can keep on hand at all times. These transformers are available in various power ratings, and have a number of taps on the secondary to provide various turns ratios. The primary winding has a center tap which is used with two-tube output stages but is ignored in the case of a single-tube output stage. The taps on the secondary usually

provide for voice coil impedances of from 1 to 30 ohms. Use that tap which gives the greatest volume along with clearest tone when an actual radio program is being reproduced. For a more accurate determination of the correct tap, connect a cathode ray oscilloscope to the voice coil terminals, feed into the audio amplifier a pure sine wave signal first at 100 cycles, then at 1,000 cycles and 4,000 cycles, and select that tap which gives the greatest output voltage along with sine wave output for all three of these frequencies.

Field Coil Connections for Electrodynamic Loudspeakers

Most of the dynamic or moving coil loudspeakers used in radio receivers are of the electrodynamic type, employing a field coil for the production of a fixed magnetic flux. The average power used is from 7 to 15 watts. In many cases these coils are made to serve also as chokes for the power pack system, for at power line frequency the field coil has an appreciable inductive reactance. When used in this manner in place of a filter choke, the D.C. resistance of the field coil becomes important, for this resistance reduces the net D.C. supply voltage which is available for the tubes in the receiver.

The loudspeaker field coil connection shown in Fig. 24A is without doubt the most widely used connection today in radio receivers. The D.C. resistance of a field coil used in this manner will usually be somewhere between 500 and 2,000 ohms. Since the D.C. current drawn from the power pack by the various receiver circuits must pass through this field coil, the coil must be capable of handling this current without excessive overheating. When the receiver has a push-pull output stage, com-

plete filtering of the plate and screen grid voltages for the stage is not necessary, and a somewhat higher D.C. voltage is obtained by connecting to point X rather than to B+.

Since the power pack output voltage is considerably lower than that in an A.C. receiver, any loudspeaker field coil connection which would reduce this output voltage even more is obviously not desirable. For this reason the field coil of a loudspeaker in a universal receiver is usually independently supplied with rectified current in a manner similar to that shown in Fig. 24B. In this circuit, one half of the 25Z5 double diode rectifier tube supplies current for the field coil, with filter condenser C_1 removing the pulsations in the half-wave rectified output current. The other diode section of this tube likewise delivers half-wave rectified current which is smoothed by filter condenser C_2 and choke coil CH. This choke coil is sometimes replaced by a resistor or is omitted entirely, and a higher-capacity filter condenser is used to provide the necessary filtering. The D.C. resistance of the loudspeaker field coil is usually larger than 2,000 ohms in a circuit of this type, in order to limit field coil current and prevent overloading of the rectifier.

In addition to providing a fixed magnetic flux and filtering the power pack output current, a loudspeaker field coil is sometimes made to serve a third purpose, that of providing a negative C bias voltage for the receiver stages. A tap is provided on the field coil for this purpose, as indicated in Fig. 24C; the value of the bias voltage produced depends upon the resistance which is present between the B- terminal of the power pack and the tap, and upon the amount of D.C. current flowing

through this resistance. The entire D.C. voltage drop across the loudspeaker field coil can also be utilized for C bias purposes; the C-- terminal in Fig. 24C thus provides a greater negative bias voltage than the C- terminal.

Separate Field Supplies. Loudspeakers used with public address amplifier systems must often be located a considerable distance away from the

Fig. 24E. The vacuum tube rectifier normally supplies an output voltage of over 250 volts, and the field coil used with this supply must therefore have a high resistance in order to limit the current to a safe value. With the dry disc type of rectifier, the output voltage will usually be less than 100 volts, and a lower-resistance field coil can be used. The present trend is toward use of permanent magnet

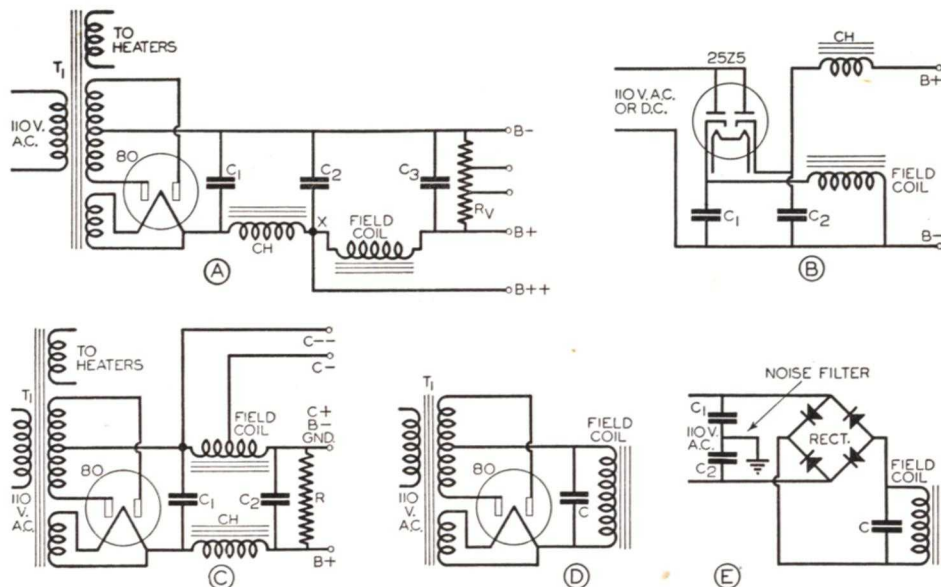

FIG. 24. Typical electrodynamic loudspeaker field supply connections.

amplifiers. If field coil leads were run from the loudspeaker location to the amplifier, the resistance in these leads would be excessive. The same holds true for extra loudspeakers, which are often connected to radio receivers but located some distance away from the receiver. In cases like these, it is necessary to use a separate field supply located at the loudspeaker if it is of the electrodynamic type. This field supply may consist of a full-wave vacuum tube rectifier like that shown in Fig. 24D, or may be a full-wave bridge type rectifier using copper-oxide discs, as indicated in

dynamic loudspeakers, however, thus eliminating entirely the need for a separate power supply at the loudspeaker location.

With battery receivers the extra current drain due to the field coil of an electrodynamic loudspeaker would obviously be undesirable; for this reason the loudspeakers used in battery receivers will generally have either a balanced armature type magnetic driving unit or a permanent magnet dynamic driving unit. Auto radio receivers use electrodynamic loudspeakers extensively, with the field coil so designed that it can be con-

nected directly to the 6-volt storage battery; permanent magnet dynamic loudspeakers are also used with auto radios.

Elimination of Hum. We have seen how the rectified current supplied to the field coil of the loudspeaker in an A.C. receiver is usually incompletely filtered. Up to a few years ago this ripple current was not objectionable because the average loudspeaker was not able to reproduce sounds as low as the hum frequency of 120 cycles. Recent improvements in loudspeaker design have extended the low frequency response of the loudspeaker well down to the lowest audible sound frequencies; the result is that any ripple currents induced in the voice coil are heard as objectionable hum. This condition arises because magnetic flux produced by the field coil passes through or links with the voice coil, giving the effect of a transformer in which A.C. or ripple current going through the primary induces corresponding A.C. voltages in the secondary or voice coil. The two basic methods used for eliminating hum due to A.C. in the field of a dynamic loudspeaker are: 1, use of a shading ring; 2, use of a hum-bucking coil.

Shading Ring. A large copper ring called a *shading ring* or shading coil is placed around the central core, as shown in Fig. 25A. This shading coil acts as a short-circuited turn which, when A.C. currents flow through the field coil, sets up an out-of-phase A.C. flux in the core to cancel out the effects of the original A.C. flux. The result is that no A.C. voltages are induced in the voice coil.

Hum-Bucking Coil. A more widely used scheme, shown in Fig. 25B, involves winding on the central core a number of turns of wire (usually a few less than are in the voice coil). This extra coil, known as a *hum-*

bucking coil, is connected in series with the voice coil but is wound in the opposite direction. Any A.C. flux which is present in the core induces an A.C. voltage in the voice coil and also in the extra coil. Since these voltages are out of phase and acting in series, they balance or buck each other, and no A.C. current flows through the voice coil to react with the permanent magnetic flux. Circuit diagrams usually indicate when a

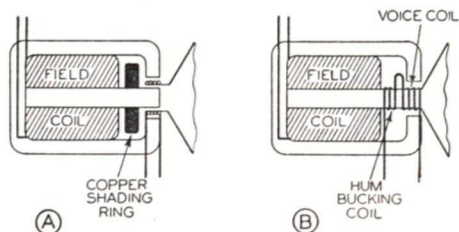

FIG. 25. Here are two methods used by loudspeaker design engineers for overcoming hum which is due to the presence of A.C. components in the field coil current of an electrodynamic loudspeaker.

hum-bucking coil is present in the loudspeaker; typical schematic circuit diagrams illustrating this hum-elimination feature are shown in Fig. 26.

Acoustical Problems of High-Fidelity Reproduction

The output of the average loudspeaker begins to drop rapidly at frequencies above 4,000 cycles. This drop in high-frequency output can be offset to a certain extent by designing the audio amplifier to have a peak response in the high-frequency region, but there is a limit to the amount of treble-boosting which can be incorporated in the audio system without introducing new circuit problems. This is one of the reasons why modern high-fidelity loudspeaker systems usually employ two separate loudspeakers, a woofer, which is capable of giving flat response up to about

3,000 cycles, and a tweeter, which provides satisfactory reproduction of the higher frequencies. Typical response curves for a woofer and a tweeter are shown in Fig. 27. The

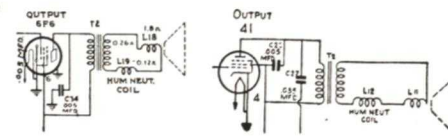

FIG. 26. Schematic circuit diagrams of radio receivers usually indicate, in a manner similar to that shown above, whether a hum-neutralizing (hum-bucking) coil is used in the loudspeaker.

dotted line gives their combined response over the region in which they overlap, and shows that the combined effect is a greatly increased range over which flat response is secured. A low-pass filter (often simply a shunting condenser) is placed in the woofer circuit and a high-pass filter is placed in the tweeter circuit (a series condenser will often suffice) to prevent useless currents from overloading the loudspeakers.

In public address systems, both woofer and tweeter may be of the horn type, or the woofer may be a dynamic cone loudspeaker using an exponential horn baffle, with a horn type tweeter. Deflecting vanes are often built into the tweeter to broaden its directional characteristics.

In home radio receivers the woofer

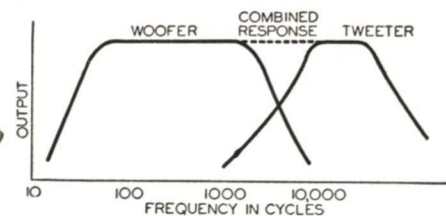

FIG. 27. Response curves for a high-fidelity, two-loudspeaker arrangement.

is usually a dynamic cone loudspeaker mounted in a box baffle having acoustic low-pass phase-reversing construc-

tion, with a tweeter loudspeaker of either the cone type using a crystal driving unit or the trumpet horn type also mounted on the baffle. A typical woofer-tweeter combination in a special box baffle is shown in Fig. 28.

Room Acoustics. Although most people recognize the fact that a theatre or auditorium must be properly treated with sound-absorbing material in order to give natural reproduction of sounds, the average radio receiver owner gives very little attention to the acoustic treatment of the room in which his radio receiver



FIG. 28. A large dynamic cone loudspeaker (woofer) and a horn type tweeter are here mounted on a single box baffle to give uniform response over a wide range of audio frequencies. The inside of the box is lined with sound-absorbing material to prevent standing waves.

is located. It is the duty of the Radiotrician to point out that a room having overstuffed furniture, heavy draperies, and a large, heavy rug is desirable. There will then be sufficient sound absorption to prevent sounds from being reflected back and forth between the walls of the room and various objects in it, and there will be no echo or reverberation effects. The Radiotrician can also recommend that the loudspeaker be pointed or directed in such a way that sound can travel a maximum distance before being reflected. If the radio is in one corner of a room, the receiver should be facing another corner

diagonally opposite, giving a long path through air for the radiated sounds.

High-frequency sounds are so directional in nature and so easily absorbed by rugs and furniture that they should be heard directly rather than after reflection. Some receivers utilize inclined sounding boards or baffles which cause these high-frequency sounds to be directed at an upward angle, away from the floor, for this purpose.

By this time it should be quite clear to you that the securing of high-fidelity reproduction in a radio receiver system or public address system can be best obtained only by proper design of each and every link in the long chain between the microphone in the broadcast studio and the listening location in the home.

Loudspeaker Replacement Hints. Tone controls can compensate to a

certain extent for deficiencies in loudspeaker response, but manufacturers of high-quality receivers will sometimes introduce equalizer circuits in an audio amplifier in order to make the amplifier response peaked in a region where the loudspeaker response is low. The combination response of the system can in this way be made almost uniform for high sound levels. Tone controls then correct for the peculiarities of the human ear at low sound levels. Changing of loudspeakers may therefore alter the performance of a high-fidelity receiver, unless an exact duplicate replacement loudspeaker is used. When the loudspeaker cone in a high-fidelity receiver must be replaced, always use the exact duplicate replacement cone which is supplied by the receiver manufacturer; cone design has considerable influence on loudspeaker response.

Lesson Questions

Be sure to number your Answer Sheet 27FR-2.

Place your Student Number on every Answer Sheet.

Send in your set of answers for this lesson immediately after you finish them, as instructed in the Study Schedule. This will give you the greatest possible benefit from our speedy personal grading service.

1. Why are large flat diaphragms unsatisfactory for loudspeakers?

IT WILL BUCKLE OR BEND

2. What two purposes does a spider serve in a dynamic loudspeaker?

CENTERING THE VOICE COIL AND RETURNING THE VOICE COIL AND CONE TO A NORMAL POSITION.

3. Does mechanical resonance occur at high, medium or low frequencies in dynamic cone loudspeakers?

LOW FREQ.

4. Why is pure piston action desirable in the cone of a dynamic loudspeaker?

TO SECURE FLATTER FREQ RESPONSE.

5. Is an irregular shape of baffle better than a square or round baffle?

YES.

6. Can the natural resonant frequency of a box baffle be lowered by increasing the size of the box?

YES

7. How can the undesirable effects of cavity resonance be reduced in a box type baffle?

ADJUSTING THE CAVITY RESONANT FREQ. TO THE NATURAL FREQ. OF THE CONE SYSTEM.

8. What are the four distinct purposes of the acoustical labyrinth?

1. TO PREVENT CAVITY RESONANCE 2. TO PREVENT STANDING HIGH FREQ. SOUNDS 3. TO GIVE A LOW CUT-OFF FREQ. TO GIVE REINFORCEMENT OF BASS RESPONSE.

9. What are the approximate maximum obtainable efficiencies for a large cone loudspeaker in a box baffle and for a driving unit used with an exponential horn?

FOR A CONE LOUDSPEAKER GREATER 3% AND FOR A DRIVING UNIT USED WITH AN EXPONENTIAL HORN AS HIGH AS 50%

10. What are the two basic methods of eliminating hum due to A.C. in the field of an electrodynamic loudspeaker?

1. USE OF A SHADING RING. 2. USE OF A HUM-BUCKING COIL



DELIVER THE GOODS

“There are 57 rules for success. The first is to deliver the goods. Never mind the rest.”

Like many striking assertions, the quotation above is not altogether true, because there are other rules which cannot be ignored. But there is a lot of truth in this statement.

If you want to be a success in life, deliver the goods. Employers want men who *earn* their salary each and every day—men who have the training required for their particular jobs and actually do apply this training to their work.

You can always excuse yourself if you fail—but nobody else will ever excuse you. Customers may be polite to you and may feel sorry for you, but they will go elsewhere the next time they need radio service work. Employers are equally indifferent to excuses, for they must have good men if they themselves are to deliver the goods.

Make it your business to be where you are needed, when you are needed, with the service or help that is needed. Have all the knowledge which may be required. Be the man who delivers the goods and gets the money.

J.E. Smith