

PHOTOELECTRIC CONTROL CIRCUITS WITH RELAYS

REFERENCE TEXT 25X-1

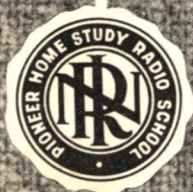

NATIONAL RADIO INSTITUTE

WASHINGTON, D. C.

ESTABLISHED 1914

FOR YOUR REFERENCE LIBRARY

This reference book will prove very valuable should you ever have occasion to deal with photoelectric apparatus, for it contains explanations of the operating principles and characteristics of basic electronic circuits. Each circuit has been carefully selected to show certain fundamental principles which, once understood, can be utilized in designing many other useful circuits of the same general type.

Electronic tubes such as the well-known General Electric Thyatron and the Westinghouse Grid-Glow tubes are being used more and more in industry today; you will find in this text much reference material on this particular subject.

- 1. Types of Relays** — — — — — **Pages 1—13**
How to choose relays; super-sensitive and sensitive relays; heavy duty or power relays; Micro Switches; vacuum and mercury contact switches; time delay relays.
- 2. Care and Adjustment of Magnetic Relays** — — — — — **Pages 13—15**
Prevention of sparking; cleaning contacts; adjusting contacts; ordering relays.
- 3. Photoelectric Controls Using Only Relays** — — — — — **Pages 15—16**
- 4. Vacuum Tube Amplifiers for Sensitive Relay Operation** — **Pages 17—23**
Rise and fall circuits of the forward and reverse types; impulse control circuits; light differential circuits.
- 5. Gas Tubes for Direct Power Relay Actuation** — — — — — **Pages 24—28**
Hot and cold cathode types.

COPYRIGHT 1947 BY NATIONAL ELECTRONICS INSTITUTE, WASHINGTON, D. C.
(an affiliate of the National Radio Institute)

PHOTOELECTRIC CONTROL CIRCUITS WITH RELAYS

Types of Relays

YOUR study of light-sensitive cells has shown that these "electric eyes" change their electrical characteristics when the light on them changes. Thus, light causes a photoconductive cell to change its resistance, this change being converted into either a current or voltage change by the cell circuit; a photovoltaic cell actually produces an e.m.f. directly, which is generally used to cause a current change in an electrical circuit; a photoemissive cell controls the electron flow in its circuit, thereby producing changes in voltage and current. Now, the current changes are quite small—several milliamperes at most, and usually of the order of microamperes. To control electrical apparatus with light-sensitive cells, it is usually necessary to build up these comparatively small current changes in some manner.

In most practical control circuits, the impulse or electrical power change originating at the photoelectric cell actuates an electromagnetic relay whose contacts either open or close the circuit to the device which is to be controlled by changes in light. The greater the current required by the device, the greater must be the pressure of one relay contact against the other, the larger must be the contacts, and the greater must be the power required to operate the relay. A sensitive relay can be used for small currents, but a husky power relay which has large contacts is needed if heavy currents flow.

Many different schemes for linking the light-sensitive cell with the power relay have been introduced. Electromagnetic relays connected in succession, so the contacts of one control the input to the next, are widely used. For example, a photovoltaic cell may actuate a super-sensitive relay which controls a sensitive relay, and this secondary relay in turn operates the final heavy-duty relay.

Because super-sensitive relays are expensive and require considerable attention, many methods have been developed to eliminate their use. A voltage change in the cell circuit can be amplified sufficiently by one or more vacuum tube amplifiers to operate sensitive or heavy-duty relays. The voltage change originating at the cell can also be applied between the grid and the cathode of a gas triode (such as a "grid-glow" or a Thyatron tube), and a heavy-duty power relay can be inserted in the plate circuit of the gas triode. In many cases the device being controlled can be connected directly into the plate circuit of the gaseous tube, in place of the power relay.

Thus, you may find between the light-sensitive cell and the controlled device either an amplifier (containing one or more gaseous or vacuum type amplifier tubes), an electromagnetic relay, or a combination of the two. The intervening circuits may impart special characteristics to the complete photoelectric control

unit. In general, however, the final action is to open or close the circuit at the desired time interval after the light on the cell has changed by a certain definite amount.

Choosing Relays. In selecting a relay for a particular application, certain fundamental facts must be considered. How much current is required to make the relay contacts close? This current is called the *pull-up* current of the relay. At what value of current will the relay contacts open? This is called the *drop-out* current. Other important fac-

the relay circuit must be considered, for relays are generally designed for either d.c. or a.c. use, but not for both. (D.C. relays are usually more sensitive than a.c. relays.) The ohmic value of the relay coil is another important factor, for the voltage drop across the coil must be considered in the design of the control circuit.

Other factors affecting the choice of a relay are the current, the voltage, and the nature of the load in the circuit being controlled. The contacts must be able to carry and break the current through the circuit without

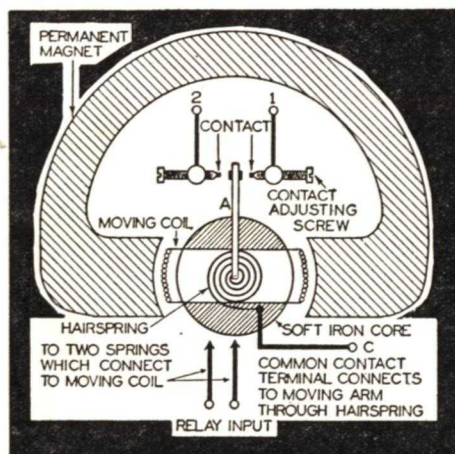

FIG. 1. A super-sensitive relay is basically similar to a moving-coil type meter; in fact, it is frequently called a meter-type relay.

tors are: How long does it take after the current or voltage reaches the pull-up value before the contacts close completely? How much time elapses, after the relay current is reduced to the drop-out value, before the contacts are opened? Where rapid counting or fast action is required, fast relays are used; for certain jobs, such as illumination control applications, extremely slow relays are needed; where light changes on the cell are small, the difference between pull-up and drop-out currents must be small. The nature of the power supplied to

serious arcing or sparking. The voltage must not be so high that current will jump across the contacts when they are open. When the load is inductive, the amount of current which can be carried is reduced unless anti-sparking filters are used. Even then, the high surge voltage produced by breaking an inductive circuit may cause arcing across the contacts if they are too close to one another in their open position.

Now that you know what the important characteristics of a relay are, let's make a detailed study of the

various types of relays used for photoelectric and electronic control systems.

SUPER-SENSITIVE RELAYS

From a practical viewpoint, super-sensitive electromagnetic relays are really modified moving coil type microammeters, with platinum-iridium contacts mounted on the moving pointer, and with adjustable contacts (one on each side of the pointer) mounted on the meter scale. Platinum-iridium contacts are used because this alloy does not oxidize or tarnish in air, and resists the pitting (eroding) action of the current.

The basic arrangement of a typical super-sensitive relay is shown in Fig. 1. The two moving coil terminals are connected into the controlling circuit (light-sensitive cell circuit), and the remaining three terminals, going to contacts 1 and 2 and to pointer A, are for the controlled circuit. An increase in current through the relay coil will send arm A to contacts 1 or 2, depending on the direction of current flow in the coil circuit. The sensitivity of this relay depends on the strength of the permanent magnet, the number of turns on the coil, and the spring restoring torque (twist), just as with ordinary meter movements.

► One commercial form of this relay, the Weston meter-type relay, is shown in Fig. 2. The minimum current required to close the contacts is 15 microamperes, and the contacts are rated to handle up to 200 milliamperes (non-inductive load) at 6 volts.

► A super-sensitive relay of this type can be used in the following three ways:

I. With *no* current flowing through the relay coil, arm A (Fig. 1) is set midway between contacts 1 and 2, so

a positive current (a current flowing in such a direction that it causes the pointer to swing clockwise) will move arm A to contact 1 and a negative current (making the pointer swing counter-clockwise) will move the arm to contact 2. The closer together the contacts are placed, the smaller is the current required to move the arm over to one of the fixed contacts.

II. Arm A is made to center itself halfway between contacts 1 and 2 for a *definite* value of coil current, making contact with 1 when the current exceeds this value and making contact with 2 when the current falls below this mid-value. Moving contacts 1 and 2 closer together gives relay action for smaller changes in current.

III. Arm A is set to make contact with 2 for all coil currents from zero up to a certain definite value in the relay range; currents above this value then move the arm over to contact 1. The reverse of this action is also possible.

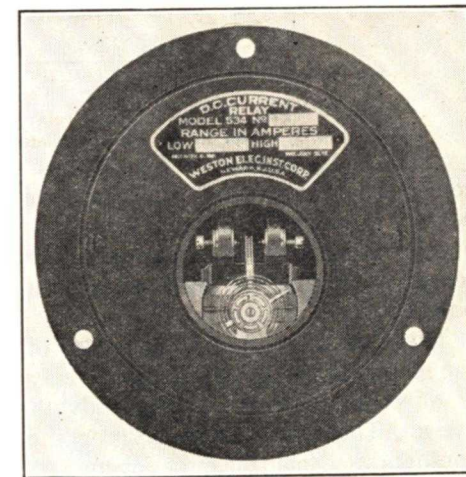

Courtesy Weston Electrical Inst. Co.
FIG. 2. The Weston model 534 meter-type relay, capable of operating on coil currents as low as 15 microamperes.

► The speed of operation of meter type relays can be increased by moving the fixed contacts closer together.

Only small currents and voltages, usually not over 200 milliamperes at 6 volts, can be controlled where fast operation is desired. There must be no appreciable inductance in the contact circuit which would cause serious arcing.

Any current or voltage range for the moving coil of the relay can be obtained by using shunts and multipliers. Super-sensitive relays having ranges below 200 microamperes can be connected directly across dry or wet type photo-voltaic cells, or placed in series with a battery across photoconductive

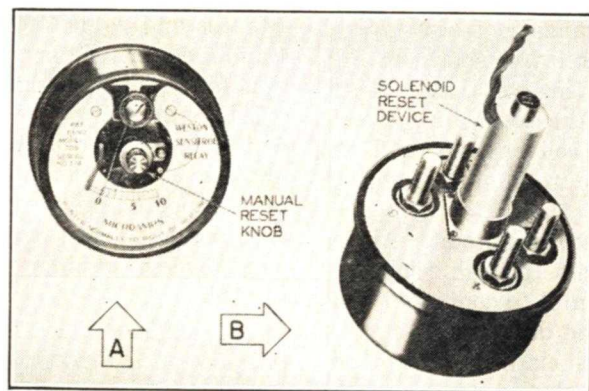

Courtesy Weston Electrical Inst. Co.
 FIG. 3. The Sensitrol relay. The type at A has a manual reset knob, while the one at B is reset magnetically.

cells. The contacts of the relay are usually connected through a 4.5- to 6-volt battery to the coil of a sensitive relay, which may in turn actuate a power relay.

The extremely high sensitivity of the meter type (super-sensitive) relay is offset by a number of disadvantages. There is a tendency for the contacts to "chatter," or open and close repeatedly, when the actuating coil current is just about enough to make or break a contact. This results in arcing, faulty operation of the relay, and eventual destruction of the contacts. To overcome this chattering without depriving the relay of its

low current pull-up value, the Weston Electrical Instrument Corporation has introduced their so-called *Sensitrol* relay, shown in Fig. 3A.

The basic construction of this relay is like that shown in Fig. 1, except that a small soft iron piece or "rider" replaces the contact points on moving arm A, and a small but powerful permanent magnet replaces the contact at 1. When the arm swings over to the right it is snapped up against the face of the magnet, making a solid contact. External force must be applied to the pointer to free the rider

from the magnet and break the contact. This can be done in either of two ways: by turning the reset knob in the center of the relay, which pushes the pointer back to its no-current position, or by using a solenoid (electromagnet) to reset the pointer electrically. The solenoid type Sensitrol is pictured in Fig. 3B.

Sensitrol relays can be obtained in many different types, to open or close a circuit on either an increase or a decrease in current. These relays usually are used for installations where repeated or continuous control is unnecessary, such as in locations where an attendant can reset the relay after

each closing. However, time relays can be used in conjunction with the solenoid type Sensitrol to reset the relay automatically. Although the apparatus required is quite expensive, it gives the only practical solution to certain types of control problems.

SENSITIVE RELAYS

Relays of the sensitive type require currents of from .5 to 3.0 milliamperes for their operation. This type of relay is used in the plate circuit of a vacuum tube amplifier whose grid is connected to the control element (light-sensitive cell, thermostat, beat-frequency oscillator, etc.), and also in circuits where it is controlled by the contacts of a super-sensitive relay.

Fig. 4 shows the construction of a typical sensitive relay. In general, a sensitive relay consists of a soft iron armature, pivoted at one end, which is attracted to the iron core of an electromagnet when the required current is passed through the electromagnet coil. Contacts are placed on the free end of the armature.

The electromagnet consists of a large number of turns of No. 30 to No. 40 B. & S. gauge enamelled or insulated copper wire, wound on a bobbin which slips over one leg of a U-shaped core. These coils are designed to have the greatest number of ampere-turns for a given operating voltage and current. The weaker the rated pull-up current of the relay, the greater must be the number of turns on the coil; increasing the turns means increasing the resistance of the coil. Relay coils have resistances varying from 1 to 10,000 ohms, depending upon the operating current. Sensitive relays for photoelectric work ordinarily have resistances of from 1,000 to 8,000 ohms.

Relay coils generally are rated according to the power in watts required

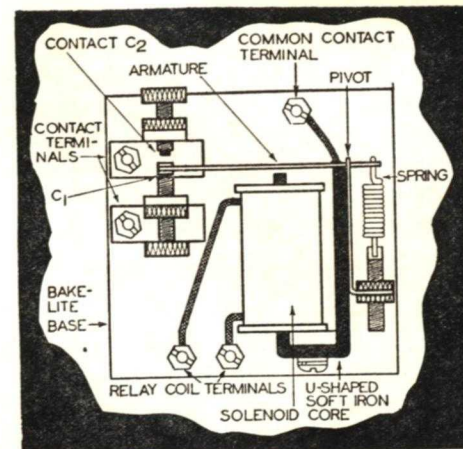

FIG. 4. A typical sensitive relay. The "common contact" terminal connects to the armature.

to pull up the armature and close the contacts. This wattage rating allows relays of different voltage and current ratings to be compared as to sensitivity.

Pivoted at one end of the U-shaped core (Fig. 4) is the soft iron armature which is attracted to the U-shaped core when the solenoid is excited with sufficient current. The armature is normally held against contact C₂ by the action of the spring; when the pull-up current value passes through the coil the armature is pulled up against C₁. Thus, by making the proper connections to contacts C₁ and C₂, the opening and closing of one circuit can be controlled by the relay, or two separate circuits can be controlled.

It is important that the armature and the core of the relay coil be made of material which will not retain its magnetism when the current falls below the pull-up value. Therefore, special alloys of iron with silicon are used; they change their magnetism as the magnetizing current changes and lose practically all magnetism when the current drops to zero. These alloys have a high permeability, which

means that they produce a large magnetic attraction for low values of ampere turns. The lower the electrical power required to pull up the armature, the more sensitive is the relay. Notice that one end of the armature (in Fig. 4) rests against one of the poles of the U-shaped core; this re-

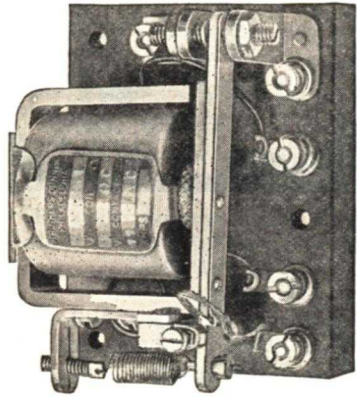

Courtesy Struthers-Dunn, Inc.

FIG. 5. The Dunco CXB51 sensitive relay, which can be obtained with coils of various voltage and current ratings.

duces the reluctance of the magnetic circuit, giving greater sensitivity.

► The armature must be properly balanced so it will move freely without wasting any of the attractive force, if maximum sensitivity is to be obtained. The electrical connection to the armature is ordinarily made at some point on the U-shaped core, with current passing through the pivot and out along the armature to the double contacts. Pigtails (flexible leads) are sometimes used to bridge the pivot and give a more dependable electrical connection. Sensitive relays of this type will handle about 2 amperes at 110 volts a.c. or $\frac{1}{4}$ ampere at 110 volts d.c., provided that the loads are non-inductive. (When there is an inductive load, less current can be handled. However, placing a condenser or a condenser-resistor filter across the contacts reduces the sparking and allows currents more nearly

the rated values.) A typical sensitive relay is shown in Fig. 5.

The Telephone Relay. Another type of sensitive relay, shown in Fig. 6, is commonly known as a *telephone type relay*, because it is widely used in telephone circuits. The coil of this relay is about 3 inches long and 1 inch in diameter, and has a cylindrical soft iron core. At one end of the core, a rectangular soft iron armature is so pivoted that it is attracted to the core when current flows through the coil. There are no contacts on the armature. Instead, there is an armature lever which has an insulated bushing at its tip. When the armature pulls up, this lever pushes against spring steel blades on which the contacts are mounted; these contact blades can be arranged either to open or close circuits when the relay operates. The blades are very similar to those used on plug-in telephone jacks. Any number of combinations of make-and-break circuits is possible. A few of the fundamental contact possibilities are shown in Fig. 6. When the armature button moves in the direction of the arrow, the indicated "make-and-break" or "open-and-close" action takes place.

The telephone relay is an extremely flexible device. With certain modifications it can be adapted to any practical speed or function. It will pull up in .02 to .05 seconds and drop out in the same time. A residual magnetism screw, set into the armature to prevent it from sticking to the core when coil current is zero, can be adjusted to reduce the movement of the armature and thus speed up its action. This screw, of course, must be made of non-magnetic material.

The drop-out time of the telephone relay can be increased by preventing a rapid decrease in magnetic flux through the core. For instance, a medium speed relay is obtained by

placing a copper sleeve over the iron core (between the coil and the core). A slow speed relay is obtained when a heavy copper washer is slipped over the end of the core. The thickness of the washer determines the speed of operation of the relay. The principle of mutual induction explains why relays can be slowed up in this way; the copper washer or sleeve is really a single turn coil of low resistance, mutually coupled magnetically (by the core) to the relay coil. The thicker the washer, the lower its resistance and the longer it can prevent a change in the flux through the core.

► Super-sensitive relays are generally of the fast type. However, sensitive relays are made with fast, medium, and slow operating speeds. Fast, sensitive relays are recommended for use in the plate circuit of a vacuum tube. ► The most dependable relays have a drop-out current which is about one-half the pull-up current; this gives a relay differential (ratio of drop-out current to pull-up current) of 50%.

Designing them this way provides a more positive action, particularly when small current variations are present. Once the relay closes, it is held firmly closed until the current falls to the drop-out value. Relays with differentials of 15% to 25% are available, but these usually require more frequent attention. They operate on small differences in exciting current, but this low differential makes for a less positive relay with a tendency to chatter.

A.C. and D.C. Operation. The sensitive relay can be used in a.c. or pulsating d.c. current control circuits if certain precautions are observed. It is often an advantage to use a.c. if it is possible to do so, for a.c. voltages are almost always easier to obtain in the exact values required, whereas batteries change in voltage and require constant replacement.

A telephone relay (designed specifically for d.c. use) may be used in the plate circuit of a tube which is rectifying a.c., provided a condenser is

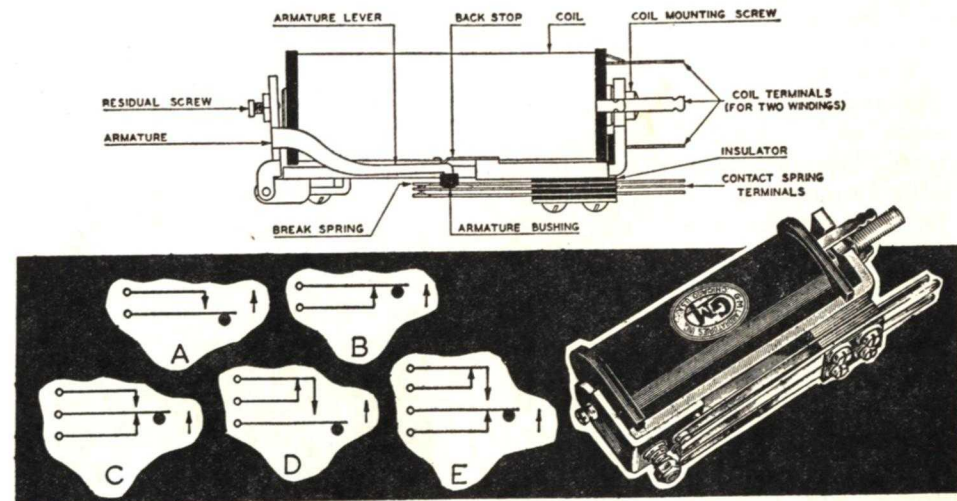

FIG. 6. The telephone-type relay, so named because it is widely used in telephone work as well as in electronic control apparatus. Almost any contact arrangement is available; several are shown here. These basic contact arrangements are: A—make; B—break; C—break before make; D—make before break; E—break and make before break. A "make" arrangement closes a circuit when the relay is energized, while a "break" style opens a circuit.

shunted across the relay coil. The condenser and the coil then act as a filter to smooth out the pulsations in the current. The lower the coil resistance, the larger must be the condenser capacity to prevent contact chatter. Always use the smallest capacity which will prevent chatter. A 2-mfd. condenser is about correct for a 5,000-ohm relay coil.

► Special types of relays are available for use in a.c. circuits. These are generally less sensitive than d.c. types, for power is lost because of *eddy currents* and *hysteresis*. The cores and armatures of some a.c. relays are made up of very thin sheets of silicon iron,

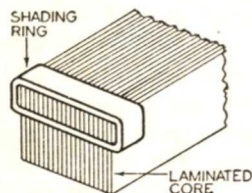

FIG. 7. In order to prevent chatter when relays are operated on a.c., a heavy copper shading ring, like that shown here, is forced into a slot cut into that end of the laminated iron core which faces the armature.

like audio transformers, while other types use solid cores having one or more slots along one side to reduce eddy currents. To help prevent chattering, the mass (weight and shape) of the moving armature, and the spring tension are made such that the moving system has a vibration period which is less than the frequency of the exciting current. As an additional check on chattering, that pole of the core which faces the armature has a split end, in which is imbedded a heavy copper ring, called a "shading" ring or coil; this is shown in Fig. 7. This ring acts like a short-circuited secondary winding, its induced current producing a flux which holds the arm-

ature down during that part of the cycle when the current (and the main flux) drops to zero. All these factors tend to make a.c. relays less sensitive and more expensive than d.c. types.

HEAVY-DUTY OR POWER RELAYS

When the power that is to be turned on or off by a relay exceeds 200 watts a.c. or 25 watts d.c. (the maximum values which can be handled by the *average* sensitive relay) a power relay, controlled by a sensitive relay, is generally used to handle it.

The coil of a power relay requires a d.c. input power of about 2 watts, in general, for satisfactory control of up to 1,000 watts a.c.; if a 100-volt d.c. source is used to excite the power relay coil, the operating or pull-up current ($I = P/E$) will be $2 \div 100$ or .02 ampere (20 milliamperes). The resistance of the relay coil ($R = E/I$) should therefore be $100 \div .02$ or 5,000 ohms in this case. The required resistance for any relay coil can be figured in this manner. Generally, a.c. relays require a higher power input than d.c. relays.

The principle of operation of the power relay is essentially like that of the sensitive relay. The same precautions are taken to prevent chatter on

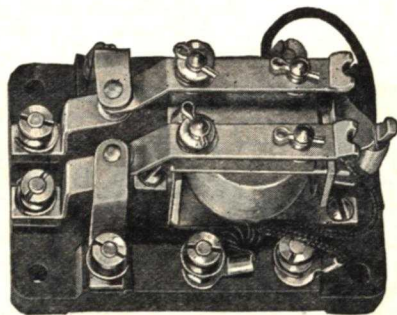

Courtesy Struthers-Dunn, Inc.

FIG. 8. Dunco midget heavy-duty relay (Type CDBX1), having two contact blades mounted on the clapper type armature to give double-pole double-throw operation.

power relays designed for a.c. excitation. A typical power relay (also called an auxiliary relay) is shown in Fig. 8. It has a rectangular clapper type armature pivoted in front of an electromagnet. The clapper carries one or more contact arms which move between fixed contacts. The one shown is a double-pole, double-throw switching relay: one circuit closes when the relay pulls up, the other closes when the relay drops out. A large number of make-and-break combinations are possible. In circuits where a super-sensitive relay controls a sensitive relay which, in turn, actuates the power relay, the first two relays are essentially simple make-and-break types, which the power relay furnishes the desired switching (often quite complex).

Another form of power relay, one which can apply heavy contact pressures, makes use of the suction or minimum reluctance action of a magnetic circuit. A diagram of such a relay is shown in Fig. 9. When a.c. or d.c. is fed to the relay coil, the armature has a tendency to take a position which will make the reluctance of the magnetic circuit a minimum (by making the air gap between the armature and the poles as small as possible). Thus,

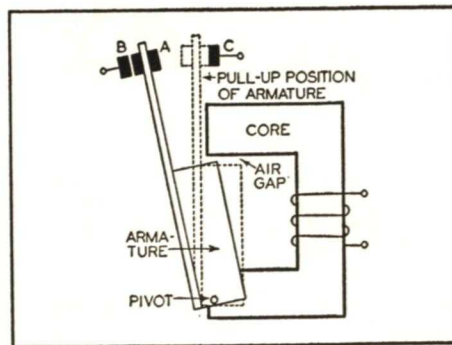
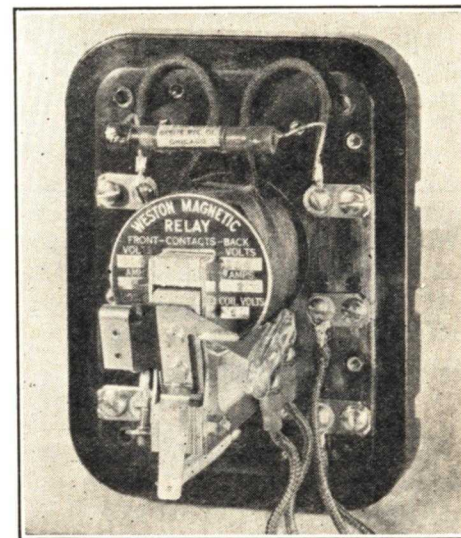

FIG. 9. Diagram illustrating the principle of operation of the minimum reluctance type of power relay. Dotted lines show pull-up position of armature.

when the relay coil is actuated, the armature takes the position shown by the dotted lines and the contact arm moves from B to C.

Both sensitive and power type relays can be made with a small latch



Courtesy Weston Electrical Inst. Co.

This power relay uses mercury tube switches instead of air contacts. As many as four separate mercury switches may be mounted on the relay, which is of the minimum reluctance type.

or mechanical lock which will hold the armature in position once it has been attracted to the core. Relays with this device are known as *latch-in relays*; they must be released either mechanically (by pushing on the latch) or by an auxiliary electromagnet whose armature is attached to the latch. Latch-in type relays are useful when the relay-actuating current is an impulse (produced by pushing a button or interrupting a light beam) which must keep mechanisms in operation until the desired condition has been reached. The latch can then be released by some type of limit switch, opening the relay in readiness for an-

other control operation. For example, when an intruder passes through a light beam, the photocell, through its relays, can be made to ring a bell continuously until the owner of the establishment releases the latch-in relay.

SPECIAL RELAYS

Although unique control arrangements can be obtained by using sensitive and auxiliary relays together, the

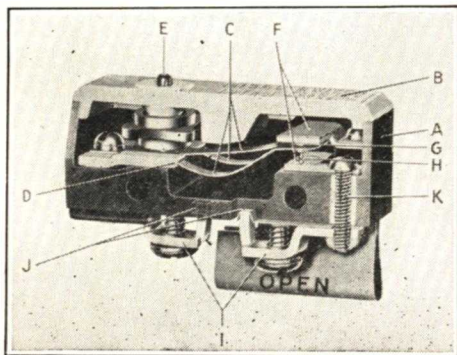

Courtesy Micro Switch Corp.

FIG. 10. A cut-away view of a Micro Switch. A slight pressure on the plunger (E) either opens or closes the contacts, depending on the contact arrangement. The parts shown and labeled are: A—part of the case or enclosure; B—the top of the unit; C—the spring arms; D—the anchoring blocks for the ends of the curved springs; E—the plunger which actuates the switch; F—the fixed contact faces; G—the movable contact; H—not a part, but the distance the contact must travel to touch the lower face; I—the terminals; J—the terminal anchors; K—a feed-through screw which ties the contact to a terminal.

use of combinations of relays in this way is not entirely satisfactory in many cases, for each relay is a potential cause of failure of the entire system. The ideal relay is one sensitive enough to operate on extremely low power inputs, yet capable of controlling large amounts of power. The Micro Switch and the mercury type

contacts, when used on ordinary sensitive relays, closely approximate the ideal relay.

A **Micro Switch** is shown in Fig. 10. This switch operates with a snap when a pressure greater than 14 ounces is applied to the operating plunger, and releases with the same snap action when the pressure is reduced to about 4 ounces. The actual travel of the plunger is approximately .0004 to .002 inch. The moving contact is attached to one flat spring and two curved springs. The flat spring produces a downward force on the moving contact, while the curved springs produce an upward force on it. In the normal position, the downward force of the flat spring is slightly greater than the upward force of the curved springs. However, when the flat spring is depressed by the plunger, its force on the contact is decreased, and the lower springs bring the contact up to the fixed contact with a snap. Switches of this type are available in a number

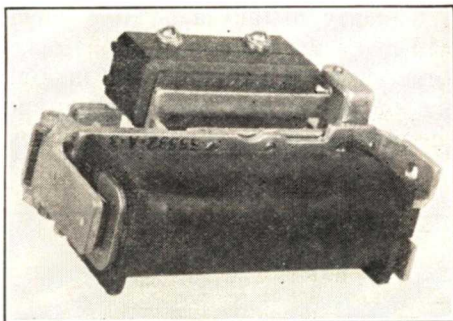

Courtesy Automatic Electric Co.

A combination of a telephone-type relay and a Micro Switch. The relay operates the plunger of the Micro Switch.

of simple make-and-break combinations.

Vacuum contacts are used extensively on relay installations where sparking at contacts may cause an ex-

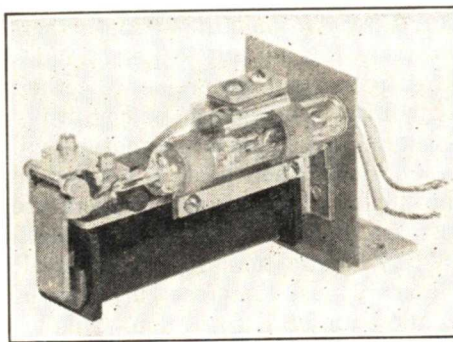

Courtesy Automatic Electric Co.

FIG. 11. Vacuum contact switch mounted on telephone-type sensitive relay. Insulated knob on armature at left presses against glass lever which extends into the glass vacuum tube and operates the contacts which are inside.

plosion and fire. Reasonably large currents can be controlled with a sensitive relay and the special vacuum contact shown in Fig. 11. The contact points, mounted in a glass tube from which all the gas has been evacuated, are operated by a glass lever which acts through a flexible seal, lifting the movable contact. Since the contacts are in a vacuum, in which there is no gas to cause ionization or arcing, only a small gap is required between them. The contacts therefore have a long life. As much as 6 amperes at 220 volts a.c. or d.c. can be controlled by the unit shown, regardless of whether the load is inductive or resistive, and as many as 40 make-and-break operations per second can be made.

Mercury Contact Switches. If you place a quantity of mercury on a flat sheet of glass you will observe that the mercury remains in a globule and that the slightest tilt to the glass will cause the mercury to move. This characteristic, together with the fact that mercury is a metal and therefore a good electrical conductor, has resulted in the *mercury contact switch*. A quantity of mercury is placed in a small capsule-shaped glass tube hav-

ing two (or more) contact wires sealed into the glass. The tube is sealed after air is pumped out; an inert gas is sometimes placed in the tube after evacuation, to prolong its life. When the switch is tilted as shown in Fig. 12, the mercury makes contact with only one wire or electrode, but in a level position the globule of mercury spreads out over both electrodes, closing the circuit between them. If both electrodes are placed at one end of the tube, tilting the switch in that direction will close the circuit. Many other arrangements of two and more contacts are possible. Mercury tube switches are available in many different types, some with mercury-to-metal contacts and others where the mercury pools themselves form the contacts; some require large, others require small angles of tilt. Switches which must carry large amounts of power in general require more mercury, heavier contacts, a larger angle of tilt, and larger forces to cause the tilt.

Mercury tube switches can be mounted on sensitive or low powered relays, in combinations capable of controlling up to several kilowatts of power. As many mercury tube switches can be attached to a relay as are required for the control operations, when the desired contacts cannot be made by a single switch.

Mercury switches have a disadvantage in that they must be mounted

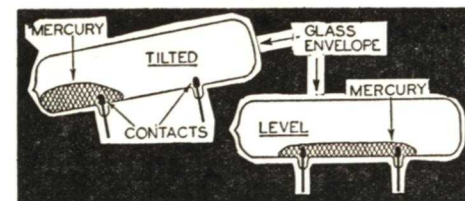

FIG. 12. Tilted and level positions of a simple mercury switch. When the switch is in the level position, a globule of mercury makes electrical connection between the two contacts.

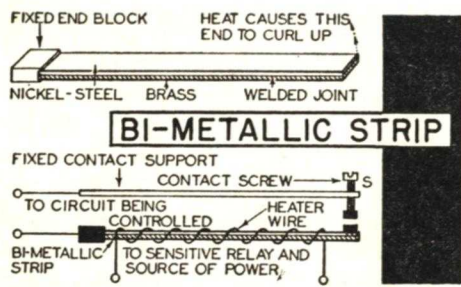

FIG. 13. Basic principles of the bi-metallic strip type time delay relay are illustrated here. The four connections are often reduced to three by attaching one heater wire to the bi-metallic strip.

“level” and cannot be used in places where they would be subject to jarring. The vacuum switch is better for these cases.

Time Delay Relays. Quite often a relay is needed which will not close its contacts for a definite interval of time (5 seconds to 3 minutes) after the coil is energized. For example, a time delay relay is needed in certain illumination control systems. Here a single photocell is made to operate two sensitive relays, one of which turns on lights when room illumination drops below the desired value, and the other turns off the room lights when the photocell “sees” too much light. Clearly, steps must be taken to prevent either small clouds that momentarily hide the sun or passing objects from flashing the lights on and off. The usual solution is to use the sensitive relays to control time delay relays, which, in turn, control the light circuits. These time delay relays require current for a definite period of time before their contacts close.

Most time delay relays are heat-operated mechanisms. The control current supplied to one passes through a resistance wire, and the heat developed causes some mechanical motion which is used to close or open contacts. Usually, this motion is pro-

duced by a *bi-metallic strip* (a thermostat). If a nickel-steel strip and a hard brass strip are welded together, as in Fig. 13A, and one end is firmly anchored, a very positive motion will be obtained when heat is applied to the device. For a given temperature increase, the brass increases in length 18 times more than the nickel-steel; the strip must therefore curl upward to allow the brass to stretch. This bi-metallic strip can be heated by sending current through a coil of resistance wire wound around it. If contacts are placed on the free end of the strip and fixed contacts mounted on either side, the strip can be used to open or close a circuit. The time required to make contact can be changed by adjusting the positions of the fixed contacts. The contact is usually mounted on an adjusting screw, as at *S*.

Figure 13B shows a simple but effective time delay relay requiring about 6 volts of d.c. or a.c. for its operation and intended for use with a

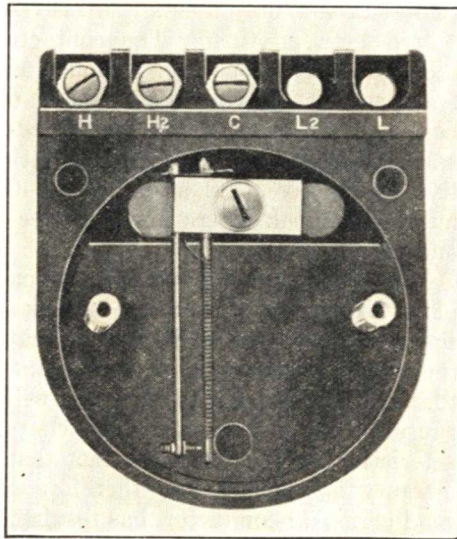

Courtesy Weston Electrical Inst. Co.
A time delay relay with the cover removed. The heater coil operates from 6 volts d.c.

sensitive relay. The time delay contacts will handle about 25 watts a.c. ($\frac{1}{4}$ ampere at 110 volts). If more power is to be handled, a heavy-duty relay must follow the time delay re-

lay. This relay always requires 60 seconds for a complete make-and-break operation, but it can be adjusted to make contact in an interval varying from 15 to 45 seconds.

Care and Adjustment of Magnetic Relays

Prevention of Sparking at Contacts. To obtain long contact life from relays, sparking must be reduced to a minimum. The most effective protection for a super-sensitive relay, where sparking is especially serious, is to connect a condenser *C* and a resistor *R* in series across the relay contacts, as shown in Fig. 14A. The time constant of the combination of *R* and *C* should be much lower than the speed of the relay (*R* in ohms times *C* in mfd. gives time in microseconds; divide by 1,000,000 to get time in seconds). In general, a 1 mfd. condenser in series with a 100-ohm resistor will be satisfactory. In a.c. circuits the reactance of the condenser must be sufficiently high (the capacity low) so current passing through the condenser will not operate the power relay or other device being controlled by the contacts. The condenser should have a working voltage of at least 400 volts for circuits using 110 volts or less.

When the relay contacts are connected into the coil circuit of another relay, it is wise to shunt the coil of the second relay with a resistor like *R_s* in Fig. 14B whose resistance is at least five times the coil resistance, so that it will not appreciably raise the pull-up current. This resistor tends to

neutralize the inductance of the relay coil and lessen the tendency towards sparking at the contacts which are in series with that relay coil.

Cleaning Contacts. To begin with, relays exposed to the air should be kept in dust-proof housings or at least partially protected from dust, chemical fumes, and foreign particles. Relays should be cleaned regularly with an air bellows or air pressure line. All contacts and moving parts should be cleaned with carbon tetrachloride (Carbona). When flat type contacts become pitted or corroded, they should be filed flat and bright by placing a thin file (such as that used in cleaning automobile distributor contacts, or a jeweler's file) between the contacts, squeezing the contacts together and slowly drawing out the file, repeating the process as often as nec-

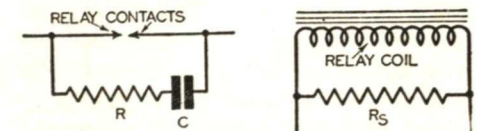

FIG. 14. Spark filters. The R-C filter A will tend to prevent sparking at the relay contacts. The resistor across the relay coil at B will reduce relay contact sparking when the relay is used to control the coil current.

essary. When the contacts are shaped (rounded or cylindrical) they should be polished with fine "crocus" cloth. Never oil or grease the moving parts of relays, for they are designed to give free action without a lubricant. These instructions apply only to sensitive and power relays; super-sensitive relays must be handled just as carefully as meters.

Adjusting Relay Contacts. All relays come from the manufacturer properly adjusted for pull-up and drop-out current. Tampering with the adjustments should be avoided, but if adjustments are necessary, the following general rules, which deal specific-

2. Reduce the coil current to the desired *drop-out* value and gradually increase the spring tension until the armature drops out.

3. Turn out the drop-out stop, adjust the current to the desired *pull-up* value, then slowly turn in the drop-out stop, bringing the armature nearer to the coil core, until the armature pulls up. The relay is now properly adjusted for the desired pull-up and drop-out currents.

Check the adjustments by varying the current back and forth to the drop-out and pull-up values, to be sure the relay operates properly. If the armature drops out sluggishly, increase the armature gap and repeat adjustments 2 and 3. If the armature pulls up sluggishly, turn in the drop-out stop a little more.

► Always adjust the relay in the position in which it is to be used. A relay may be adjusted just as easily in its final operating circuit, following the procedure given above while using operating conditions for pull-up and drop-out currents.

Ordering Relays. In ordering relays or getting a quotation as to cost, you must decide first upon the type (meter, sensitive, power, mercury contact, etc.) and the manufacturer, after studying the catalogs of different relay manufacturers. You will find that each type of relay can be secured in a number of different voltage and current ratings. In most cases, it is best to let the manufacturer use his own judgment in making the final choice. When you write to a manufacturer, always supply at least the following information:

1. Catalog number and name of the type of relay you desire.
2. Pull-up and drop-out current (or voltage) values required.
3. Whether the exciting current will be a.c. or d.c.

4. Contact arrangements desired.
5. Power to be handled by contacts (voltage and current); whether a.c. or d.c. power is used, and whether or not load is inductive.

6. Speed of pull-up and drop-out, or time for one complete operation (if important in your case).
7. Special information as to how relay will be used.

Photoelectric Controls Using Only Relays

Inasmuch as a super-sensitive relay will operate on currents below 1/4 milliampere—currents which photovoltaic and photoconductive cells will produce with normal changes of light—these cells may be connected directly to super-sensitive relays. Photoemissive cells, however, are not suitable for direct connection to a relay, as the safe current which they can pass is generally insufficient for relay actuation.

While some photoconductive cells will pass enough current to actuate a sensitive relay directly, the photovoltaic cell (which can supply ample

between a photovoltaic cell and a relay is best demonstrated by the circuit shown by the heavy lines in Fig. 16. *P* is a Weston Photronic Cell and *R*₁ is any one of the 0-200 microampere super-sensitive (or meter type) relays. The contacts of relay *R*₁ control the exciting current to relay *R*₂, which can be either an ordinary sensitive relay or one with micro-contacts, vacuum, or mercury contacts. When the control circuit is to be on intermittently and only for short intervals, the battery *B* may be used, but a.c. should be used if the control circuit is to operate frequently. If the sen-

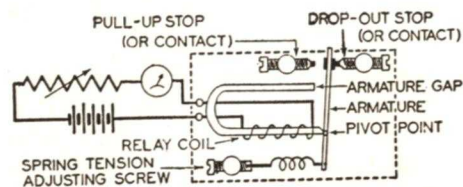

FIG. 15. A test circuit used to send an adjustable current through the relay coil of a sensitive relay. This circuit is necessary in order to adjust the relay properly.

cally with sensitive relays, will be helpful:

1. Connect the relay in the test circuit, shown in Fig. 15, which is capable of supplying enough direct current to operate the relay. With a current near the pull-up current flowing through the coil, loosen the spring tension screw, then adjust the pull-up stop (this is also the pull-up contact in most cases) so the gap (called the armature gap) between the armature and the soft iron core or pole piece is about .002". If there is a copper cap or copper stud in the pole piece (to prevent the armature from sticking), adjust for zero air gap, being certain that good contact is being made between the armature and the pull-up contact.

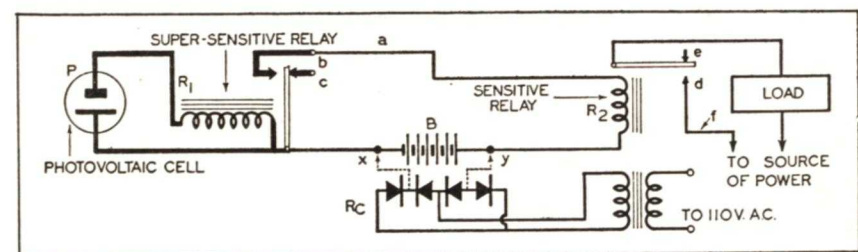

FIG. 16. Typical photovoltaic cell circuit using two relays.

current for a *super-sensitive* relay) is the only type of cell which is used *commercially* to operate a relay directly. The current outputs of the photoemissive and photoconductive cells are first amplified by vacuum or gaseous tubes in practical *commercial* equipment.

The simplicity of the connections

sitive relay is of the d.c. type, a voltage step-down transformer and a full-wave rectifier can be used to permit operation on a.c.; if relay *R*₂ is of the a.c. type, a step-down transformer is all you need. Simply remove battery *B* and connect the rectifier unit or the step-down transformer to points *x* and *y*. In the circuit shown in Fig. 16, the

minated normally, the resistance of the cell reduces in value. This causes an increased current flow through the 3-megohm resistor. The positive pulsations on a.c. (or the normal drops on d.c.) make the grid end of this resistor positive. The grid, originally highly negative, thus becomes more positive with respect to the cathode, plate current increases, and the relay pulls up. Potentiometer K_2 should be adjusted so that just enough plate current will flow to make the pull-up contact pressure strong enough to prevent chattering.

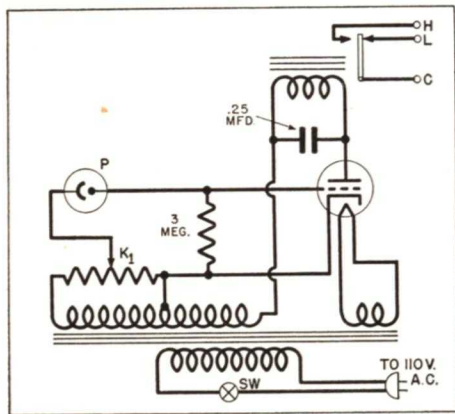

FIG. 18. A reverse circuit for a photoemissive cell.

The negative half of the a.c. cycle is ignored, as the tube does not pass current when the plate is negative. Thus, the average *positive* value across the 3-megohm resistor sets the pull-up point.

The control action of this circuit, then, is that the relay pulls up when one level of illumination is reached and drops out when the illumination drops below another (lower) level. If the illumination is high at first, then decreases, the relay will remain pulled up until the drop-out level is reached. Conversely, if the illumination is low at first, then increases, the relay will remain out until the pull-

up level of illumination is reached. ► If the photoemissive cell (used in Fig. 17B) is a gas type, it should never be operated at a peak voltage greater than that recommended for the cell used, and a resistance of at least one megohm should be in series with the cell to limit the current in case the voltage is accidentally exceeded. (Note that a 3-megohm resistor serves for this purpose in Fig. 17B.) To increase its life, the photoconductive cell (Fig. 17A) should be operated at the minimum voltage which will give satisfactory control.

► In general, in a forward circuit, the C bias voltage (controlled by K_1) is varied to cause drop-out at the desired minimum value of illumination, and the cell excitation voltage (controlled by K_2) is adjusted to give relay pull-up with the desired maximum value of illumination, if the control circuit is to work between definite limits of light values. Only the grid bias control (K_1) is needed in circuits where light is completely cut off to secure the control operation. Here, either the light beam intensity or the relay contacts can be adjusted to vary the value of illumination which actuates the relay.

► If the load is connected to terminals C and H in Fig. 17B, a reduction or interruption of the light will open the load circuit; if it is connected to terminals C and L, light reduction or cut-off will connect the load to its supply. The circuit to use depends on whether the load circuit is to be turned on or turned off when the light is reduced or cut off. In both cases the relay armature is pulled up as illumination on the cell increases, so this is still a forward circuit, even though a reversed action is obtained.

Reverse Circuit. When the control unit is to be in operation for long periods of time, and the cell is illuminated the greater part of the time, the amplifier tube is passing maximum current most of the time and its life is consequently shortened. A control circuit can be designed in which illumination on the light-sensitive cell produces a low plate current, so that a reduction in light causes the plate current to increase and actuate the relay. This *reverse circuit*, as it is called (where the relay closes when light is *decreased*), gives longer amplifier tube life and consequently less attention need be given the unit. Such a circuit using a photoemissive cell, is shown in Fig. 18; a photoconductive cell can be used also in this circuit.

The variable arm of potentiometer K_1 in Fig. 18 is adjusted so the relay drops out when maximum light is on the cell. The photocell current passing through the 3-megohm grid leak places a high negative bias on the amplifier tube. (The a.c. supply for the photocell is out of phase with that for the tube plate so *negative* pulses are applied to the grid at the time the plate is positive.) This bias is varied by the potentiometer to get the desired minimum value of plate

current. When the light is reduced or cut off, little or no cell current flows through the grid leak. The grid bias becomes practically zero, raising the plate current and pulling up the relay armature. If the load circuit is now connected to H and C, light cut-off connects the load to its supply; if the L and C terminals are used, light cut-off disconnects the load from its supply.

► You can easily tell whether a vacuum tube amplifier control circuit is of the forward or reverse type. In a *forward* circuit the photoelectric cell connects between the *grid* and a point more *positive* than the cathode; in a *reverse* circuit the cell connects between the grid and a point more *negative* than the cathode. Figs. 17A and 17B are forward circuits; Fig. 18 is a reverse circuit.

► The circuits used in Fig. 17 employ low-drain battery type tubes (such as the 30 1G4, etc.) even on a.c. The resulting low-power requirements and the absence of a power transformer make for an economical, light-weight and small unit. However, the use of a power transformer, as in Fig. 18, is desirable as a wider variety of voltages is available, and the transformer isolates the unit from the power line. Tubes such as the 27, 56, 6C5, 6J5, etc., can be used. Incidentally, the circuit in Fig. 18 can be made either the forward or the reverse type by using separate windings on the power transformer and by making the proper polarity connections.

IMPULSE CONTROL CIRCUITS

The principal objection to circuits of the forward and reverse types using *photoconductive cells* is that they are rather insensitive to small changes in illumination. Where simple, rapid off-on light conditions

exist, this objection may be eliminated by employing a circuit which utilizes the charge and discharge ability of a condenser.

A simple *impulse* or so-called *trigger* circuit, using a selenium (photoconductive cell is shown in Fig. 19. A photoemissive cell can be used as well, provided its anode is connected to the potentiometer arm. The unique feature of this circuit is that the grid of the amplifying tube is blocked by a condenser, so that there is no d.c. path back to the cathode. When the cell is illuminated with *any* steady

by some of the electrons in the plate current, and retains them (since they have no place to go). Eventually, this process will build up a negative charge on the floating grid, making its potential about zero with respect to the cathode. Once this happens, very few more electrons strike the grid, because they are repelled by the electrons already on it. The floating grid therefore stays at about cathode potential once it has reached it.

Since point *A* is considerably above cathode potential, and the grid is at cathode potential, a potential dif-

ference (voltage) exists across the grid condenser. This immediately makes the grid (which is connected to the negative end of the condenser) considerably negative with respect to the potential of the cathode, for the positive end of the condenser is now at about cathode potential. Plate current therefore decreases considerably, dropping out the relay. The charge on the condenser gradually leaks off, and the grid "floats" again: plate current then rises, and the relay picks up. When light comes on again, the condenser recharges, and the circuit returns to its initial condition.

An increase in the light on the cell will have no effect on the relay, since it will cause no change in the tube plate current. The only effect the light increase has is that it increases the cell current, and so raises point *A* higher above the cathode in potential. This, in turn, raises the voltage across the condenser, which means that the "trigger" action of the circuit will be stronger (the negative bias of the grid will be greater) when light is cut off. We can produce this stronger trigger action by moving the potentiometer arm nearer the plus

end: doing so increases the voltage across the cell, increasing the current through it and producing the same effect as an increase in light.

A gradual decrease in the light on the cell will not cause this trigger action, because the charge on the condenser will have time to leak off while the potential of point *A* is going down, and no negative bias will be placed on the grid. To sum up: Our trigger circuit works only if the light on the cell is cut off quickly. An increase in light at any speed or a slow decrease, will not affect the plate current of the tube, and the relay will remain in its pull-up position. The relay always returns to its pull-up position shortly after it drops out, even if the cell is not illuminated again.

► A more practical impulse circuit which insures long cell and tube life and strong, positive trigger action is shown in the circuit of Fig. 20. As d.c. is supplied by the rectifier, the grid condenser may have a large capacity. With normal light on the cell the 5,000-ohm cathode variable resistor is adjusted to give a negative bias to the grid, so the relay drops out.

With normal light the cell resistance is low, the voltage drop across the cell is consequently low, and the .25 mfd. condenser receives only a low charge. When the light is cut off the cell resistance rises, there is a larger voltage drop across the cell, the + terminal of the condenser becomes more positive, and electrons flow up through the 2-megohm grid leak to make the - terminal of the condenser correspondingly more negative. These electrons flowing through the grid leak produce in it a voltage drop which reduces the negative bias to zero or even swings the grid positive, and plate current rises, actuating the relay.

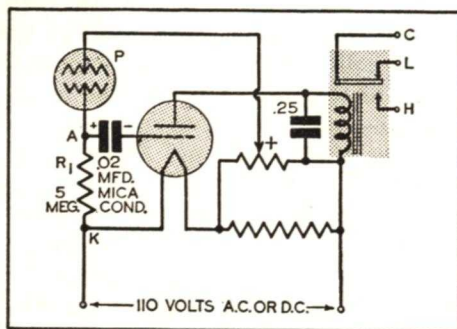

FIG. 19. One form of the impulse circuit, using a selenium cell. The relay, normally closed, drops out when illumination on the cell is cut off suddenly. The relay remains pulled up for all constant values of illumination, and pulls up by itself at a definite time after each interruption of light.

light value, the plate current is a definite value which is fixed by the potential of the floating grid.

The impulse circuit operates in this manner: Assume that the cell is illuminated, current therefore flows through it, making point *A* positive with respect to the cathode *K*. The grid in this tube, under these conditions, is what is known as a "floating" or "free" grid, because no source of voltage is connected directly to it. A floating grid always has a zero, or slightly negative, potential with respect to the cathode. The reason for this is that a floating grid is struck

ference (voltage) exists across the grid condenser. This makes the condenser charge up with the polarity shown in Fig. 19. As long as the illumination on the cell stays constant, this condenser voltage has no effect on the tube plate current. The grid stays at about zero potential, and a rather high plate current flows.

However, a marked effect is produced if the light on the cell is cut off quickly. The cell current then drops rapidly bringing point *A* down almost to cathode potential at once. The charge on the condenser cannot disappear quickly, so the voltage on

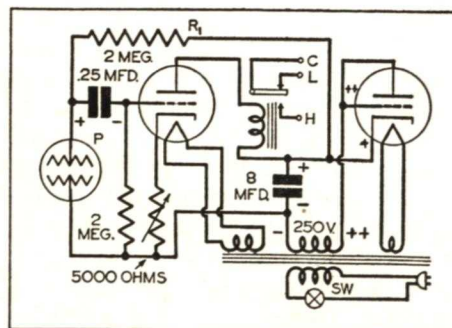

FIG. 20. Another form of impulse circuit, which uses an extra tube to secure d.c. operating voltages. Here the relay pulls up only when light on the cell is suddenly interrupted, and drops out automatically in a definite time interval. Current flows through the tube circuits only during the half of each cycle for which polarity is as indicated.

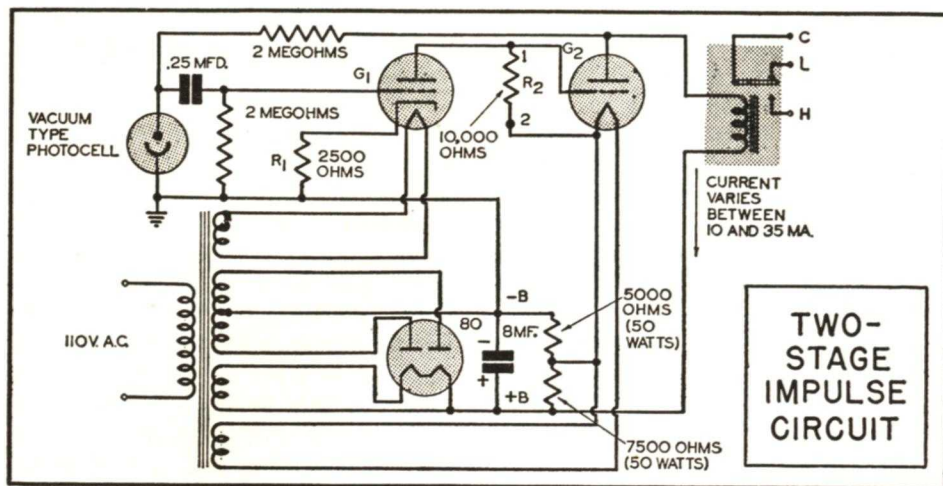

FIG. 21. This diagram shows a two-stage amplifier in an impulse circuit.

When the condenser becomes charged fully (the time required depends on the time constant of the charging circuit) the grid leak current reduces to zero, restoring the normal high negative bias, and the relay drops out. When the cell light comes on again the cell resistance drops, and the fully charged condenser partly discharges through the C bias circuit, driving the grid more negative but, as the relay has already dropped out, no further relay action takes place.

In any of these impulse circuits, increases in resistance of the selenium cell with age and use can be offset by increasing the ohmic value of the grid leak resistor.

Two or More Amplifier Stages. Where the change in light is small, sufficient change in current for relay operation can be obtained by adding a second vacuum tube amplifier. With normal light change, the use of a second amplifying stage permits the direct use of a heavy duty relay. As the variation in light is generally not a cyclic change, but is irregular in its occurrence, direct coupled amplifiers are needed. Impulses or slow cur-

rent changes thus are relayed through the amplifying circuits.

A typical two-stage direct-coupled photocell control circuit is given in Fig. 21. A photoemissive cell is shown, but a photoconductive cell may be used just as well. The circuit is shown operating a heavy-duty relay. If small light changes are used for control, the power tube is replaced with a high- μ triode voltage amplifier tube which feeds into a sensitive relay, and the operating voltages are adjusted for the new tube. Although an impulse or trigger type input circuit is shown, a forward or reverse photocell connection can be used with good results. A gas cell can be used by lowering the excitation voltage; a tap on the voltage supply divider resistance will give the required low voltage.

This circuit works in the following manner. Grid G_1 is biased negatively by resistor R_1 ; grid G_2 is biased negatively by the plate voltage drop in resistor R_2 (terminal 1 is nearer ground or $B-$ potential than is terminal 2). With normal light on the photocell, the plate current of the second tube is large enough to keep the relay

pulled up. When the light to the photocell is cut off, grid G_1 becomes more positive, increasing the plate current of the 27 tube (this impulse circuit is practically the same as that in Fig. 20). This plate current increase causes the voltage drop across resistor R_2 to increase, driving the grid of the second tube more negative. The plate current of the second tube drops, releasing the armature of the relay. As the power tube plate current will drop from about 35 ma. to 10 ma., a heavy-duty relay may be used. A more sensitive circuit can be designed by using a screen grid tube in place of the triode in the first stage.

LIGHT DIFFERENTIAL CIRCUITS

Quite often a circuit is desired which will respond to a difference in light from two light sources. Color matching of liquids (such as dyes) is

in the two beams caused by their passing through the solutions will actuate a meter or start some control operation.

A typical light differential circuit is shown in Fig. 22, where the light of a single lamp is split by two lenses, making two light beams. Each beam is reflected from a mirror, one beam being directed through a glass container holding the standard liquid, the other beam passing through the glass container in which is the liquid whose color or density is being compared. The beam emerging from each container is viewed by a photoelectric cell, which can be either of the emissive or conductive type.

With both containers removed, the arm of potentiometer K is adjusted until meter M reads mid-scale. When the standard and sample products are introduced into the light paths, any difference in the light transmitted

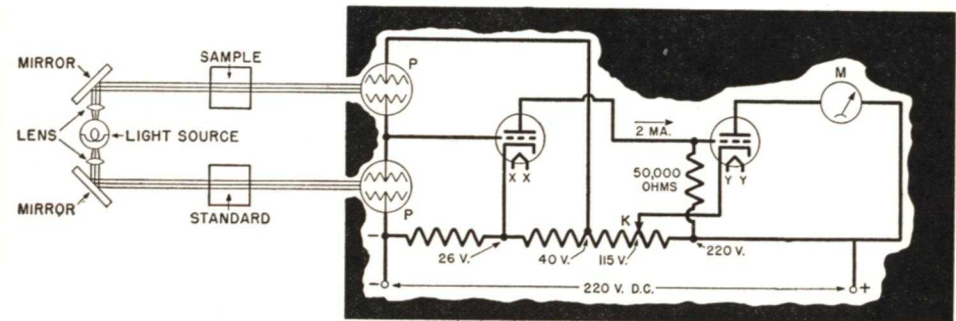

FIG. 22. A light differential circuit.

a typical case. In color matching, two beams of light, each of the same color content and intensity, are used. One beam is sent through a standard solution, the other through a sample of the solution being compared with the standard; then both beams are allowed to fall on photocells connected in a control circuit. This circuit is so arranged that any difference

to the cells shows up as a deviation of the meter from mid-scale. A darker sample causes deflection in one direction, while a lighter sample causes a deflection in the opposite direction. A relay is used sometimes in place of the meter to give a desired control operation when the two solutions differ in characteristics by a specific amount.

Gas Tubes for Direct Power Relay Actuation

A heavy-duty or power relay can be operated directly from a single amplifier tube circuit without using any sensitive relays, provided that the amplifier tube is of the gas or vapor type.

When triode amplifier tubes have gas in their envelopes, as in the case of Thyatron tubes, they are no longer suitable for linear amplification, but have properties which are valuable for electronic control circuits. The action of such a tube is briefly this: When the tube is given a definite plate voltage and the grid bias is gradually varied from zero upward to a certain positive value, breakdown occurs and a very large current suddenly starts to flow through the tube. Now, no matter how the grid voltage is varied, the grid has no further control over the plate current. Only the plate voltage determines the amount of plate current, and this voltage must be reduced to about 20 volts before the current stops flowing. Once the plate current is stopped, the anode voltage can be raised to its original value and current will not again flow through the tube until the grid voltage is raised to the "striking" or "firing" potential. The higher the negative grid bias, the higher the plate voltage required before current flows. Likewise if the C bias is reduced or made positive, the required plate voltage will be reduced.

Thus, the tube either passes full plate current or no plate current—there is no in-between value. The sole purpose of the grid voltage is to determine the point at which plate current starts to flow for that particular plate voltage. Once started, cur-

rent can be stopped *only by reducing the plate voltage* below the 20-volt extinction value.

As the removal of plate voltage is necessary to restore the original conditions, some form of interrupter must be used if the supply is d.c. However, the tube is ideal for an a.c. supply, as here the anode voltage must drop to zero during the half-cycle when the plate is negative. Hence, the grid can resume control every half-cycle, if its voltage has fallen below the striking potential.

HOT CATHODE TYPES

Gas triodes and pentodes are designed to have an oxide cathode of large surface so large quantities of electrons can be emitted. (Gas pentodes work exactly like triodes except that the screen grid protects the cathode and reduces the grid current.) The anode voltage is limited to a value which gives a safe current: If this current is exceeded, the cathode emitting surface is bombarded by positive ions and destroyed. Although mercury vapor is used in certain tubes which operate on high voltages and deliver high plate currents, argon, helium, and neon gases are preferred for low voltage and low current tubes; these gases result in tubes which are fairly independent of temperature. Gas tubes are called *Thyatrions* by the General Electric Company (G.E.), and *grid-glow tubes* by the Westinghouse Electric and Manufacturing Company (W.E.&M.). Mercury vapor tubes are made in sizes capable of passing up to hundreds of amperes, but for control purposes $\frac{1}{2}$ ampere

tubes are sufficient to control the heaviest power relays needed.

► Grid current will flow in hot cathode gas tubes even when there is no plate current. It is highly important that this grid current shall not flow directly through the light-sensitive cell; the cell current should supplement the normal grid current which is made to flow through a *grid resistor*.

This tube uses neon gas and has a constant anode-cathode drop of about 22 volts when passing current, which means that the 1,000-ohm resistor must waste the remainder of the source voltage. The .1-megohm and 2-megohm resistors serve to stabilize the circuit. Although the tube characteristics shown are for d.c. voltages and currents, they also represent instantaneous values in the case of a.c. power.

► The curves are used as follows: Assume that the tube is to operate at a plate voltage of 110 volts a.c.; the peak voltage is then 110×1.41 , which equals about 155 volts. Referring to the E_p curve, we find that about +23 volts on the grid will just allow breakdown of the tube at this plate voltage; any grid voltage *below* +23 volts will not ignite the tube, but if the grid potential ever reaches this value, the gas will ionize. The grid current before breakdown is about 100 ma., and after breakdown it is about 300 ma.

Now, let's see how this tube works in the practical gas tube relay circuit shown in Fig. 24A. Although a photoconductive cell of a type which has a low minimum resistance and a large dark-to-light resistance ratio is used here, photoemissive cells can be used also. The connections to the secondary of the transformer are such that when the plate of the KU-610 tube is positive with respect to the cathode (here the filament), the grid is also positive with respect to the cathode. The potentiometer across the 60-volt secondary winding furnishes the grid bias for the tube by varying the potential of the cathode with respect to the grid. With light on the cell, this potentiometer is adjusted so that (on the positive half of the a.c. cycle) the voltage between P and A minus the voltage drop in R_g

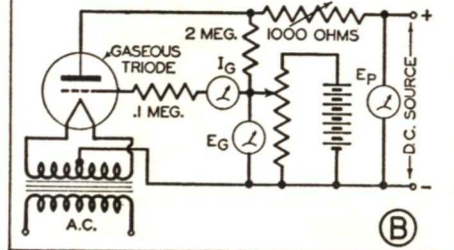
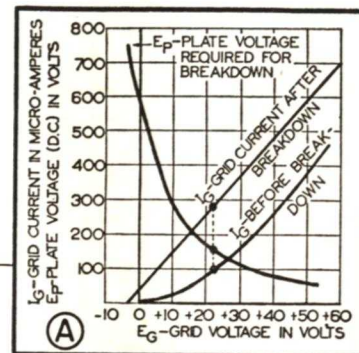

FIG. 23. Characteristic curves of a typical hot-cathode gas filled tube, the Westinghouse type KU-610 grid-glow tube. D.C. starting characteristics for rated anode current are given at A; the test circuit used appears at B.

Figure 23A shows the characteristics of a typical low-power grid-glow triode tube, in this case the W.E.&M type KU-610, which has a maximum rated plate current of $\frac{3}{4}$ ampere. The circuit used to obtain these characteristics is shown in Fig. 23B. The 1,000-ohm resistor prevents the tube from acting as a short circuit across the load when breakdown occurs and the tube passes current. This resistor is adjusted to give rated plate current.

control action occurs. This cold cathode glow tube has many electronic control applications.

For a light-sensitive control, vacuum type photoemissive cells are best, as they have large dark resistances (as much as 5,000 megohms), and will operate safely on high excitation voltages (500 volts is a common value for small cells). In one practical circuit a photoemissive cell is connected between the anode and the grid, and a 0-50 mmfd. variable condenser is connected between the grid and the cathode terminals. The condenser is adjusted so the grid-glow tube does not ignite when the cell is dark. Illuminating the cell swings the grid more positive and causes the relay to pull up. When the cell light is cut off, the relay drops out.

► Photoemissive type cells also can be connected between the grid and the cathode. With this connection,

the variable condenser is placed between the anode and the grid. The condenser is adjusted so the grid-glow tube does not ignite when the cell is illuminated. Now, the tube will break down and pass current, causing the relay to pull up, only when the cell is darkened.

The anode of the photocell should be connected to the anode of the gas tube when the cell is placed between *A* and *G*. The cell anode should be connected to the grid of the gas tube when the cell is wired to *G* and *K*.

► A light-sensitive control using a cold cathode gas tube has the advantage that no power is used in the control circuit when the control circuit is idle, yet heavy-duty relays can be actuated directly. Note that the power used to feed the filament of a hot cathode gas tube is eliminated. Furthermore, the cold cathode tube is extremely sensitive.

THE N. R. I. COURSE PREPARES YOU TO BECOME A
RADIOTRICIAN & TELETRICIAN
(REGISTERED U.S. PATENT OFFICE) (REGISTERED U.S. PATENT OFFICE)



DANGERS OF CRITICISM

If you can't say something good about a person, keep silent. Even when a person asks you outright to criticize, be careful. People often fish for compliments and praise in this indirect way, and criticism is definitely NOT what they want. Be frank only when you're absolutely sure that your technical or personal opinion is really wanted.

There's some good in everything, if we'll only look for it. Praising the good, no matter how little it be, will make you a thousand times more popular with people than criticizing even the most serious and glaring faults of others.

A multi-millionaire executive used these words to praise a Pullman porter, "*I wish I could do my job as well as you do yours!*" A thoughtful business man brightened the entire day for an overworked postal clerk during the Christmas rush by commenting justifiably and sincerely, "*I wish I had hair like yours!*" There are even sincere ways to praise an old radio set: "*It was one of the finest sets made in that period,*" or "*That highboy cabinet is certainly a fine piece of furniture.*"

J.E. Smith