

**LIGHT-SENSITIVE CELLS  
FOR CONTROL CIRCUITS**

25FR-3



**NATIONAL RADIO INSTITUTE**

**WASHINGTON, D. C.**

**ESTABLISHED 1914**



# Study Schedule No. 25

For each study step, read the assigned pages first at your usual speed. Reread slowly one or more times. Finish with one quick reading to fix the important facts firmly in your mind, then answer the Lesson Questions for that step. Study each other step in this same way.

- 1. The Electric Eye ..... Pages 1-7  
Here you learn about the equipment which makes possible almost magical feats in electronics. The apparatus used, the fundamentals of light and illumination, and the types of photoelectric cells are all described. Answer Lesson Questions 1, 2 and 3.
- 2. Photoemissive Cells ..... Pages 8-14  
There are two types of these cells—the vacuum and the gas-filled types. The small amount of gas in the latter type changes the characteristics greatly. Answer Lesson Questions 4 and 5.
- 3. Photoconductive Cells ..... Pages 14-18  
The photoconductive cell operates as a variable resistor, the resistance changing with light changes. Selenium is used so commonly in these cells that they are called selenium cells, although other cell types, having different characteristics, also use selenium.
- 4. Photovoltaic Cells ..... Pages 18-24  
This cell generates its own voltage, so does not require a power source for its operation. This is very important and leads to many applications of these cells. They are used particularly in exposure meters and light meters. Answer Lesson Questions 6, 7 and 8.
- 5. Electron-Multiplier Cells ..... Pages 24-28  
The extremely high sensitivity of these cells makes them very useful where small light values are encountered. They do require a high-voltage power supply, but this is outweighed in many applications. Answer Lesson Questions 9 and 10.
- 6. Mail your Answers for this Lesson to N.R.I. for Grading.
- 7. Photoelectric Control Circuits with Relays . . Reference Text 25X  
Here's a fascinating subject which is becoming of increasingly greater importance as the industrial world turns to electronics for its automatic controls. Read it once, to familiarize yourself with the contents of the book. You will then know where to find this information when you actually need it. If you're doing electronic work now or are deeply interested in it, however, you'll want to study this book just as thoroughly as a regular lesson.
- 8. Start Studying the Next Lesson.

COPYRIGHT 1947 BY NATIONAL ELECTRONICS INSTITUTE, WASHINGTON, D. C.

(An Affiliate of the National Radio Institute)

FM8M1249

1950 Edition

Printed in U.S.A.

## LIGHT-SENSITIVE CELLS FOR CONTROL CIRCUITS

### The Electric Eye

**U**NDoubtedly you have read about the magic *electric eye*, a seemingly mysterious device which causes doors to open as you walk toward them, turns on roadside signs in the country as an automobile approaches, sounds alarms when anyone walks over a forbidden area, prevents dangerous machines such as punch presses from operating while the hands of the worker are in the way, and does thousands of other equally amazing and practical feats. In this lesson you will learn about the many different types of electric eyes, which are called *photoelectric* or *light-sensitive cells* by technical men. You will learn how each type of cell is constructed, how it functions, and how it can be made to replace man's eyes.

► Thousands of light-sensitive cells are in use today in every corner of the world, responding to beams of light which may be perfectly invisible to the human eye, detecting every change in illumination from the sun or from other sources of light; these cells change their *electrical characteristics* with variations in the light which they "see". These light-sensitive cells start and stop heavy machinery, count objects moving past at a mile-a-minute speed, guard against fire, smoke, water, and burglars, and even "read" books for blind persons. Cigars, beans, eggs, fruit, and other products are being graded as to color or shade by light-sensitive cells, faster and more

accurately than by the human eye.

Although the field of photoelectricity is not new, its development into commercial practicality has taken place within the last few years. Scientists have known for more than one hundred years that certain electrical effects could be obtained by exposing chemical elements and com-

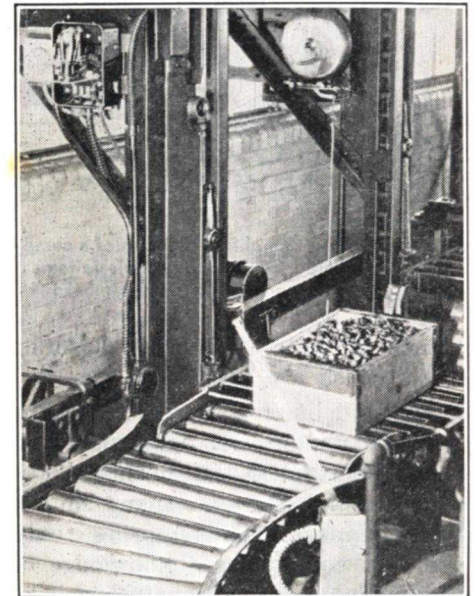

Courtesy General Electric Co.

A typical industrial use of photoelectric equipment. When the light beam is interrupted by a box, a number of actions are possible. The unit may actuate a counter; may sound an alarm; or may operate automatic machinery such as an elevator. It may also separate cases according to size or shape by operating an assorting apparatus. Thus, the same equipment may be used for many purposes, depending on what it is used to control.



pounds to light, but the lack of suitable apparatus to make use of this electrical effect, and the poor sensitivity of the light-sensitive cells then available prevented the commercial use of this photoelectric action.

Recent developments in the field of television and electronics resulted in a great demand for photoelectric devices, and today the electric eye is looked upon as a dependable and invaluable device for industrial and commercial applications. As men in industry and business realize the value of electronic control, more of these devices will find their way into everyday use. Only the imagination of man

stallation, so you can understand better the important part played by the light-sensitive devices which you will study. The six important basic parts of a complete photoelectric control installation are:

**1. The Light Source.** The light which is directed upon the electric eye may be the natural light from the sun or artificial light from an incandescent lamp, gas flame, arc light, etc.

**2. Light Beam Apparatus.** On some photoelectric installations, it is necessary to concentrate the light into a narrow beam in order to make it travel over a definite path before

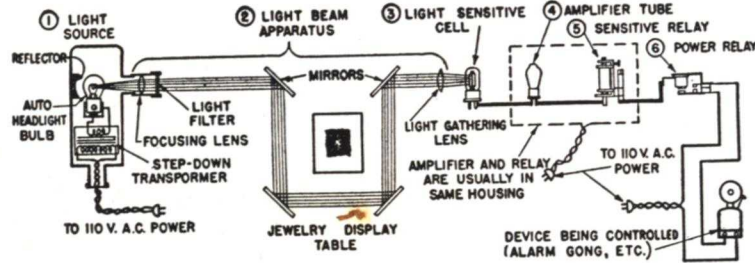

FIG. 1. Simplified diagram of a complete photoelectric installation such as might be used to protect valuable jewelry on a display table. The infra-red light filter on the light source makes the light beam practically invisible.

stands in the way of accomplishing deeds which are best called *magic*.

► As a sideline for the radio man, the field of photoelectric control offers great opportunities, for, in this branch of electronics, there are many simple, basic applications requiring only standard equipment, a knowledge of the fundamentals of photoelectricity and radio circuits, plus mechanical ingenuity and common sense.

### A COMPLETE PHOTOELECTRIC INSTALLATION

Before taking up the different types of light-sensitive cells, we will describe briefly a complete photoelectric in-

stallation, so you can understand better the important part played by the light-sensitive devices which you will study. The six important basic parts of a complete photoelectric control installation are:

reaching the light-sensitive cell; lenses and curved mirrors are used at the light source to accomplish this. Again, it may be necessary to change the direction of the beam of light with a mirror, or to make the light beam invisible to the human eye by using filters which absorb the visible light rays. Where insufficient light reaches the light-sensitive cell, it may be necessary to use a collecting lens which gathers light and concentrates it upon the relatively small area of the light-sensitive cell.

**3. The Photoelectric Cell.** The electric eye or light-sensitive cell changes its electrical characteristics in

response to changes in illumination.

**4. The Photoelectric Amplifier.** With certain types of light-sensitive cells, it is necessary to build up the strength of the variations in current or voltage from the light-sensitive cell by means of a vacuum tube amplifier, which may contain one or more ordinary radio amplifier tubes or gaseous tubes.

**5. Sensitive Relays.** The photoelectric cell or amplifier output is used to *control* some circuit which may be power operated, so a relay is used to close (or open) the power circuits. When the relay is connected directly to the output of the light-sensitive cell, a super-sensitive relay is needed; when connected into the plate circuit of the amplifier tube, an ordinary sensitive relay is satisfactory. Relays which operate on currents of less than 250 microamperes are classed as *super-sensitive*; those which require from .5 to 100 milliamperes (at low power) are classed as *sensitive* relays.

**6. Heavy-Duty Relays.** An additional relay, used after the sensitive relay, is necessary in installations where the preceding relay is not capable of handling the current required by the device being controlled. In some very large installations two or even more power relays, one operating the other, are required. Relays which require more than 100 milliamperes are considered the *heavy-duty* type.

► The simplified diagram in Fig. 1 gives you the relations between the various parts in a typical photoelectric installation (the alarm gong sounds if the light beam is intercepted at any point along its path). Fig. 2 shows a typical commercial photoelectric unit having several of the basic parts mounted in one housing.

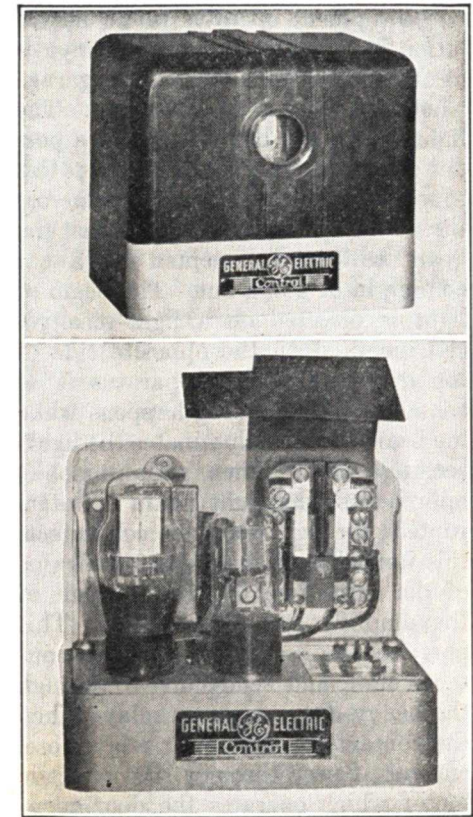

Courtesy General Electric Co.

FIG. 2. A typical commercial photoelectric assembly. The upper picture is one of the housing, while the lower gives a view of the interior, showing an amplifier tube, the photocell, and a relay. This unit may be used in many ways, requiring only a light source to form a complete installation.

By properly choosing circuits and relays, you can make a change in cell illumination produce any desired control operation, choose the degree of light intensity at which the relays will operate, and speed up or slow down the action of your controls as much as you desire. The only actual limitations to a photoelectric control system are the sensitivity of the light-sensitive cell with its associated apparatus and the ingenuity of the control engineer.

► An example of how this photoelec-



tric equipment operates is the installation in which a photoelectric eye is used to open the doors of a garage when a car enters the driveway. The light source can be mounted on a post on one side of the driveway; this source throws a beam of light across the driveway at such a height that the beam will be intercepted by a car coming in or going out. The beam of light is directed on a light-sensitive cell mounted on the opposite side of the driveway. The apparatus is so connected that nothing happens while the beam of light illuminates the light-sensitive cell. When an automobile approaches, the light beam is interrupted; the light-sensitive cell detects this immediately and causes the value of the current in the plate circuit of the amplifier tube to change. This operates the sensitive relay; its contacts close and send current through the heavy-duty or power relay. When the contacts of the power relay close, current flows through the electric motor which operates the door-opening mechanism. All this happens so quickly that the garage doors are completely open by the time the car reaches them.

### WHAT IS LIGHT?

The importance of *light* in any

photoelectric installation should be quite obvious from what has been said up to this time. Let us, therefore, start your study of light-sensitive cells by first learning just what light is and how it is measured.

The greatest source of light is the sun; it sends out waves which are identical with those which we use in radio communication, except that they are a great deal shorter in wavelength. Light waves which can be seen by the human eye vary in length from 40- to 70-millionths of a centimeter. The wavelength of light can, for convenience, be expressed in millimicrons, units of length equal to one-thousandth of one-millionth of a meter or one ten-millionth of a centimeter. The human eye, therefore, responds to a light between 400 and 700 millimicrons. Radio waves, which range from .01 to 25,000 meters in length, are more than one million times as long as visible light waves.

The wavelength determines the color of the light; a combination of wavelength (colors) produces the sensation of white light. The human eye does not respond to all colors equally; it is most sensitive to yellow and green. Study Fig. 3 carefully, noting how the human eye responds to the different colors in the visible spectrum.

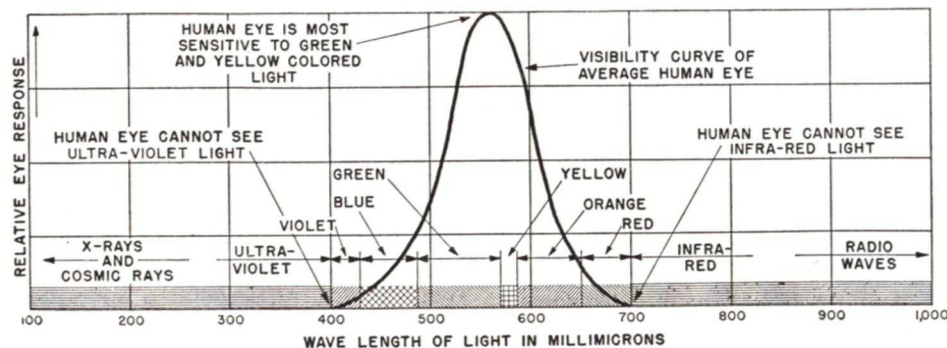

FIG. 3. The relative sensitivity of the average human eye to light of various colors (various wavelengths) is given by this curve.

The electric eye, in addition to "seeing" those frequencies of light which can be detected by the human eye, will respond also to ultra-violet light and infra-red light, both of which are invisible to the human eye. It is this characteristic of the electric eye which makes it possible to use invisible light beams to control machinery or to operate burglar alarms.

Light-sensitive cells respond to various types of artificial light as well as to natural light. The ordinary incandescent electric lamp is the most common artificial source of light for photoelectric equipment. Its filament, a very fine wire of high resistance, is heated by a current of electricity until it becomes incandescent and gives off light. Electric lamps designed for automobile headlights are ideal for photoelectric work because the source of light is concentrated into a very small space, approximating a point source of light. The smaller the source of light, the easier it is to focus that light into a beam.

Other artificial sources of light include natural gas lights, coal gas lights, the carbon arc lamp, the mercury vapor lamp, gaseous conduction tubes (better known as neon tubes), and fluorescent lamps.

**How Light Is Measured.** As you know, the wax or tallow candle was one of the first artificial sources of light. When new light sources began to take the place of the candle, it was natural that their power should be expressed in terms of the old and familiar candle. Eventually a candle made according to certain specifications and burned under certain conditions was selected as the unit of light intensity, and the light given off by this candle was said to have an intensity of *one candlepower*. If an electric bulb was found to be 40 times as

strong as this candle, it was said to have a candlepower rating of 40. The average electric lamp used in the home has an intensity of about one candlepower per watt of power used.

You may have noticed that the strength of the light on a certain object, such as a book, decreases very rapidly as the book is moved away from the source of light. Actually the intensity of the illumination produced by a source of light varies *inversely as the square of the distance* from the source of light. In other words, if the illumination at a point two feet from the source is a certain value, the illumination at a point four feet from the source (twice as far away) will be one-fourth of that at the first point.

The practical unit of illumination is the *foot-candle*. This is the *intensity of the light on a surface* which is directly facing, and one foot away from, a light source which has an intensity of one candlepower. For example, the correct illumination for general reading purposes is about 15 foot-candles; this means that the illumination on the printed page should be equivalent to that which would be produced by 15 standard candles located one foot above the page.

Another unit of illumination, the *lumen*, represents the *amount* of light (or light flux) falling on a surface one square foot in area, every point of which is one foot from a point source of light having a strength of one candlepower. Practically, however, to determine the amount of light (number of lumens) falling on a uniformly-illuminated surface of limited area, you multiply the area of the surface (in square feet) by the intensity of the illumination at the surface (in foot-candles). The answer will be in lumens. To determine the



number of lumens of light emitted by a lamp, multiply the candlepower rating of the lamp by the number 12.6.

The foot-candle is a measure of the intensity of light at a certain point, such as at the face of a light-sensitive cell; the lumen is a measure of the amount of light falling on a given area, such as the sensitive surface of a light-sensitive cell. Light intensity at the cell (in foot-candles) multiplied by effective area of the cell (in square feet) gives the number of lumens of light on the cell.

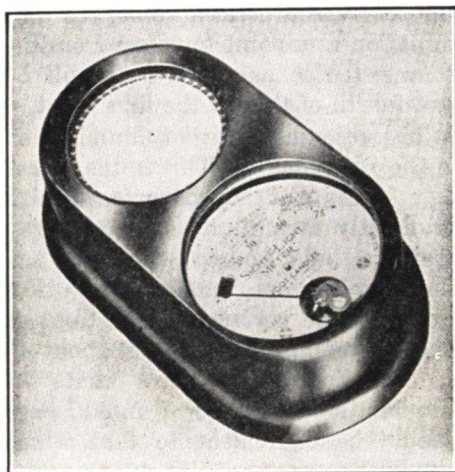

Courtesy Weston Electrical Instrument Corp.

This type of light meter is used to measure the illumination in a home or an office. If the amount of light is too low, corrective measures can be taken and the results checked by the light meter.

Brightness is another factor which must be considered by the photoelectric engineer, as he will often direct a light on a certain surface and use an electric eye to pick up the light reflected from that surface. Brightness can be expressed in *candles per unit area*; this means that brightness is a measure of the ability of an illuminated surface to act as a source of light. For example, a surface has a brightness of 10 candles per square foot when each square foot of this

surface reflects as much light in a given direction as would 10 candles.

**Light Sources.** In most photoelectric applications, it is very desirable to have a definite beam of light directed on the electric eye. Naturally, it is desirable to use as small a light source as possible, in order to economize on power and make a compact unit. Most commercial light sources for photoelectric work use the small but powerful 32-candlepower automobile headlight bulb (the required low voltage is obtained from a step-down transformer which is connected to a 110-volt a.c. line), concentrating the light into a beam with a lens. Since only that light which falls on the lens is useful in producing the beam, reflectors are generally used back of the bulb to reflect light to the lens. Some light is absorbed at each reflection and at each passage through a lens, so it is usually necessary to make adjustments of the light source and the relay apparatus until satisfactory operation is secured.

#### TYPES OF CELLS

Although photoelectric or light-sensitive cells of various types are being manufactured today by many different firms, all of these can be divided into four basic classes. These four classes of light-sensitive cells are:

**1. Photoemissive Cells.** In these cells, electrons are emitted from the cathode of the cell by the action of light, and are collected by an anode which is at a positive potential. Photoemissive cells are better known as *photocells*; some technicians prefer to call them phototubes, since they are always built into glass envelopes as are glass type radio tubes. In many technical books and articles you will find all types of light-sensitive cells referred to as photocells, but you can

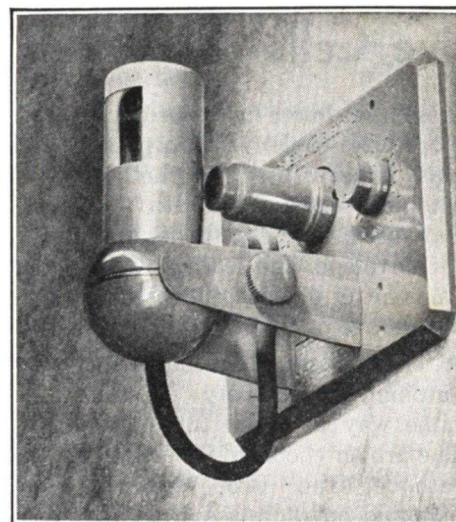

Courtesy General Electric Co.

A wall-mounted photocell assembly. This type is particularly designed to turn on lights in a room when the illumination falls to an unsatisfactory level, and to turn off lights when the level rises above the preset value. The two controls are used to set these upper and lower limits.

generally determine which type of cell is meant from the nature of the discussion. Remember that when we speak of photocells in this book we are referring specifically to *photoemissive cells*.

**2. Photoconductive Cells.** In these cells the resistance (or conductivity) of a material changes under the action of light. Selenium is the resistance material most commonly used in these cells. You will find that photoconductive cells which use selenium are often referred to as *selenium cells*.

**3. Photovoltaic Cells.** These cells develop their own voltage under the action of light. They are referred to often as photoelectric cells, but photovoltaic cells or self-generating cells are

the terms which will be used in this Course. The term photoelectric cell, as used in this Course, will refer to light-sensitive cells in general, regardless of their type.

#### 4. Electron-Multiplier Cells.

These are really a kind of photoemissive cell, but are so different from the usual photocell that we should treat them as a separate type. An electron-multiplier cell has one cathode and a number of anodes, each of which is maintained at a different positive potential. Through a series of actions, which we will describe later in this lesson, this cell is able to produce many more electrons than are driven out of the cathode by photoelectric action. In this Course, we shall refer to electron-multiplier cells simply as *multiplier cells*.

► Each light-sensitive cell has its own characteristics, and naturally transfers these characteristics to the associated photoelectric apparatus. Some cells are more dependable than others; some require external sources of voltage which may fail; some cells have a comparatively short life—all these factors must be taken into consideration where failure of the photoelectric control would in any way endanger human life or damage valuable equipment. We are going to devote the remainder of this lesson to detailed descriptions of each type of cell, telling how they are constructed, how they operate, and basically, how they are used. When you have finished, you will have all the basic information you need to understand the operation of modern photoelectric equipment.



# Photoemissive Cells

The photoemissive cell can be compared to a diode or two-element tube, for both contain two electrodes mounted in a glass envelope. In the radio tube, the electrons which make up the current through the tube are produced by heating the cathode (filament); but, in the photoemissive cell, the light rays activate the sensitized surface of the cathode and cause electrons to be emitted. The other electrode, called the anode, attracts the emitted electrons, as it is positively charged with respect to the cathode. *The emission varies with the amount of light*; the more light there is shining on the cell, the greater is the emission. Current will flow through the tube; the amount depending on the emission and the applied voltage. The tube acts like a variable resistance, the resistance value following the light variations.

The construction of a typical photocell is shown in Fig. 4. Here the cathode is a semicircular cylinder of metal (usually oxidized silver) supported inside the glass envelope by stiff wire leads made of nickel. The anode is simply a nickel rod or wire placed in the axis of this cathode cylinder. The anode is untreated, but on that surface of the cathode which faces the anode is a thin film made up of caesium oxide, sodium, potassium, or lithium. For practical purposes, just consider the cathode film as simply a layer of light-sensitive chemical compound.

Soda-lime glass is used as the envelope for most of the inexpensive photocells made today, since it is cheap and easy to form into the desired shape. Higher-priced cells use either pyrex glass or fused quartz, as

these have lower light losses and allow more ultra-violet rays to pass. Lead glass is never used for photocells. It combines chemically with the materials used on the cathode, discoloring the envelope, and lead glass is a poor transmitter of light (it absorbs a high percentage of the rays).

► The modern photocell is made by automatic machinery in much the same way as radio tubes are made. The proper chemical is sprayed on the cathode, the two electrodes are mounted on the glass stem, and then

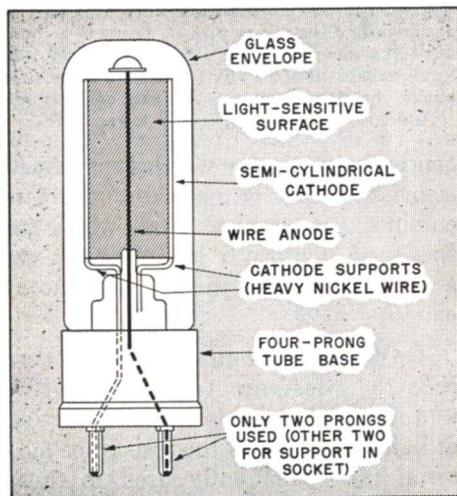

FIG. 4. The connections and parts of a photoemissive cell.

this stem is sealed to the glass envelope. The gas is evacuated by vacuum pumps, and the tube is given a special treatment in a high-frequency electrical furnace to complete the processing of the coating on the cathode.

Notice that the anode in a photocell is the *smallest* electrode; this is necessary so that the anode will not cast too large a shadow on the cathode and reduce the efficiency of the cell. In

regular radio tubes the opposite holds true; here the plate or anode is the *largest* electrode.

► Two types of photocells are in common use, differing only in that one contains a gas while the other has a "hard" or high vacuum. Gas cells give an increased current output for a given amount of light. The sensitivity of a photoemissive cell is controlled by the cathode materials; the introduction of a gas reduces the effect of the space charge and permits greater sensitivity to be attained.

► Since the current passed by the cells is too small to operate even a super-sensitive relay, photoemissive cells are always used with one or more amplifier tubes. A typical circuit which can be used either with gas or vacuum type photocells is given in Fig. 5. The photocell is connected so that the voltages of the B and C batteries will be applied to it through R. (Its current will not operate the relay.) An ordinary radio tube such as the 1H4G (or any triode, provided the proper voltages are applied) serves as amplifier tube; the relay is a sensitive type, with its contacts connected into the power supply leads of the device being controlled.

In this basic circuit the grid of the amplifier tube has a negative bias, and therefore draws no current. The relay resistance (usually somewhere between 1000 and 10,000 ohms) is comparatively low with respect to the circuit resistance, so we can consider the photocell and resistor R to be in series across points A and B of the batteries. When the photocell is dark, (no light on it) there is no emission, so practically no current flows through it and R. Hence, the voltage across R is very low, and the grid of the tube can be considered to have almost the same negative potential as point A.

With a highly negative grid, little or no electron current passes from cathode to plate in the amplifier tube, and the relay armature is not attracted to the relay core.

When light falls on the photocell, its emission rises and more current can flow through R and the photocell, so the voltage across R becomes greater. Electron flow is from A through R,

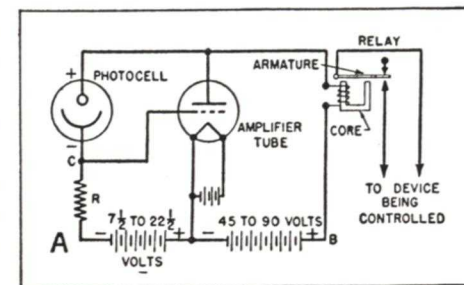

FIG. 5. A basic circuit which can be used with the photoemissive cell.

through the photocell and through the relay to B; point C is therefore more positive than point A. The grid thus becomes more positive than point A when light falls on the photocell. With a lowered negative bias on the grid, plate current flows through the relay, causing the armature to be attracted to the relay core. In a practical circuit the grid bias would be controlled by a potentiometer connected across the grid bias battery, which would allow the circuit to be adjusted for maximum response to the desired changes in light.

It is only necessary to interchange the positions of R and the photocell in this circuit in order to make the relay operate when the cell is darkened (as when some object interrupts a light beam directed on the cell). In this reversed circuit, light on the cell produces a high current, but the voltage across the low cell resistance is small and is "cancelled" by the high grid



bias. Darkening the cell raises its resistance so much that most of the voltage drop across the combination of  $R$  and the cell is developed across the cell. This makes the anode of the cell more positive than it is when the cell is illuminated; thus, the negative bias of the grid is reduced, and the increased flow of plate current closes the relay.

### VACUUM TYPE PHOTOCELLS

In the vacuum photocell the total tube current is made up of electrons that are emitted by the cathode (see Fig. 6). This cell will respond to light variations of almost any frequency, which means that it is ideal for use in the fastest of counting jobs. The capacity between the anode and cathode is the only important limitation on the highest light variation frequency to which this cell will respond.

Just as curves are used to illustrate the characteristics of the vacuum tubes which you have studied, so can curves be used to illustrate photocell characteristics. The stronger the light the greater will be the current flow, but does this relation hold at all times? Is the current affected by the voltage applied to the cell? These are important questions which can be answered easily by making some simple tests.

A standard incandescent electric lamp is used in securing characteristic curves for all types of light-emissive cells, and the voltage applied to it is adjusted to operate the filament at a constant temperature. The illumination on the cell is varied by changing the distance between lamp and cell rather than by varying the light source.

**Current-Illumination Curve.** This important photocell characteristic curve is obtained by applying a fixed

voltage (say 40 volts) to a cell and measuring (with a microammeter) the current passed by the cell at different intensities of illumination. With a vacuum type photocell, the results obtained will give a curve like that in Fig. 7A, which shows that the current output is directly proportional to the amount of light falling on the cell. That is, the cell current doubles when the light flux is doubled.

**Current-Voltage Curve.** If a vacuum type photocell, illuminated by a constant light intensity of about .5 lumen, is connected to a variable source of d.c. voltage, and measurements are made of the current passed

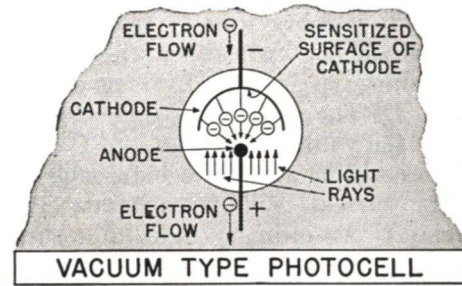

FIG. 6. Here are the details of operation of the vacuum type photocell.

by the cell for each value of voltage, the curve obtained will be like that shown in Fig. 7B. Notice that once the voltage reaches a certain value (above the knee of the curve) the cell current increases very little as the voltage is further increased. At this point, called the *saturation value* of current, practically all of the electrons emitted by the cathode under the action of the fixed light are drawn to the anode. Clearly, then, there is little to be gained by increasing the voltage above this value. A small size vacuum cell can safely withstand up to 500 volts; often such a high value must be applied to the cell because of circuit conditions.

The curve in Fig. 7B can be made to show the relation between the sensitivity of the cell and the cell voltage simply by dividing the current values by the number of lumens of light on the cell. The vertical scale at the right in Fig. 7B is obtained in this way, by dividing each value of current in the scale at the left by .5, which is the number of lumens of light on the cell. You can easily see that a vacuum type cell should be operated at a voltage corresponding to a point *above the knee* of the curve if greatest sensitivity is to be obtained.

**Color Response Curve.** Another very important photocell characteristic is its response to light of different colors (wavelengths). The curve in Fig. 7C gives this information for a typical vacuum type photocell. In general, the color response of a photocell differs considerably from that of the human eye (shown by the dash-dash curve).

These color response curves are important when the job is one of assorting objects by color; filters must frequently be used to correct the response so that the proper selection will occur, or another cell with a more favorable response must be used. Various light-sensitive materials are used on the cathode to get certain desired color characteristics. Quartz must be used for the envelope where a tube is to be highly sensitive to ultra-violet light, since ordinary glass does not transmit ultra-violet rays.

The characteristics shown in Fig. 7C show a peak in the response in the infra-red light region, so this cell is an excellent one to use with invisible light beams in burglar alarms, etc.

### GAS TYPE PHOTOCELLS

The gas type photocell differs from the vacuum type only in that, after

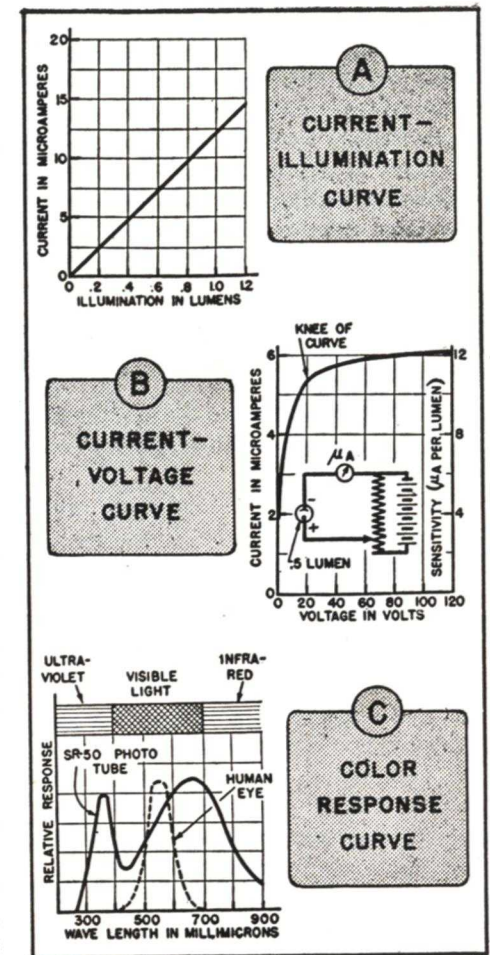

FIG. 7. Typical characteristic curves for vacuum type photoemissive cells. (These curves are for the Westinghouse SR-50 photocell.)

the cell is evacuated, a small quantity of an inert gas (a chemically inactive gas which will not combine with the tube elements) such as argon, helium, or neon is admitted before sealing off the tube. In this gas type cell the electrons emitted by the cathode, traveling at high speed towards the anode, have sufficient force to knock out electrons from gas atoms with which they collide. Thus, they split up the atoms into positive ions and free electrons; this process is known as *ionization*. The electrons resulting



from these collisions are attracted to the anode along with the emitted electrons, and serve to build up the photocell current. The positive ions (atoms from which electrons have been knocked out) move to the space cloud near the cathode, neutralizing the electrons there and allowing more of the electrons from the cathode to find a free path to the anode. If the ionization is made too strong by excessive anode voltage, a glow discharge similar to that in neon sign tubing will be produced. Then the gas ions will bombard the cathode and destroy the tube.

This "ionization by collision" process is shown in Fig. 8. The original tube current can be increased as much as ten times by the ionization of the gas. However, the amount of ionization increases rapidly as the voltage is increased, so the voltage must be kept below a critical value in order to prevent a glow discharge from destroying the tube. With too-high voltages the gas type tube will pass current even when no light is falling on the cathode. The operating voltages vary between 25 and 100 volts for the average gas photoemissive tubes, depending upon their construction. Under no conditions should this voltage be exceeded.

Characteristic curves for a typical gas type photocell are given in Figs.

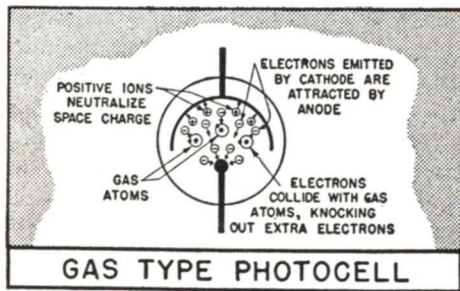

FIG. 8. The gas cell depends upon gas ionization for increased sensitivity.

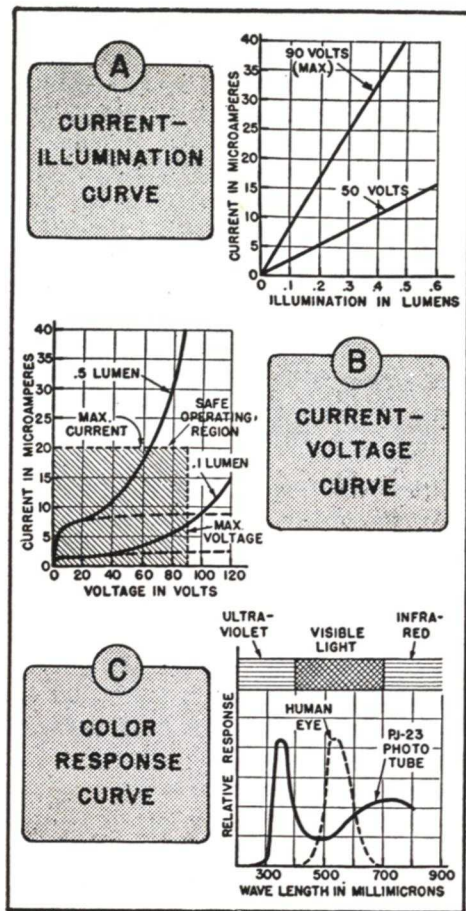

FIG. 9. Compare these gas cell curves with those of the vacuum type in Fig. 7. (These curves are for the General Electric PJ-23, which is typical.)

9A, 9B, and 9C. The current passed by the gas type cell increases practically in direct proportion to the illumination, just as in the vacuum type cell (Fig. 7A).

The curves in Fig. 9B give you a very good idea of the characteristics of a gas type photocell. At voltages below 20 volts this cell behaves almost exactly like a vacuum type cell (Fig. 7B) because, at these low voltages, the emitted electrons do not reach a sufficiently high speed to knock electrons

out of the atoms of gas inside the photocell. At some voltage above about 20 volts (above the knee of the curve) ionization starts, and further increases in voltage give much greater increases in current than are obtained with a vacuum type cell. The dotted lines (Fig. 9B) show how the current would vary at higher voltages if there

the tube to limit current to a safe value in case the illumination is accidentally increased.

**Gas Ratio.** In the gas photocell, the ratio of the current passed at its maximum safe operating voltage, to the current passed just before ionization (and gas amplification) begins, is known as the *gas ratio* of the tube.

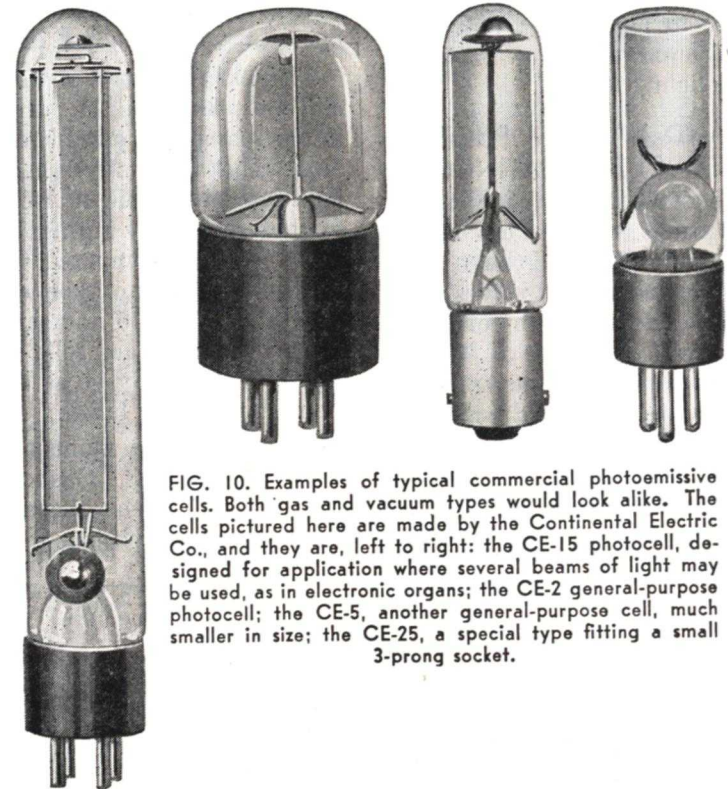

FIG. 10. Examples of typical commercial photoemissive cells. Both gas and vacuum types would look alike. The cells pictured here are made by the Continental Electric Co., and they are, left to right: the CE-15 photocell, designed for application where several beams of light may be used, as in electronic organs; the CE-2 general-purpose photocell; the CE-5, another general-purpose cell, much smaller in size; the CE-25, a special type fitting a small 3-prong socket.

were no gas in the tube.

The voltage and current ratings specified by manufacturers for gas type tubes must be carefully followed if the tube is to be in operation for long periods of time. Voltages slightly higher than rated values shorten tube life considerably. In general, the maximum safe operating voltage of the average gas type photoemissive cell is about 100 volts. It is a good idea to place a resistor in series with

For example, the gas ratio in Fig. 9B is about 7; this value is obtained by dividing the current at 90 volts by the current at 25 volts, the illumination being held constant at a value which limits the current at 90 volts to a safe value. The values of illumination used are generally specified for gas ratios, since the ratio depends somewhat on the illumination (it becomes less as illumination on the cell is decreased).

**Color Sensitivity.** The color



response of a gas type photocell depends upon the kind of glass used for the envelope and upon the nature of the light-sensitive material used on the cathode. The curve in Fig. 9C is therefore not a general response, but is instead the color characteristic associated with the cell used in making this curve and others like it. As you can see, this particular tube has high sensitivity to ultra-violet and infrared, but comparatively low sensitivity to visible light.

### GAS AND VACUUM PHOTO-EMISSIVE CELL RATINGS

Just as radio tubes have certain definite ratings which must not be exceeded, so do photocells have maximum voltage and current values which cannot be exceeded in ordinary practice.

The *maximum anode current* is the maximum value of current which can be safely passed by the tube. For a.c. this is the peak value of current.

The *maximum anode voltage* is the maximum value of voltage which can

safely be applied to the tube. For a.c. this is the peak value of voltage.

The *maximum illumination* is more important in connection with gas type cells than with vacuum type cells. At high values of illumination, the voltage applied to a gas type photocell must be considerably lower than the rated value in order to keep the current down to a safe value (in the safe operating range shown in Fig. 9B).

The *sensitivity* of a photocell is generally expressed as the current passed in microamperes per lumen of light flux. This is usually measured at a light intensity of either .1 or .5 lumen, so that sensitivity ratings of various tubes can be compared. The sensitivity of vacuum type cells varies from about 5 to 35 microamperes per lumen, while for gas cells, rated sensitivity values may be as high as 300 microamperes per lumen.

Fig. 10 shows a number of typical photoemissive cells. Gas and vacuum type photocells look the same, since the gas used is invisible.

## Photoconductive Cells

The photoconductive cell is essentially a resistance whose ohmic value varies with the light falling upon the cell. The stronger the light falling on the cell, the lower becomes the resistance. There is no "emission" of electrons here; the cell is just a resistance which varies with light. When placed in a circuit with a voltage source, the current flow will depend on the voltage and the resistance value at the moment. When dark, the cell resistance is high but it still will pass some current. Hence, there is no "cut-off" of current; it is just varied from a low value to a higher value by the cell

resistance variation.

The photoconductive effect was noticed first by an engineer named Willoughby Smith, who, while stationed in the Azores Islands in 1871, observed that the selenium resistors he was using changed their resistance when exposed to sunlight. Reporting the discovery to a group of scientists, he announced: "By the aid of the telephone I heard a ray of light fall on a bar of metal!"

Photoconductive cells are made almost exclusively from selenium, although certain other compounds, one of which is thallium oxysulfide, show

appreciable photoconductive effects. Many different forms of selenium cells are on the market today.

► The term "cell" is somewhat misleading when used in connection with photoconductive cells and photoemissive cells, as these do not generate their own voltage and are not therefore to be compared to a battery. The word *cell* is, nevertheless, commonly used among technical men for all classes of light-sensitive devices, and is used as such in this lesson. You will be able to tell what is meant by referring to the circuit diagram, because the symbols for light-sensitive cells are quite different from the symbols for batteries.

### SELENIUM CELLS

A selenium cell consists essentially of two electrodes between which is deposited a thin film of selenium. The electrodes, which can be copper, iron, nickel, aluminum, silver, gold, platinum, metal alloys, lead, graphite, or carbon, are mounted on some insulating block such as quartz, glass, clay

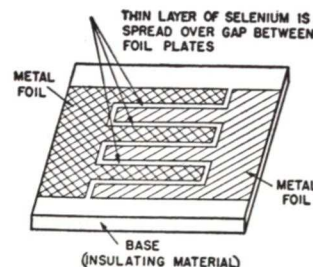

FIG. 11. This sketch shows the basic construction of the selenium cell.

compounds, porcelain, slate, mica, or bakelite.

The construction of a simple selenium cell is pictured in Fig. 11. Two pieces of metal foil are cut out as shown, and cemented to the flat base, after which a thin layer of molten selenium is spread evenly over the foil plates and all gaps between the foil

Sometimes the selenium in powder form is sprinkled over the plates, then heated and spread out, or selenium is heated to its boiling point and the vapors allowed to condense on the plates. In any event, the cell must be annealed by heating carefully until the selenium changes from its pitch black form to the gray crystalline form which is highly sensitive to light, then the cell is cooled slowly.

► Commercial selenium cells are made in a number of different ways. One type of cell has two wires wound over an insulating slab, with a thin layer of selenium deposited between the wires. Each wire serves as a terminal of the finished cell, the resistance between the two wires being determined by the resistance of the selenium layer. A flat piece of slate is sometimes coated with a film of graphite which is polished with a chamois skin, then divided into two interlacing sections with a sharp tool and selenium deposited over the entire surface.

In other types of selenium cells a thin film of platinum, gold, or silver is fused into the surface of a block of glass or quartz. Then, this thin metal film is divided into two sections by a zigzag or comb-like line made with a precision instrument known as a "dividing engine." There may be as many as one hundred lines or scratches per inch on the cell. When the metal film has been divided into two separate electrodes in this manner, a thin layer of selenium is placed over the entire unit, this selenium serving to bridge the gaps between the two electrodes. This method gives a very small separation between the two plates and a long gap covered with selenium.

► The cell whose characteristics are given in Fig. 12 belongs in this last class; it is highly sensitive to changes



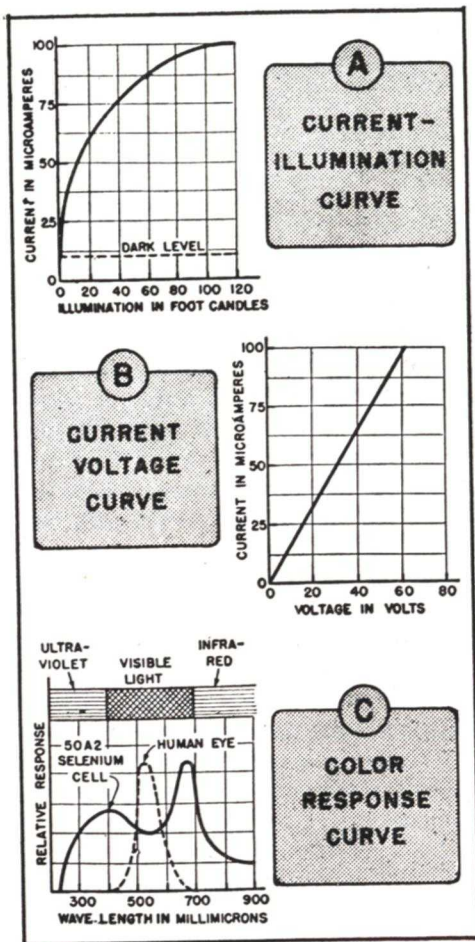

FIG. 12. The Acousto-Lite Laboratories 50A2 selenium cell was used in making these curves.

in illumination but is not recommended for operating voltages higher than 80 volts or light intensities of more than 20 foot-candles. As a precaution against breakdown from excess voltage or excess current, a 1-megohm resistor is usually connected in series with the cell.

By looking first at the Current-Illumination Curve (Fig. 12A), you can see that the current passed increases with illumination, but the effect of the light (the increase in current) is less at the higher values of illumination. Notice that the current

does not drop to zero when the cell is dark (the applied voltage being held constant). Selenium cells have a definite "dark" resistance, so current can drop only to the dark level when light is cut off from the cell. The resistance of this particular cell is about 10 megohms in the dark and about 2 megohms at an illumination of 10 foot-candles, hence it has what is called a dark-to-light resistance ratio of 5.

When illumination is held constant on a selenium cell and the voltage is varied, the current varies exactly as it would for an ordinary fixed resistance. You know that the current passed by a resistor varies directly with the voltage applied; that is why the curve in Fig. 12B is a straight line.

You will find that most selenium cells have a maximum sensitivity to red or infra-red light, with a lower peak (in some instances) in the ultra-violet region (Fig. 12C).

Photoconductive cells are generally used with vacuum tube amplifiers, just as are photoemissive cells, but it is possible to make them with a resistance sufficiently low to permit direct operation of a sensitive relay. A battery must be connected in series with the cell and relay, as photoconductive cells do not generate a voltage. The current passed by the cell under constant illumination depends only on the voltage applied to the cell; the maximum current is determined by the maximum voltage which can be applied without causing breakdown of the selenium in the gap between the plates.

The amplifying circuits required for selenium cells are very similar to those used with photoemissive cells. A fundamental selenium cell circuit is given in Fig. 13. Light falling on the

selenium cell changes its resistance, thereby changing the bias voltage on the grid of the tube. In the circuit shown, increases in light make the grid of the tube less negative (more positive), because the cell resistance decreases, allowing a larger current and hence a larger voltage drop across  $R$ . This voltage is opposite in polarity to the bias, so it reduces the bias and allows the plate current to increase and operate the relay. With this circuit, therefore, the device being controlled by the relay operates whenever a strong light falls on the cell. (Notice—the response of this circuit to light falling on the cell is similar to that of the circuit in Fig. 5, in which a photoemissive cell is used.) If the positions of the selenium cell and the resistor  $R$  are reversed, the relay will be closed when the cell is dark but will open just as soon as sufficient light falls on the cell.

Selenium cells generally are sealed in moisture-proof cases, because they

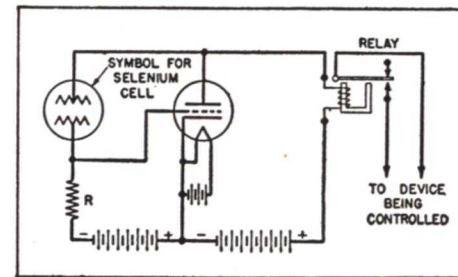

FIG. 13. Notice the symbol used to represent the selenium cell in this basic circuit.

are quite sensitive to changes in humidity. The stability of the cells is in general rather poor; those cells which have a very high sensitivity to changes in light usually have a short life, and their sensitivity changes with use. Mounting in moisture-proof cases also improves cell stability, but with many cells the current passed varies

slightly even with constant illumination. Their power output is limited by the maximum voltage which can be impressed without causing breakdown across the electrodes, and by the amount of heat developed in the cell (excess heat changes the selenium to an insensitive form).

► Selenium cells ordinarily have a time lag and are rather slow to respond to changes in light. It takes several minutes after an increase in

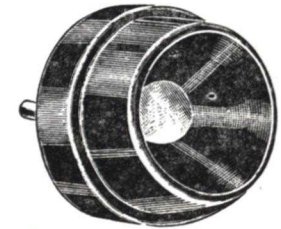

FIG. 14. This H. H. Eby Co. selenium cell is representative of these cells, noted for their small size and for their wide use by experimenters.

light before an ordinary selenium cell will allow maximum current to flow. However, the current reaches 95% of its final value in about .03 second, so the cell is satisfactory for use as a make-break control.

It is possible to change the construction so this cell will respond to light variations (modulations) up to 6000 c.p.s., but the selenium cell is rarely used for audio frequency work.

#### Advantages of Selenium Cells.

Some selenium cells are very sensitive to infra-red light, and so are valuable where control is to be secured with an invisible light beam. Selenium cells can be made to have a low sensitivity to changes in light and a high current-handling ability, or a high sensitivity with low current-handling ability, whichever is desired. Their output is in general considerably greater than that of photoemissive cells. A typical selenium cell is shown in Fig. 14.



## PRECAUTIONS IN USING SELENIUM CELLS

**1. Keep the cell cool.** The heating effect resulting from: 1, too much current through the cell; 2, from exposure to an intense light source; or 3, from using the cell in locations where temperature is excessive, will cause the selenium in the cell to become soft and possibly melt, which makes it unfit for photoelectric use.

**2. Keep the cell dry.** When it is not in use, place it in a dark box containing a few pieces of calcium chloride. The chloride will absorb any moisture which may have collected near the cell.

**3. Avoid high potentials.** Use the

lowest possible voltage which will give the desired results. Choose high-resistance relays or place a limiting resistance in series with the cell to protect it. In general, 4 milliamperes are more than ample for relay work.

Exposure to intense lights for long periods of time should be avoided, for this causes "fatigue" which makes the cell temporarily (and in many cases, permanently) insensitive to light. Cells not in use should be kept in the dark, but should be exposed to light regularly, for short periods of time, to aid in retaining their sensitivity. If the resistance of a cell drops greatly, it can be raised, at least temporarily, by applying pulsating or alternating currents.

## Photovoltaic Cells

Photovoltaic cells are really small batteries or sources of direct current, since they generate a current which varies with the intensity of the light falling on the cell; more correctly, they transform the radiant energy of light directly into electrical energy. Although the voltage output of these cells is quite low, the current delivered is sufficient to operate an indicating meter or a *super-sensitive* relay without the use of any batteries or auxiliary apparatus.

**Types of Photovoltaic Cells.** There are two general types of photovoltaic cells: the *dry* or electronic type, which is today the most common, and the *wet* or electrolytic type. These differ only in the methods of construction and in general characteristics, for each generates its own voltage.

### DRY PHOTOVOLTAIC CELLS

This type of cell consists essen-

tially of a metal disc, perhaps 1/16-inch thick, on one side of which is a film of light-sensitive material; this basic construction is illustrated at A in Fig. 15. The metal disc forms the positive terminal of the cell, and a thin metal film deposited on part or all of the sensitized surface forms the negative terminal. (This film is so thin it is translucent—that is, it will allow light to pass through it.) The action of light forces electrons to the surface of the sensitized layer, where they are collected by the thin metal film which serves as the negative terminal of the cell. The metal disc must make up for the electrons drawn out of the sensitized layer by the action of light by furnishing electrons to the sensitive layer. This loss of electrons makes the disc become the positive cell terminal. A voltage therefore exists across these terminals when the cell is illuminated, and an electron flow will

be in the direction indicated at B in Fig. 15.

Photovoltaic cell circuits are quite simple. The cell is connected directly to the coil terminals of some type of super-sensitive (meter type) relay, as in Fig. 15C. Since the contacts of this relay ordinarily cannot handle the current required by the device to be controlled, they are generally used to control the current to the coil of a sensitive relay. In some cases, the sensitive relay may be used to control a heavy-duty relay.

► While a dry photovoltaic cell can be made in a number of different ways, the following is a typical manufacturing procedure. An iron disc about 2 inches in diameter and 1/16-inch thick is first cleaned thoroughly, then covered on one side with ordinary solder. A thin layer of selenium is deposited over the layer of solder, then the selenium is annealed or heated under

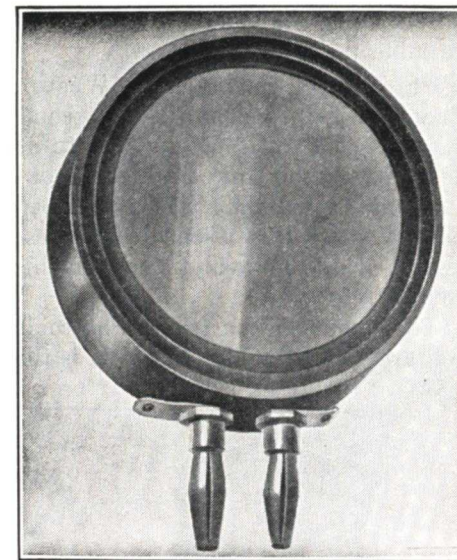

Courtesy Selenium Corp. of America

A typical photovoltaic cell.

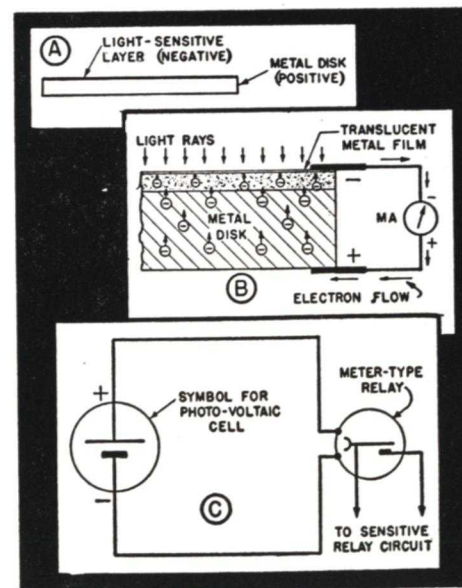

FIG. 15. The construction and operation of the photovoltaic cell differs from that of other cells, particularly in that it generates a voltage without any external battery.

pressure. When the cell has cooled, a thin film of gold, silver, or platinum is deposited on the selenium surface, this film being thin enough to allow light to pass through. This film can be applied as a very thin sheet of the metal (called "gold beater's metal") or can be sprayed on the selenium in molten form from a special spray gun. In some cases the translucent metal film is deposited on the selenium by a process called "cathode sputtering." The cell is completed by making contact to the iron disc and to the translucent metal film with thin metal washers of the same diameter as the iron disc. Naturally the cells must be handled very carefully, because the translucent metal film will rub off very readily. A glass window is customarily set into the cell housing to protect the light-sensitive layer.

Although selenium is used as the light-sensitive element, do not confuse these cells with the selenium photoconductive type. The photovoltaic cell generates a voltage, while the



photoconductive cell acts only as a variable resistance.

**Photronic Cell.** The Weston Photronic cell, one of the first commercial selenium-iron type cells to be developed in the United States, is constructed in much the manner described above; today this is one of the best known of all photovoltaic cells in this country.

The component parts of a Photronic cell are shown in Fig. 16; at A is the

housing. The projecting ends of the bolts are of the same diameter as radio tube prongs, and fit into an ordinary four-prong tube socket.

Characteristic curves for the Weston Photronic cell are given in Fig. 17. The current output varies with the external resistance connected to the cell as well as with the illumination; the output is linear (proportional to illumination) for low values of external resistance. This linear relation for

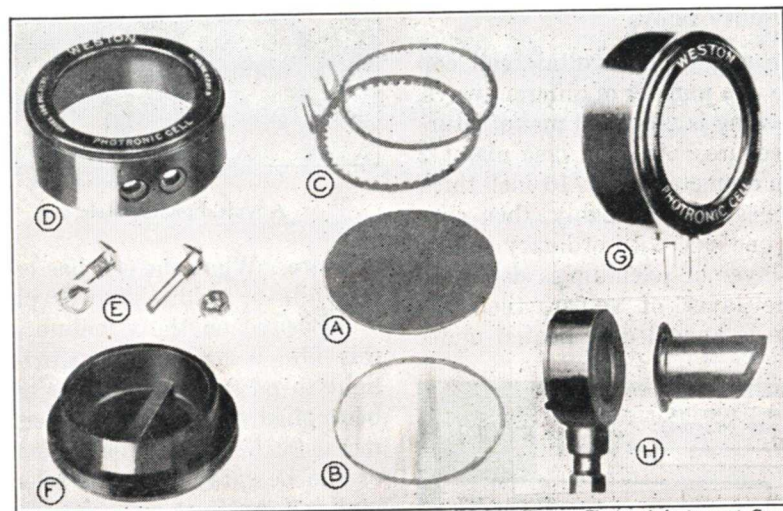

Courtesy Weston Electrical Instrument Corp.

FIG. 16. View of component parts of the Weston Photronic cell, a dry type photovoltaic cell. A—sensitized iron disc; B—glass window; C—metal contact rings; D—bakelite housing; E—terminal bolts; F—bakelite cap; G—assembled cell; H—Photronic cell in weatherproof housing, with visor to keep out unwanted light.

thin disc made of iron, on one side of which is the layer of light-sensitive selenium. The cell is assembled as follows: The glass window is placed in the bakelite housing; the iron disc, with one of the metal contact rings on each side, is placed in the housing next, with the sensitive side against the glass; the contact rings are turned so each terminal lug is over one of the holes in the side of the housing, and the terminal bolts are set into place, heads inside the housing; finally the bakelite cap is screwed into the

low resistances holds true even when the cell is in direct sunlight (about 175 lumens of illumination). It is necessary, therefore, to consider the resistance of meters or relays used with Photronic cells. Low-resistance meters are used generally where it is necessary that the current produced be directly proportional to the light intensity. However, for low values of illumination (below .1 lumen or below 10 foot-candles), a sufficiently linear response can be obtained with instruments having 1000-ohm or higher

resistances, as the curves are practically straight for illumination of such low intensity (see Fig. 17A).

The voltage output of the Photronic cell for varying intensities of illumination, measured by a method which involved no flow of current through the cell, is shown in Fig. 17B. The curve is not linear, and the values of voltage are quite low. This cell, together with all other photovoltaic cells, is not used generally with vacuum tube amplifiers which require large changes in grid voltage to get useful changes in plate current.

The relative color response curve for the Photronic cell, given in Fig. 17C, shows that the cell and the human eye have a maximum response to about the same color, yellow-green. The manner in which a glass window absorbs ultra-violet light can be seen; a much higher response to ultra-violet light is obtained with a quartz window in the cell. Filters (panes of colored glass) which give the Photronic cell almost exactly the same color response as the human eye can be obtained from the manufacturer, and these filters are necessary whenever the cell is to replace the human eye in making measurements of light. The Weston illumination meter, where the cell is connected directly to a microammeter calibrated to read in foot-candles, is an example of this use.

Photronic cells should be used as current sources rather than voltage sources, because the current output of the cell varies directly with the light falling on the cell. In order to obtain a constant voltage from this type of cell, it is necessary to connect a resistance across the cell and take off the voltage across the resistor. This voltage then will be proportional to the light falling on the cell.

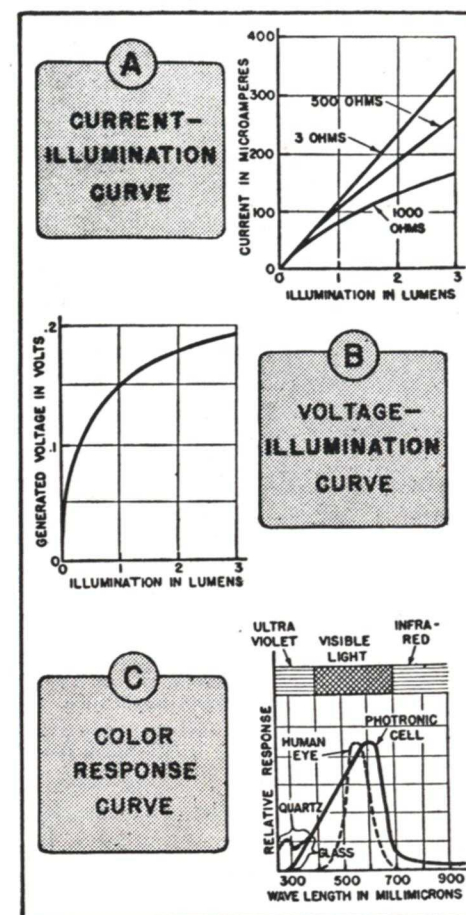
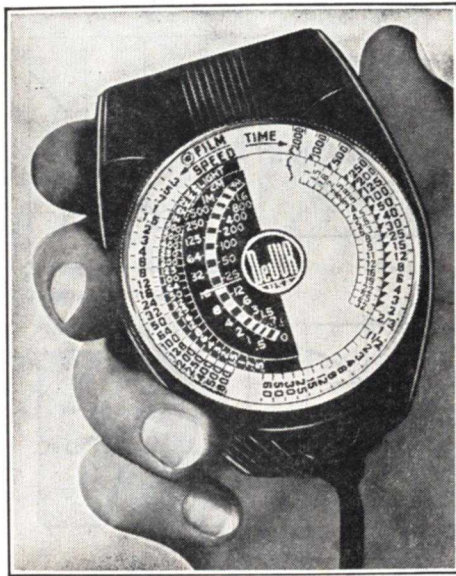

FIG. 17. These characteristic curves are for the Weston Photronic cell, a representative photovoltaic type.

It is possible to connect two or more Photronic cells in parallel to obtain a greater current output for a given intensity of illumination. Connections are exactly the same as for dry cells, minus to minus and plus to plus. The dark resistance of these units is quite high, which means that a number of cells at different points can be connected together in parallel without the possibility of one cell feeding current into the others. The total current delivered by a system made up of a number of dry photovoltaic cells will





Courtesy DeJur-Amseco Corp.

A photovoltaic cell is used in this exposure meter. When pointed at the scene to be photographed, the cell operates a meter, which gives information needed for proper exposure of film. This is an important photoelectric application.

be proportional to the total light falling on all of the cells; for instance, if three cells in parallel furnish 100 microamperes when illuminated by light sources of equal intensity, the combination of cells would give exactly 67 microamperes if one cell were completely darkened. Individual cells have this same characteristic; practically the same current response is obtained when light is concentrated on one part of the cell as when the same amount of light is spread uniformly over the entire active surface.

**The Electrocell.** The Electrocell, a dry disc type of self-generating cell imported from Europe, consists of a light-sensitive layer of selenium deposited on the surface of an iron disc. Contact is made to the layer with a transparent conducting film of silver. Transparent lacquer sprayed over the greater part of the cell protects it from rough handling. The sensitivity of

this cell is 480 microamperes per lumen; in direct sunlight the 1 $\frac{3}{4}$ -inch diameter cell will deliver as much as 20 ma. It is claimed that the Electrocell, in the larger sizes, delivers enough current to operate a sensitive relay directly, thus eliminating the need for an expensive super-sensitive relay. The smallest Electrocells,  $\frac{3}{8}$  inch in diameter, have a sufficiently low capacity to be used for modulations up to 8000 cycles.

**Other Types.** Another type of dry photovoltaic cell which is now on the market, the Westinghouse Photocell, consists of a disc of copper on which has been formed a thin film of cuprous oxide. Contact is made to the copper and to the oxide layer in much the same way as in the selenium-iron type cell. Gold is the material used as the translucent film on this cell.

► The Lange cell, of foreign manufacture, is quite similar in construction to the above-mentioned photovoltaic cells. According to data furnished by the manufacturer, it has a very good current output.

► The General Electric Company's selenium-on-iron type photovoltaic cell is mounted in a bakelite case and provided with prongs which permit its being mounted in an ordinary four-prong radio socket.

**General Characteristics of Dry Photovoltaic Cells.** Dry photovoltaic cells usually are connected directly to super-sensitive relays. These are built much like a milliammeter or microammeter, but have contacts on the moving pointer and fixed contacts on the meter scale. Such relays respond to currents of the order of microamperes, and are therefore quite costly.

For all practical purposes, the response of a dry photovoltaic cell to

changes in light can be considered to be practically instantaneous. Actually these cells are fast enough to detect the passage of a rifle bullet through a beam of light. Because of the high parallel capacity of the cell, however, (about .5 mfd.) dry photovoltaic cells are not suitable for such a use as responding to a light beam which has been modulated at audio frequencies. Photoemissive cells are used more generally for this purpose.

A typical assembly of voltaic cells in parallel is shown in Fig. 18. This connection gives a higher output for a

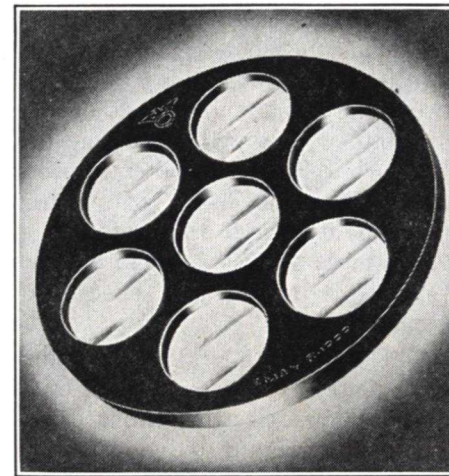

Courtesy Selenium Corp. of America

FIG. 18. A number of photovoltaic cells can be connected together as shown here, giving a far greater output.

given light value, as was explained for the Photronic cell.

The output of a photovoltaic cell can be increased considerably by connecting a small potential, not over 6 volts, in series with the cell. Too high voltages may permanently change the characteristics of the cell. In fact, the manufacturers of the Photronic cell recommend that no external voltages be used if maximum cell life is to be obtained. A photovoltaic cell behaves much the same as a photo-

conductive cell, when an external potential is used in series with the cell.

Dry photovoltaic cells are believed to have an unlimited life; that is, they will retain their characteristics for long periods of time if kept at temperatures below about 120° Fahrenheit. The cells must be tightly sealed in their cases, because they are critically affected by chemical vapors and by dampness.

## WET PHOTOVOLTAIC CELLS

The photovoltaic cell in wet form is now over 100 years old, as its principle, known as the Becquerel effect, was discovered by Edmund Becquerel in 1839. While experimenting with the ordinary type of voltaic cell known in that day, he noticed that his cell gave a much greater output in direct sunlight than in the subdued light of his laboratory.

In its simplest form, the wet photovoltaic cell consists essentially of two metals which are immersed in an electrolyte, with one of these metals or electrodes exposed to a source of light. Research workers have developed two types of wet photovoltaic cells, one in which the electrodes themselves are light-sensitive, and another in which the electrolyte is light-sensitive, but neither type is believed to be of great commercial importance at the present time.

Wet photovoltaic cells can be constructed with a number of different electrode materials and electrolytes. One form has two copper electrodes, on one of which is a film of cuprous oxide. Another type uses one copper electrode on which is a film of cuprous oxide, and one lead plate; the electrolyte is a lead nitrate solution.

The wet photovoltaic cell has a number of drawbacks. In some types, destructive gases are formed while the



cells are standing idle. Industry in general hesitates to adopt equipment like this, in which there is a possibility of leakage of liquid.

Naturally, polarity must be con-

sidered when connecting photovoltaic cells of all types into a circuit, as the cells are really small batteries. In the wet cell, the electrode which has the oxide layer is always *positive*.

## Electron-Multiplier Photocells

A multiplier photocell is a multi-electrode photoemissive cell which uses the principle of "secondary emission" to amplify tremendously the electron stream given off from its cathode when the cathode is exposed to light. The RCA 931-A, a typical multiplier cell, has eleven electrodes—the cathode, nine special anodes known as "dynodes," and the regular anode from which the electron stream passes to the outside circuit.

The dynodes are curved metal plates which are coated on one side with a mixture of chemicals. This coating has the property of emitting electrons when a fast-moving electron strikes it. As many as eight or ten electrons may be emitted from the coating when one electron hits it (the number depends to some extent on the velocity of the electron striking the surface). The electrons given off from the coating are called "secondary" electrons, and the emission itself is known as "secondary emission."

### HOW THE CELL OPERATES

The elements of the RCA 931-A are arranged as shown in Fig. 19. The dynodes—numbered 1 through 9—are maintained at successively higher positive voltages with respect to the cathode, usually in 100-volt steps. That is, dynode 1 is 100 volts more positive than the cathode, dynode 2 is 100 volts more positive than dynode 1, and so on. The dynodes are so

shaped and arranged that electrons from one of them tend to go to the dynode with the next higher number—for example, electrons emitted from dynode 2 will go to dynode 3, those from 3 will go to 4, and so on.

As you can see, dynode 9 practically surrounds the anode. This construction is used because the potential between the anode and the cathode will fluctuate with the load voltage drop and such a fluctuating potential would disturb the movement of electrons from one dynode to the next. Dynode 9, however, acts as a shield and prevents this undesirable effect from occurring.

The anode is a grid rather than a solid plate. This construction of the anode allows electrons from dynode 8 to pass through it to dynode 9; then, because of the geometry of the space around the anode, and because the anode is usually maintained at a potential around 250 volts higher than 9, electrons emitted from 9 are collected by the anode and passed on to the external circuit.

▶ Let's trace the electron path through this cell to see why high current amplification occurs. Light falling on the cathode causes emission of electrons, just as in the regular photoemissive cell. These electrons are attracted to dynode 1. Each of these electrons, when it strikes dynode 1, may cause the emission of up to eight or ten secondary electrons from the

dynode. These secondary electrons are attracted to dynode 2, where each of them causes the emission of several more secondary electrons. This process is repeated all along the electron path through the tube, with each secondary electron from a dynode causing the emission of many others from the next dynode. As you readily can see, the number of electrons flowing in the tube increases enormously as we go from one dynode to the next. In fact, if the tube worked perfectly, with every electron from one dynode going on to the next and causing the emis-

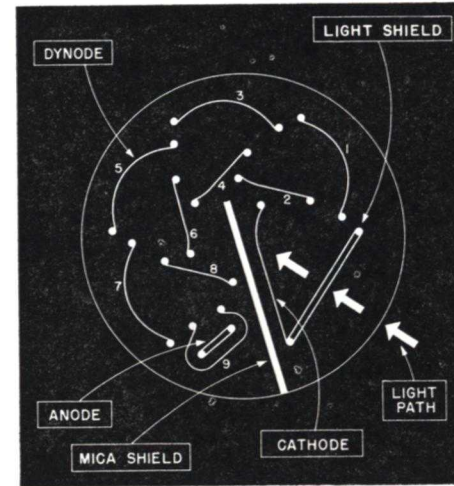

FIG. 19. The electron-multiplier cell contains a number of elements, so shaped and placed that secondary emission tremendously increases the sensitivity.

sion of ten electrons from it, then just one electron emitted from the cathode would cause one billion electrons to arrive at the anode!

Of course, such perfection of operation does not occur, but the tube can be made to produce current amplifications of as much as 200,000 times—which means that 200,000 times as many electrons can be drawn from the anode as are emitted from the cathode. This makes the multiplier photocell by

all odds the most sensitive cell in use today.

### CELL SHIELDING

The mica shield shown in Fig. 19 is used to prevent possible feedback of positive ions from the anode to the cathode. Although the glass envelope in which the tube elements are housed is as well evacuated as is commercially practicable, a small amount of air is left in it, and some of this air may be ionized by the large electron current in the space between the anode and dynode 9. If such ions were able to flow to the cathode or to one of the first dynodes, they would cause secondary emission from these elements which would, of course, be amplified by the other dynodes of the cell. This would make the electron flow through the cell undesirably erratic, and might change the amplifying characteristics of the cell considerably. The mica shield, which allows no ions to pass through it and emits no secondary electrons when struck by ions, prevents the ions from reaching the cathode or any but the highest-numbered dynodes, and so reduces their effects to a minimum.

▶ The light shield (see Fig. 19) is a small grill through which light must pass to reach the cathode. It is used principally to prevent undesired light from reaching the cathode. Also, the grill acts as an electrostatic shield, since it is electrically connected to the cathode.

### CHARACTERISTICS OF MULTIPLIER CELLS

Since the 931-A multiplier cell is an 11-electrode tube, rather than a diode like other photoemissive cells, we must take ten operating potentials into account when we discuss the performance of the cell. This is not really



as complicated as it looks, since the voltage between the cathode and each successively-numbered dynode usually increases by equal steps. (This is not always true: sometimes the voltage step to one dynode is made unequal to the steps to the other dynodes, in order to control the amplification of the tube.) For ease in discussing the cell characteristics, engineers often

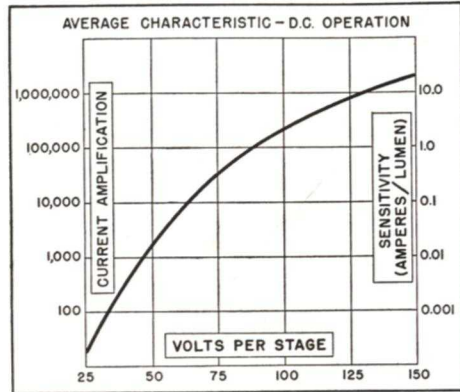

FIG. 20. Sensitivity and gain curves for the electron-multiplier cell.

consider the cell to be an amplifier, with each dynode representing one stage; this allows them to draw characteristic curves in terms of the volts-per-stage used on the cell.

Such a curve is shown in Fig. 20. This shows both the current amplification of the 931-A and its sensitivity in amperes per lumen of light falling on the cathode surface. A comparison of this curve with the current illumination curve for an ordinary vacuum photocell (Fig. 7A) shows you at once how much greater the current output of the multiplier cell is. At an illumination of 1 lumen, for example, the vacuum photocell has a current output of about 12.5 microamperes. The 931-A multiplier cell, operated at 100 volts per stage (a usual operating potential), has a sensitivity of 2

amperes per lumen—that is, an illumination of 1 lumen on its cathode would produce a current output of 2 amperes. The current output of the multiplier is thus 160,000 times as great as that of the photocell for the same amount of illumination!

This, however, does not mean we can draw 2 amperes out of multiplier cell; such a high current would ruin the cell at once. The maximum rated current output of the 931-A cell is 2.5 milliamperes. The high sensitivity

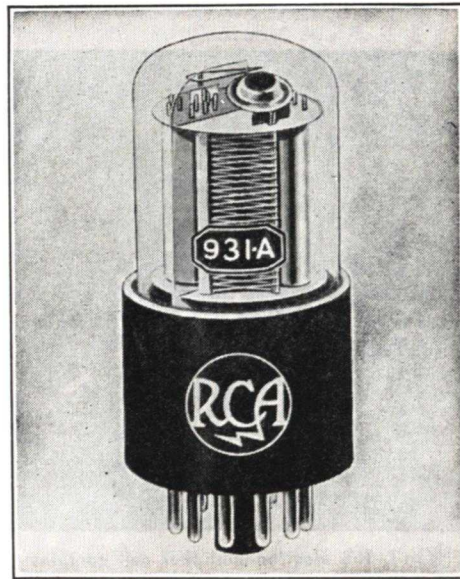

Courtesy RCA Mfg. Co.

A typical electron-multiplier cell is shown here.

means we must be sure never to expose the cell to too much light—it might be ruined.

Under normal operating conditions, the output current of the multiplier cell is directly proportional to the illumination. The response of the cell when illuminated by a modulated light beam is perfectly flat up to extremely high frequencies of modulation. The amplifying action of the tube has no adverse effect on its fre-

quency response, because secondary emission from the dynodes occurs instantaneously when they are struck by electrons. At very high frequencies, however, the fact that the electrons take a definite time to move from one element to the next limits the response of the cell. As Fig. 21 shows, the

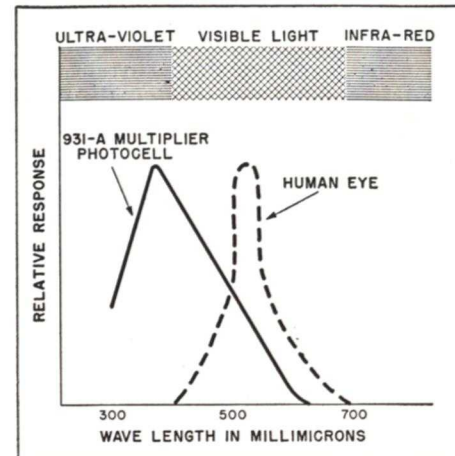

FIG. 21. Color response curves for the electron-multiplier cell.

color response curve of the 931-A cell has a peak in the ultra-violet region and drops off rather rapidly on either side of this peak.

**Power Supply Requirements.** Multiplier cells have one disadvantage not shared by other kinds of light-sensitive cells — high voltages are necessary to operate them. The anode may be as much as 1250 volts above the potential of the cathode. Naturally, such high voltages are dangerous, and you should take all possible safety precautions if you work with such a cell. Apparatus using these cells is usually designed so that it is hard to reach the high-voltage electrodes, and so that the primary circuit of the high-voltage power supply must be broken before you can get at the cell. Whenever possible, the

positive high-voltage terminal of the voltage supply circuit (connected to the anode of the cell through the load) is grounded; the cathode, connected directly to the negative terminal of the supply, then operates below ground (highly negative with respect to ground). This allows the high-voltage section of the circuit to be safely enclosed, while the output section (the part of the circuit you are most apt to touch) will be fairly close to ground potential. Of course, if the circuit happens to be defective, high voltages may appear anywhere in it—so you should always shut off the

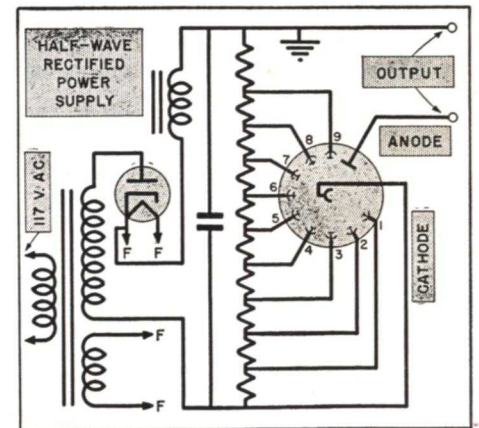

FIG. 22. Where d.c. is wanted for operation of an electron-multiplier, a circuit like this one can be used.

power and discharge any charged condensers before touching any part of the circuit.

Ordinarily, the operating voltages for the various stages of a multiplier cell are obtained from a tapped voltage divider which is placed across either a full-wave or a half-wave rectified source of current. A simple half-wave power supply circuit for the cell is shown in Fig. 22. A cell also can be run directly from an a.c. source, using a circuit like that in Fig. 23.



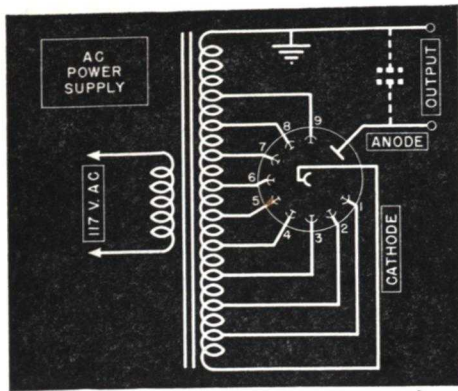

FIG. 23. A.C. voltages can be used as the operating voltage for many applications of the electron-multiplier cell.

This circuit is particularly suitable for relay operation.

► A magnetic field, as you know, can

change the direction of an electron stream. For this reason, it is sometimes necessary to shield a multiplier cell magnetically when it is operated near a strong magnetic field, so that the field will not interfere with the desired flow of electrons from dynode to dynode.

► In addition to its enormous sensitivity, the 931-A multiplier cell has a low noise level, low dark current, and freedom from distortion. Practical applications of the cell include the operation of relays, sound reproduction from film, facsimile transmission, and scientific research involving low light levels. This cell is a recent development and is now coming into more widespread use.

THE N. R. I. COURSE PREPARES YOU TO BECOME A  
**RADIOTRICIAN & TELETRICIAN**  
(REGISTERED U.S. PATENT OFFICE) (REGISTERED U.S. PATENT OFFICE)

## Lesson Questions

Be sure to number your Answer Sheet 25FR-3.

Place your Student Number on every Answer Sheet.

Send in your set of answers for this lesson immediately after you finish them, as instructed in the Study Schedule. This will give you the greatest possible benefit from our speedy personal grading service.

- Name the six basic parts of a complete photoelectric installation.  
LIGHT SOURCE + LIGHT BEAM APPARATUS + PHOTO ELECTRIC CELL  
 + PHOTO ELECTRIC AMPLIFIER + SENSITIVE RELAYS + HEAVY DUTY RELAYS.
- What two kinds of light are invisible to the human eye, yet can be "seen" by a photoelectric cell?  
ULTRA VIOLET LIGHT  
 INFRA RED LIGHT
- Name the four classes of light-sensitive cells.  
PHOTO MISSING CELLS + PHOTOCONDUCTIVE CELLS + PHOTOVOLTAIC CELLS  
 + ELECTRO-MULTIPLIER-CELLS
- If the photocell and resistor *R* are interchanged in Fig. 5, will the relay close when: 1, the photocell is *lighted*; or 2, when the photocell is *darkened*?
- What is the maximum safe operating voltage of the average gas type photo-emissive cell?  
100 V
- Which of the light-sensitive cells will operate a super-sensitive relay *without* the use of a battery or an amplifier?  
PHOTOVOLTAIC CELLS
- What is used with a Photronic cell to make it have exactly the same color response as the human eye?  
FILTERS
- How would you connect two or more Photronic cells to secure a greater current output for a given intensity of illumination?  
PARALLEL
- What basic principle is used in the electron-multiplier cell to obtain a high light-sensitivity?  
THE ELEMENTS
- How may the amplification of an electron-multiplier cell be varied?  
MICA SHIELD





## ACTION SPEAKS FOR ITSELF

*Be sure you are right, then go ahead*—this has been the motto of many of the world's great men.

In most cases you know instinctively what is right, your decision being based upon your past training, your experience, your common sense and your conscience. In these cases, *act!* Waste no valuable time arguing with others who know less than you; waste no time trying to “pound” your ideas into a cynical world—take the initiative yourself.

It is a thousand times better to *do things* and let your deeds speak for themselves than to spend time explaining why your proposed course of action is right. Friends can hinder your success if you take time to justify your actions to each one of them.

If you need advice—if you are not exactly certain you are right, then go to men who are capable of giving authoritative answers to your questions. You'll find that successful men are glad to answer serious, well-planned questions. Analyze their advice in connection with your own experiences, make your decision, then act!

Give this plan a tryout. You will accomplish a great deal more work, and you will be a lot happier.

*J. E. Smith*