

**PEAK AND BAND-PASS  
R. F. TUNING CIRCUITS**

22FR-2

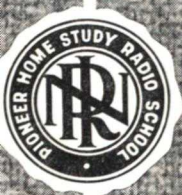

**NATIONAL RADIO INSTITUTE**

**WASHINGTON, D. C.**

**ESTABLISHED 1914**



# STUDY SCHEDULE No. 22

For each study step, read the assigned pages first at your usual speed. Reread slowly one or more times. Finish with one quick reading to fix the important facts firmly in your mind, then answer the Lesson Questions for that step. Study each other step in this same way.

- 1. Importance of Response Curves; General Analysis of a Modulated R.F. Carrier; Analyzing Typical Response Curves . . . . . Pages 1-6

This general information on response curves prepares you for speedier understanding of the actual tuning circuits taken up in the rest of the lesson. Study this section thoroughly. Answer Lesson Questions 1, 2 and 3.

- 2. Factors Controlling Response; Coupling Methods for R.F. Tuning Circuits . . . . . Pages 6-11

Here is where you begin studying in detail exactly how coils and condensers work together to permit passage of the desired signal while rejecting all other signal frequencies. Answer Lesson Questions 4, 5 and 6.

- 3. Directly Coupled Resonant Loads; Tuned Secondary Transformer Loads . . . . . Pages 11-16

This section should not prove at all difficult if you realize right from the start that your goal now is simply understanding the material. Don't try to memorize it, because you can always review this material later, and can refer to it when in need of specific facts. Answer Lesson Question 7.

- 4. Double-Tuned Transformer Loads; Double-Tuned Capacity-Coupled Loads . . . . . Pages 16-23

You'll find quite a bit of practical information here, along with more r.f. tuning circuit data. Answer Lesson Questions 8, 9 and 10.

- 5. Combination Capacitive and Inductive Couplings; Tuned Secondary with Fixed Tuned Primary Circuit; R.F. Tuning Circuits Used in Actual Receivers . . . . . Pages 23-28

Pay particular attention to the section covering a fixed tuned primary circuit, because this scheme is used in a great many table model receivers. The actual tuning circuits at the end of this lesson illustrate many of the important principles previously studied.

- 6. Mail Your Answers for This Lesson to N.R.I. for Grading.

- 7. Start Studying the Next Lesson.

COPYRIGHT 1946 BY NATIONAL RADIO INSTITUTE, WASHINGTON, D. C.

FM8M1249

1950 Edition

Printed in U.S.A.

# Peak and Band-Pass R. F. Tuning Circuits

## Importance of Response Curves

**P**RACTICAL radio men are today more concerned than ever before with the shapes of the resonant response curves for R.F. amplifiers, for they have come to realize that these curves reveal the exact characteristics of a receiver or transmitter and tell when undesirable effects have been in-

sired gain and fidelity within the limitations of the tuning circuits. A thorough understanding of the peculiar characteristics of R.F. tuning circuits and an ability to read the story told by each shape of response curve will prove particularly valuable when using a cathode ray oscilloscope for radio receiver testing and servicing.

You are already familiar with peak

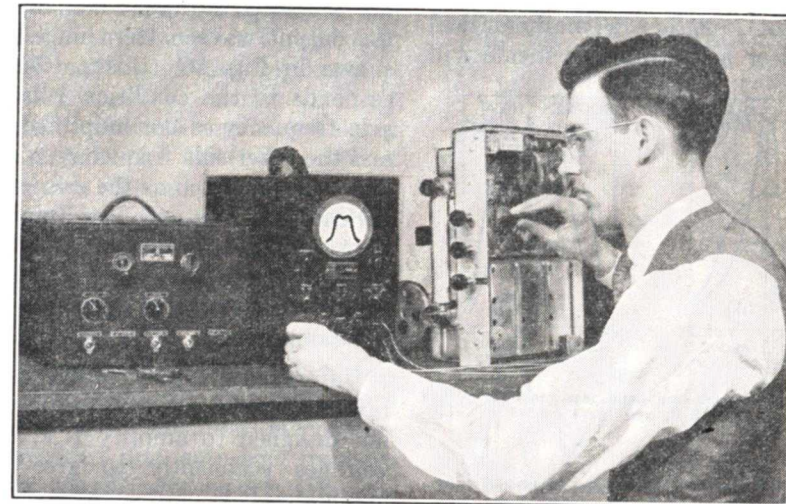

All-wave superheterodyne receiver being aligned for band-pass response, using a frequency-wobulated R.F. signal generator (extreme left) and a cathode ray oscilloscope. The final double-peak response curve, secured after all adjustments are made, can be seen on the screen of the cathode ray tube. Note that the receiver chassis is set on end, for convenience in making connections and adjusting under-the-chassis trimmer condensers.

duced by adjustments or by defects in circuit parts.

Older receivers, as well as a great many modern receivers, use R.F. tuning circuits which are adjusted for peak response. On these receivers a serviceman need only adjust for maximum output, never giving a thought to the shape of the peak response curve. A modern high-fidelity radio receiver has band-pass R.F. tuning circuits, however, and actual viewing of the response curve greatly simplifies the adjusting of the receiver to give the de-

response curves like those shown in Fig. 1A, for they have been discussed in previous lessons. You know that a sharp peak response curve for an R.F. amplifier indicates high gain and high selectivity, while a broad peak response represents somewhat lower gain and lower selectivity but better fidelity. Likewise you are familiar with the band-pass response curves shown in Fig. 1B, and know that R.F. tuning circuits having these curves give better fidelity at the expense of gain. In this lesson we will study in detail the tuning



circuit conditions which give to an R.F. amplifier any of these four response curves or any of the many possible variations of these curves.

### General Analysis of a Modulated R.F. Carrier

If we used a special cathode ray oscilloscope to analyze an R.F. carrier which is 100% modulated with a single sine wave signal (of frequency  $f_m$ ), we would see on the screen of the cathode ray tube a pattern much like that in Fig. 2A (the dotted lines indicating the modulation envelope would of course be absent). Either a mathematical analysis or actual measurements will

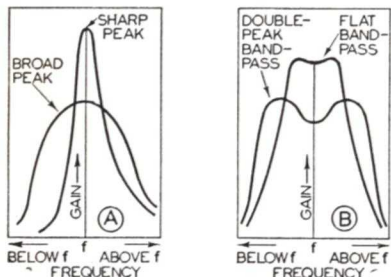

FIG. 1. Typical peak and band-pass response curves of R.F. amplifiers.

show that we really have three different R.F. signal frequencies in this modulated carrier, as indicated in Fig. 2B:

- $f$ , the R.F. carrier frequency
- $f_1$ , the lower side frequency, which is equal to the carrier frequency minus the modulation frequency ( $f_1=f-f_m$ )
- $f_2$ , the upper side frequency, which is equal to the carrier frequency plus the modulation frequency ( $f_2=f+f_m$ )

Furthermore, with 100% modulation the voltage of each side frequency signal will be *exactly one-half* that of the carrier signal. (With less than 100% modulation, the amplitude of each side frequency will be *less than one-half* that of the carrier.) In dealing with R.F. tuning circuits, we must consider all three of these R.F. signals, for

the side frequencies must be amplified the same amount as the carrier frequencies if distortion is to be avoided.

When a 100%-modulated R.F. carrier is sent through an R.F. amplifier which has a perfectly flat top response, the side frequencies will be amplified equally as much as the carrier and the output wave pattern will be identical to the input wave pattern. If, however, we send this 100%-modulated R.F. carrier through a tuned R.F. amplifier which is considerably off tune, severe amplitude distortion occurs because the side frequencies and the carrier are amplified different amounts, and the output wave pattern might be as shown in Fig. 2C (this pattern corresponds to the condition where one side frequency is not amplified at all and the other side frequency is amplified twice as much as the carrier; Fig. 2D indicates the output voltage relationship under this condition). Output wave patterns thus tell directly whether distortion is occurring in an R.F. amplifier.

Unfortunately the average cathode ray oscilloscope used by servicemen is not designed to amplify R.F. carrier voltages sufficiently to give useful modulated R.F. patterns on the screen: an extra R.F. amplifier would have to be used, or a costly and bulky laboratory type oscilloscope secured. A response curve of the R.F. amplifier in question gives essentially the same information about distortion, however, and is easily produced with an ordinary radio servicing oscilloscope. A typical peak response curve is shown in Fig. 2E; this curve tells how much amplification the side frequencies will get at any modulation frequency value. Each response curve has a story to tell you; to show how these stories can be read, we will consider a typical example in which the carrier frequency is assumed to be 1,000 kc., with 100% modulation.

When the modulation frequency is 100 cycles, the side frequencies will be 999.9 kc. and 1,000.1 kc.; by referring to Fig. 2E, where these side frequencies are designated as  $f_3$  and  $f_4$ , we can readily see that these will receive essentially the same amplification (gain) as the 1,000 kc. carrier. This means that after the modulated signal has passed through the R.F. amplifier, the two side frequencies will each be the same fraction of the carrier voltage (one-half in this case of 100% modulation) as they originally were.

With a 5,000-cycle modulation signal, however, the resulting 995 kc. and 1,005 kc. side frequencies ( $f_1$  and  $f_2$  in Fig. 2E) receive considerably less amplification than the carrier ( $f$ ); this means that after the modulated signal has passed through the R.F. amplifier, the two side frequencies will be a considerably lower fraction of the carrier voltage than they originally were (each will be *less than one-half* the carrier voltage in our case of 100% modulation). With only one modulation frequency, this attenuation of side frequencies is simply equivalent to a reduction in the modulation percentage, provided that both side frequencies are equally attenuated; after demodulation, then, the 5,000-cycle audio signal voltage will be lower than if there were no attenuation of side frequencies.

**Frequency Distortion.** When a number of different modulation frequencies ranging from 0 to 5,000 cycles (such as we have in radio receivers which are tuned to sound broadcasts) are present in an R.F. amplifier having the response curve in Fig. 2E, there will be a large number of side frequencies in the range from 995 kc. to 1,005 kc. Those farthest away from the carrier frequency, corresponding to the higher modulation frequencies, will be amplified the least, with the result that a certain amount of frequency distortion

will be present in the audio signal after demodulation. If not too severe, this frequency distortion can be corrected in a receiver by the use of equalizing circuits which make the audio amplifier provide increased amplification for those higher modulation frequencies which were cut down in the R.F. tuning circuits. Servicemen often use this little equalizing trick to com-

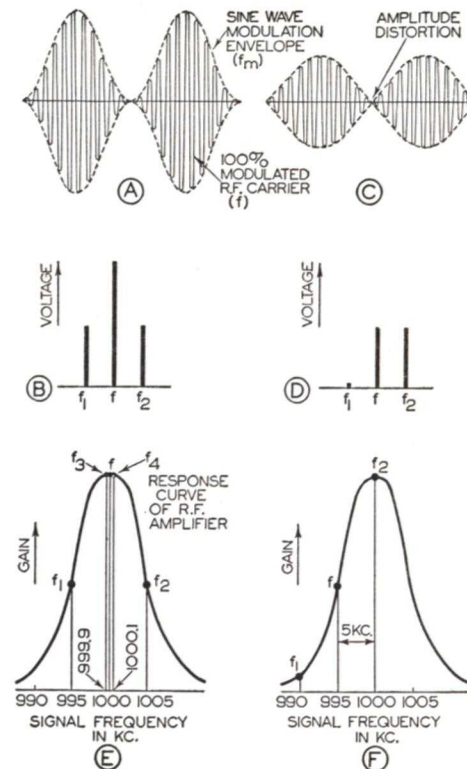

FIG. 2. These diagrams tell you what happens to a modulated R.F. carrier signal when the R.F. amplifier is properly tuned (A, B and E) and when it is improperly tuned (C, D and F.)

pensate for frequency distortion in a highly selective R.F. amplifier. In television circuits the modulation frequencies may range from 0 to over 2.5 megacycles, and the amount of equalization required in picture signal amplifiers may therefore be quite great.

**Amplitude Distortion.** When the side frequencies associated with an R.F. carrier are attenuated or cut down



unequally by a tuning circuit (so that with a single modulation frequency, one side frequency will have a greater amplitude than the other), *amplitude distortion* as well as frequency distortion will be present. This fact is not so easily shown without mathematics, but by considering the extreme case where only one side frequency is allowed to pass, the other being cut out entirely by the tuned circuit, we can get some idea as to why this statement holds true.

Suppose that the R.F. amplifier in our previous example is tuned to 1,000 kc. but is fed with a 995 kc. carrier modulated at 5,000 cycles (5 kc.); now we have the condition represented by Fig. 2F, where the upper side frequency (1,000 kc.) is fully amplified, the carrier is amplified about half as much, and the lower side frequency receives hardly any amplification at all. The R.F. amplifier under this condition allows only one side frequency to pass through with the carrier, as was indicated in Fig. 2D; both will have the same amplitude at the output, and the wave form of the amplifier output voltage will be as shown in Fig. 2C. (Originally, as in Fig. 2B, the amplitude of the carrier  $f$  was twice that of the upper side frequency  $f_2$ ; reducing the carrier amplitude one-half without reducing the amplitude of  $f_2$  thus makes both amplitudes equal.

Observe that the outer peaks of modulation in Fig. 2C have sine wave shapes, but the valleys or troughs are V-shaped; this is clearly a case of amplitude distortion, for the modulation envelope no longer corresponds to the sine wave modulation signal (like that in Fig. 2A) at the input of the tuning circuit. (The curve in Fig. 2C was obtained by adding together and plotting the values of the carrier and the side frequency at each instant of time; it can be verified with a cathode ray oscilloscope and suitable special

laboratory equipment.) Lower percentages of modulation than 100% and different off-tune carrier frequencies will of course give slightly different wave forms for the envelope in Fig. 2C, but amplitude distortion will be evident in all cases.

You can expect distortion similar to that in Fig. 2C whenever a tuning circuit is not properly tuned to the input carrier or when it has an unsymmetrical resonant curve, for both conditions result in unequal amplification of upper and lower side frequencies. The resulting amplitude distortion cannot be corrected for in the audio system; it will be present in the receiver output, and will often be annoying to the radio listener. The elimination of amplitude distortion in the R.F. system is therefore a matter of vital importance to the radio serviceman as well as the receiver designer.

### Analyzing Typical Response Curves

Four typical resonant response curves of actual radio receivers, such as might be obtained by using a cathode ray oscilloscope and the necessary associated equipment, appear in Fig. 3. In each case  $f$  represents the carrier frequency to which the R.F. amplifier is tuned, while  $f_1$  and  $f_2$  represent the lowest and highest side frequencies involved. When properly interpreted, these curves reveal considerable information about distortion.

**Sharp Peak.** An R.F. amplifier having the sharp peak response curve shown in Fig. 3A will cause severe attenuation of the higher modulation frequencies (severe frequency distortion). (Remember that low modulation frequencies correspond to side frequencies close to and both above and below  $f$ , while high modulation frequencies correspond to side frequencies near  $f_1$  and  $f_2$ .) Since the gain at  $f_1$  is less than at  $f_2$  in this example, some amplitude dis-

tortion is also to be expected; this may not be severe, since the difference between the two values is not great. In R.F. amplifiers which have peak response curves, the greatest amount of amplitude distortion occurs because of improper tuning, which gives the condition represented by Figs. 2C, 2D and 2F. It is primarily for this reason that highly selective receivers, which naturally have sharply peaked response curves, are equipped with tuning aids.

**Rounded Peak.** Rounding or broadening of the peak of a response curve, by cutting down the amplification in the vicinity of the carrier frequency more than at the extreme side frequen-

than the other, with resulting amplitude distortion. Furthermore, if the valley between the peaks is too deep, the lower modulation frequencies (having side frequencies in this valley) will be attenuated and frequency distortion will be evident.

**Symmetrical Double Peak.** When a serviceman adjusts a band-pass tuning circuit for high fidelity and good selectivity, his goal is the rarely-attained ideal square top response curve; ordinarily, however, he is entirely satisfied if he can secure the symmetrical double peak response curve shown in Fig. 3D, which has a negligible valley between the peaks. He knows that

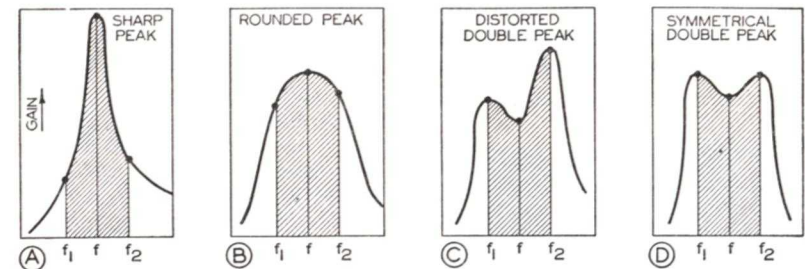

FIG. 3. These four response curves are representative of those which can be viewed on the screen of a cathode ray oscilloscope when actual R.F. and I.F. amplifiers are being tested. The shaded areas and vertical lines are of course not seen on the C.R.O. screen; they have been added here in order to show the range of side frequencies handled by the amplifier along with the carrier in each case.

cies, is easily accomplished by a service technician who understands R.F. tuning circuits. The result is a broad peak response curve similar to that shown in Fig. 3B, which gives considerably less frequency distortion at the expense of selectivity and gain.

**Distorted Double Peak.** Band-pass R.F. tuning circuits will, if properly designed and adjusted, give a double peak response curve with steep sides, insuring good fidelity and selectivity. Unless the adjustments are carefully made, however, there is a possibility that a distorted double peak response curve like that shown in Fig. 3C, in which one peak is higher than the other, will be obtained. Naturally a curve such as this is undesirable, for one side frequency is amplified more

when an R.F. amplifier has a symmetrical double-peak response curve such as this, amplitude distortion will not occur and frequency distortion will be negligible in the R.F. or I.F. amplifier. A properly designed band-pass tuning circuit can give far better selectivity than a circuit having a peak response which has been broadened to give equally as good fidelity. (The steeper the sides of the response curve outside the  $f_1$ - $f$ - $f_2$  region, the better is the selectivity.)

**Alignment of R.F. Tuning Circuits.** The final factory inspection of a radio receiver generally includes a check of the response curve for the R.F. section, to make sure that it has the desired shape. This is referred to as a check of the alignment. Oftentimes this align-



ment may be disturbed by rough handling during shipment and by general aging of the receiver, making it necessary for the serviceman to realign the tuning circuits.

It is a well-known fact that most radio receivers are designed to have a compromise between selectivity, gain and fidelity, so they will please the greatest possible number of listeners. It is when a particular listener wants the highest possible fidelity or wants maximum gain and selectivity for reception of distant stations that the serviceman is called in to change this compromise response characteristic. Realigning a receiver to have a sharp-peak response gives maximum possible gain and selectivity; usually this is easily done with an ordinary all-wave

which control the response characteristic.

### Factors Controlling Response

The shape and height (maximum gain) of the response curve for a tuned R.F. amplifier are essentially determined by one or more of the following factors: 1, *The Q factors of the coils used in the amplifier*; 2, *the L/C ratio of each tuned circuit in the amplifier*; 3, *the types of coupling used to connect the tuned circuits to each other and to vacuum tubes*; 4, *the characteristics of the vacuum tubes*. Although these factors have been discussed to a certain extent in previous lessons, they are so important to our study of tuning circuits that I will review them briefly at this time.

*Q Factor of a Coil.* In previous les-

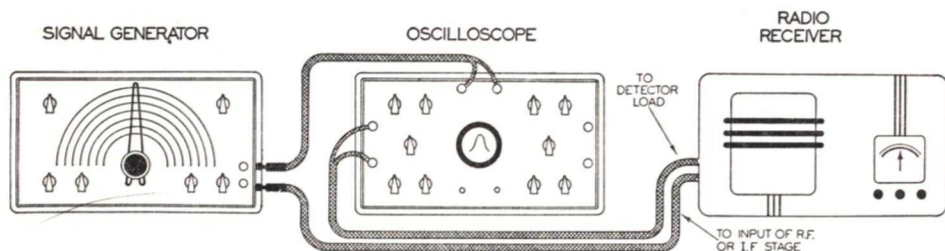

The response curve of the radio receiver at the right appears on the screen of the cathode ray tube in the radio servicing oscilloscope (center) when proper connections are made between the receiver, the oscilloscope and the frequency-wobulated R.F. signal generator at the left.

signal generator and an output indicator. Correct aligning for high fidelity cannot be easily carried out without additional equipment, however; a frequency-wobulated signal generator\* and a cathode ray oscilloscope are essential in this case. It is not the purpose of this lesson to describe the service procedures followed in realigning radio receivers, but rather to point out the various factors in tuned circuits

\*A frequency-wobulated signal generator is a special type of R.F. signal generator whose output frequency can be made to vary regularly and automatically above and below a definite R.F. value to cover any desired range of side frequencies.

sions it was pointed out that any tuning circuit has a certain amount of loss due primarily to the A.C. resistance of the coil (the resistance of the condenser and the circuit wiring is so low that it is usually neglected entirely). The ohmic value of this A.C. resistance of a coil depends not only upon the D.C. resistance of the wire used in making the coil, but also upon "skin effects" associated with high frequency currents, upon losses occurring in the dielectric materials used for the coil form and insulation, and upon the nature of the load which is coupled to the coil. The Q factor of a coil was de-

$$Q \text{ factor of a coil} = \frac{\text{Coil reactance in ohms}}{\text{Coil A.C. resistance in ohms}}$$

defined as the *coil reactance divided by this coil A.C. resistance*, all values being measured at the same frequency. Furthermore, since it is the coil which controls the tuning circuit losses, the Q factor of the coil can be considered as the Q factor of the entire tuning circuit.

*What Q Factor Tells Us About Tuning Circuits.* The Q factor of the coil in a tuning circuit is a numerical value, often referred to simply as Q; it tells us the following important facts about the two types of tuning circuits:

#### Series Resonant Circuits—

1. At resonance, the A.C. voltage across the coil is Q times the source voltage.
2. At resonance, the impedance of the tuned circuit is entirely resistive, and is equal to the impedance of the coil in ohms divided by the Q factor of the coil.

#### Parallel Resonant Circuits—

1. At resonance, the current through the coil is Q times the source current.
2. At resonance, the impedance of the tuned circuit is Q times the coil impedance, and is entirely resistive.

Up to a few years ago, engineers and scientists discussed the behavior of tuned circuits in terms of the A.C. resistance of the coil; this practice is quite correct, and may still be found in many text-books. Modern engineers

\*Q factor is actually the reciprocal of power factor. You will remember from previous Lessons that the power factor of a device is equal to its resistance divided by its impedance; where the impedance is essentially reactance, power factor can be considered equal to resistance divided by reactance, just as Q factor is equal to reactance divided by resistance under the same conditions. You can always find the Q factor of a device (if the power factor is known) by dividing the number 1 by the power factor. Good coils and condensers have a high Q factor and a low power factor; good resistors have a low Q factor and a high power factor.

prefer to think in terms of Q factor, however, since they now have instruments with which they can measure the Q factor of a coil directly.\*

One of the instruments available for measuring the Q factor of a coil is shown in Fig. 4; it is known as a Q factor meter, and can also be used for measuring the Q factor of any resistor or condenser.

In a coil or condenser the radio engineer desires pure reactance at any frequency, with no resistance to cause loss of useful power, and consequently he wants the Q factors of these parts (the ratios of reactance to resistance)

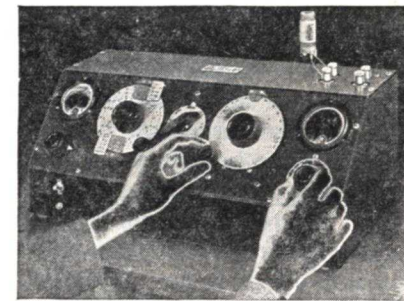

Courtesy Boonton Radio Corp.

FIG. 4. This Q-factor meter is typical of the instruments used by radio engineers for measuring the Q factor of coils, condensers and resistors. The device being measured (a coil in this case) is connected to two of the terminals at the top of the instrument.

to be as high as possible in most cases. The Q factor meter reveals that the Q factors of condensers are very high (resistance is very low) in comparison with coils; the meter can also be used to compare various coils (or condensers) as to quality.

Although a resistor is ordinarily thought of as a pure resistance, it often has appreciable inductance, particularly when of the wire-wound type. The Q factor of a resistor (the ratio of



## REVIEW DATA FOR A.C. CIRCUITS

**Resistance.** That opposition to current flow in an A.C. circuit which results in power loss; it is often called A.C. resistance.

**Reactance.** That opposition to current flow in an A.C. circuit which does not result in power losses. Reactance may be either inductive (due to a coil or inductance) or capacitive (due to a condenser or capacitance).

**Impedance.** The total opposition to current flow in an A.C. circuit. Impedance combines the effects of both resistance and reactance, and therefore determines how much alternating current will flow.

When the resistance of a device is very small with respect to its reactance, as in coils and condensers, the impedance will be just slightly larger than the reactance, and for all practical purposes we can consider the impedance and reactance to be equal.

reactance to resistance) should therefore be as low as possible in circuits where only resistance is desired.

**How to Increase the Q Factor of a Coil.** For a coil of given inductance, keeping the losses in the coil at a minimum insures a high Q factor. Losses which are due to capacity between the turns of the coil can be reduced by using insulating materials and coil coatings which have low dielectric losses. Losses due to the coil form can be reduced by improving the quality of the material used in the coil form. Losses due to skin effects in the wire at high frequencies can be reduced by using a large number of enamel-covered wires which are braided together to form what is known as "litz" wire. (Unfortunately, litz wire is valuable only at frequencies between about 200 and 900 kc.) At high frequencies, losses can be kept down by making the coil with large solid wire, with flat copper ribbon or with copper tubing, all turns being equally spaced.

The shape of a coil has considerable effect upon its Q factor, for coil losses vary with the shape of the coil, particularly when the winding is in several layers. When designing multi-layer R.F. coils, radio engineers generally test out several shapes and select

that which gives the highest Q factor for the coil.

Shielding an R.F. coil by placing it in a metal can or compartment increases the losses in the coil, reduces the coil inductance, and also reduces the coil Q factor. With a Q factor meter like that shown in Fig. 4, the designer can select a shield for a given coil which will not excessively reduce the Q factor.

Large coils which are made from heavy copper wire, tubing or ribbon can have Q factors of over 500. In radio receivers, where small coils must be used because of space limitations, Q factors of 150 are considered excellent; in order to obtain this high value for radio receiver coils, it is necessary to use coil forms at least two inches in diameter and use heavy solid wire or litz wire for the windings.

Even though an engineer is able to choose a coil size, shape and type of wire which will keep losses low and thus give a high Q factor at a particular frequency, this is no guarantee that the Q factor will remain high for other frequencies. The graph in Fig. 5 shows that *the Q factor of a practical coil varies with frequency*. This graph tells us that in general, a coil which has a very high Q factor at a low frequency

will lose its Q factor rapidly at higher frequencies (curve 1), whereas a coil with a reasonably high Q factor at low and medium frequencies will tend to retain this Q factor value as frequency is increased (curve 2 in Fig. 5). Naturally these facts about how the Q factor for a coil varies with frequency are of extreme importance in connection with the tuning circuits of radio receivers, for these circuits are made to respond to a wide range of carrier frequencies.

**L/C Ratio for Tuning Circuits.** In a tuning circuit the ratio of coil inductance to condenser capacity, commonly known as the L/C ratio, oftentimes has an important effect upon the selectivity of the circuit, determining the ability of the circuit to reject frequencies which differ from the resonant frequency. In series resonant circuits a large L/C ratio (secured by using a high-inductance coil) gives best selectivity, but in parallel resonant circuits it is the lowest L/C ratio which gives the best selectivity (assuming, of course, that the losses in the coils are the same for all L/C ratios).

When comparing the L/C ratios for two different tuning circuits, it is important that the same unit of inductance be used for each coil and the same unit of capacity be used for each condenser. For example, a typical 500-to-1,500 kc. tuning circuit uses a 250 microhenry coil and a 400 micro-microfarad (mmfd.) maximum capacity variable condenser; with this condenser set at 100 mmfd., the L/C ratio is  $250 \div 100$ , or 2.5. For comparison purposes, then, the capacity and inductance used in another circuit should be expressed in these same units when figuring out the L/C ratio.

## Coupling Methods for R.F. Tuning Circuits

The method used for coupling an R.F. tuning circuit to a tube in an R.F. amplifier or for coupling two tuning

circuits together naturally has a great deal to do with the operation of the amplifier. Four basic coupling methods are in general use:

**Method 1. Directly coupled resonant load** like that in Fig. 6A, where a parallel resonant circuit is directly connected to the plate of the amplifier tube.

**Method 2. Tuned secondary transformer load** like that in Fig. 8A, where a series resonant circuit is inductively coupled to the plate of the amplifier tube.

**Method 3. Double-tuned transformer load** like that in Fig. 9A, where two resonant circuits which are mutually coupled inductively serve as the plate load for the amplifier tube.

**Method 4. Double-tuned capacity-coupled load**, like that in Fig. 11A, where two resonant circuits which are mutually coupled capacitively serve as the amplifier tube plate load.

**Coefficient of Coupling.** We are particularly interested in the amount of coupling provided between the resonant load circuit and the plate circuit of the R.F. amplifier tube by each of the basic coupling methods. Direct coupling such as that in method 1 pro-

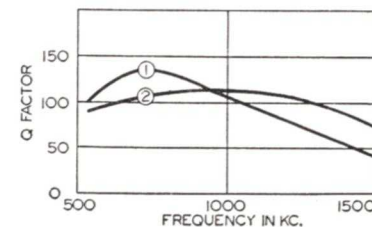

Fig. 5. Chart showing how Q factor varies with frequency for two representative broadcast band coils.

vides maximum possible coupling between the source (the vacuum tube plate circuit) and the load (the resonant circuit).

With transformer loads as in methods 2 and 3, where mutual inductance ( $M$ ) provides the coupling between circuits, we can change the amount of coupling by changing the position of either  $L_1$  or  $L_2$ . When all of the flux produced by current flowing in the primary coil ( $L_1$ ) links with the sec-



ondary coil ( $L_2$ ), we have maximum coupling and maximum possible mutual inductance. When the primary and secondary coils are so positioned with relation to each other that only a part of the flux produced by one coil links with the other coil, the mutual inductance between them will be low and we have the condition of weak coupling. Under this condition the ratio of the actual mutual inductance to the maximum obtainable mutual inductance with very close coupling is a measure of the amount of coupling; this ratio is always a number less than 1, and is known as the *coefficient of coupling*. When two resonant tuning circuits are coupled, as in methods 3 and 4, the coefficient of coupling is quite important in determining the response characteristic of the circuit.

*Effect of Vacuum Tube Characteristics.* At the present time the use of pentode tubes in the R.F. amplifiers of radio receivers is becoming almost universal. Screen grid tubes are still to be found in some receivers, but triode tubes will be found only in the very old R.F. amplifier circuits. There are two features of pentode tubes which are significant in connection with tuning circuits and which should therefore be considered before we study coupling methods: 1, *pentode tubes have high A.C. plate resistance values*, because the plate is farther away from the cathode than in an ordinary triode tube; 2, *pentode tubes have high amplification factors*, because the control grid is considerably closer to the cathode than in an ordinary triode tube. For example, a 6K7 super-control pentode tube has an A.C. plate resistance of about 1,000,000 ohms and an amplification factor ( $\mu$ ) of about 1,000; a 6J7 pentode tube has an A.C. plate resistance greater than 1,500,000 ohms and a  $\mu$  of over 1,500.

In a practical modern R.F. amplifier the effective load resistance rarely

reaches a value higher than about one-tenth the A.C. plate resistance of the pentode tube. This condition corresponds to that of a generator which has an internal resistance of at least 1,000,000 ohms, connected to a load resistance of not more than 100,000 ohms; you can readily see that variations in the load resistance will have little effect upon the A.C. plate current. You could actually short out the load resistance without affecting the A.C. plate current more than 10%, since the resistance of the generator itself has the greatest amount of control over circuit current. Engineers say that under this condition we have a *constant-current generator*.

Because the A.C. plate resistance of a pentode tube in an R.F. amplifier stage of a receiver is extremely high with relation to its plate load resistance, we can consider a pentode tube as a *constant-current generator* for any given grid input signal voltage, and thus simplify greatly our study of resonant circuits. The constant-value A.C. plate current which the tube will deliver is easy to determine if the mutual conductance of the tube is known. Here is the rule: The A.C. plate current in microamperes in a pentode tube is equal to the *grid A.C. voltage in volts multiplied by the mutual conductance of the tube in micromhos*. Remember that with pentode tubes, whatever changes you make in the tuning circuit or circuits which serve as the load will have only negligible effect upon the A.C. plate currents.

The high amplification factor of a pentode tube produces a reasonably high output voltage despite the great loss in signal voltage due to the fact that the load resistance is less than the A.C. plate resistance.

*Importance of Studying Coupling Methods.* Now let us make a more detailed study of each of the basic coupling methods in order to see what the

engineer can do to secure the desired amount of selectivity, gain and fidelity for a particular purpose when designing radio apparatus using one of these circuits, and in order to see what the serviceman can do to alter the selectivity, gain or fidelity characteristics of a receiver. This discussion will show you the importance of making exact tube and parts replacements in R.F. circuits. Substituting some newly developed tube or part for older equipment may lead to serious trouble, unless the substitution is made with full knowledge

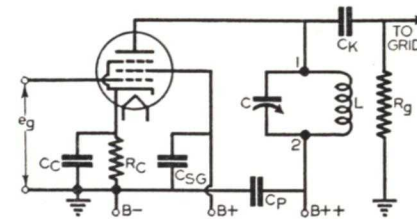

FIG. 6A. Directly coupled resonant load (a parallel resonant circuit whose terminals are 1 and 2) as commonly used in a pentode R.F. amplifier stage.

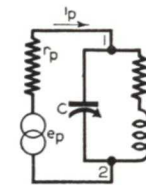

FIG. 6B. Simplified equivalent circuit of the directly coupled resonant load arrangement in Fig. 6A.

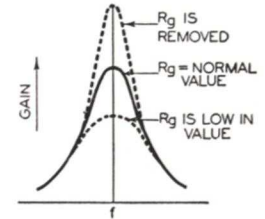

FIG. 7. Effects of grid resistor values upon the shape of the response curve for the circuit of Fig. 6A.

of the design problems involved in the change.

### Directly Coupled Resonant Loads

*Simplified Circuit.* We can simplify our study of the directly coupled parallel resonant load circuit in Fig. 6A by omitting all parts which have no effect upon the performance of the amplifying circuit and redrawing our circuit in the form shown in Fig. 6B. Observe that the R.F. by-pass condensers, the D.C. voltage supply leads for the tube electrodes and the automatic C bias resistor have been omitted, and the resistance of coil  $L$  is now represented by a separate resistor  $R$ . The vacuum tube has been replaced by an A.C. voltage source  $e_p$  (shown as an A.C. generator) in series with the A.C. plate resistance  $r_p$ , with the value of  $e_p$  being equal to the A.C.

*Effect of Coil Inductance and Q Factor on Over-all Amplification.* We know that the resonant resistance of the parallel resonant circuit in Fig. 6B depends upon the coil reactance and upon the Q factor of the coil; for any given frequency, then, increasing the inductance of the coil will increase its reactance, will increase the resonant load resistance, and will therefore increase the over-all amplification. Likewise, increasing the Q factor of the coil will increase the over-all amplification.

\*The voltage produced across the load for a one-volt grid input signal is a measure of the true amplification of a stage. In any pentode circuit such as we have here, we simply multiply the mutual conductance of the tube in micromhos by the resonant resistance of the load in ohms and divide the result by 1,000,000 to get the true or over-all amplification. Any change which increases the load resistance will therefore increase the over-all amplification.



For circuits which handle only a single frequency, such as I.F. amplifier stages, the designer endeavors to select a coil which has the highest usable inductance and at the same time has a high Q factor. From this it should be obvious to you that when a coil in the tuning circuit of an R.F. amplifier becomes defective, the mere substitution of another coil having the same inductance is not a guarantee that the correct over-all amplification will be obtained. The practical radio man uses exact duplicate replacement coils in order to make sure that he is using a coil with the correct Q factor as well as the correct inductance.

*Effect of Frequency upon Over-all Amplification.* Suppose we have a parallel resonant load circuit which tunes over the frequency range from 500 kc. to 1,500 kc.; will the over-all amplification remain the same at all frequencies in this range? Curve 2 in Fig. 5 shows that as frequency is increased above the middle-frequency range, the Q factor of a practical radio coil decreases: this reduction in Q factor would tend to reduce the over-all amplification at the higher frequencies. On the other hand, increasing the frequency three times (from 500 kc. to 1,500 kc.) would increase the reactance of the coil three times, thus increasing the resonant load resistance three times and consequently increasing the over-all amplification about three times. In most cases this increase in amplification due to an increase in coil reactance will completely overshadow the decrease due to a reduction in Q factor at high frequencies. Consequently we can say that increasing the signal frequency being fed to a tuned R.F. amplifier which uses a parallel resonant circuit as a plate load will in most cases increase the over-all amplification of the amplifier. Only when the Q factor drops rapidly with frequency, as in curve 1 in Fig. 5, will

the over-all gain remain constant or drop when frequency is increased.

*Effect of Frequency upon Selectivity.* The selectivity of an R.F. amplifier circuit is defined as the ratio of the amplification provided at the desired signal frequency to the amplification provided at the nearest undesired signal frequency. The effect of frequency upon selectivity can be demonstrated by considering an actual case, that where a broadcast band receiver using the circuit represented by Figs. 6A and 6B is first tuned to 500 kc. and then to 1,500 kc. For simplicity we will assume that in each case the nearest undesired frequency is 100 kc. away.

Remember that lowering the resonant resistance (or reactance if off resonance) of the tuned load circuit in this amplifier will lower the over-all amplification of the amplifier. Let us first assume that the Q factor remains constant over the range from 500 kc. to 1,500 kc.\* Under this condition we know that the amplification at resonance for 1,500 kc. will be three times the amplification for 500 kc.

At frequencies considerably off resonance, a parallel resonant circuit like that in Fig. 6B acts like that reactance (capacitive or inductive) which is lowest in ohmic value. At 400 kc. (100 kc. below the desired 500 kc. signal), then, the circuit will have a reactance essentially equal to the reactance of the coil, and this reactance will determine the amplification at this nearest undesired signal frequency in our example. Selectivity at 500 kc. will then be the ratio of the amplification at 500 kc. to the amplification at 400 kc. At 1,400 kc. (100 kc. below the desired 1,500 kc. signal), the reactance of the coil will be approximately three times its value at 400 kc. and there-

\*The Q factor of a practical coil actually varies considerably with frequency; a constant Q factor is assumed here in order to simplify this discussion.

fore the amplification at the nearest undesired signal in this case will be three times what it was for the nearest undesired signal in the previous case. Since the amplification at 1,500 kc. is likewise three times the value at 500 kc., we will get the same selectivity ratio in both cases. This means that *when the Q factor is assumed to be constant over the tuning range, the selectivity of a parallel resonant circuit will likewise remain essentially constant over the tuning range.*

With the coils generally used in the tuning circuits of radio receivers, however, the Q factor will be found to decrease considerably as frequency is increased. This decrease in Q factor lowers the amplification at resonance but has no effect upon amplification at off-resonance frequencies; consequently the selectivity ratios for higher frequencies will be reduced. In actual circuits the selectivity will vary in much the same manner as the Q factor of the coil varies; the curves in Fig. 5 thus can tell us how selectivity varies with frequency. In general, you will find it easier to separate stations in the middle region of a radio receiver tuning range than at the extreme high or low frequency ends, for coil Q factors are generally highest in the middle region.

*Effect of C Bias Voltage Variations.* It is a known fact that in super-control pentode tubes, increasing the negative C bias voltage has the effect of decreasing the mutual conductance of the tube, thereby lowering the A.C. plate current and reducing the over-all amplification of the stage. Variations in C bias voltage have little effect upon the selectivity of R.F. amplifiers using pentode tubes, however, for the resonant load characteristics are not affected by C bias voltage variations.

*Effect of Loading the Tuned Circuit.* There is one simple way of changing the selectivity and gain of a tuned cir-

cuit such as that shown in Fig. 6A, and this is to change the load on the tuned circuit by changing the value of grid resistor  $R_g$ . Obviously the gain will be lowered when the value of  $R_g$  is reduced, for this grid resistor acts in parallel with the resonant circuit and therefore reduces the load resistance in the plate circuit of the tube (assuming that coupling condenser  $C_K$  has negligible reactance). Off resonance, however, the value of  $R_g$  has little effect upon the amplification of undesired



All-wave superheterodyne receiver being aligned for peak response. An R.F. signal generator and an output meter are the only instruments needed. The output of the R.F. signal generator section is fed into the receiver, and the multimeter section is used as an output meter.

frequencies, for now the reactance of the tuned circuit will be considerably lower than the value of  $R_g$  ordinarily used, and the reactance of the tuned circuit will control amplification. Loading the tuned circuit of an R.F. amplifier by reducing the value of  $R_g$  thus lowers selectivity by lowering the amplification ratio for desired and undesired signals.

The effects of various values of  $R_g$  are shown graphically in Fig. 7; the middle response curve is for the condition where the usual fairly high value of  $R_g$  is in the circuit of Fig. 6A. The lower dotted curve is for a lower value of  $R_g$ , and clearly shows that both the



gain and the selectivity of a tuned circuit in an R.F. amplifier are lowered when the tuned circuit is loaded by reducing the ohmic value of the grid resistor for the following stage; fidelity is considerably improved, however, for the broad peak insures uniform amplification of all side frequencies. The uppermost dotted curve is for the condition where  $R_g$  is removed entirely; now amplification is very high and selectivity is good, but fidelity is very poor because side frequencies are amplified very much less than the carrier frequency. Thus you can see that the fidelity of a receiver using a tuning circuit like that in Fig. 6A could be improved by reducing the value of  $R_g$ , provided that a loss in amplification and selectivity is permissible. Likewise, DX (distance-getting) performance could be increased by using a higher value of  $R_g$ .

**High-gain Directly Coupled Resonant Load Circuit.** In some inexpensive receivers which have few tubes, the circuit in Fig. 6A is modified slightly to eliminate the amplification-reducing effect of  $R_g$ . Instead of coupling to the next tube through  $C_K$  and  $R_g$ , a second coil is inductively coupled to coil  $L$  and connected to the grid and cathode of the following tube. (The circuit arrangement is exactly as in Fig. 9A with tuning condenser  $C_2$  removed.) By using a large mutual inductance between the two similar coils, the entire resonant circuit voltage can be transferred to the following stage without appreciable loss. If there are more turns on the secondary than on the primary, a step-up in output voltage can be secured. Fidelity is somewhat poor with this arrangement, however, for a sharp peak response curve is secured. The peak can be broadened by shunting the tuning condenser ( $C$  in Fig. 6A with a 20,000 to 200,000 ohm resistor, but this will, of course, lower the gain.

### Tuned Secondary Transformer Loads

The R.F. amplifier circuit arrangement shown in Fig. 8A, which uses a tuned secondary transformer load, is widely used in tuned radio frequency receivers and in the station selector (preselector) circuits of superheterodyne receivers. Since it is modern practice to use pentode or screen grid tubes in this circuit also, the A.C. plate current will be essentially independent of conditions in the resonant load circuit; we will assume this condition during our discussion of this circuit.

A simplified version of the tuned secondary transformer load circuit in Fig. 8A appears in Fig. 8B. Observe

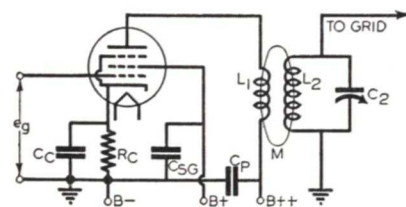

FIG. 8A. Tuned secondary transformer load circuit as commonly used in a pentode R.F. amplifier stage.

that the primary and secondary coils,  $L_1$  and  $L_2$ , are each divided into two parts in this equivalent circuit. Those sections on each coil which link each other completely through mutual inductance  $M$  provide the only coupling between the two circuits; the remaining sections, which do not link each other at all, are known as the primary and secondary leakage inductances respectively. The primary leakage inductance is always equal to the original primary inductance minus that inductance which totally links with the secondary coil, and this totally-linking portion is in turn equal to the primary inductance multiplied by the coefficient of coupling of the original circuit. This same reasoning also applies to the sections of the secondary inductance.

Resonance exists in the secondary circuit for a desired signal frequency when the reactance of tuning condenser  $C_2$  is equal to the reactance of the secondary leakage inductance at that frequency; the reactance of the other secondary coil section can be neglected, for it is cancelled out through mutual inductance  $M$  by the corresponding primary coil section. At resonance, then, the secondary resistance  $R_2$  is the only factor which limits secondary current. This secondary resistance has an effect upon the primary circuit; engineers say that it is reflected into the primary circuit, with the reflected value of resistance being determined by the value of mutual inductance  $M$ , by the signal frequency and by the original value of  $R_2$ . Increasing the mutual inductance, increasing the frequency or decreasing the ohmic value of  $R_2$  will increase the value of reflected resistance in the primary circuit.\* When the ohmic value of the reflected resistance equals the A.C. plate resistance of the tube, maximum gain is obtained in this tuned secondary transformer load circuit. It is almost impossible to secure this condition with screen grid and pentode tubes because of their high A.C. plate resistance values, but it can be done with triode tubes which have low A.C. plate resistance values.

In all practical circuits which use screen grid or pentode tubes, the reflected resistance in the primary circuit is negligibly small in comparison to the A.C. plate resistance of the tube. The primary signal current is therefore

\*Although undoubtedly you will never have to determine exactly what the reflected resistance value is, the formula for doing this is presented here for reference purposes: Multiplying the mutual reactance of  $M$  by itself once and then dividing by the secondary circuit resistance  $R_2$  gives the reflected resistance in the primary circuit. (Reflected resistance in ohms =  $2\pi fM \times 2\pi fM \div R_2$ , where  $\pi = 3.14$ ,  $f =$  frequency in cycles and  $M =$  mutual inductance in henrys.)

unaffected by any conditions in the secondary circuit which might change the value of reflected resistance. Furthermore, the reactance of the primary leakage inductance is also negligibly small in comparison to the A.C. plate resistance, and consequently the changes in this reactance with frequency can be neglected. Thus we find that the only two factors which control the A.C. plate current in a practical R.F. amplifier of the tuned secondary transformer load type are the mutual conductance of the tube and the applied A.C. grid voltage. The signal voltage  $e_s$ , which is induced in the secondary depends upon this A.C. plate current and mutual reactance of  $M$ .

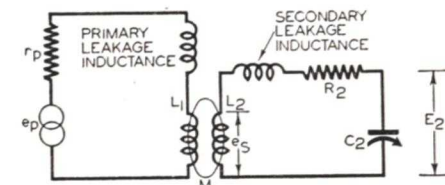

FIG. 8B. Simplified equivalent circuit of the tuned secondary transformer load circuit in Fig. 8A.

This means that desired as well as undesired signal voltages applied to the grid of the tube in Fig. 8A will produce the same induced voltage in the secondary circuit of the plate load; it remains for the series resonant secondary circuit to tune out all but the desired frequencies.

**Effect of Tuned Secondary Circuit on Amplification.** The voltage across secondary tuning condenser  $C_2$  in Fig. 8A is applied directly to the grid of the following tube, and therefore anything which increases the value of this voltage at resonance will make the over-all amplification of the stage greater. Since the tuned secondary is a series resonant circuit, this voltage is equal to the source voltage  $e_s$  multiplied by the Q factor of the secondary coil. Anything which increases the Q factor of the coil therefore increases



the over-all amplification. This is a good reason for using high Q coils in circuits of this type.

For a given grid input voltage, increasing the secondary induced voltage will also increase the over-all amplification of the stage; this can be done by using a tube which has a higher mutual conductance, by increasing the mutual inductance  $M$  between the primary and secondary, and by increasing the frequency of the desired signal.

To reduce the gain of an R.F. amplifier circuit like this, as is often necessary in actual receivers in order to prevent overloading of one or more following stages or to reduce the output volume to a desired lower level, the mutual conductance of the tube can be reduced. In a super-control pentode tube, the usual procedure for doing this involves increasing the negative C bias voltage on the tube.

When tuning the secondary circuit over a given frequency range, the amplification of the circuit will depend upon the manner in which the Q factor of the coil varies with frequency. Q factor normally decreases with frequency, but the reduction in gain due to this effect will be offset by an increase in gain due to the increased mutual reactance\* of  $M$  at higher frequencies; the result is that the amplification of a typical tuned secondary transformer load circuit varies slightly over its tuning range.

*Effect of Tuning Circuit on Selectivity.* If the Q factor of the coil in a tuned secondary transformer load circuit remained constant over a given frequency range, the selectivity would also remain constant; Q factor decreases at the higher frequencies, however, so selectivity will likewise decrease.

\*Mutual reactance equals mutual inductance times frequency in cycles per second times the number 6.28.

The peak of the response curve can be broadened or rounded by shunting the tuning condenser in Fig. 8A with a 20,000 to 100,000 ohm resistor. This will reduce the gain at resonance by reducing circuit current but will have little effect at off-resonance frequencies.

### Double-Tuned Transformer Loads

The double-tuned transformer load circuit shown in Fig. 9A is widely used in the I.F. stages of superheterodyne receivers. One advantage of this circuit is that it can provide high selectivity while keeping the number of tubes at a minimum; another advantage is that the circuit can be adjusted to give an almost flat-top response curve for high fidelity. We will consider first the adjustment of this circuit for peak response and for band-pass response, and will then analyze the factors which

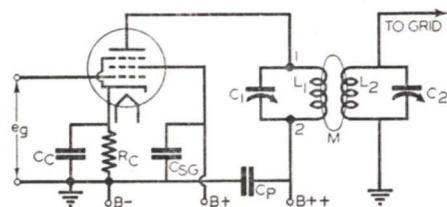

FIG. 9A. Double-tuned transformer load circuit as commonly used in a pentode R.F. amplifier stage.

control the circuit gain, selectivity and fidelity.

The circuit of Fig. 9A has been redrawn in simplified form in Fig. 9B in order that we can concentrate our study upon those parts which affect the performance of the tuned circuit. Again we have the coils divided into totally coupled sections and leakage inductance sections, as before.  $R_1$  represents the A.C. resistance of the primary coil, while  $R_2$  represents the A.C. resistance of the secondary coil.

*Adjusting for Peak Response.* With the circuit of Fig. 9B, a single-peak response characteristic can be obtained at any desired I.F. value by adjusting tuning condenser  $C_2$  until its reactance

exactly equals the secondary leakage reactance of the secondary winding at that I.F. value. Condenser  $C_1$  is then adjusted in the same way in order to tune the primary circuit to resonance at the desired I.F. value. In a practical case this adjustment is made by connecting an R.F. voltmeter across  $C_2$  to measure the secondary circuit output voltage  $E_2$ ;  $C_1$  and  $C_2$  are then adjusted for maximum voltmeter reading.

At resonance, there is only the secondary circuit resistance  $R_2$  to be reflected into the primary tuned circuit through mutual inductance  $M$ . This increases the resistance in the primary circuit, and therefore decreases the Q factor of the primary circuit. The presence of the secondary circuit thus reduces the voltage across primary tuning condenser  $C_1$ , thereby reducing the amount of resonant stepped-up current through coil  $L_1$  and reducing the amount of voltage induced in the secondary winding for resonance step-up by the secondary series resonant circuit. A double-tuned transformer load circuit which uses identical coils in both tuning circuits always gives less gain than a single parallel resonant load circuit using only one of these coils.

Increasing the mutual inductance  $M$  by increasing the coupling between primary and secondary coils tends to make the resistance which is reflected into the primary circuit larger, thus reducing  $E_1$ , but at the same time the increased mutual inductance serves to increase the voltage which is induced in the secondary. Since the two effects tend to offset each other, there is naturally a particular value of mutual inductance which will give the highest possible gain. By experiments as well as calculation, engineers have determined that this optimum condition occurs when the mutual inductance  $M$  is such that the resistance which is re-

flected into the primary circuit is exactly equal to the primary circuit resistance  $R_1$ .

In practical radio circuits, condensers  $C_1$  and  $C_2$  in Fig. 9A are usually of the same capacity, and consequently the primary and secondary coils must be alike in order to secure resonance at the same frequency. Since double-tuned transformer load circuits are ordinarily found in I.F. amplifier stages, these condensers will be of the trimmer type, independently adjustable. With any given coils, the condenser settings required for resonance are definitely fixed, and only the coupling between coils can be varied in

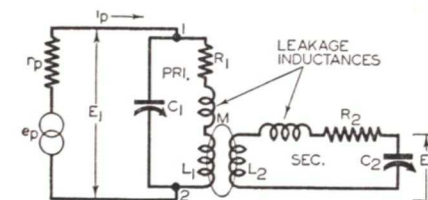

FIG. 9B. Simplified equivalent circuit of the double-tuned transformer load circuit in Fig. 9A.

order to secure optimum conditions. That coupling which gives the maximum possible gain is called the optimum or critical coupling. With identical coils, optimum coupling is obtained when the coefficient of coupling is exactly equal to 1 divided by the Q factor of the coil. For example, if the coil has a Q factor of 100, the coefficient of coupling for optimum gain will be  $1 \div 100$ , or .01.

Once a double-tuned transformer load circuit is adjusted for optimum coupling, either increasing or decreasing the coupling from this value will reduce the over-all gain. Increasing the coefficient of coupling also reduces the selectivity, broadening the peak of the response curve because of the increase in the resistance reflected into the primary circuit, but decreasing the coupling serves to increase the selectivity. When double-tuned transformer load



circuits are used to give a single-peak response, the coupling is kept less than the critical value (the coils are under-coupled) in order to improve the selectivity at a sacrifice of gain.

*Adjusting for Double-Peak Response.* Let us assume first that there is no coupling whatsoever between the secondary circuit and the primary circuit, both being tuned to the frequency of the source. Clearly there will be no voltage induced in the secondary coil under this condition, and consequently there will be no output voltage. Now as we bring the secondary coil closer to the primary coil, energy will be transferred through the mutual inductance

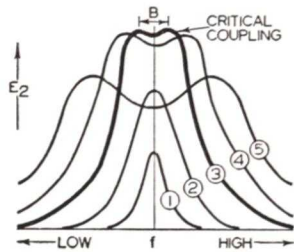

FIG. 10. Effect of variations in coupling upon the shape of the response curve for the double-tuned transformer load circuit in Fig. 9A.

between the two coils and an output voltage will be produced across  $C_2$ . As we gradually increase the coupling up to the critical coupling value, this output voltage will continue to increase. Increasing the coupling beyond the critical value will at first have no effect upon the output voltage and will then gradually cause the output voltage to lower. What actually happens is shown in Fig. 10; curve 1 represents a very small amount of coupling, while curves 2, 3, 4 and 5 represent increasing greater amounts of couplings, with curve 3 representing the conditions for critical coupling.

Let us see why double peaks occur in curves 4 and 5 in Fig. 10. When coupling is below the critical value,

both primary and secondary circuits have the same resonant frequency (assuming correct tuning) and single-peak response is secured. Increasing the coupling beyond the critical value without changing the tuning condenser settings causes the leakage inductance in each circuit to decrease, and consequently the resonant frequency of the secondary circuit becomes higher than before (the lower the effective inductance for a given capacity value, the higher is the resonant frequency of a resonant circuit). Increasing the coupling beyond the critical value likewise lowers the primary leakage inductance, making the primary circuit resonate also at a higher frequency. A signal at this higher frequency will thus undergo resonant step-up in both the primary and secondary circuits, giving a high output voltage.

When we exceed the critical coupling value, we have another interaction between the two circuits to consider. Consider conditions for a signal which is lower than the original resonant frequency of the secondary. At this lower frequency the series resonant secondary circuit will act as a capacity and will reflect into the primary circuit as an inductance which increases the effective primary inductance, bringing the primary circuit to resonance at this lower frequency. Likewise, the parallel resonant primary circuit alone will act as an inductance at the lower frequency and will reflect into the secondary as a capacity which brings the secondary to resonance at the lower frequency also. Primary and secondary circuits are thus resonant to both a higher and a lower frequency than the resonant frequency of either circuit alone, and as a result we have double-peak or band-pass response.

At critical coupling, an essentially flat-top response curve is obtained, with fairly steep sides and double peaks just beginning to form. The ap-

## RESONANT CIRCUIT DATA

At frequencies below the resonant frequency:

- A series resonant circuit acts as a capacity.
- A parallel resonant circuit acts as an inductance.

At frequencies above the resonant frequency:

- A series resonant circuit acts as an inductance.
- A parallel resonant circuit acts as a capacity.

General rule: At any off-resonant frequency, a series resonant circuit acts like that part which has the highest reactance, while a parallel resonant circuit acts like that part which has the lowest reactance.

proximate distance between these peaks, as measured in kc., is easily computed; it is equal to the coefficient of coupling multiplied by the carrier frequency to which the R.F. amplifier is tuned. For example, suppose that the coils in Fig. 9A each have a Q factor of 150, and the two resonant circuits are tuned to 460 kc. Critical coupling will be obtained when the coefficient of coupling is 1 divided by 150, which equals .0067; the separation between peaks at this condition of critical coupling will then be equal to 460 (the frequency in kc.) multiplied by .0067, or about 3 kc. The actual practical band width for this particular case will be somewhat wider (about 4.5 kc. in this example), for it is determined by the distance between the steep sides of the response curve rather than by the distance between the peaks.

In the above example, we can triple the amount of separation between peaks (thereby tripling the bandwidth) by tripling the amount of coupling, but this will give a valley between peaks as in curves 4 and 5 in Fig. 10. If, in addition to tripling the coupling, we reduce the Q factors of the coils to one-third of their original values, we can secure this same tripling of bandwidth without having a valley between peaks, but the gain will be considerably less when this is done. Clearly we

must sacrifice one advantage in order to secure another, in this particular case.

When an engineer designs band-pass circuits like that in Fig. 9A, he endeavors to choose coils which will give the desired band-width at critical

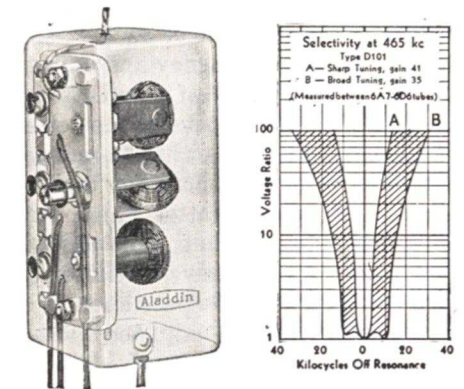

Courtesy Aladdin Radio Industries, Inc.

This Aladdin type D I.F. transformer provides any desired performance characteristics from high fidelity to extreme selectivity without appreciable variation in gain, at the option of the user. Rotating the center coil by means of a knob on the front panel of the receiver serves to vary the coupling between the other two coils. In the under-coupled position, as represented by curve A, we have sharp tuning and severe cutting of side frequencies above about 4,000 cycles, while curve B corresponds to over-coupling, with practically uniform amplification of all side frequencies up to 10,000 cycles off resonance. Three built-in trimmer condensers, one for tuning each coil, give additional control over transformer characteristics.

coupling. If he finds that this is impossible, he increases the coupling beyond the critical value enough to secure the desired band-width. This gives somewhat lower gain (curve 5 in



Fig. 10 represents lower gain than curves 3 and 4).

**Adjusting Actual Band-Pass Circuits.** Band-pass circuits in practical radio frequency amplifiers are easily adjusted with the aid of a cathode ray oscilloscope which is connected to reproduce the response curve of the amplifier. By watching the effects of each adjustment upon the shape of this response curve, the radio serviceman knows definitely when he has secured the desired shape.

Ordinarily a serviceman does not know whether a particular band-pass circuit is over-coupled (greater than critical coupling), or is under-coupled (less than critical coupling). For this reason he must always try to adjust the circuit for peak response before making band-pass adjustments. In the case of Fig. 9A, this is done simply by feeding into the amplifier an R.F. signal of a definite frequency and adjusting tuning condensers  $C_1$  and  $C_2$  for maximum output voltage at the detector load, as indicated either by an output meter or by a cathode ray oscilloscope. It does not matter which condenser is adjusted first. The adjustments are repeated several times. If there are several band-pass circuits in an amplifier, each is adjusted in this same way for peak response. Inability to secure a single-peak response when this is done means that the coils are over-coupled; in this case the preliminary adjustment is omitted.

A cathode ray oscilloscope and a variable frequency signal generator are now connected to the amplifier in the proper manner to produce on the cathode ray oscilloscope screen the actual response curve of the entire amplifier. Assuming that the circuit in Fig. 9A is the only band-pass circuit in the amplifier, the capacity of  $C_1$  is increased slightly and the capacity of  $C_2$  is decreased the same amount (or  $C_1$  may be decreased and  $C_2$  increased) to

make the flat top appear. If the coils have approximately critical coupling, only small changes in the condenser settings will be needed to secure double peaks. When coupling is considerably less than the critical value, however, the two condensers may have to be changed considerably from their peak response settings before the two peaks will appear. If the coils in a double-

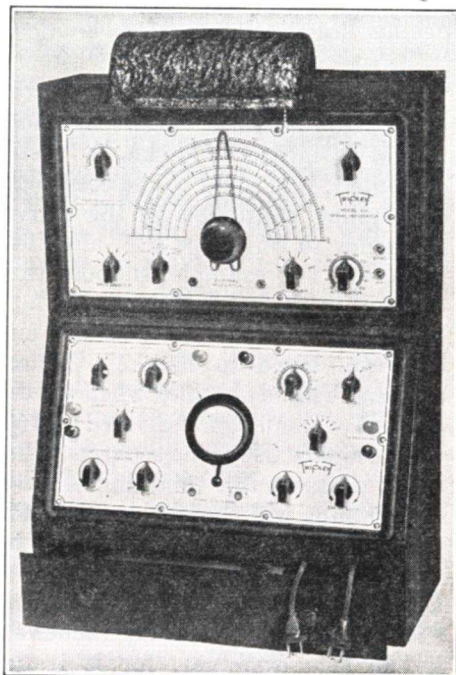

Courtesy Triplett Electrical Instrument Co.

A cathode ray oscilloscope (lower section) and a frequency-modulated signal generator (upper section) are here mounted in a single cabinet. They can be connected to a radio receiver in a few minutes for producing the response curve of the receiver, and have a host of other radio servicing and testing uses as well.

tuned circuit are over-coupled, it will be impossible to adjust for a single-peak response; the two peaks will always be present, and changes in condenser settings will merely serve to change the distance between peaks and alter the symmetry of appearance.

The more the condenser settings are changed, the greater will be the distance between the two peaks and the deeper will be the valley between the peaks. If the peaks of the response

curve of a double-tuned circuit are excessively high with respect to the valley between them when the desired band-width is secured, they can be reduced by shunting the primary and secondary circuit tuning condensers with 20,000 to 100,000-ohm resistors. This actually pulls the two peaks closer to the level of the valley, thus making the response more uniform over the entire band-width. It may be necessary to experiment with different values of resistors in the primary and secondary circuits in order to reduce both peaks equal amounts, if condenser adjustments alone are not sufficient to give a symmetrical response curve.

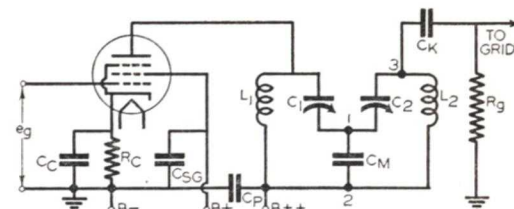

FIG. 11A. Double-tuned capacity-coupled load circuit commonly used in a pentode R.F. amplifier stage.

## Double-Tuned Capacity-Coupled Loads

Two resonant circuits may be coupled together by capacity coupling, as illustrated in Fig. 11A, instead of inductive coupling. Circuit action is much the same with either type of coupling, so there should be no difficulty in understanding how the simplified version of this capacity-coupled arrangement, shown in Fig. 11B, behaves under various operating conditions.

When both tuned circuits are at resonance, the secondary tuned circuit made up of  $L_2$ ,  $C_2$  and  $C_M$  will act as a resistance. If we measure the resonant resistance between points 2 and 3, in

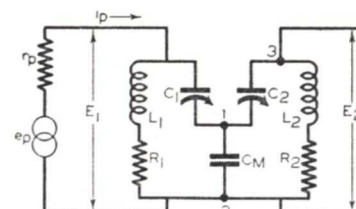

FIG. 11B. Simplified equivalent circuit of the double-tuned capacity-coupled load circuit in Fig. 11A.

In many modern high-fidelity receivers, controls are provided which vary the coupling between the primary and secondary coils of one or more double-tuned transformer load circuits in order to permit a choice between peak response and band-pass response. These transformers will have critical coupling when this control is set for band-pass performance. In some circuits which use variable coupling, you may find that the variable coupling control is labeled "volume control" on the schematic circuit diagram and on the panel of the receiver. In this case the coupling will always be less than the critical value, and under this condition any changes in coupling will affect the receiver gain far more than it will the receiver selectivity. We thus have simply a unique volume control.

the circuit of Fig. 11A, we find it to be quite high.

You will note that tuning condenser  $C_2$  and coupling condenser  $C_M$  are in series between points 2 and 3. A part of the total high resistance between these points will therefore exist across the terminals of coupling condenser  $C_M$ , and experience has shown that the actual value of this resistance will be proportional to the reactance of  $C_M$ . Increasing the reactance of coupling condenser  $C_M$  will therefore increase the effective resistance across it and thereby increase the resistance which is reflected into the primary circuit.

At resonance, the resonant resistance of the primary tuning circuit made up of  $L_1$ ,  $C_1$  and  $C_M$  determines the value of the signal voltage  $E_1$  which will be produced across the primary coil.



Again we assume that the pentode tube maintains the plate current  $i_p$  essentially constant; the resonant circuit current through the primary coil is of course greater than  $i_p$  and varies in value as circuit conditions are changed. The greater the resistance reflected into the primary circuit by the secondary, the lower will be the resonant circuit current through the primary coil and the lower will be the voltage across the primary. Just as with inductive coupling, maximum secondary circuit output voltage is obtained with critical coupling between the primary and the secondary, under which condition the resistance reflected into the primary is equal to the primary circuit resistance  $R_1$ . When  $C_1$  is equal to  $C_2$ , as is usually the case in a practical circuit, the coefficient of coupling is the ratio of  $C_1$  to  $C_M$ .

Just as with other band-pass circuits, increasing the coefficient of coupling beyond the critical value results in a double-peak response curve. The reasons for the existence of a double peak under these conditions are quite easily understood. When the capacity of coupling condenser  $C_M$  is made lower than the critical value, thereby raising its reactance, raising the voltage developed across it for transfer from primary to secondary, and increasing the coupling, the combined capacity of condensers  $C_2$  and  $C_M$  in series will be less than before, making the resonant frequency of the secondary higher than before. Likewise the lower capacity of  $C_M$  in series with  $C_1$  will raise the resonant frequency of the primary to the same high value. We have thus accounted for the higher-frequency peak on the band-pass response curve.

Now consider the effects of interaction between the two tuned circuits when the coefficient of coupling is beyond the critical value and the incoming signal is below the resonant frequency. Looking at the primary cir-

cuit first, we note that secondary circuit components  $L_2$  and  $C_2$  in series are shunted across  $C_M$ ; the reactance of  $C_2$  being greater than that of  $L_2$ , this shunt combination will act as a condenser in parallel with  $C_M$ , increasing the effective capacity of  $C_M$  in the primary circuit. This higher value of  $C_M$  acting in series with  $C_1$  increases the effective capacity in the primary circuit and therefore causes the primary

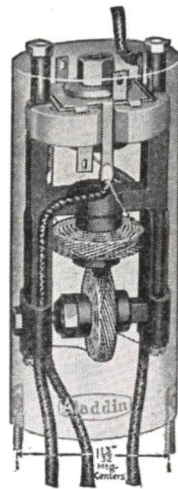

Courtesy Aladdin Radio Industries, Inc.

Here is an adjustable coupling I.F. transformer (Type A Aladdin Polyiron transformer) which you may encounter in high quality radio receivers and particularly in commercial receivers. The curves at the right show its performance at different degrees of coupling. Note that the coils are at right angles to each other; moving the lower coil in either direction along its shaft by means of adjusting screws changes the coupling. Critical or optimum coupling is secured when the lower coil is not directly under the upper coil; curve B represents this condition, giving the ratio of the voltage output at resonance to the voltage output at frequencies up to 40 kc. above and below resonance. Amplification at the resonant frequency (465 kc.) is 250 for this condition, an unusually high value. Moving the coil more nearly under the upper coil gives under-coupling, with reduced gain but improved selectivity, as indicated by curve A. Moving the lower coil out from the critical coupling position gives over-coupling, with double peak response for high-fidelity band-pass results.

circuit to resonate at a lower frequency than the original value. Exactly the same analysis will show that the secondary circuit will also resonate at this lower frequency. Thus we have accounted for the lower-than-normal peak in the band-pass response curve

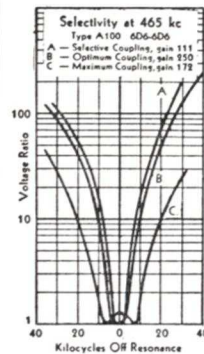

The reason why double peaks are not secured when the coefficient of coupling is less than the critical value is quite simple. Under this condition the capacity of  $C_M$  is so high that interaction between the two circuits is negligible. As a result, each circuit resonates at only one frequency, and a single peak response curve is secured.

With capacitive coupling between two resonant circuits, the separation between peaks at critical coupling is equal to the operating frequency multiplied by the coefficient of coupling, just as in the case of inductive coupling. Increasing the Q factor of the coils in the circuit of Fig. 11A increases the value of coupling required for critical coupling, thereby lessening the separation between peaks at critical coupling, but higher gain is secured. Increasing the coupling (by reducing the capacity of  $C_M$ ) increases the separation between peaks and therefore increases the band-width.

Just as with any double-tuned circuit, the separation between the two peaks may be increased, giving greater band-width, by detuning the primary and secondary circuits (by increasing the capacity in one circuit and decreasing the capacity an equal amount in the other). This deepens the valley between the peaks, but loading of the primary and secondary circuits with resistors will flatten the peaks and give a more uniform response curve over the entire band-width.

The procedure just described for widening the band-width and loading the tuning circuit is commonly used in the tuned circuits of television receivers, where a band-width of the order of 6 megacycles (6,000,000 cycles) is generally required. This procedure reduces the gain considerably, and consequently television receivers require more amplifier stages than broadcast band receivers. Both

capacitive and inductive coupling are used in the double-tuned circuits of television receivers.

## Combination Capacitive and Inductive Coupling

In tuned circuits which are to operate over a definite range of radio frequencies, such as the preselector circuits in superheterodyne receivers, the amount of coupling between tuned circuits is not entirely independent of frequency. As a result, the response curve of the circuit will vary in shape and

Fixed mica condensers are permanently connected across the coils in this type L inductance-tuned Aladdin I.F. transformer. Tuning is accomplished by changing the positions of the Polyiron pulverized iron cores inside each coil; this is done by adjusting the set screws at the top, labeled PRI. and SEC. Coupling is always less than the critical value. A gain of about 100 is secured when the coils are adjusted for peak response.

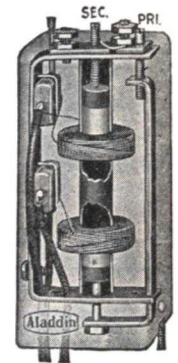

Courtesy Aladdin Radio Industries, Inc.

size at different frequencies, with the nature of the variation being dependent upon the type of coupling used.

Consider the double-tuned transformer load circuit in Fig. 9A first. Assuming that the coil Q factors remain the same as we tune from a low to a high radio frequency, we see that the reactance of mutual inductance  $M$  increases with frequency, producing a greater induced voltage in the secondary circuit and therefore giving a greater gain at the higher frequencies.

With the capacity-coupled circuit shown in Fig. 11A, on the other hand, the reactance of coupling condenser  $C_M$  decreases as we tune from a low to a high frequency, with the result that less voltage is fed into the secondary tuned circuit at higher frequencies, and



less gain is realized at higher frequencies.

Capacitive and inductive coupling are often used in the same circuit in order to make an amplifier have the same gain at both low and high frequencies. A typical band-pass R.F. amplifier circuit which uses both types of coupling is given in Fig. 12; as you can see, primary coil  $L_1$  is inductively coupled (through mutual inductance  $M$ ) to secondary coil  $L_2$ , and these two coils are also coupled together capacitively by coupling condenser  $C_M$ . The antenna is inductively coupled to coil  $L_1$  in the first tuned circuit through mutual inductance  $M_A$ . Resistor  $R_g$ , having a high ohmic value, provides

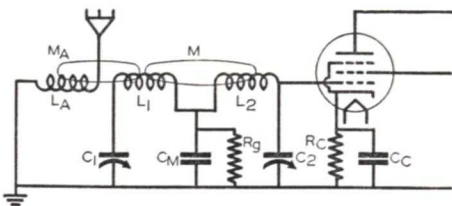

FIG. 12. Double-tuned R.F. amplifier input circuit using both inductive ( $M$ ) and capacitive ( $C_M$ ) coupling to equalize the gain at all frequencies in the tuning range.

a conductive path around coupling condenser  $C_M$ , so that the negative C bias voltage across  $R_C$  and  $C_C$  will be applied to the grid of the tube.

### Tuned Secondary with Fixed Tuned Primary Circuit

When a single resonant circuit gives more gain at high frequencies than at low frequencies, the circuit illustrated in Fig. 13 is often used to equalize the gain over the entire tuning range. The primary winding  $L_1$  has a distributed capacity between turns which is in effect equivalent to a condenser  $C_1$  connected across the winding. The primary coil can be so designed that the coil and its distributed capacity form a parallel resonant circuit which reso-

nates at a low frequency in the tuning range, giving resonant current step-up at low frequencies and thereby inducing larger voltages than normal in the secondary circuit at the lower frequencies in the tuning range. At the higher frequencies, however, the primary circuit is off resonance and the value of mutual inductance  $M$  alone determines the amount of voltage induced in the secondary.

Unfortunately, this use of a fixed tuned primary circuit to boost the gain at low frequencies works entirely too well, boosting the gain at low frequencies so much that we have the reverse of the initial unequal gain condition. It is for this reason that a small amount

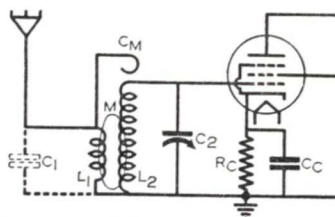
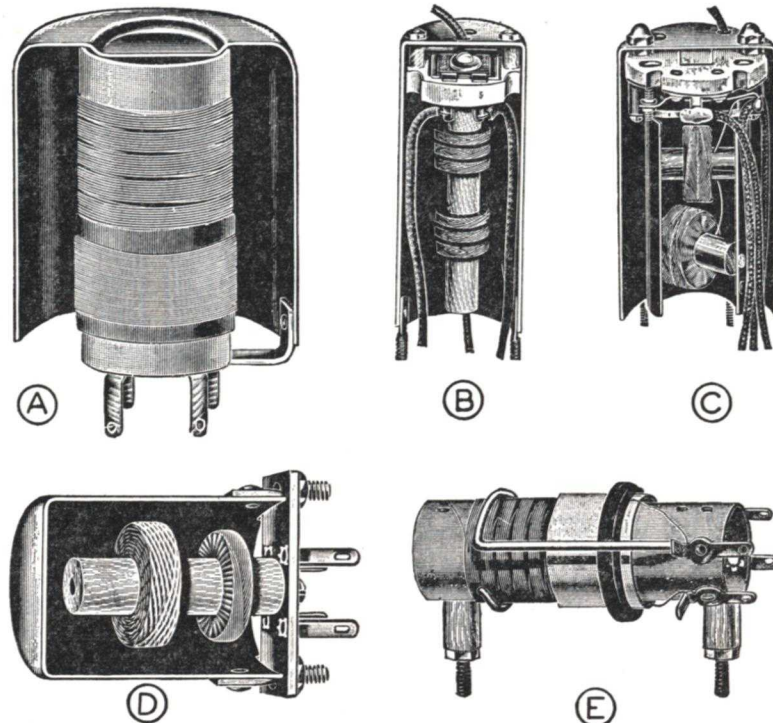

FIG. 13. Another R.F. amplifier input circuit which uses both inductive and capacitive coupling to equalize the gain over the tuning range. Fixed tuning of the primary coil is provided by the distributed capacity ( $C_1$ ) between turns of the coil.

of capacity coupling is used between the high R.F. terminal of the primary coil and the high R.F. or grid terminal of the secondary coil; a stiff copper wire connected to the primary and curled partly around the secondary winding at the grid terminal end provides sufficient capacity coupling for the purpose. This wire does not connect to the secondary coil, as only capacity coupling is desired.

The circuit diagram in Fig. 13 illustrates the use of this capacity-coupling wire in the antenna system of a receiver. Antenna coil  $L_1$ , along with its distributed capacity, tunes to about the lowest frequency in the tuning range of the secondary circuit (this tuning range being controlled by  $L_2$



Typical R.F. transformers which can be used in the tuning circuits described in this lesson. Getting the required inductance is only a small part of the coil designer's work; he must also consider such important things as the Q factor and how it varies with frequency, the degree of coupling needed for desired results, effect of the shield, and gain-equalizing methods. The examples shown here are all Gen-Ral coils, made by General Mfg. Co.

A—Shielded R.F. transformer having a bank-wound secondary made of litz wire, with an ordinary single-layer primary wound over the lower end of the secondary. With the average pentode tube this transformer gives a gain of 42 at 550 kc. and a gain of 62 at 1,500 kc.; this nearly uniform gain over the tuning range is secured by proper design of the secondary coil. You will find this coil used in circuits like the tuned secondary transformer load arrangement of Fig. 8A.

B—Shielded I.F. transformer. Triple-section cross-wound primary and secondary coils are used to give a high Q factor. The coupling (spacing between coils) is adjusted during manufacture for optimum results. Tuning condensers are built into the housing, one being connected across

and  $C_2$ ). A stiff wire attached to the antenna post (the high R.F. terminal) of primary coil  $L_1$  loops around the grid end of secondary coil  $L_2$ . This arrangement gives practically uniform gain over the entire tuning range. You will find this stiff wire scheme used for

each coil. Look for units like this in double-tuned transformer load circuits such as that in Fig. 9A.

C—Shielded I.F. transformer. The cross-wound coils are made with litz wire and are weakly coupled (coefficient of coupling is less than the critical value) to give sharp peak response. Also used in circuits like Fig. 9A.

D—Shielded R.F. transformer having cross-wound primary and secondary coils mounted permanently on a wood dowel; coupling cannot be adjusted. This construction gives fair gain, but this varies considerably over the tuning range. Used in circuits like Fig. 8A.

E—Unshielded antenna coil for broadcast band. Secondary is made of litz wire, bank-wound directly on coil form, while the lattice or cross-wound primary is located over one end of the secondary. The primary is self-tuned (by its distributed capacity) to about 550 kc., and a heavy-wire coupling ring provides capacity coupling between primary and secondary, so that the gain is very nearly uniform throughout the broadcast band. Fig. 13 illustrates how the coil is used.

capacity coupling between coils in practically all of the small universal A.C.-D.C. tuned radio frequency receivers. (In some receivers this stiff wire is replaced by several turns of insulated wire or by two short insulated leads twisted together.)



## R.F. Tuning Circuits Used in Actual Receivers

Although the R.F. tuning circuit diagrams already presented in this lesson are typical of those used in most radio receivers, there are a number of minor variations of these circuits which will occasionally be encountered. Three different receivers which use out-of-the-ordinary R.F. tuning circuits have been selected for study. The circuit diagrams of the R.F. sections of these sets are shown in much the same way as they appear in the re-

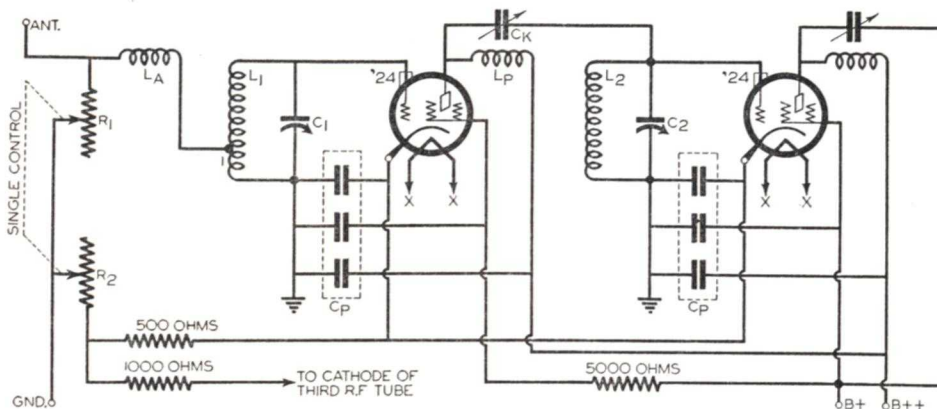

FIG. 14. A portion of the circuit diagram of the General Motors model MA T.R.F. receiver, illustrating an interesting method used to equalize the gain over the entire tuning range.

spective service manuals, in order to make you familiar with the different drawing techniques used in actual practice.

*General Motors Model MA T.R.F. Receiver.* The first two stages of this receiver are shown in Fig. 14; in the actual receiver there are three R.F. stages, giving four tuned circuits which can be tuned over the 550 kc. to 1,500 kc. broadcast band by a single tuning control. Observe that type 24 screen grid tubes are used; since these have very high A.C. plate resistance values, their A.C. plate currents can be considered essentially constant under all circuit conditions. This receiver clear-

ly does not have A.V.C.; the volume is controlled by a dual rheostat which simultaneously varies the resistance across the antenna input coil (this is done by  $R_1$ ) and varies the C bias voltage on the R.F. tubes (this is done by  $R_2$ ). The cathode, screen grid and plate by-pass condensers for each tube are mounted in a single case (indicated by dotted lines and labeled  $C_p$ ).

You will readily recognize  $L_1-C_1$  as the first tuning circuit, this being fed with the antenna signal by a direct connection from the antenna to a tap

at point 1 on  $L_1$ . But notice that the antenna signal must first pass through coil  $L_A$ , which is *not* inductively coupled to  $L_1$ ; we suspect immediately that this is used by the designer to equalize the gain over the tuning range. Coil  $L_A$  actually serves to tune the antenna at the low frequency end of the tuning range, reducing the antenna impedance to a minimum value and thereby causing a large signal current to flow into the portion of coil  $L_1$  between point 1 and ground. At the higher frequencies in the range, the antenna is off tune, antenna current is lower and the gain of the input tuning circuit is consequently lower also. Thus coil  $L_A$  can

counteract a tendency for tuning circuit  $L_1-C_1$  (or any other tuning circuit in the receiver) to give higher gain at the higher frequencies.

Now let us analyze the second tuning circuit, made up of  $L_2-C_2$ . The voltage developed across R.F. choke  $L_p$  by the flow of A.C. plate current through this high-impedance choke is applied to this second tuning circuit through coupling condenser  $C_k$ . Coil  $L_p$  has a certain amount of distributed capacity which tunes it to resonance at a low frequency in the tuning range, thereby raising its impedance at low frequencies and increasing the signal voltage which it can deliver to the second tuning circuit.

Since the reactance of coupling condenser  $C_k$  decreases at the higher frequencies, this condenser will transfer more voltage at the higher frequencies. Coil  $L_p$  thus serves to raise the gain at low frequencies, while  $C_k$  raises the gain at high frequencies; observe that  $C_k$  is adjustable so that any amount of equalization of gain over the tuning range can be attained. This condenser need be adjusted only as a part of the regular alignment procedure for the receiver.

*General Electric Model F-107 Super-heterodyne Receiver.* You know that the higher the coil Q factor in a tuning circuit, the higher is the gain and the selectivity of the circuit. Sometimes, however, the circuit designer runs into a condition where he has exactly the desired selectivity but has too much gain. To reduce this gain in order to prevent overloading, he could use shunt resistors across tuning condensers, but this would also reduce selectivity and would therefore be undesirable. One designer solved this problem by choosing R.F. coils which gave the desired selectivity, then tapping one of the coils to remove only a fraction of the total available voltage.

The result is the I.F. amplifier section illustrated in Fig. 15, where the tap at point 1 allows only about 60% of the total available voltage in this tuning circuit to be impressed upon the grid of the second I.F. tube. If necessary, an even greater reduction in gain could be secured by using a similar tap for the plate connection on the primary winding of this I.F. transformer.

*RCA-Victor Model 5M Auto Radio Receiver.* An antenna input coupling circuit which is widely used in auto radios is shown in Fig. 16. The filter circuit made up of  $C_1$ ,  $L_1$  and  $C_2$  is known as a low-pass filter and is used

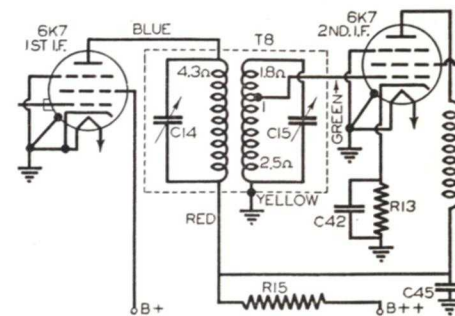

FIG. 15. Here is one I.F. stage of the model F-107 General Electric receiver, an example of a fixed frequency amplifier. This circuit diagram (taken from the service manual for the set) tells how the I.F. transformer leads in this receiver can be identified by their color. Note that the D.C. resistance of each coil is indicated, for continuity testing purposes.

to allow only R.F. signals which are below 1,500 kc. to pass. This is highly important in an auto radio receiver, for the spark coil type ignition systems used in automobiles develop ultra-high frequency radio waves which can create interfering signals if they enter the input circuit of the radio receiver. R.F. signals in the desired frequency range pass through this filter without appreciable opposition and develop a signal voltage across input coil  $L_2$ . This signal voltage is in turn fed through coupling condenser  $C_3$  into the first resonant circuit, the coupling being through that section of coil  $L_3$  which is below point 1 and then through condenser  $C_6$  to ground. As a result there



is both inductive and capacitive coupling, giving equalization of gain over the entire tuning range. Tuning condenser  $C_5$  tunes the portion of  $L_3$  between point 1 and the grid of the first tube over the entire tuning range;  $C_4$  is simply a trimmer condenser used for alignment purposes. The three vertical lines and one diagonal line above coil  $L_3$  symbolically indicate that the coil uses a pulverized iron core, with the diagonal line indicating that the position of the core and therefore the inductance are adjustable. This core thus provides an aligning adjustment at the low frequency end of the tuning

to equalize the gain; in a circuit of this type, we are safe in assuming that the primary will tune to a lower frequency in the range to counteract increasing gain provided by the secondary circuit at the higher frequencies. The low resistance of the secondary coil indicates that this coil has a high Q factor.

*Conclusion.* I do not expect you to be able to analyze in a few minutes any R.F. tuning circuit which you may encounter after your study of this lesson, for there apparently is no limit to the number of variations which are being used by circuit designers. I do say, however, that after you have studied a

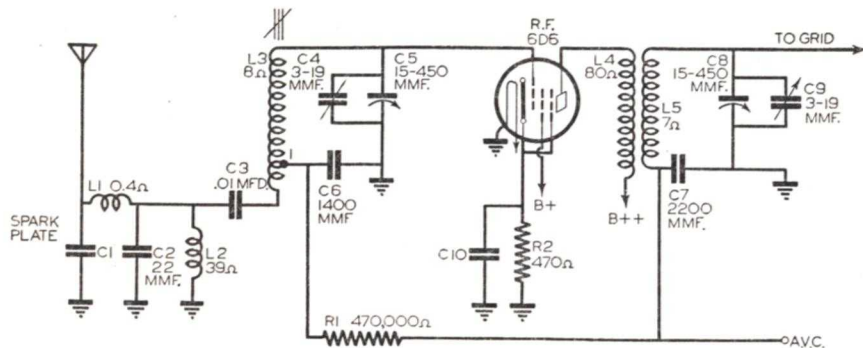

FIG. 16. Input circuits of the model 5M RCA Victor Auto Radio. Condenser  $C_1$ , labeled SPARK PLATE, provides a shunt path to ground for high-frequency interference signals produced by the spark plugs and ignition system of the automobile.

range, while high frequency trimmer  $C_4$  permits alignment at the high frequency end of the range.

Turning now to the plate circuit of the first tube, you might say at first glance that this contained a conventional tuned secondary transformer load. Closer examination would show, however, that while the D.C. resistance of the primary coil was 80 ohms, the secondary coil had a D.C. resistance of only 7 ohms. These figures tell us that the primary coil must be made of many turns of fine wire and hence must have a high inductance and high distributed capacity. This distributed capacity tunes the primary to some frequency in the tuning range in order

number of other schematic circuit diagrams in the same way as we have analyzed the three diagrams at the end of this lesson and after you have acquired practical experience with the behavior of tuning circuits in actual radio receivers, you will find yourself in a far better position to service radio receivers and know what to expect from them than if you simply made adjustments blindly without knowing exactly what you were doing. You will know *why* certain things happen when certain screws and knobs are turned in a receiver, and will be able to determine whether or not the fidelity or selectivity of a particular receiver can be improved.

## Lesson Questions

Be sure to number your Answer Sheet 22FR-2.

Place your Student Number on every Answer Sheet.

Never hold up one set of lesson answers until you have another ready to send in. Send each lesson in by itself before you start on the next lesson. In this way we will be able to work together much more closely, you'll get more out of your Course, and you will receive the best possible lesson service.

1. What does a sharp peak response curve for an R.F. amplifier indicate as regards gain and selectivity? *DISTORTION*
2. Will an R.F. amplifier which has a sharp peak response curve cause severe attenuation of the higher modulation frequencies? *YES*
3. Will amplitude distortion occur when an R.F. amplifier has a symmetrical double-peak response curve? *NO*
4. How is a high Q factor obtained for a coil which has a given inductance? *KEEPING THE LOSSES AT A MINIMUM. DUE TO CAPACITY BETWEEN TURNS OF A COIL.*
5. Does the Q factor of a practical coil vary with frequency? *YES*

6. Why can a pentode tube in the R.F. amplifier stage of a receiver be considered as a constant-current generator? *BECAUSE THE A.C. PLATE RESISTANCE OF A PENTODE IN AN R.F. AMPLIFIER OF A RECEIVER IS EXTREMELY HIGH WITH RELATION TO ITS PLATE LOAD.*
7. What effect does the loading of a tuned circuit in an R.F. amplifier have upon its selectivity and gain? *LOWERS THE SELECTIVITY*
8. Name two advantages which are secured by using a double-tuned transformer load circuit. *PROVIDE HIGH SELECTIVITY - 2. THE CIRCUIT CAN BE ADJUSTED TO GIVE HIGH FIDELITY*
9. Is it possible to adjust the trimmer condensers for a single-peak response when the two coils in a double-tuned circuit are over-coupled? *IT WILL BE IMPOSSIBLE TO ADJUST FOR A SINGLE PEAK RESPONSE.*
10. If the peaks in the response curve of a double-tuned circuit are excessively high with respect to the valley between them, how can they be reduced without changing the band width? *BY SHUNTING THE PRIMARY + SEC. CIRCUIT TUNING COND. WITH RESISTORS OF A CERTAIN VALUE.*





## THE VALUE OF REVIEW

Man has acquired so much new knowledge in recent years that it has become impossible for one person to know even a small fraction of the available information. Educational authorities realize this fact, and the colleges of today consider a man well-educated if he knows the elementary ideas *and knows where to find other information when he wants it.*

Radio, along with the other fields of endeavor, has outgrown the memorizing ability of the human mind. Also, radio is such a comprehensive field that occasionally you cannot recall important facts previously studied. Review is obviously needed.

Time spent in review several weeks or months after a book is studied will be far more profitable than an equivalent amount of extra time spent on the book initially, for your mind has then had a chance to file and store away the information secured from the first study. Each review results in more information being transferred from the textbook to your mind, and soon, with no conscious attempt to memorize, you will find yourself able to recall an amazing number of valuable facts.

*J.E. Smith*