

If You Didn't Get This From My Site,
Then It Was Stolen From...
www.SteamPoweredRadio.Com



INTERNATIONAL CATALOG

International Crystal Manufacturing Co., Inc., is the manufacturer of precision electronic products for the home, industry and aerospace needs. Administrative offices and manufacturing operations are located in Oklahoma City, Oklahoma. Organized in the late 1940's as a primary manufacturer of high quality precision crystals for frequency control, the company has expanded and diversified its operations. Today, International Crystal also manufactures specialized equipment, including oscillators, multivibrators, frequency meters, alignment oscillators, transmitters, sideband filters, antennas, etc.

International Crystal is a pioneer in the design and manufacture of transceivers for the Citizens Radio service.



International Crystals are manufactured to rigid specifications in a plant where temperature and dust control are two important factors. Every crystal that leaves our plant is subject to many tests that assure the customer of the very best product available. All International crystals are guaranteed for the life of the crystal, subject to certain restrictions under warranty. **Every International crystal or instrument is made to give long life and reliable performance.**

International sells all of its manufactured products direct with the exception of Citizens Radio transceivers and accessories which are sold through dealers and distributors.

New products are marketed only after they have been subjected to a long series of engineering tests.

Customers who are in need of specialized instruments for frequency control are invited to consult us on the design and manufacture of these items.

All International products are guaranteed to meet and exceed specifications as set forth in this catalog.



	PAGE
How to Order.....	4
Technical Data, Crystals.....	9
Low Frequency Crystals.....	11
Typical Circuits and Data.....	12
Medium Frequency Crystals.....	13
Crystal Ovens.....	14
High Frequency Crystals.....	15
Oscillators, Plug-In Transistor.....	16
OX Oscillator Kit.....	18
EX Kits.....	18
EX Crystal.....	18
Accessories.....	19
Frequency Meters, Alignment Oscillators.....	20
Model FM-5000.....	20
Model 812 / 814.....	21
Model 6024.....	22
Model C12M.....	23
FM-2400C.....	24
Model 6000.....	25
Microwave Oven.....	26
Microlite 287.....	27
Microdek.....	27

how to order

International Crystal Mfg. Co., Inc. plant and offices are located in Oklahoma City, Oklahoma. Orders should be placed directly with the Oklahoma City sales office. Orders may be placed by mail, phone, wire, cable or teletype. Office hours are 8:00 a.m. to 4:30 p.m. Monday thru Friday excepting holidays.

Mail:
International Crystal Mfg., Inc.
10 North Lee
Oklahoma City, Oklahoma 73102

Phone:
Area Code 405
236-3741

Western Union TELEX: 071-347

Cable: INCRYSTAL

Bell System TWX: 910-831-3177

PLACING ORDERS AFTER HOURS

For your convenience International has installed the "Automatic Order Taker". At night, on weekends and holidays you may be connected with the "Automatic Order Taker" by dialing Area Code 405 and 236-1818. When placing an order we suggest that you note on slip of paper the following information and then merely read it after you are connected. NOTE: A pause longer than eight seconds when reading your order will automatically disconnect you.

- A. Billing and shipping address as well as your name.
- B. Order Number
- C. Method of Shipment (Air, Parcel Post, C.O.D., etc.)
- D. Quantity
- E. Operating Frequency
- F. Crystal Frequency
- G. Equipment Manufacturer and Model Number. In the case of Motorola please furnish their crystal type number rather than model number.
- H. Whether or not ovens will be used.

After you are connected with the "Automatic Order Taker", if you hear a steady tone it means you need to speak a little louder.

Orders mailed to confirm phone or wire orders must be clearly marked CONFIRMING. International will not be responsible for duplicate shipments made on such orders not marked CONFIRMING.

Phone and wire orders will be processed on information as received and understood. Where the confirming order differs from the original phone or wire order, the original order received by phone or wire will take precedence.

crystals In order to give the fastest possible service crystals are sold direct and are not handled by any jobber.

In order to assure accuracy and prompt delivery of crystals for commercial applications, we suggest that the customer provide the following information when ordering or requesting quotations.

If you are ordering crystals for existing commercial equipment the order should include MODEL, TYPE NUMBER and MANUFACTURER, OPERATING FREQUENCY, CRYSTAL FREQUENCY, and whether the crystal is for OVEN or NON-OVEN operation.

When no reference to equipment is known the customer should provide the CRYSTAL FREQUENCY, HOLDER TYPE, OPERATING TEMPERATURE, FREQUENCY TOLERANCE, and FREQUENCY STABILITY. Customer should specify oscillator load capacitance or furnish a copy of oscillator circuit. When the crystal frequency is specified, the customer should indicate whether or not he desires a check of his calculations.

Space prohibits us from listing detailed information required for all makes of commercial equipment. We list the following manufacturers as a guide to specific information required.

CRYSTALS FOR COMMUNICATIONS COMPANY EQUIPMENT should specify Comco part number as well as crystal frequency. Indicate whether the crystal is for oven or non-oven use.

CRYSTAL ORDERS FOR GENERAL ELECTRIC EQUIPMENT should specify the model number of transmitter and receiver RF decks. Example: 4ES13A1, 4ER24BI, 4ET5B3, etc. For 450 MHz equipment specify (1) whether transmitter crystals are oven or non-oven. (2) For receiver crystals (450 MHz) specify if they are oven or non-oven, if the unit is AFC or non-AFC, and the platter number of the present receiver deck.

CRYSTALS FOR MOTOROLA EQUIPMENT can only be properly correlated if the crystal type number is given. Example: DO2, R28, DO3 etc. In cases where the crystal is required for type D-14, 800 and 801 holders, always specify the crystal frequency or the high IF frequency. Check whether the crystal is to be used in ovens.

INFORMATION FOR RCA EQUIPMENT should include the model number or MI number of the crystal. Always indicate whether the crystal is to be oven or non-oven type.

For other commercial equipment specify the model number of the receiver and transmitter as well as any formulae that pertains to the correct crystal calculation.

remember just any crystal will not work properly in every make of commercial equipment. International Crystal Manufacturing Co., will furnish the equivalent crystals to meet specifications set forth by the manufacturers of commercial two-way radio equipment.

equipment All items should be ordered by CATALOG NUMBER. Normally it will be necessary to list the desired operating frequencies, eg: on converters — the incoming signal frequency and the desired output frequency IF desired. Frequency meter orders require the channel frequency being measured and switch position desired. Most equipment will require 10 days processing time for crystal and tune-up on the customers specific frequency. Items not requiring this work will be shipped from stock.

terms All shipments are made FOB our Oklahoma City plant. Cash should accompany the order unless prior credit has been arranged. Include sufficient remittance to cover shipping costs. Open account shipments are net 30 days from date of invoice unless otherwise noted. All orders received with insufficient remittance will be returned unless a statement is included with the order giving permission to ship balance COD. All COD orders of \$25.00 or more require 1/3 deposit with order.

COD orders shipped and refused by the customer for whatever reason will be held 15 days for the customer to forward his remittance. After that period it will be necessary to place a new order on a cash-with-order basis.

sales taxes Residents of Oklahoma, Missouri, and Kansas add 3% sales tax or furnish your retail sales tax permit number.



Fourth-Class (Parcel Post) Zone Rates

Ship. Wt.	ZONES							
	Local	1 & 2	3	4	5	6	7	8
2 lbs.	\$0.60	\$0.65	\$0.70	\$0.75	\$0.80	\$0.90	\$1.00	\$1.05
3 lbs.	.60	.75	.80	.85	.95	1.10	1.20	1.35
4 lbs.	.65	.80	.85	.95	1.10	1.30	1.40	1.60
5 lbs.	.70	.85	.90	1.05	1.20	1.45	1.65	1.90
6 lbs.	.70	.95	1.00	1.15	1.35	1.60	1.85	2.10
7 lbs.	.75	1.05	1.10	1.25	1.50	1.75	2.10	2.35
8 lbs.	.75	1.10	1.15	1.35	1.60	1.90	2.30	2.60
9 lbs.	.80	1.15	1.20	1.45	1.75	2.05	2.45	2.85
10 lbs.	.80	1.20	1.30	1.55	1.90	2.20	2.65	3.10
11 lbs.	.80	1.25	1.35	1.60	2.00	2.30	2.85	3.35
12 lbs.	.85	1.30	1.45	1.70	2.10	2.45	3.05	3.55
13 lbs.	.85	1.35	1.55	1.80	2.20	2.60	3.25	3.80
14 lbs.	.90	1.40	1.60	1.90	2.35	2.75	3.45	4.00
15 lbs.	.90	1.45	1.65	2.00	2.45	2.85	3.60	4.20
16 lbs.	.95	1.55	1.75	2.05	2.55	2.95	3.80	4.40
17 lbs.	1.00	1.60	1.80	2.15	2.65	3.10	3.95	4.60
18 lbs.	1.00	1.65	1.90	2.20	2.75	3.20	4.15	4.80
19 lbs.	1.05	1.70	2.00	2.30	2.85	3.35	4.30	5.00
20 lbs.	1.05	1.75	2.05	2.40	2.95	3.50	4.50	5.20

Add for Insurance		Canadian Postage Rates	
To \$10 value.....	10¢	1st 2 lbs.....	80¢
To \$50 value.....	20¢	Each add'l lb.....	30¢

DISTANCE FROM OKLAHOMA CITY

Local Zone	In Oklahoma City
Zones 1 & 2	not over 150 mi.
Zone 3	151 to 300 mi.
Zone 4	301 to 600 mi.
Zone 5	601 to 1000 mi.
Zone 6	1001 to 1400 mi.
Zone 7	1401 to 1800 mi.
Zone 8	Over 1800 mi.



minimum billing The minimum billing per order is \$5.00. This applies to all orders except cash-with-order transactions.

shipping instructions Unless specific instructions accompany the order, International will use its own judgement as to the best method to ship. If billing and shipping addresses differ this should be clearly noted on the order.

crystal tolerance Calibration tolerance and temperature tolerance shall be as specified for the part type crystal ordered. Crystals will be calibrated within these tolerances working into the load or jig specified. Calibration and temperature tolerances are additive and therefore the exact crystal frequency will depend on the circuit adjustment in which the crystal is used.



conditions of sales Prices and design are subject to change without notice. We reserve the right to discontinue any item without notice and to change specifications at anytime without incurring any obligation to incorporate new designs in units or parts previously sold.

export orders Prices quoted for U. S., Canada and Mexico only. Orders for shipment to foreign countries (exclusive of Canada and Mexico) will be quoted on request. Minimum



order \$25.00. Orders for export will be shipped FOB our factory in Oklahoma City, Oklahoma.

If previous credit has not been established, Irrevocable letter of credit or cash in U. S. Dollars, including a margin for postage should accompany the order.

In the event that a letter of credit will be used as a means of forwarding remittance, the letter must not expire for a period of six months after the placement of order.

The terms of the letter of credit should request air express shipment, with two copies of air express waybill and six (6) copies of our Commercial Invoice. We will be pleased to include a copy of an Insurance Certificate if required.

Please keep in mind that the Import License must be obtained by the customer, and all letter of credit charges will be reflected back to the customer.

If a United States Export License will be required, a fee of \$15.00 will be charged, and must be considered in your remittance or irrevocable letter of credit.

Please note that all letters of credits submitted are subject to our approval in regard to terms, and expiration dates.

Mexican Orders totaling \$16.00 U.S. or more must include a Mexican export number or instructions to forward to a U.S. exporter, including exporters name and address.

return crystal policy International is engaged in the manufacture of custom crystals, processed to operate in a specified circuit and on a specified frequency for two-way communication. Orders in the GP type are processed to the frequency specified by the customer and they are usually intended for general application. Keeping the above in mind, it can be readily seen why crystals returned to this Company, for exchange, are of very little value, since the possibilities of another customer ordering the exact same crystal are many thousands to one. Crystals returned to this Company will be handled in two general categories. Those which are defective, and those units which the customer has ordered in error, and has returned for exchange of a new crystal within 15 days.

When returning crystals, the customer must refer to the ICM Factory Order Number, or the customer's Order Number, and the approximate date of purchase.

WARRANTY

CRYSTALS

1. Crystals will be within tolerance and are guaranteed only to work in the equipment or oscillator load specified.
2. All International Crystals are guaranteed against defective materials and workmanship for an unlimited time when used in the correct equipment or oscillator load.
3. All crystals should be checked immediately upon receipt. Any damage must be reported to International Crystal within 10 days of receipt of order. The crystals should then be returned for inspection and replacement. Credit will not be allowed after this 10-day period for crystals damaged in the mails.
4. Crystals are custom made to order and are not stock items. Units therefore may be returned only under the conditions specified in our return material policy.

(NOTICE) PLEASE DO NOT RETURN GOODS WITHOUT OUR SHIPPING INSTRUCTIONS.

EQUIPMENT

International Crystal Manufacturing Company warrants the parts and tubes in any international equipment to be free from defects in workmanship and material arising from normal usage. Its obligation under this warranty is limited to replacing any such parts or tubes of the receiver which, after regular installation and under normal usage and service, shall be returned within ninety (90) days from the date of original purchase of the unit to International and which shall be found to have been thus defective in accordance with the policies established by International Crystal Manufacturing Company.

The obligation of International Crystal Manufacturing Company is limited to making replacement parts available to the purchaser, and does not include either the making or the furnishing of any labor in connection with the installation of such replacement parts nor does it include responsibility for any transportation expense.

International Crystal Manufacturing Company assumes no liability and shall not be liable in any respect for failure to perform or delay in performing its obligations with respect to the above warranty if such failure or delay results, directly or indirectly, from any preference, priority or allocation order issued by the Government or because of any other act of the Government, or by war, conditions of war, inadequate transportation facilities, conditions of weather, act of God, strikes, lockouts, Governmental controls, or International's reasonable requirements for manufacturing purposes, or any cause beyond its control or occurring without its fault, whether the same kind or not.

CONDITIONS AND EXCLUSIONS

This warranty is expressly in lieu of all other agreements and warranties expressed or implied, and International Crystal does not authorize any person to assume for it the obligations contained in this warranty and neither assumes nor authorizes any representative or other person to assume for it any other liability in connection with such international units or parts or tubes thereof.

The warranty herein extends only to the original consumer purchaser and is not assignable or transferable and shall not apply to any unit or parts or tubes thereof which have been repaired or replaced by anyone else other than an authorized service contractor or distributor, or which have been subject to alteration, misuse, negligence or accident, or to the parts or tubes of any receiver which have had the serial number or name altered, defaced or removed.

Technical data, crystals

defective crystals All International Crystals are guaranteed against defective materials and workmanship for an unlimited time when used in the correct equipment or Oscillator load. These crystals are custom made to your order and are not stock items, therefore, the *guarantee applies only to the crystal in the field.* When it is necessary to request replacement crystals by phone, wire or letter, the crystals will be forwarded and billed, or shipped COD as the case may be.

If replacements are ordered, the defective crystal, when returned, will be tested and inspected for operation in the circuit for which they were originally processed, and if found to be defective because of defective material or poor workmanship, will be repaired or replaced on a no-charge basis and returned as spares. Physical damage to the crystal does not come under this warranty, and if the crystal has been found to be broken, or opened in the field, it cannot be repaired or replaced on a no-charge basis. It is very important that the crystals be checked immediately upon receipt since credit will not be allowed for crystals damaged in the mail, unless they are reported within 10 days after receipt of the order. Crystals found defective because of operation in circuits producing excessive drive will be returned to the customer with no action taken.

crystals returned because of customer error within 15 days from the date of purchase: When crystals are returned due to an error made on the customer's part in specifying incorrect ordering data, the crystal will fall in one of two groups.

1. Frequency change required is .01% or less.

Crystals in this group can normally be opened and the calibration plating adjusted to make the required frequency change. All aging and test cycles must be repeated. Cost per unit: 50% of catalog price.

2. Frequency change required is more than .01%.

Crystals in this group require a complete new unit including regrinding of the blank, new plating, new cover and base, calibration, and all aging and test cycles. Cost per unit: 80% of catalog price.

It should be explained that upon receipt of a returned crystal, the unit cannot be stocked for reasons stated above. It is therefore neces-

sary to dismantle the crystal unit, and salvage such material possible. Normally, the crystal blank can be removed, and the crystal base salvaged. The remainder of the unit is of no value. The crystal blank must be returned to the plating department for cleaning and replating. It can therefore be understood that actually more work is involved in salvaging the crystal unit, than is required for processing new material going through the line.

HOLDER NOMENCLATURE

- GP — general purpose — calibrated $\pm .01\%$ when operated into 10, 20, or 32 pf load capacitance on fundamental and series resonance or anti-resonance (AR) on the overtone. GP crystals will hold temperature tolerance of $\pm .005\%$ from -30° to 60° C.
- CS — commercial standard — calibrated $\pm .0025\%$ as specified for operation in oscillator. CS crystal will hold temperature tolerance $\pm .003\%$ -30° to $+60^\circ$ C.
CS-1 — same as above except calibration tolerance $\pm .001\%$. Note 1: In some instances we use CS-1 to cover special parameters other than calibration, however it will (CS-1) be followed by the word special (SP).
- HA—high accuracy—calibration tolerance $\pm .0025\%$ as specified for operation in oscillator. HA crystal will hold better than $\pm .002\%$ -30° C to $+60^\circ$ C. Note 1 will apply.
HA-5 — same as above except will hold better than $\pm .0005\%$ from -10° C to $+60^\circ$ C. Note 1 will apply. Also could be $\pm .001\%$ calibration, but not necessarily temperature tolerance.

4. Holder Types —

Used On Order	Actual Holder	EXAMPLE:
05	F-605	
09	F-609	
M1	FM-1	HA-M2
M2	FM-2	
M3	FM-3	
12	F-612	
700	F-700	High Accuracy
N	Notch Pins	
SL	Slim Line	
14	FI-4	
13	F-13	CS-05
Short	Short Can	
SP	Special	
WGL	With ground lead	Commercial Standard

international crystal takes considerable effort to insure that the customer receives the correct crystal. In cases where insufficient information is presented, it will not be possible to determine an error the customer may have made in calculating his crystal frequency. Under these conditions, International Crystal Mfg. Co. cannot be responsible.

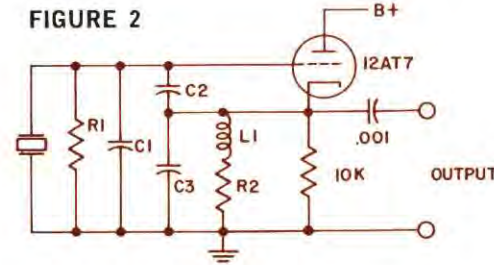

FIGURE 2

	3 MHz to 16 MHz	1 MHz to 3 MHz
R1	100 K	1 Meg.
R2	330 Ω	3.9 K
C1	22 mmf	22 mmf
C2	12 mmf	12 mmf
C3	75 mmf	75 mmf
L1	5 MH	7.5 KH

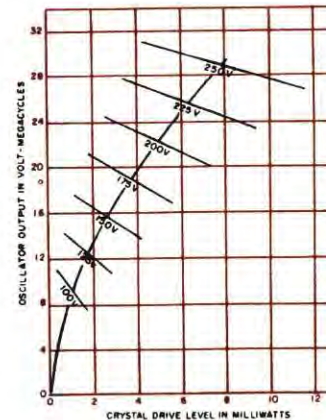

FIGURE 3

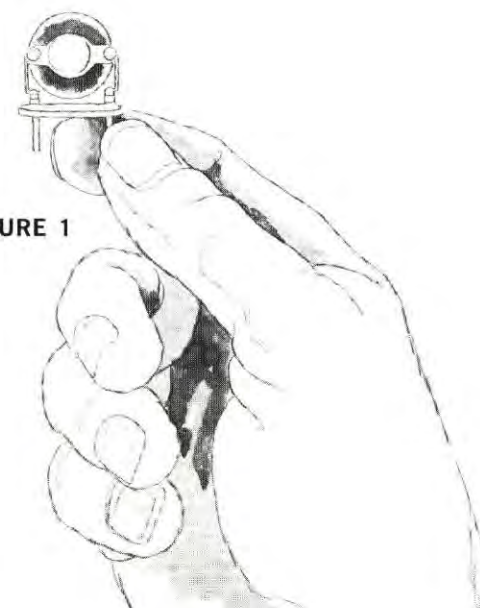

FIGURE 1

The plated crystal consists of a quartz blank with electrodes plated directly on the blank. Silver and gold are the common metals used for the electrodes. Plating is done by one of three methods: evaporation under high vacuum; sputtering with low vacuum; or a system of furnace-firing silver or gold paints.

After plating, the blank is mounted on a base similar to that shown in figure 1. Spring loops on the ends of the mounting wires hold the blank, and also make electrical contact with the electrodes. Additional mechanical and electrical contact is made by placing a small amount of conductive, thermal-setting cement at the contact points. The blank mounted on its base is then calibrated to its final frequency, after which the can and base are soldered together. The entire unit is evacuated and either sealed off under vacuum or filled with dry air and then sealed off. The plated crystal has the advantage over the pressure mounted crystal of greater mechanical stability, permitting closer calibrating and temperature tolerances.

The plated crystal has the disadvantage of not being able to dissipate as much internal heat as the pressure mounted crystal, and will therefore not operate with as high-drive levels.

Room temperature stability in the order of a few cycles can be obtained from the plated crystal when operated properly. Over driving causes heating, instability, and may result in damage if excessive drive levels are used.

FUNDAMENTAL CRYSTAL CIRCUITS

The crystal oscillating in its fundamental mode should be used in circuits where the drive level is limited to 10 milliwatts below 10,000 KHz and to five milliwatts between 10,000 kc and 15,000 KHz. The modified Colpitts type of circuit is becoming widely used. This circuit in triode form is shown in figure 2.

The output of this circuit with a crystal of average activity, with various plate voltage, can be found in figures 3 and 4. The crystal drive is also indicated from these figures. The circuit in figure 2 is designed to offer a load capacitance of 32 mmf to the crystal.

The correct load capacitance of the oscillator is extremely important in operation of the crystal, if the frequency of oscillation is to be within tolerance for which the crystal was manufactured. Deviation from the specified load capacitance causes a shift in the frequency of the crystal. This shift becomes larger the higher the crystal frequency, and the greater the deviation.

The CS crystals, in the fundamental range can be furnished to operate into 32 mmf. The GP type in the fundamental range are furnished only for a 32 mmf load.

To reproduce 32 mmf precisely, lead lengths and position must be taken into account. In figure 2, capacitors C1, C2 and C3, together with tube and wiring capacitance determine the frequency.

Further information on oscillator design will be furnished upon request.

PLATED OVERTONE CRYSTALS

The use of overtone crystals is becoming common in high frequency communications. Crystals oscillating in this manner, actually generate energy on the overtone frequency, eliminating several multiplier stages required when the crystal is oscillating on its fundamental. In equipment design this eliminates many spurious responses.

The plated crystal for overtone use is processed in the same manner as that for fundamental use, with the exception of blank finish. Normally, a finer finish is used, especially for the higher frequencies.

The crystal operated on one of its overtone modes oscillates in several layers, depending upon the mode. The frequency of oscillation is approximately the mode number times the blank frequency. Crystals calibrated for overtone operation are finished at the mode frequency, and the blank fundamental does not enter the calibration. For example, an 8,000 KHz crystal when operated in an overtone oscillator, tuned to 24 MHz, oscillates somewhat above 24,000 KHz.* Since the overtone frequency is not an even multiple of the fundamental, in making an overtone crystal, the frequency of oscillation must be measured with the crystal oscillating on its overtone frequency. (*or about 24,010 KHz).

OVERTONE CRYSTAL CIRCUITS

International overtone crystals are calibrated to operate at anti-resonance into an unloaded grid circuit. When oscillating at series resonance, the crystal frequency will be between 1 KHz and 2 KHz lower.

In the operation of overtone crystals, the energy returned to the crystal must be of overtone frequency. This requires that the overtone crystal oscillator always use a tuned circuit. The circuit shown in figure 5 is the simplest overtone circuit to construct. This circuit will operate up to 60 MHz, using 3rd overtone crystals. Here again low-drive level is the important thing. The crystal should be used to generate a stable signal voltage and the power obtained in succeeding stages. Overtone crystals in the higher frequencies are only a few mils thick. Excessive drive will damage them. The circuit shown in figure 5 provides stable oscillation and reasonable output. Operation on the third mode produces better overall results, than using the higher modes. A maximum drive level of 2 milliwatts should be observed with overtone crystals. International plated overtone crystals have high activity, and are constructed especially for overtone use.

Over-driving the overtone crystal will cause unstable operation. Most problems encountered in the use of plated overtone crystals can be traced to excessive drive.

SELECTING THE PROPER CRYSTAL

Several facts should be considered other than frequency. The final oscillating frequency of the crystal is affected by the associated oscillator circuit through the reactive load and drive levels. For close tolerance operation and oven use, the ambient temperature also must be considered. Table 1 indicates the magnitude of change in the frequency of a given crystal when varying the load capacitance into which it is operating.

In the manufacture of crystals, certain limits must be adhered to when finishing the unit. Such limits are often held to better than .001% for commercial applications. Tolerances of this magnitude mean nothing unless the oscillator in which the crystal is to operate is an exact reproduction of the oscillator in which the crystal was calibrated. This same thing applies to wider tolerances. Persons doing work where closer tolerances are required (Broadcast, Commercial Two-Way, Civil Defense, CAP, etc.) should keep this in mind.

For overtone operation, crystal units especially processed for mode operation produced better results than fundamental types. Overtone crystals are calibrated on their overtone frequency and, therefore are accurate frequency control units. Overtone crystals are valuable for receiver-converter applications and are normally not used in transmitters, since only a small amount of power is available under stable operating conditions. Overtone crystals are calibrated either for series resonance or parallel resonance operation. **Temperature** — All crystals processed by International use "Zero Coefficient" cuts. Blank angles are held to closer tolerance in the CS units and, therefore, will change less over a given temperature range than the GP units. Tolerances are listed in table 3.

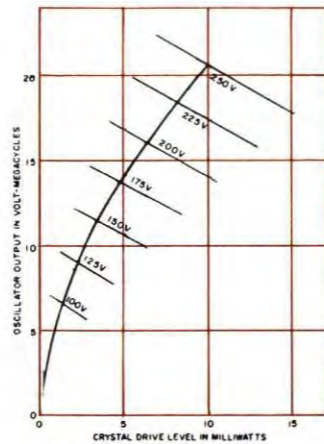

FIGURE 4

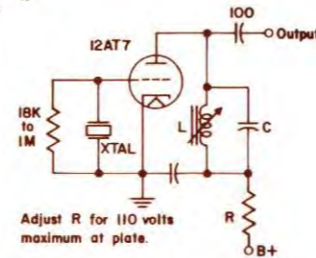

FIGURE 5

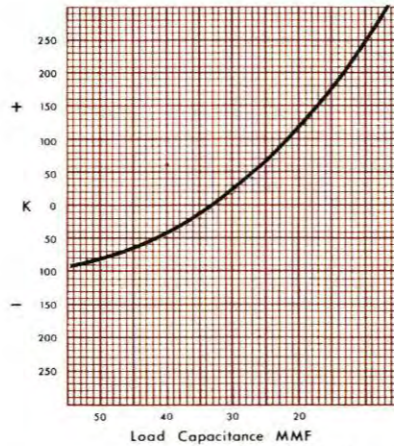

TABLE 1

Type	Load Capacitance or Oscillator	Calibrating Tolerance in Specified Load	Temp. Tolerance -30 C to +60 C
CS (fundamental)	Specified by customer (Use in commercial equipment)	±.0025%	±.003%
CS (overtone)	Specified by customer (Use in commercial equipment)	±.0025%	±.003%
GP (fundamental)	32 mmf (only)	±.01%	±.005%
GP (overtone)	Anti-resonate operation without additional load. (See circuit with crystal)	±.01%	±.005%

TABLE 3

Tolerances listed apply only to AT cut type of crystal. In low frequency ranges, using other cuts, the tolerances will be plus or minus .02%.

Low frequency crystals

70 KHz—999 KHz

On this page we present our four most popular crystal mountings and the data for the crystals available in these mountings according to the various frequency ranges.

mode of oscillation

- 70-184 KHz Length shear 5°X
- 185-599 KHz Edge shear CT & DT
- 600-999 KHz Face shear AT

shunt capacitance 7 pf (Max.)

- 70-200 KHz 10000-7000 ohms
- 200-500 KHz 6500-11000 ohms
- 800-999 KHz 625 ohms

drive (Max.)

- 70-499 KHz 2 milliwatts
- 500-999 KHz 10 milliwatts

REMEMBER: Just any crystal and just any oscillator will not combine to produce designated spot frequencies!

DESCRIPTION AND DATA: All of these crystals are of the plated, wire-mounted type. Low drift AT-cut blanks are used in these units above 600 KHz, and low drift CT cut blanks are used in units below 600 KHz; any crystal can be supplied for operation with or without an oven.

TYPE SPECIFICATIONS

- General Purpose (GP)** crystals will be calibrated to within ±.02% of frequency when operated into the customers specified fundamental load capacitance only (32 pf will be used when none is specified). GP crystals 500-000 HKz will hold temperature tolerance of ±.005% from -30° to 60°C and ±.02% for frequencies below 500 KHz.
- Commercial Standard (CS)** crystals will be calibrated as noted below, as specified for operation in customers load. CS crystals will hold temperature tolerance ±.003% -30° to 60°C above 500 KHz and ±.02% below 500 KHz. **CIRCUIT:** As specified by customer. Crystals are available for all major two-way equipment and in most cases the necessary correlation data is on file. Where circuit is not specified, the crystal will be calibrated for operation into a load capacitance of 32 mmf. Typical circuits for the different frequency ranges are shown on the following page. The CS series of crystal units is available to commercial or military specifications demanding tight frequency tolerance, long term stability and low frequency response.

WHEN ORDERING — SPECIFY THE FOLLOWING FOR EACH CRYSTAL

- Crystal frequency
- Type GP or CS
- Calibration temperature (Room Temperature or Over 60°C)
- Holder (see above)
- Circuit load and correlation data.
Note: For GP specify 10, 20 or 32 pf. Do not specify equipment types in the case of GP crystals. These are made only to 10, 20 or 32 pf load. When circuit load is not specified crystals will be correlated for a 32 pf load.

FREQUENCY	TYPE			
	GENERAL PURPOSE (1)		COMMERCIAL STANDARD (2)	
	Calibration Tolerance As Noted		Calibration Tolerance As Noted	
70- 99 KHz	.02%	\$20.00	.01%	\$22.25
100-199 KHz	.02%	13.25	.01%	15.25
200-499 KHz	.01%	13.25	.005%	15.25
500-849 KHz	.01%	37.25	.0025%	39.25
850-999 KHz	.01%	13.25	.0025%	15.25

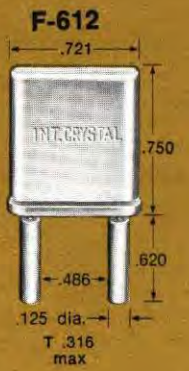

typical circuit

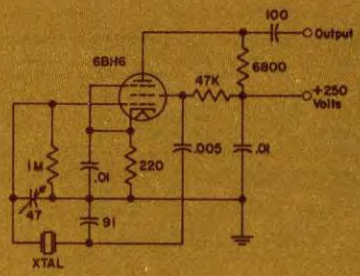

70 - 200 KHz

This circuit includes a variable capacitor for precise adjustment of the crystal frequency. It offers a load capacitance of 32 mmf to the crystal. This circuit may be used for frequencies up to 10 MHz.

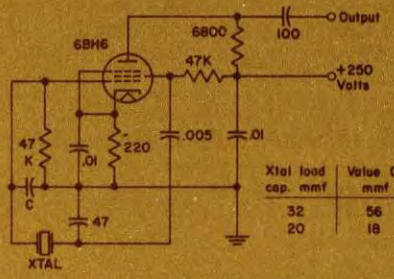

200 - 20,000 KHz

Room temperature stability of a few cycles can be obtained with this circuit. Driving power will average about 5 milliwatts. By making capacitor C variable, exact frequency can be obtained.

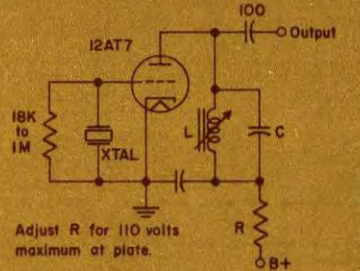

10 - 60 MHz

Third mechanical overtone operation requires a tuned output circuit. This circuit is simple to construct and will operate up to 60 MHz on third overtone crystals with reasonable output.

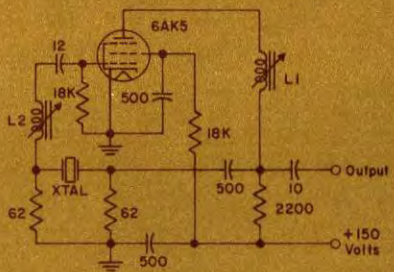

60 - 137 MHz

Fifth or seventh mechanical overtone will be derived from this circuit. Drive level must be kept below 2 milliwatts.

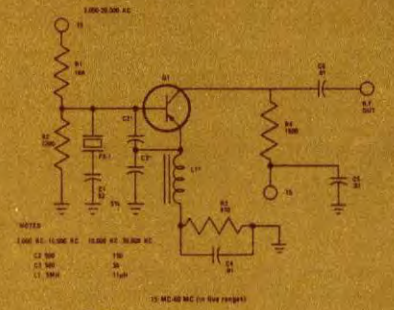

2,000 - 20,000 KHz

This transistor circuit uses a fundamental crystal for frequencies 2,000 to 20,000 KHz. Frequency variation \pm .0005% max with 6 vdc to 15 vdc. See page 17.

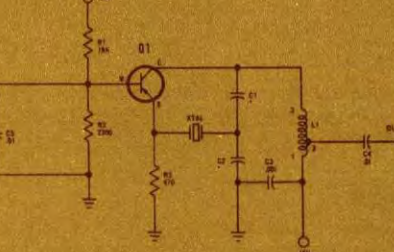

15 - 60 MHz (in five ranges)

This circuit uses 3rd overtone series resonate crystal. Output better than 1.0 volts rms RF across 2200 ohms. See page 16.



Medium frequency crystals 1,000 KHz - 22,000 KHz

FUNDAMENTAL TYPE TYPE SPECIFICATIONS

- GENERAL PURPOSE (GP)** crystals will be calibrated to within \pm .01% of frequency when operated into 10, 20 or 32 pf load capacitance only (32 pf will be used when none is specified). GP crystals will hold temperature tolerance of \pm .005% from -30° to 60° C.
- COMMERCIAL STANDARD (CS)** crystals will be calibrated to either .0025% or .001% as specified for operation in customer's load. CS crystal will hold temperature tolerance \pm .003% -30° to 60° C.
- A calibration tolerance of \pm .001% (or special) can only be obtained when a definite circuit load capacitance and drive level are specified. Where a definite load capacitance is not specified and correlation is required from a copy of the intended circuit a tolerance of \pm .01% should be expected.
- HIGH ACCURACY (HA)** crystals are for use in circuits where tolerances better than \pm .002% -30° to 60° C are required. Tolerances of .0005% over the range -30° to 60° C will require circuit compensation. Without compensation the range will be limited to -10° to 60° C. Compensators are not included with the crystals and tolerance is for crystals only and does not allow for any change in circuit parameters over the temperature range.

- mode of oscillation
1,000-22,000 KHz Face shear AT
- shunt capacitance 7 pf (max.)
7 pf (Max.)
- resistance
1,000- 1,499 KHz 490 ohms
1,500- 1,999 KHz 375 ohms
2,000- 2,999 KHz 270 ohms
3,000- 3,999 KHz 150 ohms
4,000-22,000 KHz 75 to 25 ohms
- drive (max.)
1,000- 9,999 KHz 10 milliwatts
10,000-22,000 KHz 4 milliwatts

WHEN ORDERING — SPECIFY THE FOLLOWING FOR EACH CRYSTAL

- Crystal frequency
- Type — GP, CS, or HA
- Calibration tolerance — .0025% or .001% / Special (not required for GP as this type is supplied only in .01%).
- Calibration temperature (room temperature or over 60° C, 75° C, 85° C)
- Holder (see above)
- Circuit load and correlation data
Note: For GP specify 10, 20 or 32 pf. Do not specify equipment types in the case of GP crystals. These are made only to 10, 20 or 32 pf load. When not specified crystals will be correlated for a 32 pf load.

*Available 2,000-2,999 KHz
**FM Holder Available 6,000 to 22,000 KHz

FREQUENCY	TYPE			
	GENERAL PURPOSE(1)	COMMERCIAL STANDARD(2)		HIGH ACCURACY(4)
	Calibration Tolerance .01%	Calibration Tolerance .0025%	.001% / CS - 1 Special(3)	Temperature Tolerance -10° to $+60^{\circ}$.002% .0005%
1,000- 1,499 KHz	\$8.25	\$10.25	\$12.25	
1,500- 2,999 KHz	6.15	7.15	8.15	\$ 8.25*
3,000-10,999 KHz	4.50	5.10	6.15	6.30 \$ 9.50**
11,000-19,999 KHz	6.15	7.15	8.15	8.25 9.50
20,000-22,000 KHz	8.25	10.25	11.25	11.25 12.50

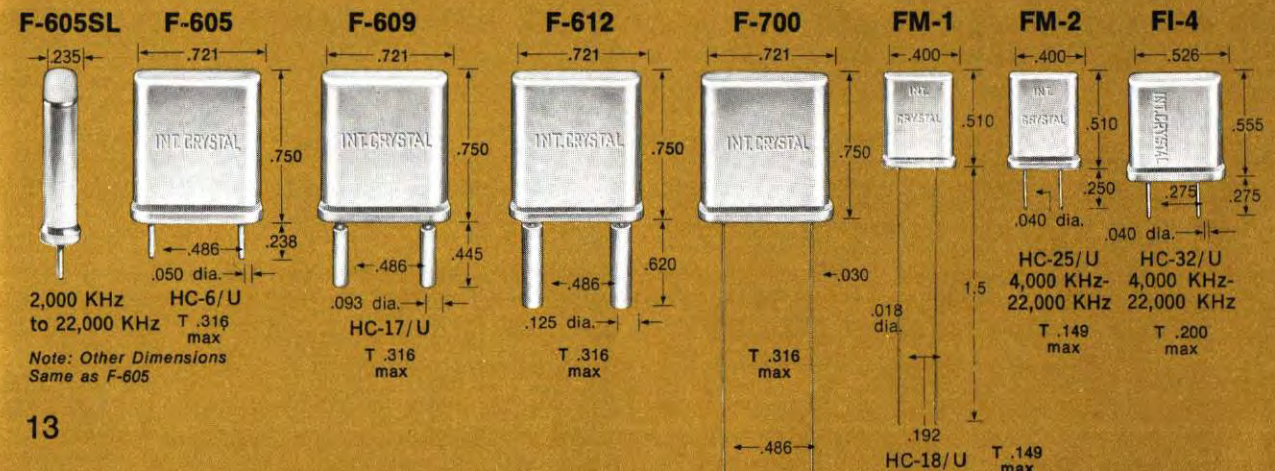

Frequency crystals

160 MHz

Primary equipment can be supplied in accordance with specifications of MIL-C-3098E

SAX-1



TRANSISTOR RF AMP
Lo Kit 3 to 20 MHz
Hi Kit 20 to 170 MHz

BAX-1



BROADBAND AMP
20 Hz to 150 MHz
6 to 30 db gain

MXX-1



TRANSISTOR RF MIXER
Lo Kit 3 to 20 MHz
Hi Kit 20 to 170 MHz

PAX-1



TRANSISTOR RF POWER AMP
3,000 to 30,000 KHz

TYPE EX CRYSTAL
3,000 KHz to 60,000 KHz
HC 6/U Holder



OX OSCILLATOR
Crystal controlled transistor type



Lo Kit 3,000 to 19,999 KHz
Hi Kit 20,000 to 60,000 KHz

	RESISTANCE (Max.)	
1st overtone AT	10- 14.9 MHz	60 ohms
2nd overtone AT	15- 60 MHz	40 ohms
3rd overtone AT	60-110 MHz	60 ohms
4th overtone AT	110-140 MHz	80 ohms
5th overtone AT	140-160 MHz	100 ohms
6th overtone AT	Drive (Max.)	2 milliwatts
7th overtone AT		
8th overtone AT		
9th overtone AT		
10th overtone AT		
11th overtone AT		
12th overtone AT		
13th overtone AT		
14th overtone AT		
15th overtone AT		
16th overtone AT		
17th overtone AT		
18th overtone AT		
19th overtone AT		
20th overtone AT		
21st overtone AT		
22nd overtone AT		
23rd overtone AT		
24th overtone AT		
25th overtone AT		
26th overtone AT		
27th overtone AT		
28th overtone AT		
29th overtone AT		
30th overtone AT		
31st overtone AT		
32nd overtone AT		
33rd overtone AT		
34th overtone AT		
35th overtone AT		
36th overtone AT		
37th overtone AT		
38th overtone AT		
39th overtone AT		
40th overtone AT		
41st overtone AT		
42nd overtone AT		
43rd overtone AT		
44th overtone AT		
45th overtone AT		
46th overtone AT		
47th overtone AT		
48th overtone AT		
49th overtone AT		
50th overtone AT		
51st overtone AT		
52nd overtone AT		
53rd overtone AT		
54th overtone AT		
55th overtone AT		
56th overtone AT		
57th overtone AT		
58th overtone AT		
59th overtone AT		
60th overtone AT		
61st overtone AT		
62nd overtone AT		
63rd overtone AT		
64th overtone AT		
65th overtone AT		
66th overtone AT		
67th overtone AT		
68th overtone AT		
69th overtone AT		
70th overtone AT		
71st overtone AT		
72nd overtone AT		
73rd overtone AT		
74th overtone AT		
75th overtone AT		
76th overtone AT		
77th overtone AT		
78th overtone AT		
79th overtone AT		
80th overtone AT		
81st overtone AT		
82nd overtone AT		
83rd overtone AT		
84th overtone AT		
85th overtone AT		
86th overtone AT		
87th overtone AT		
88th overtone AT		
89th overtone AT		
90th overtone AT		
91st overtone AT		
92nd overtone AT		
93rd overtone AT		
94th overtone AT		
95th overtone AT		
96th overtone AT		
97th overtone AT		
98th overtone AT		
99th overtone AT		
100th overtone AT		

TYPE SPECIFICATIONS

Crystals will be calibrated to within ±.01% of frequency at customer's specified circuit load only. When none is specified, a standard load will be used.

Hold temperature tolerance of ±.005% from room temperature.

GP crystals will be calibrated to either ±.0025% or ±.005% of frequency at customer's load. CS crystal will hold frequency to ±.001% from room temperature to 60°C.

±.001% (or special) can only be obtained when a definite load is specified. Where a definite load is not specified, a standard load is required from a copy of the intended circuit to be expected.

Crystals are for use in circuits where tolerances better than ±.005% are required. Tolerances of .0005% over the range -10° to 60°C. Compensators are not included with crystals. Compensation is for crystals only and does not allow for any other components over the temperature range.

VERIFY THE FOLLOWING FOR EACH CRYSTAL

±.0025% or .001% / Special (not required for GP as this is ±.01%)

Room temperature or oven 85°C

Standard data — normal series resonate or anti-resonate frequencies in the case of GP crystals.

Frequency (MHz)	TYPE			
	Commercial Standard(2)	High Accuracy (3) (4)	Calibration Tolerance (3) CS-1	Temperature Tolerance -10° to +60°
90	\$ 7.15	\$ 8.25	.0025%	.002%
10	11.25	12.25	.001%/special	.0005%
15	15.25	16.25		
15	15.25	16.25		
15.25	18.25	19.25		

See as F-605
5 MHz
FM-2 holder only above 20 MHz

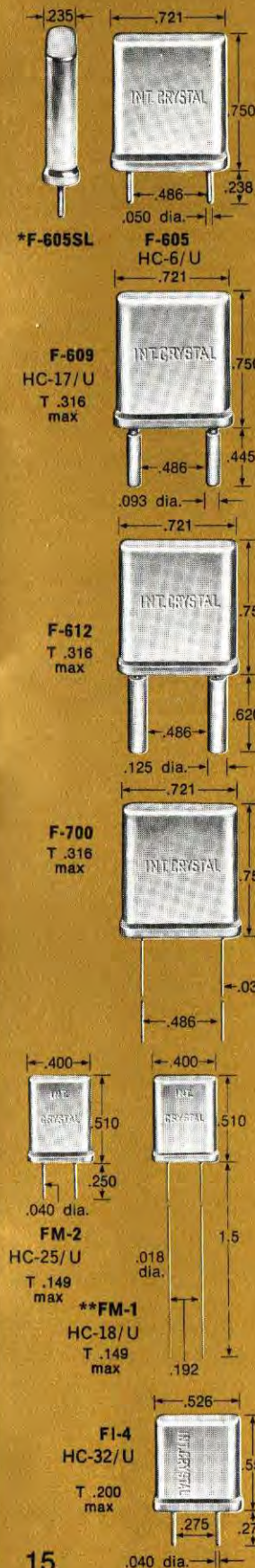

High frequency crystals

10 MHz — 160 MHz

Crystals for use in military equipment can be supplied to conform to specifications of MIL-C-3098E

MODE OF OSCILLATION		RESISTANCE (Max.)	
10- 60 MHz...	Face shear third mechanical overtone AT	10- 14.9 MHz	60 ohms
61-110 MHz...	Face shear fifth mechanical overtone AT	15- 60 MHz	40 ohms
111-140 MHz...	Face shear seventh mechanical overtone AT	60-110 MHz	60 ohms
141-160 MHz...	Face shear ninth mechanical overtone AT	110-140 MHz	80 ohms
		140-160 MHz	100 ohms
		Drive (Max.)	2 milliwatts
Shunt Capacitance		7 pf (Max.)	

TYPE SPECIFICATIONS

- General Purpose (GP)** crystals will be calibrated to within $\pm 0.01\%$ of frequency when operated into the customer's specified circuit load only. When none is specified series resonance will be used. GP overtone crystals will hold temperature tolerance of $\pm 0.005\%$ from -30° to 60°C .
- Commercial Standard (CS)** crystals will be calibrated to either $.0025\%$ or $.001\%$ as specified for operation in customer's load. CS crystal will hold temperature $\pm 0.003\%$ -30° to 60°C .
- A calibration tolerance of $\pm 0.001\%$ (or special) can only be obtained when a definite circuit load and drive level are specified. Where a definite load is not specified and correlation is required from a copy of the intended circuit a tolerance of $.01\%$ should be expected.
- High Accuracy (HA)** crystals are for use in circuits where tolerances better than $\pm 0.002\%$ -30° to 60°C are required. Tolerances of $.0005\%$ over the range -30° to 60°C will require circuit compensation. Without compensation the range will be limited to -10° to 60°C . Compensators are not included with the crystals and tolerance is for crystals only and does not allow for any change in circuit parameters over the temperature range.

WHEN ORDERING — SPECIFY THE FOLLOWING FOR EACH CRYSTAL

- Crystal frequency
- Type — GP, CS, or HA
- Calibration tolerance — $.0025\%$ or $.001\%$ / Special (not required for GP as this type is supplied only in $.01\%$)
- Calibration temperature — Room temperature or oven 85°C
- Holder (see above)
- Circuit load and correlation data — normal series resonate or anti-resonate
Note: Do not specify equipment types in the case of GP crystals.

FREQUENCY	MHZ	TYPE			
		General Purpose(1)	Commercial Standard(2)		High Accuracy (3) (4)
		Calibration Tolerance	Calibration Tolerance (3) CS-1		Temperature Tolerance -10° to $+60^\circ$
		$.01\%$	$.0025\%$	$.001\%$ /Special	$.002\%$ $.0005\%$
15- 60	(3rd)	\$ 4.90	\$ 7.15	\$ 8.25	\$9.50 \$11.00
61- 79	(5th)	6.10	11.25	12.25	
80-110	(5th)	8.15	15.25	16.25	
111-139	(7th)	10.15	15.25	16.25	
140-160	(9th)	15.25	18.25	19.25	

*Other dimensions same as F-605

**Not supplied below 15 MHz

†Available in FM-1 and FM-2 holder only above 20 MHz

Plug-in transistor oscillators

direct crystal control to 160 MHz

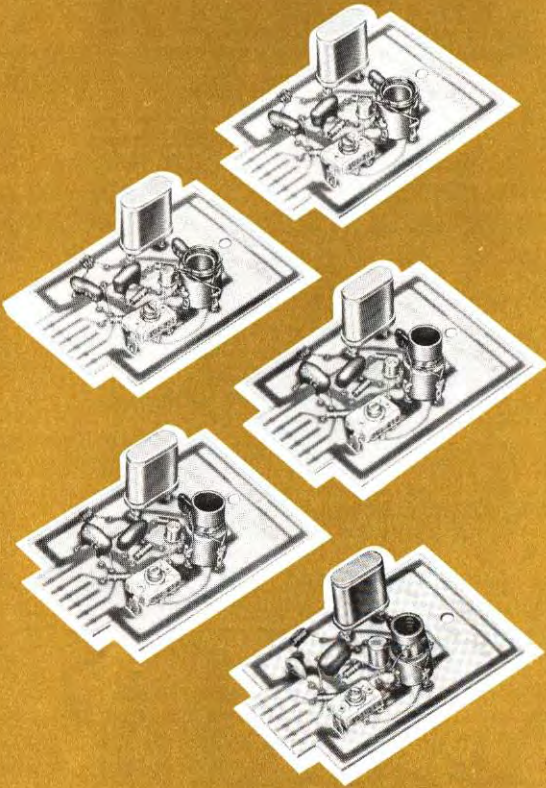

HIGH FREQUENCY (20 MHz — 160 MHz)

- Signal Generators For Receiver Alignment
- Quick-Change Plug-In Oscillators

Five transistor oscillators covering 20 MHz - 160 MHz. Standard 77°F calibration tolerance $\pm .0025\%$. The frequency tolerance is $\pm .0035\%$. Oscillator output is .2 volts (min.) across 51 ohms. Power requirement: 9 vdc @ 10 ma. max.

Oscillator Type	Oscillator Range	Temperature Tol. —40°F to 150°F	Oscillator (Less Crystal) Price
OT- 24	20- 40 MHz	$\pm .0035\%$	\$9.00
OT- 46	40- 60 MHz	$\pm .0035\%$	9.00
OT- 61	60-100 MHz	$\pm .0035\%$	9.00
OT-140	100-140 MHz	$\pm .0035\%$	9.00
OT-160	125-160 MHz	$\pm .0035\%$	9.00

FOR CRYSTALS SEE PAGES 11, 13 AND 15 (TYPE CS ONLY)

LOW FREQUENCY (70 KHz — 20,000 KHz)

- Band Edge Markers ■ Frequency Markers For Oscilloscopes ■ Portable Signal Standards
- Accessory Cases

Four transistor oscillators covering 70 KHz - 20,000 KHz. Trimmer capacitor for zeroing crystal. When oscillator is ordered with crystal the standard will be $\pm .0025\%$. Oscillator output is 1 volt (min.) across 470 ohms. Power requirement: 9 vdc @ 10 ma. max.

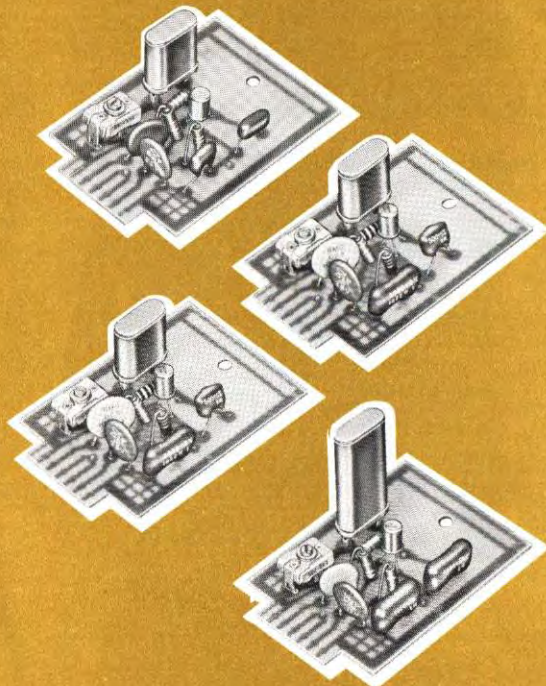

Oscillator Type	Oscillator Range	Temperature Tol. —40°F to + 150°F	Oscillator (Less Crystal) Price
OT-1	70-150KHz	$\pm .015\%$	\$6.00
OT-2A	150-400KHz	200-600KHz $\pm .01\%$	6.00
OT-2	400-5,000KHz	600-5,000KHz $\pm .0035\%$	6.00
OT-3	2,000-12,000KHz	$\pm .0035\%$	6.00
OT-4	10,000-20,000KHz	$\pm .0035\%$	6.00

Oscillator cases



Small portable cases for use with the OT series of plug-in oscillators. Prices do not include Oscillators.

(When oscillator and crystal are ordered with FOT-10 case a 77° F tolerance of $\pm .001\%$ may be obtained at \$2.00 extra per oscillator/crystal unit.

Oscillators — shipping weight: 1 lb. each
Cases — shipping weight: 3 lbs. each

FOT-10

Basic case with battery and output jack for general wider tolerance applications.

\$14.50

MT-1

Oscillator board mounting kit. Provides mounting for International plug-in transistor oscillators. Six contact "T" series mounting with shield.

\$4.95

MT-2

Six contact socket and plate for oscillator case.

\$1.95

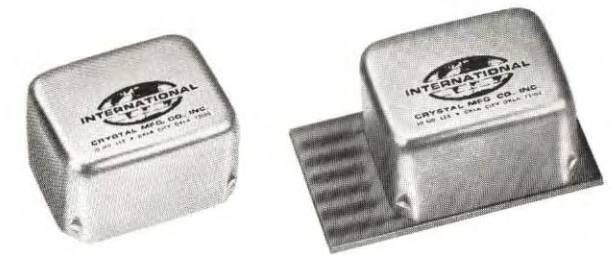

OE CRYSTAL OSCILLATOR ELEMENTS

OE series of Crystal Oscillator Elements provide a complete crystal controlled signal source. The OE units cover the range 2000 KHz to 160 MHz. The standard OE unit is designed to mount direct on a printed circuit board. Also available is printed circuit board plug-in type.

The various OE units are divided into groups by frequency and by temperature stability. Models OE-20 and OE-30 are temperature compensated units. The listed "Overall Accuracy" includes room temperature or 25° C tolerance and may be considered a maximum value rather than nominal.

All OE units are designed for 9.5 volts dc operation and the OE-20; and OE-30 require a regulated source to maintain the listed tolerance.

Prices listed include oscillator and crystal. For the plug-in type add the suffix "P" after the OE number; eg OE-1P.

Oscillator Element Type	2000 KHz to 60 MHz	61 MHz to 139 MHz	140 MHz to 160 MHz	Overall Accuracy	25°C Tolerance
OE-1	\$11.00	\$13.00	\$16.00	$\pm .01\%$ -30° to +60°C	$\pm .005\%$
OE-5	\$16.00	\$19.00	\$25.00	$\pm .002\%$ -10° to +60° C $\pm .00025\%$	$\pm .0005\%$ 2-60MHz $\pm .001\%$ 61 to 139 MHz $\pm .0025\%$ 140 to 160 MHz
3000 KHz to 20000 KHz					
OE-10	\$19.00			$\pm .0005\%$ -10° to +60° C	Zero trimmer
OE-20	\$28.00			$\pm .0005\%$ -30° to +60° C	Zero trimmer
OE-30	\$48.00			$\pm .0002\%$ -30° to +60° C	Zero trimmer

a low cost crystal type EX for the experimenter



\$395
POSTAGE PAID
U. S. ORDERS

Available from 3,000 KHz to 60,000 KHz. Supplied only in HC 6/U holder. Calibration is $\pm .02\%$ when operated in International OX circuit or its equivalent. (Specify frequency)

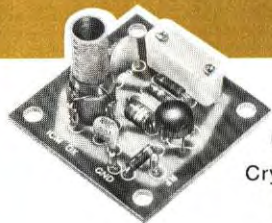

OX Oscillator

Crystal controlled transistor type.
Lo Kit 3,000 to 19,999 KHz
Hi Kit 20,000 to 60,000 KHz
(Specify when ordering)

SPECIFICATIONS:

1. Frequency Range..... LO—3000 KHz to 19999 KHz
HI—20000 KHz to 60000 KHz
2. RF Output..... 2 volts rms into 50 ohms (min)
3. DC Power Required..... 6 volts at 20 ma (operates 4 to 9 volts)
4. Frequency Tolerance with OX and EX Crystal..... $\pm .02\%$
5. Operating Temperature Range..... 0 to 50 Degrees Centigrade
6. Frequency Change with 1 Volt Supply Change..... $\pm .001\%$ (max)
7. Output Level Change with 1 Volt Supply Change..... 2 DB (approx)
8. Size..... $1\frac{1}{2}'' \times 1\frac{1}{2}'' \times 1\frac{1}{4}''$
9. Mounting..... 4 holes with spacers or fits over $1\frac{1}{4}''$ chassis hole

Complete Kit (less crystal)..... **\$2.95**

SAX-1 Transistor RF Amplifier

The SAX-1 transistor rf amplifier is intended as a small signal amplifier to drive the MXX-1 mixer. The circuit has a single tuned input and a link output to the next stage. This output link carries dc to the collector of the amplifier transistor.

SPECIFICATIONS:

1. DC Power Required..... 6 to 12 volts dc @ 7 ma
2. Frequency Range..... LO Kit 3 to 20 MHz
HI Kit 20 to 170 MHz
3. Gain..... 15 db at 3 MHz
10 db at 150 MHz
4. Sensitivity..... Useful to 1 microvolt
5. Input Coupling..... Low Impedance link
6. Output Coupling..... Low Impedance link to next stage (link carries dc to collector)
7. Size..... $1\frac{1}{2}'' \times 1\frac{1}{2}'' \times 1''$
8. Mounting..... 4 holes with spacers
Specify HI or LO Kit when ordering.

Complete Kit..... **\$3.50**



Prices quoted for U.S., Canada and Mexico orders only. Orders for shipment to foreign countries (exclusive of Canada and Mexico) will be quoted on request. Minimum order \$25.00.

PAX-1 Transistor RF Power Amplifier

The PAX-1 transistor rf power amplifier is a single tuned output amplifier designed to follow the OX oscillator. Outputs up to 200 mw can be obtained depending on the frequency and the voltage. The amplifier can be amplitude modulated for low power communications.

SPECIFICATIONS:

1. DC Power Required..... 6 to 12 volts dc @ 20 to 50 ma
2. Frequency Range..... 3 to 30 MHz
3. Output..... 30 mw to 200 mw depending on voltage
4. Drive Required..... OX oscillator
5. Output..... Low impedance link
6. Harmonics..... Down at least 20 db
7. Size..... $1\frac{1}{2}'' \times 1\frac{1}{2}'' \times 1''$
8. Mounting..... 4 holes with spacers

Complete Kit..... **\$3.75**

MXX-1 Transistor RF Mixer

The MXX-1 transistor rf mixer is a single tuned circuit intended for signal conversion in the 3 to 170 MHz range. The MXX-1 requires the OX oscillator for signal injection. Harmonics of the OX oscillator are used for injection in the 60 to 170 MHz range. Use the OX oscillator at $\frac{1}{2}$ injection frequency from 60 to 120 MHz and $\frac{1}{3}$ from 120 to 170 MHz.

SPECIFICATIONS:

1. DC Power Required..... 6 to 12 volts dc @ 7 ma
2. Frequency Range..... LO Kit 3 to 20 MHz
HI Kit 20 to 170 MHz
3. Conversion gain..... 12 db at 3 MHz
6 db at 160 MHz
4. Sensitivity..... Useful to 1 microvolt
5. Input Coupling..... Low Impedance Link
6. Output Coupling..... Untuned resistive
7. Size..... $1\frac{1}{2}'' \times 1\frac{1}{2}'' \times 1''$
8. Mounting..... 4 holes with spacers
Specify HI or LO Kit when ordering.

Complete Kit..... **\$3.50**

BAX-1 Broadband Amplifier 20 Hz to 150 MHz

International BAX-1 Broadband Amplifier is a general purpose unit which may be used as a tuned or untuned amplifier in rf and audio application. For example: when used as untuned rf pre-amplifier connect between antenna and receiver antenna posts. Ideal for SWL, Experimenter or Amateur applications. Easy to build.

SPECIFICATIONS:

1. Power..... 9 to 15 volts dc @ 10 ma
 2. Frequency Range..... 20 Hz to 150 MHz
 3. Gain at 1 MHz..... 30 db
Gain at 150 MHz..... 6 db
 4. Response ref 1 mhs..... down 6 db at 50 hz
 ± 3 db 100 hz to 10 mhz
down 15 db at 100 mhz
down 24 db at 150 mhz
 5. Operational Impedance..... 50 to 500 ohms
 6. Noise..... less than 10 microvolts rf across 50 ohms; audio less than .0005 volts
 7. Maximum Input Level..... .01 volts ac
 8. Output at Maximum Input..... 50 ohms — .1 volt (at 1 mhz)
500 ohms — .5 volt
- Size inches..... $1\frac{1}{2}'' \times 1\frac{1}{2}'' \times 1''$
Mounting..... 4 holes with spacers

Complete Kit..... **\$3.75**



Accessories

AC-95 ADAPTER WITH HOLD DOWN BRACKET
Similar to AC-95 Adapter. Includes metal hold down bracket for replacement of Motorola SFMT-2 Holder.
Cat. No. 150-117..... **\$1.00**



AC-95 ADAPTER
Will adapt F-609 or GP-09 crystal to fit standard 5 prong tube socket.
Cat. No. 150-108..... **\$.30**

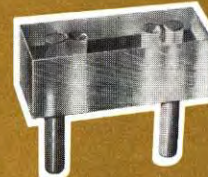

AC-9 CRYSTAL SOCKET
Phenolic to fit F-609 or GP-09.
Cat. No. 150-110..... **\$.15**



AC-5 CRYSTAL SOCKET
Ceramic to fit F-605 or GP-05.
Cat. No. 150-109..... **\$.15**
(Quantity price on request)



FM-2 CRYSTAL SOCKET
Special socket for printed circuit board. For type FM-2 crystal.
Cat. No. 171-108..... **\$.15**



F-605 (Regular) CRYSTAL SOCKET
Special socket for printed circuit board. For type F-605 crystal.
Cat. No. 171-106..... **\$.15**



FI-4 CRYSTAL SOCKET
Special socket for printed circuit board. For type FI-4 crystal.
Cat. No. 171-107..... **\$.15**



SMALL SIGNAL PICK-OFF ATTENUATOR

International's inline barrel attenuators are for use with frequency meters to supply a small amount of rf voltage for measurement purposes. Two models are available, 150-285 for general purpose and low frequency work; and 105-286 for high frequency measurements. The 150-286 attenuator should be used in the 450 MHz range where minimum insertion loss is desired.

	\$19.50 Model 150-285	\$24.50 Model 150-286	
less than .2 db	less than .2 db	Insertion loss 30 MHz	
less than .2 db	less than .2 db	Insertion loss 170 MHz	
less than 4.00 db	less than .75 db	Insertion loss 460 MHz	
less than 28 db	less than 46 db	Minimum attenuation 30 MHz	
less than 14 db	less than 28 db	Minimum attenuation 170 MHz	
less than 8 db	less than 22 db	Minimum attenuation 460 MHz	

Maximum attenuation both models is greater than 60 db. The attenuation required to deliver 250,000 microvolts to the frequency meter with several line powers is listed below.

Power Watts	Attenuation DB
1	29
10	39
50	46
250	53

SAX-1



PAX-1



MXX-1



BAX-1



FM-5000 Frequency meter

International's Frequency Meter, Model FM-5000, is a beat frequency type measuring device. The FM-5000 incorporates a transistor counter circuit, self contained batteries, low RF output for receiver checking, audio oscillator, transmitter keying circuit, and plug-in oscillators, including heating circuits.

FM-5000 Frequency Meter, including batteries, accessories and complete instruction manual, less oscillators and crystals. Shipping weight: 18 lbs.

Cat. No. 620-103.....\$375.00

plug-in oscillators*

1 to 4.....\$25.00 ea.
5 to 24.....15.00 ea.
25 or more.....10.00 ea.

*Oscillator prices are less crystal.
Shipping weight: 2 lbs.

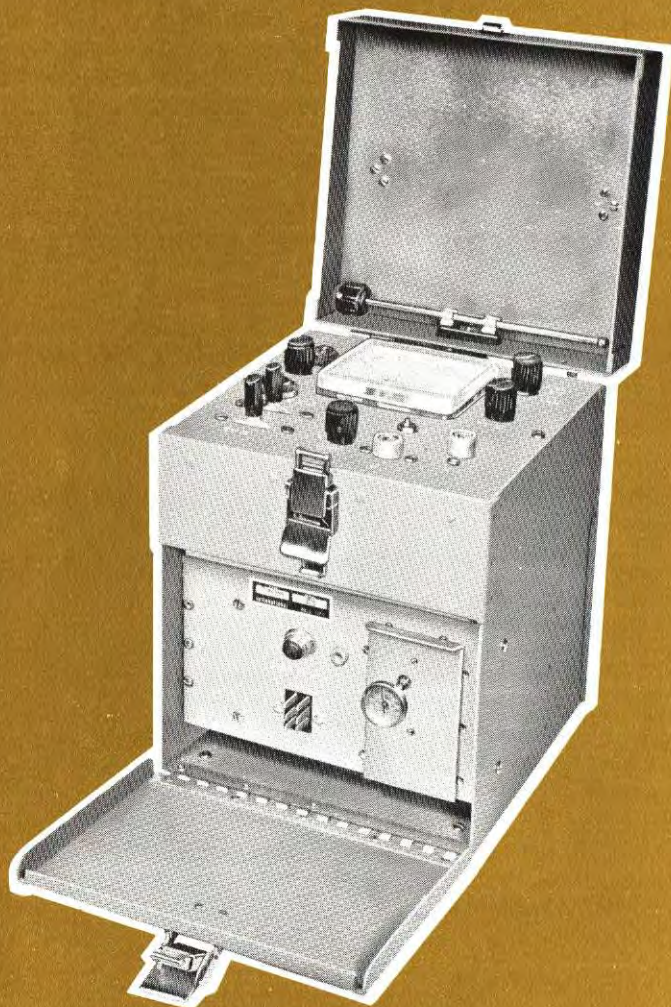

ICM

specifications

- **Crystal Oscillator Unit**
Stability: +85° to +95°F ± .00012%
+50° to +100°F ± .0005%
+32° to +120°F ± .001%
Range: FO-50 100 KHz to 299 KHz
FO-51 300 KHz to 10,999 KHz
FO-53 7,000 KHz to 7,999 KHz
FO-54 8,000 KHz to 10,999 KHz
FO-55 11,000 KHz to 12,550 KHz
FO-58A 11,000 KHz to 14,000 KHz
- **Transmitter Pickup**
Range: 25 MHz to 470 MHz Standard
2 MHz to 25 MHz Special
Sensitivity: 50,000 microvolts at 25 MHz
300,000 microvolts at 470 MHz
across 50 ohms.
- **Counter Circuit**
Frequency Range: 0 to 5 KHz or 0 to 15 KHz
Residual Error: 100 cps at zero beat
- **Audio Oscillator**
Frequency: 2,080 cps
Output: 0 to 1.5 volts rms.
across 50 ohms
- **RF Signal Generator**
Frequency Range: 25 to 470 MHz
Low Output: .5 to 2 microvolts across 50
ohms (uncalibrated)
High Output: Approximately 200 microvolts
open circuit
- **IF Signal Generator**
Frequency Range: 100 KHz to 60 MHz
Output: 10,000 microvolts minimum
- **Battery Power Required**
1½ volts dc at 60 ma ("A" Battery)
135 volts dc at 7 ma ("B" Battery)
18 volts dc at 5 ma
6 volts dc at 25 ma
- **Panel Controls**
Function Selector 7 positions
Battery Test "A"
Battery Test "B"
Calibration
RF
Deviation X1
Deviation X3
Modulation Set
Harmonic Adjust
RF Attenuator
Modulation Set
Counter Calibration
Oscillator B+ Set
Power Off-On
Transmitter/Audio Oscillator Key
- **Oscillator Heating**
Thermostat adjust for 92°F final oscillator
temperature
Plug and cords provided for 115 vac or 6/12
vdc source
Heating Time: Approximately 15 minutes to
85°F from 32°F
- **Dimensions:** 10" x 8" x 7½"
*With calibration every 6 months

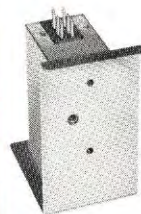

Crystals for oscillators

See type HA page 13. Crystal prices include calibration in the oscillator units for which they are furnished. Price of crystal change in customers oscillator will be the price of the HA crystal, plus \$6.00 calibration charge.

ICM

Alignment oscillators

Designed to Make
Servicing Easier

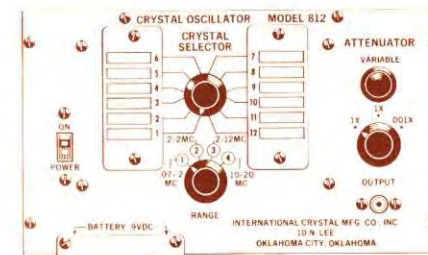

specifications

- Frequency Range:**
.07 MHz to 20 MHz in four ranges selected by a front panel switch.
- Crystals Required:**
Fundamental type CS in F-605 holder (HC-6/U).
- Frequency Tolerance:**
Model 812, each crystal can be adjusted to zero with trimmer for each switch position.
Model 814, fixed trimmed with a maximum calibration error of .01% to be expected when a crystal correlated for the 814 circuit is installed.
- Temperature Tolerance:**
Nominal .002% between 32° and 125°F. Total error will be the combination of calibration and temperature tolerance.
- RF Output:**
Varies over the frequency range, nominal values into 50 ohms; 250,000 microvolts at end ranges and 400,000 microvolts mid-range.
- Harmonics:**
Output waveshape rich in harmonics. Crystals above 2,000 KHz will have useful output (200 microvolts) to 250 MHz.
- Attenuator:**
Step positions of approximately 20 db and 60 db, with variable control of an additional 30db. Some 10 db leakage occurs at the higher range.
- Battery Required:**
1 - type 2N6, 9 vdc or equivalent.
- Battery Life:**
100 hours of operation with average current required of 10ma to 7 vdc end point. No warm-up time is required in operation.
- Freq vs Battery:**
Battery voltage of 7 vdc will cause an error in frequency of .0002%.
Battery voltage of 5 vdc will cause an error in frequency of .0005%.
- Output vs Battery:**
Battery voltage of 7 vdc will cause a drop in output of approximately 2 db.
Battery voltage of 5 vdc will cause a drop in output of approximately 5 db.
- Model 812 complete (less crystals) . . \$125.00
- Model 814 complete (less crystals) . . \$95.00

MODEL 812 (70 KHz — 20 MHz)
MODEL 814 (70 KHz — 20 MHz)



The Models 812 and 814 are crystal controlled test oscillators covering the range .07MHz to 20MHz. The circuit is solid-state, battery powered, with output attenuator for adjusting the output level. The entire unit is housed in a portable carrying case.

The two models differ in that the Model 812 has individual trimmers for each crystal position, allowing this model to be used for closer tolerance work. For application, the Model 812 may be used for .001 percent work and the Model 814 for .01 percent work. The Model 812 can be used for closer tolerances providing a suitable standard is available to check the frequencies periodically.

Both models have positions for 12 crystals, and the entire frequency range is covered in four steps. Front panel area is allowed for applying one-fourth inch embossed tape to indicate the frequency of the crystal in each position. The oscillators are supplied less crystals.

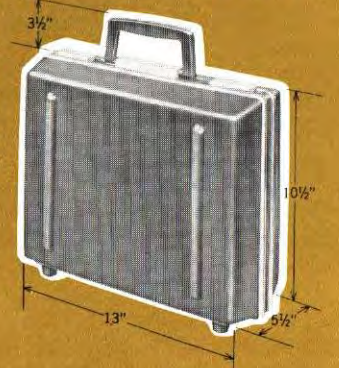



The Three In One 6024 Frequency meter

- secondary frequency standard
- signal generator
- power meter

The 6024 packs three test instruments into one small package for fast, professional servicing on all makes of Citizens Radio transceivers. You have at the flick of a switch, a SECONDARY FREQUENCY STANDARD, range 26.965 to 27.255 MHz with Counter Circuit, zero to 2500 Hz; SIGNAL GENERATOR, 26.965 to 27.555 MHz and DUMMY LOAD/POWER METER, up to 5 watts.

Complete with connecting cable, dummy load, rechargeable battery and charger.....\$345.00

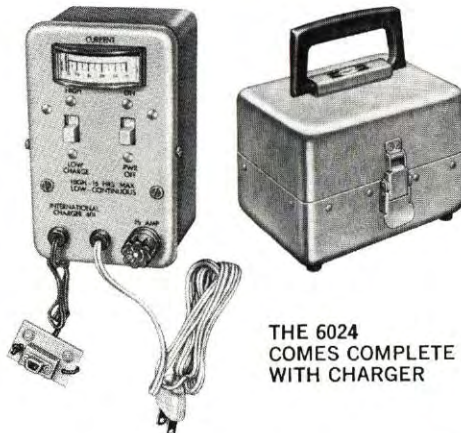
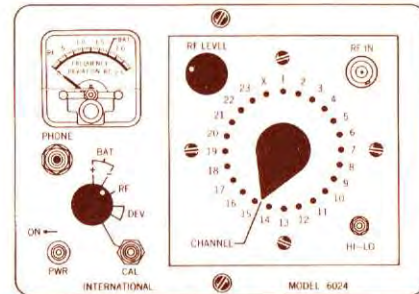

THE 6024 COMES COMPLETE WITH CHARGER

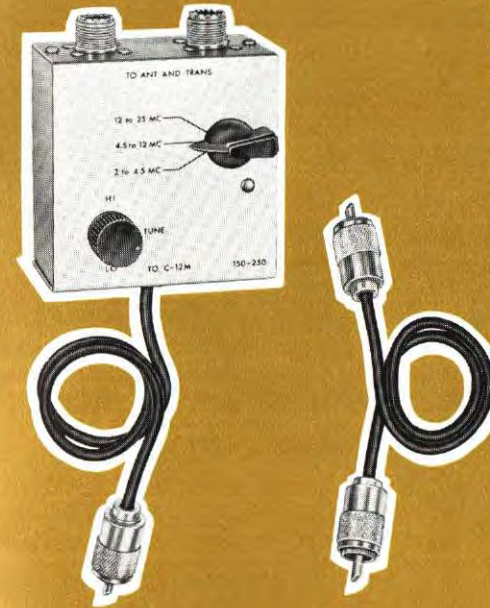

C-12M Frequency meter for marine band servicing

The International C-12M portable secondary standard is a self contained unit designed for servicing radio transmitters and receivers used in the 2 MHz to 15 MHz range. The meter has sockets for 24 crystals. The frequency accuracy IF $\pm .0025\%$ 32°F to 125°F, $\pm .0015\%$ 50°F to 100°F. The C-12M has a built-in transistorized frequency counter circuit, AM percentage modulation checker and modulated carrier

specifications — C-12M

- **Frequency Measurement**
Frequency Range: 2 MHz to 15 MHz. Frequency stability: $\pm .0025\%$ 32°F to 125°F; $\pm .0015\%$ 50°F to 100°F.
- **Counter Circuit**
Frequency range: 0 to 1 KHz and 0 to 500 cps. Residual error of one scale division.
- **AM Modulation Measurement**
Range: 0 to 100%. Accuracy: 3% @ 400 cps @ 80% modulation.

and relative percentage field strength. The unit is supplied with PK (pick-off) box, and connecting cable.

C-12M Frequency Meter, complete with batteries, less crystals. Shipping weight: 9 lbs.

Cat. No. 620-104.....\$235.00

Crystals (specify frequency) See Type CS page 13.

- **RF Signal Generator**
Frequency range: 2 MHz to 15 MHz (modulated approximately 1,000 cps).
- **Battery Power Required**
1½ vdc @ 60 ma. 67½ vdc @ 5 ma. 9 vdc (two).
- **Panel Controls**
Channel selector, 24 positions. "Hi-Lo" frequency adjust. RF level control. Modulation check. Meter calibration adjust. Function selector, 7 positions: Modulation and modulated RF, RF, Deviation 1 KHz full scale (x2), Deviation 500 cps full scale (x1), Calibration, Battery Test "A", Battery Test "B".

Frequency meters



Inline Barrel Attenuator —
(See page 19)

FM-2400CH (25 to 1000 MHz)

FM-2400C (25 to 500 MHz)

The FM-2400CH provides an accurate standard frequency signal for testing and adjustment of mobile transmitters and receivers at predetermined frequencies between 25 and 1000 MHz. (Model FM-2400C 25 to 500 MHz). Up to 24 crystals may be inserted into either model. The frequencies can be those of the radio frequency channels of operation, and/or of the intermediate frequencies of the receivers

between 5 MHz and 40 MHz. Frequency stability (standard) $\pm 0.001\%$ from $+32^\circ$ to $+122^\circ\text{F}$. Frequency stability with built-in thermometer, calibrated crystals and temperature corrected charts, $\pm 0.00025\%$ from $+25^\circ$ to $+125^\circ\text{F}$. ($\pm 0.000125\%$ special 450 MHz crystals available). Unit has solid state circuitry and rechargeable batteries.

specifications

Crystal Oscillator

Frequency Range — 5 to 20 MHz
 Frequency Stability — Standard —
 $\pm 0.0005\%$ from $+50^\circ$ to $+104^\circ\text{F}$
 $\pm 0.001\%$ from $+32^\circ$ to $+122^\circ\text{F}$
 with built-in thermometer —
 $\pm 0.00025\%$ from $+25^\circ\text{F}$ to $+125^\circ\text{F}$
 with crystals calibrated and supplied with temperature corrected charts.
 $\pm 0.000125\%$ $+55^\circ$ to $+95^\circ\text{F}$
 Frequency Tuning — 0.005%

Transmitter Pickup

Frequency Range — 25 to 500 MHz
 Sensitivity — 100,000 μV at 25 MHz to 250,000 μV at 470 MHz across 50 ohms

Counter Circuit

Frequency Ranges — 0 to 1.5 KHz
 0 to 15 KHz
 Residual Error — 100 cps at zero beat

RF Signal Generator

Frequency Range — 25 to 500 MHz
 Low Output — 0.5 to 2 μV across 50 ohms
 High Output — Approximately 500 across 50 ohms
 Crystal and tuning specifications are the same as for the Crystal Oscillator above.

I.F. Signal Generator

Frequency Range — 5 MHz to 20 MHz on Fundamentals, and to 40 MHz on 2nd harmonics
 Frequency Stability — $\pm 0.002\%$ from $+32^\circ$ to $+122^\circ\text{F}$
 Frequency Tuning — None
 Output — 1,000 μV minimum into an open circuit
 4 Nickel-Cadmium rechargeable batteries, charger supplied

Panel Controls

Frequency Channel Selector, 24 positions
 Frequency Adjust, Calibrated 0 to 100
 Function Selector,

- 7 positions — Battery Test "A"
- Battery Test "B"
- Calibration "C"
- RF
- Deviation X.3
- Deviation X1
- Deviation X3

FM-2400CH (meter only).....\$595.00
 FM-2400C (meter only)..... 445.00
 RF Crystals (with temperature correction)..... 24.00 ea.
 RF Crystals (less temperature correction)..... 18.00 ea.
 IF CrystalsCatalog Price

where accuracy counts!



Model 6000 Frequency meter

measures frequencies 10 KHz to 600 MHz with accuracy as close as .000125%

The Model 6000 Frequency Meter consists of a basic portable case containing the batteries, audio frequency circuit, meter, together with the required switches and connectors. Plug-in mixer and oscillator modules complete the unit which measures frequencies from 10 KHz to 600 MHz. Accuracy as close as .000125% can be obtained by using the proper oscillator module. The Model 6000 comes with charger for recharging the nickel cadmium batteries.

The wide variety of oscillator and range modules, make this instrument adaptable to a number of jobs in the field and in the laboratory.

Model 6000 Modular Frequency Meter with 601A Charger, less plug-in modules...\$195.00

The following oscillators are for close tolerance signal generation and have built-in temperature measurement circuits. For use in frequency measurement of trans-

mitters. Oscillators come calibrated with crystal for one frequency.

	Temp Tol 0° - 50°C	Crystal Range	Harmonic Range	
612	.0005%	2-10 MHz	2 to 150 MHz	\$75.00
613	.00025%	10-30 MHz	10 to 400 MHz	75.00
634	.00025%	30-40 MHz	30 to 600 MHz	75.00
634A*	.000125%	30-40 MHz	30 to 600 MHz	90.00

*10°C - 40°C

Range Modules

Each of these units contains the mixer circuit to cover the range shown.

60	10 KHz to 100 KHz.....	\$25.00
61	100 KHz to 10 MHz.....	25.00
62	10 MHz to 100 MHz.....	25.00
63	100 MHz to 400 MHz.....	35.00
64	400 MHz to 500 MHz.....	35.00
65	500 MHz to 600 MHz.....	45.00

Special Modules

611 Oscillator for any frequency 10 KHz to 2 MHz, crystal controlled.....price by quotation

DISCOVER A NEW ERA IN COOKING WITH INTERNATIONAL'S Microwave Oven

The precision crafted International Microwave Oven opens a phenomenal new way to prepare a meal for your family in a matter of minutes. Some food items can be ready to eat in seconds. We invite you to discover a new indispensable tool for fast, easy meals for your family and guests.

In recent years many changes have been taking place in the preparation and availability of frozen foods. Microwave heat is ideal for reheating foods which have been previously cooked. With a selection of either home or commercially prepared precooked and frozen foods you can have meals that offer an infinite variety . . . ready to eat in minutes.

Precooked and frozen foods which normally require 20 to 50 minutes to heat can be ready for the table in 3½ minutes*. The microwave oven will bake potatoes in 5 minutes instead of 60 minutes required in your regular oven. Your family will be amazed and delighted with the time it takes to prepare a snack or complete meal. You can fry crisp bacon in 90 seconds . . . on a paper plate. You can cook "hot dogs" and hot sandwiches in 60 to 90 seconds. A chilled baby bottle takes only 45 seconds. The microwave oven is great for quick after school snacks or when unexpected guests drop by.

no installation required

Your International Microwave Oven is ready to cook the minute you place it on the counter-top. Just connect the plug in an ordinary 115 vac outlet. No special wiring is required.

saves you money!

It costs only pennies to operate . . . three cents an hour to be exact. Since cooking times are in minutes or seconds the operating expense per day is negligible.

technically speaking

The outside dimensions of the International Oven are 23¾ inches wide, 14¾ inches high, and 21¼ inches deep. The available space in

for domestic use

the cooking chamber (cavity) is 11 inches deep, 11¾ inches wide and 8 inches high at the opening. The cavity is somewhat taller, but the top portion is occupied by the stirrer. The cooking cavity is made of brushed stainless steel, and uses an insulated capacitance coupled door seal. All leakage energy outside the oven is well below the U.S. top limit of 1 mw/cm². For safety, the electrical circuit is double interlocked so that all cooking power is removed from the oven cavity when the door is opened.

Power for cooking is supplied by a rugged, long life magnetron. The magnetron is air cooled and operated at a frequency of 2450 MHz.

The power from the magnetron is coupled thru a wave guide to the rear of the cavity. A slow-speed, four-bladed stirrer breaks up the field to produce a more uniform cooking pattern.

With a line voltage of 115 vac (ordinary house power) the International home power oven will draw approximately 20 amperes. The oven should be operated from a circuit fused for 30 amperes.

The home power oven is ideal for the home, mobile home, cruiser, or houseboat equipped with 115 vac dockside or power plant.

service and warranty

Ship-in-factory service with a life time labor warranty and two year parts warranty. During the two years International will pay shipping charges (truck). After two years owner will pay for only shipping charges and parts replaced. The warranty does not cover glass shelf, cavity lights or neglect and abuse by owner.



Available direct from International
\$695⁰⁰ f.o.b. Oklahoma City

*All times may vary with size or number of items in oven.

New Microdek POWER LEAKAGE METER For Microwave Ovens

The International Microdek Model 310 provides a survey meter for measuring energy leakage from microwave ovens. The meter uses a small probe antenna with a detector to pick up leakage energy. The Microdek 310 is ideal for those who use and service microwave ovens. The unit is correlated for leakage from small hole areas as well as wide and narrow slots. The meter reads in two ranges, (a) normal: 10 mw/cm² with useful range 1 mw to 23 mw, (b) 3 mw/cm² with useful range of .4 mw to 6 mw. No batteries are required.

MODEL 310

\$75.00

f.o.b. Oklahoma City

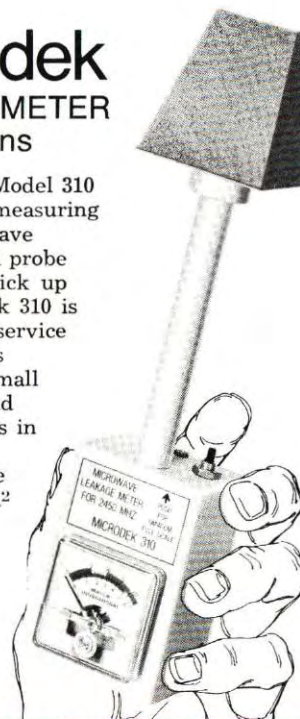

Microlite-287

International's Microlite-287 provides a low cost instrument for testing any microwave energy region. The unit was originally intended for testing the seal area on microwave oven doors. The Microlite-287 will glow when leakage is 10 mw/cm² or above. The same instrument may be used in a laboratory or any area where microwave energy is used and will quickly indicate power leakage. The lamp may be calibrated for other glow levels. The instrument operates on 115 vac and is of a size which stores conveniently in a drawer or tool box.

COMPLETE

\$29.95

f.o.b. Oklahoma City

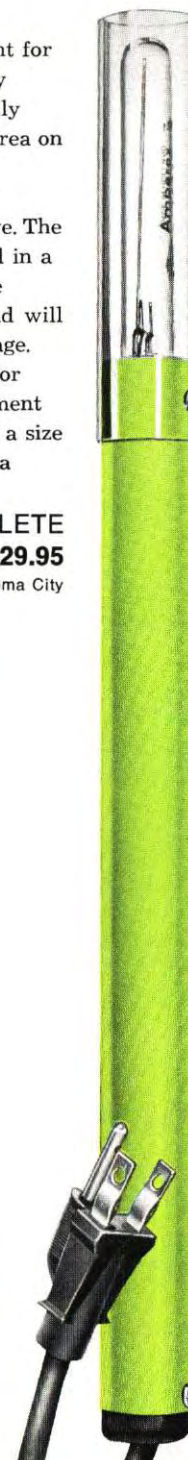
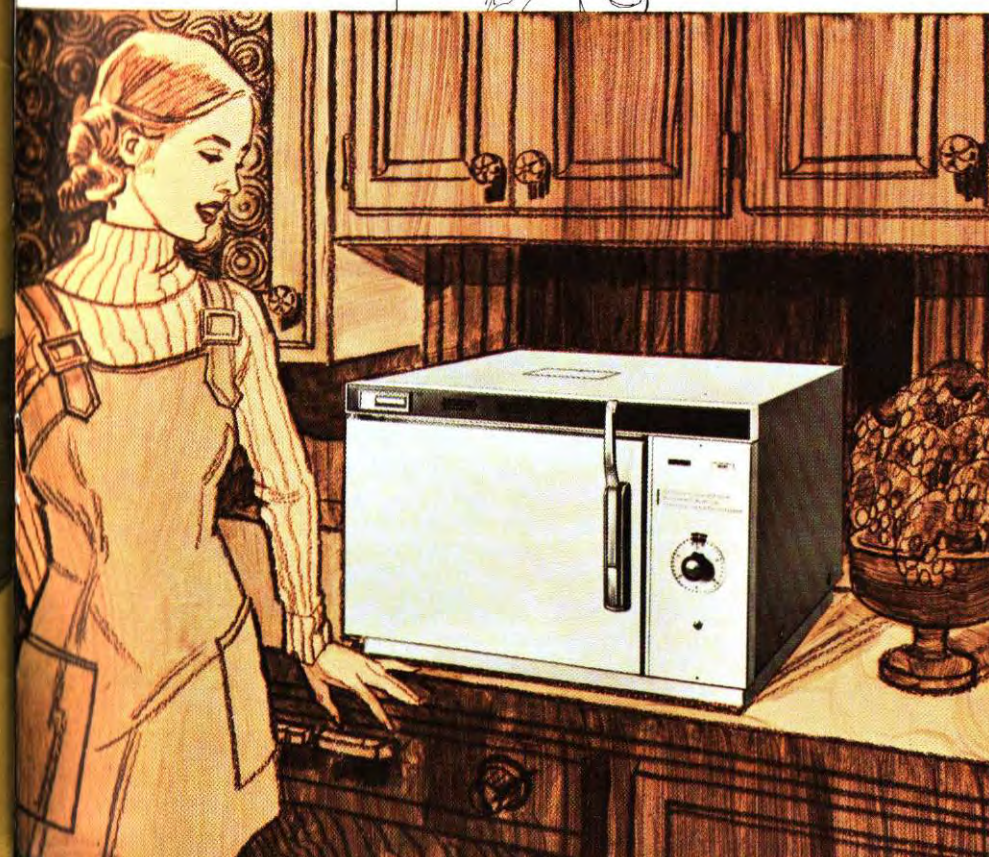



INTERNATIONAL CRYSTAL MANUFACTURING COMPANY, INC.

10 North Lee, Oklahoma City, Oklahoma 73102

If You Didn't Get This From My Site,
Then It Was Stolen From...

www.SteamPoweredRadio.Com