

900C-1



instruction book

Cedar Rapids Division | Collins Radio Company, Cedar Rapids, Iowa

**900C-1()
FM Modulation Monitor**



Guarantee

The equipment described herein is sold under the following guarantee:

Collins agrees to repair or replace, without charge, any equipment, parts, or accessories which are defective as to design, workmanship or material, and which are returned to Collins at its factory, transportation prepaid, provided

- (a) Notice of the claimed defect is given Collins within one (1) year from date of delivery and goods are returned in accordance with Collins instructions.
- (b) Equipment, accessories, tubes, and batteries not manufactured by Collins or from Collins designs are subject to only such adjustments as Collins may obtain from the supplier thereof.
- (c) No equipment or accessory shall be deemed to be defective if, due to exposure or excessive moisture in the atmosphere or otherwise after delivery, it shall fail to operate in a normal or proper manner.

Collins further guarantees that any radio transmitter described herein will deliver full radio frequency power output at the antenna lead when connected to a suitable load, but such guarantee shall not be construed as a guarantee of any definite coverage or range of said apparatus.

The guarantee of these paragraphs is void if equipment is altered or repaired by others than Collins or its authorized service center.

No other warranties, expressed or implied, shall be applicable to any equipment sold hereunder, and the foregoing shall constitute the Buyer's sole right and remedy under the agreements in this paragraph contained. In no event shall Collins have any liability for consequential damages, or for loss, damage or expense directly or indirectly arising from the use of the products, or any inability to use them either separately or in combination with other equipment or materials, or from any other cause.

How to Return Material or Equipment If, for any reason, you should wish to return material or equipment, whether under the guarantee or otherwise, you should notify us, giving full particulars including the details listed below, insofar as applicable. If the item is thought to be defective, such notice must give full information as to nature of defect and identification (including part number if possible) of part considered defective. (With respect to tubes we suggest that your adjustments can be speeded up if you give notice of defect directly to the tube manufacturer.) Upon receipt of such notice, Collins will promptly advise you respecting the return. Failure to secure our advice prior to the forwarding of the goods or failure to provide full particulars may cause unnecessary delay in the handling of your returned merchandise.

ADDRESS:

Collins Radio Company
Service Division
Cedar Rapids, Iowa

INFORMATION NEEDED:

- (A) Type number, name and serial number of equipment
- (B) Date of delivery of equipment
- (C) Date placed in service
- (D) Number of hours of service
- (E) Nature of trouble
- (F) Cause of trouble if known
- (G) Part number (9 or 10 digit number) and name of part thought to be causing trouble
- (H) Item or symbol number of same obtained from parts list or schematic
- (I) Collins number (and name) of unit subassemblies involved in trouble
- (J) Remarks

How to Order Replacement Parts When ordering replacement parts, you should direct your order as indicated below and furnish the following information insofar as applicable. To enable us to give you better replacement service, please be sure to give us complete information.

ADDRESS:

Collins Radio Company
Service Division
Cedar Rapids, Iowa

INFORMATION NEEDED:

- (A) Quantity required
- (B) Collins part number (9 or 10 digit number) and description
- (C) Item or symbol number obtained from parts list or schematic
- (D) Collins type number, name and serial number of principal equipment
- (E) Unit subassembly number (where applicable)



instruction book



900C-1() FM Modulation Monitor

©Collins Radio Company 1964

TBI - 7 IS GROUND
 TBI - 8 IS +5 VDC (at 100% MOD.)
 FOR REMOTE METERING,
 TERMINATE WITH APPROX
 10K TO 12K AT ALL TIMES.
 IF UNTERMINATED, WILL
 MAKE PANEL METER READ HIGH.
 THIS VOLTAGE WILL AGREE
 WITH PANEL METER ON
 MAIN, SUB, PILOT + SCA POSITIONS

962 3980

1900-1901
1901-1902



Instruction book

1900-1901

1901-1902

table of contents

Section		Page
1	GENERAL DESCRIPTION	1-1
1.1	Purpose of Instruction Book	1-1
1.2	Purpose of Equipment	1-1
1.3	Description of Equipment	1-1
1.3.1	Physical Description	1-1
1.3.2	Electrical Description	1-2
1.4	Equipment Supplied	1-2
1.5	Equipment Required but not Supplied	1-2
1.6	Equipment Specifications	1-3
1.6.1	Mechanical	1-3
1.6.2	Electrical	1-3
1.7	Semiconductor and Fuse Complement	1-5
2	INSTALLATION	2-1
2.1	Unpacking	2-1
2.2	Installation Procedures	2-1
2.2.1	Mounting	2-1
2.2.2	External Connections	2-1
2.2.2.1	Power Connections and Change	2-1
2.2.2.2	Input-Output Connections	2-1
2.2.3	Installation Adjustment Procedures	2-1
3	OPERATION.	3-1
3.1	General	3-1
3.1.1	R-F Level Adjustment (900C-1, 900C-1A, 900C-1B, 900C-1C)	3-1
3.1.2	Modulation Meter Calibrate (900C-1, 900C-1A, 900C-1B, 900C-1C).	3-1
3.1.3	Monaural Signal/Noise Ratio Measurements (900C-1, 900C-1A, 900C-1B, 900C-1C)	3-2
3.1.4	AM Noise Measurements (900C-1, 900C-1A, 900C-1B, 900C-1C).	3-2
3.1.5	Frequency Response Measurements (900C-1, 900C-1A, 900C-1B, 900C-1C).	3-2
3.1.6	Distortion Measurements (900C-1, 900C-1A, 900C-1B, 900C-1C).	3-3
3.1.7	Phase Calibrate (900C-1, 900C-1A).	3-3
3.1.8	Stereo Noise Measurements (900C-1, 900C-1A)	3-3
3.1.8.1	Left Channel Noise Measurement	3-3
3.1.8.2	Right Channel Noise Measurement	3-3
3.1.9	Channel Separation (900C-1, 900C-1A)	3-3
3.1.10	Crosstalk Measurements (900C-1, 900C-1A).	3-3
3.1.10.1	Transmit Main Channel, Measure Subchannel Crosstalk	3-3
3.1.10.2	Transmit Subchannel, Measure Main Channel Crosstalk	3-4
3.1.11	Subcarrier Suppression (900C-1, 900C-1A)	3-4
3.1.12	Exciter Pilot Carrier Phasing (900C-1, 900C-1A)	3-4
3.1.13	Pilot Carrier Level Measurement (900C-1, 900C-1A).	3-4
3.1.14	SCA Injection Level Measurements (900C-1, 900C-1B)	3-4
3.2	Normal Operation	3-4
4	PRINCIPLES OF OPERATION.	4-1
4-1	General	4-1

table of contents (cont)

Section		Page
4.2	Block Diagram Discussion	4-1
4.2.1	Monaural Operation	4-1
4.2.2	Stereo Operation	4-2
4.3	Detailed Circuit Discussion	4-2
4.3.1	Monaural Circuits	4-2
4.3.1.1	Mixing and AM Detector Circuits	4-2
4.3.1.2	Pulse Counting Demodulator Circuits	4-5
4.3.1.3	Phase-Splitter and Filter Circuits	4-5
4.3.1.4	Peak Voltmeter Circuit	4-6
4.3.1.5	Peak Light Circuits	4-6
4.3.1.6	Average Voltmeter Circuit	4-6
4.3.2	Stereo Circuits	4-7
4.3.2.1	19-Kc Amplifier-Doubler and 38-Kc Phasing Circuits	4-7
4.3.2.2	Stereo Demodulator and Amplifier Circuits	4-7
5	MAINTENANCE	5-1
5.1	General	5-1
5.2	Transistor Testing Techniques	5-1
5.2.1	Transistor Testing	5-1
5.2.2	Testing PNP Transistors	5-1
5.2.3	Testing NPN Transistors	5-2
5.3	Trouble Shooting	5-2
5.4	Adjustment Procedures	5-2
5.4.1	Test Equipment Required	5-2
5.4.2	Oscillator-Tripler Tuning (900C-1, 900C-1A, 900C-1B, 900C-1C)	5-2
5.4.3	Modulation Meter Calibration Adjustment (900C-1, 900C-1A, 900C-1B, 900C-1C)	5-2
5.4.4	Modulation Polarity Equalizing Adjustment (900C-1, 900C-1A, 900C-1B, 900C-1C)	5-5
5.4.5	Main Channel Modulation Adjustment (900C-1, 900C-1A, 900C-1B, 900C-1C)	5-6
5.4.6	Subchannel Modulation Adjustment (900C-1, 900C-1A Only)	5-6
5.4.7	SCA Modulation Adjustment (900C-1, 900C-1B Only)	5-6
5.4.8	Peak Light Adjustment (900C-1, 900C-1A, 900C-1B, 900C-1C)	5-7
5.4.9	19-Kc Tuning Adjustments (900C-1, 900C-1A Only)	5-7
5.4.10	Pilot Modulation Adjustment (900C-1, 900C-1A Only)	5-7
5.4.11	38-Kc Tank Circuit Tuning (900C-1, 900C-1A Only)	5-7
5.4.12	Stereo Demodulator Adjustments (900C-1, 900C-1A Only)	5-8
6	PARTS LIST	6-1
7	ILLUSTRATIONS	7-1

list of illustrations

Figure		Page
1-1	900C-1() FM Modulation Monitor (C1021-35-P)	1-1
2-1	900C-1() FM Modulation Monitor, Outline and Mounting Dimensions (C1021-05-4)	2-2
2-2	Test Point and Adjustment Locations of Oscillator-Tripler-Mixer A1 (C1021-26-P)	2-5
2-3	Local Oscillator Crystal Location (C1021-36-P)	2-5
3-1	Front Panel Control and Indicator Locations (C1021-39-P)	3-2
4-1	900C-1B and 900C-1C FM Modulation Monitor, Block Diagram (Monaural and SCA) (C1021-15-5).	4-3
4-2	900C-1 and 900C-1A FM Modulation Monitor, Block Diagram (Monaural, Stereo, and SCA) (C1021-02-6)	4-4
4-3	Pulse Counting Demodulator Waveforms with Sine Wave Modulation (C1021-22-3)	4-5
4-4	Stereo Demodulator 19-Kc and 38-Kc Outputs with Phase Changes (C1021-16-3)	4-7
4-5	Elementary Time Division Multiplex System (C1021-17-3).	4-8
5-1	Typical 900C-1() Waveforms (C1021-19-P2).	5-4
5-2	Typical Wide-Band Output Waveforms (C1021-18-P)	5-5
5-3	Factory Adjustment Locations (C1021-14-2)	5-5
5-4	Test Setup for Modulation Meter Calibration Adjustment (C1021-21-3)	5-6
5-5	Test Switch for Obtaining Stereo Signals (C1021-20-3)	5-8
5-6	Test Setup for Stereo Demodulator Adjustments (C1021-23-4)	5-9
6-1	Front View, Parts Location (C1021-34-P)	6-9
6-2	Top View, Parts Location (C1021-37-P).	6-10
6-3	Bottom View, Parts Location (C1021-41-P)	6-11
6-4	Rear View, Parts Location (C1021-40-P)	6-12
6-5	Left Side View, Parts Location (C1021-38-P)	6-13
6-6	Oscillator-Tripler-Mixer A1, Parts Location (C1021-28-P)	6-14
6-7	Pulse Counting Demodulator A2, Parts Location (C1021-25-P)	6-15
6-8	Phase Splitter A3, Parts Location (C1021-30-P)	6-16
6-9	Peak Voltmeter A4, Parts Location (C1021-42-P)	6-17
6-10	Peak Light A5, Parts Location (C1021-33-P).	6-18
6-11	Average Voltmeter A6, Parts Location (C1021-27-P)	6-19
6-12	19-Kc Amplifier A7, Parts Location (C1021-29-P)	6-20
6-13	Amplifier Doubler A8, Parts Location (C1021-32-P)	6-21
6-14	Stereo Demodulator A9, Parts Location (C1021-31-P)	6-22
6-15	Stereo Demodulator A9, Rear View with Shield Removed, Parts Location (C-1021-43-P)	6-23
6-16	Audio Amplifier A10, Parts Location (C1021-24-P).	6-24
7-1	Oscillator-Tripler-Mixer Card A1, Schematic Diagram (1021-01-5)	7-1
7-2	Pulse Counting Demodulator Card A2, Schematic Diagram (C1021-11-4)	7-2
7-3	Phase Splitter Card A3, Schematic Diagram (C1021-09-4)	7-3
7-4	Peak Voltmeter Card A4, Schematic Diagram (C1021-04-4)	7-4
7-5	Peak Light Card A5, Schematic Diagram (C1021-12-4)	7-5
7-6	Average Voltmeter Card A6, Schematic Diagram (C1021-03-4)	7-6
7-7	19-Kc Amplifier Card A7, Schematic Diagram (C1021-06-3)	7-7
7-8	Amplifier-Doubler Card A8, Schematic Diagram (C1021-08-4)	7-8
7-9	Stereo Demodulator Card A9, Schematic Diagram (C1021-07-4)	7-9
7-10	Audio Amplifier Cards A10, A11, Schematic Diagram (C1021-10-4)	7-10
7-11	900C-1() FM Modulation Monitor Chassis, Schematic Diagram (C1021-13-6A) (C1021-13-6B)	7-12

list of tables

Table		Page
1-1	Available Equipment	1-2
1-2	Equipment Supplied for Each 900C-1() Model	1-2
1-3	Diode, Transistor, and Fuse Complement	1-5
2-1	Terminal Strip TB1 Functions	2-3
2-2	Local Oscillator Crystal Frequencies and Part Numbers	2-3
3-1	Control Functions	3-1
5-1	Typical Test Point Voltage Measurements	5-3
5-2	Test Equipment Required for Adjustment Procedures	5-4

general description

1.1 Purpose of Instruction Book.

This instruction book contains the information necessary for installing, operating, and maintaining the 900C-1() FM Modulation Monitor. This instruction book also contains a theory of operation section to be used as an aid in understanding the operation of the modulation monitor.

1.2 Purpose of Equipment.

The Collins 900C-1() FM Modulation Monitor is used to measure transmitter modulation characteristics of a commercial FM broadcast station, monaural or stereo multiplex, operating in the standard frequency

modulated broadcast band of 88 to 108 megacycles. In addition, the 900C-1() may be used as an extremely accurate FM demodulator for driving the station's audio monitors.

1.3 Description of Equipment.

1.3.1 PHYSICAL DESCRIPTION.

The 900C-1() FM Modulation Monitor, shown in figure 1-1, is constructed on a standard 19-inch rack mount and is 19 inches wide, 10-15/32 inches high, 14-15/32 inches deep and weighs approximately 35 pounds depending on equipment type. Individual circuits are constructed on wired circuit cards mounted in a



Figure 1-1. 900C-1() FM Modulation Monitor

SECTION 1
General Description

separate shielded compartment. This compartment is located within the 900C-1() case. Most often used controls are located on the front panel of the 900C-1() with seldom used controls and test points located behind a hinged front panel door. Factory adjustments are located within the monitor dust cover on the lower chassis. The a-c power input and monitor inputs and outputs are located on the rear of the 900C-1() chassis, on individual connectors, or on a rear terminal block.

1.3.2 ELECTRICAL DESCRIPTION.

The 900C-1() is basically a fully transistorized low sensitivity, crystal controlled, superheterodyne, FM monaural or stereo multiplex receiver. Various metering and testing provisions are contained within the modulation monitor to measure transmitter output characteristics. These provisions include a peak modulation light, a peak reading voltmeter, an average reading voltmeter, and methods of reading channel separation and crosstalk (stereo models only), pilot carrier injection level (stereo models only), SCA injection level (SCA models only), left channel audio (stereo models only), right channel audio (stereo models only), main channel audio (stereo models only), subchannel audio (stereo models only), and a metering circuit to set the incoming r-f level. In addition to these functions, the 900C-1() is designed to measure modulation in both positive and negative directions. Outputs obtained from the modulation monitor include a monaural output, a left channel output (stereo models only), a right channel audio output (stereo models only), a distortion meter output, a wide-band audio output, a 19-kc pilot carrier output (stereo models only), and a frequency meter output. Remote monitoring of the 900C-1() may be externally provided for the peak light and the modulation meter, either in a short or a long remote loop.

1.4 Equipment Supplied.

The 900C-1() is available in four different models. Each model consists of a main chassis, optional wired circuit cards placed in the card holder of the main chassis and removeable SCA filters. Addition or deletion of these cards changes the modulation monitor functions. Table 1-1 gives the Collins part numbers for each model and a short description of each. Table 1-2 lists the different models and the wired circuit cards and filters supplied with each.

1.5 Equipment Required but not Supplied.

The 900C-1() FM Modulation Monitor is supplied as a complete unit and requires no external equipment for operation. See section 2 of this instruction book for interconnecting cabling required.

TABLE 1-1
AVAILABLE EQUIPMENT

TYPE	FUNCTION	COLLINS PART NUMBER
900C-1	Contains monaural, stereo, and SCA monitoring functions	522-3275-00
900C-1A	Contains monaural and stereo monitoring functions	522-3483-00
900C-1B	Contains monaural and SCA monitoring functions	522-3484-00
900C-1C	Contains monaural monitoring functions	522-3485-00

TABLE 1-2. EQUIPMENT SUPPLIED FOR EACH 900C-1() MODEL

CIRCUIT CARDS AND FILTERS	COLLINS PART NUMBER	EQUIPMENT TYPE			
		900C-1	900C-1A	900C-1B	900C-1C
Oscillator-Tripler-Mixer A1	528-0430-00	X	X	X	X
Pulse Counting Demodulator A2	528-0431-00	X	X	X	X
Phase Splitter A3	528-0432-00	X	X	X	X
Peak Voltmeter A4	528-0433-00	X	X	X	X
Peak Light A5	528-0434-00	X	X	X	X

TABLE 1-2. EQUIPMENT SUPPLIED FOR EACH 900C-1() MODEL (Cont)

CIRCUIT CARDS AND FILTERS	COLLINS PART NUMBER	EQUIPMENT TYPE			
		900C-1	900C-1A	900C-1B	900C-1C
Average Voltmeter A6	528-0435-00	X	X	X	X
19-Kc Amplifier A7	528-0436-00	X	X		
Amplifier-Doubler A8	528-0437-00	X	X		
Stereo Demodu- lator A9	528-0438-00	X	X		
Audio Amplifier A10	528-0439-00	X	X		
Audio Amplifier A11	528-0439-00	X	X		
Filters FL1, FL2, FL4, FL5		X	X	X	X
Filter FL3		X		X	

1.6 Equipment Specifications.

1.6.1 MECHANICAL.

Size 19 inches wide, 10-15/32 inches high, 14-15/32 inches long (including knobs and rear fuse holder).

Weight:

900C-1 38.5 pounds.

900C-1A 37.7 pounds.

900C-1B 33.4 pounds.

900C-1C 32.6 pounds.

Ambient temperature range 0°C (32° F) to +50°C (+122° F).

Ambient humidity range 0 to 95 percent relative humidity.

Altitude 10,000 ft maximum.

Mounting Standard 19-inch rack panel.

1.6.2 ELECTRICAL.

Power source 100 to 125 volts rms or 200 to 240 volts rms, 50-60 cps.

SECTION 1
General Description

Input power	50 watts maximum.
Frequency range	Any one of 100 FM broadcast channel frequencies from 88 to 108 megacycles.
R-f input impedance	50 ohms, unbalanced.
R-f input voltage range	4 to 10 volts rms.
Oscillator deviation:	
Local	±35 cps, 0°C to +50°C (+32°F to +122°F).
Reference	±50 cps, 0°C to +50°C (+32°F to +122°F).
Intermediate frequency	500 kc.
Modulation meter accuracy	Better than 5 percent modulation at any percentage of modulation up to 133 percent.
Peak modulation indicator	Peak light adjustable to read positive or negative peaks 50 to 120 percent.
Frequency response:	
Monaural	±0.5 db from 50 cps to 15 kc equipped with standard 75-microsecond de-emphasis which can be switched in or out as desired.
Stereo (900C-1 and 900C-1A only)	±1.0 db from 50 cps to 15 kc equipped with standard 75-microsecond de-emphasis which can be switched in or out as desired.
Signal-to-noise ratio:	
Monaural	75 db with 75-microsecond de-emphasis.
Stereo (900C-1 and 900C-1A only)	55 db with 75-microsecond de-emphasis.
Distortion:	
Monaural	0.25 percent maximum, 50 cps to 15 kc, at 100 percent modulation.
Stereo (900C-1 and 900C-1A only)	0.5 percent maximum, 50 cps to 15 kc, at 90 percent modulation.
Channel separation measurement capability (900C-1 and 900C-1A only)	40 db from 50 cps to 15 kc.
Crosstalk measurement capability (900C-1 and 900C-1A only)	45 db main channel to subchannel, 45 db sub-channel to main channel.
Output voltage and impedance:	
Wide band	400 mv peak to peak at 600 ohms, unbalanced.
Monaural audio	0.775 volt rms at 600 ohms, unbalanced (0 dbm).
Stereo audio	0.775 volt rms at 600 ohms, unbalanced (0 dbm).
Distortion meter	10 volts rms at 10,000 ohms, unbalanced.

1.7 Semiconductor and Fuse Complement.

Table 1-3 shows the diode, transistor, and fuse complement of the 900C-1() FM Modulation Monitor.

TABLE 1-3. DIODE, TRANSISTOR, AND FUSE COMPLEMENT

SYMBOL	TYPE	FUNCTION	SYMBOL	TYPE	FUNCTION
OSCILLATOR-TRIPLER-MIXER A1			PEAK VOLTMETER A4 (Cont)		
CR100	1N716A	Voltage limiter	Q253	2N1225	Feedback bias
Q100	2N2380	Mixer	Q254	2N1225	Peak amplifier
Q101	2N2362	Local oscillator	Q255	2N1225	Emitter follower
Q102	2N2362	Tripler	PEAK LIGHT A5		
Q103	2N1225	Reference oscillator	Q300	2N697	Amplifier
PULSE COUNTERING DEMODULATOR A2			Q301	2N1605	One-half pulse generator
CR150	1N270	Switching	Q302	2N1605	One-half pulse generator
CR151	1N270	Triggering	Q303	2N1605	One-half multivibrator
CR152	1N3022A	Voltage limiter	Q304	2N1605	One-half multivibrator
Q150	2N706	One-half pulse generator	Q305	2N697	Switching
Q151	2N706	One-half pulse generator	Q306	2N526	Amplifier
Q152	2N706	One-half multivibrator	Q307	2N526	Buffer
Q153	2N706	One-half multivibrator	AVERAGE VOLTMETER A6		
Q154	2N2380	Buffer	CR350	1N270	Rectifier
PHASE SPLITTER A3			CR351	1N270	Rectifier
Q200	2N1225	Amplifier	CR352	1N270	Rectifier
Q201	2N697	Phase splitter	CR353	1N270	Rectifier
Q202	2N697	Amplifier	Q350	2N1175A	Amplifier
Q203	2N1175A	Amplifier	Q351	2N1225	Amplifier
PEAK VOLTMETER A4			Q352	2N1225	Emitter follower
CR250	1N270	Blocking	Q353	2N1225	Amplifier
CR251	1N270	Clamp	Q354	2N1225	Amplifier
CR252	1N270	Rectifier	AUDIO AMPLIFIER A10, A11 (900C-1 AND 900C-1A ONLY)		
Q250	2N1225	Amplifier	Q400	2N526	Amplifier
Q251	2N1225	Emitter follower	Q401	2N526	Amplifier
Q252	2N1285	Peak detector	Q402	2N526	Amplifier

SECTION 1
General Description

TABLE 1-3. DIODE, TRANSISTOR, AND FUSE COMPLEMENT (Cont)

SYMBOL	TYPE	FUNCTION	SYMBOL	TYPE	FUNCTION
STEREO DEMODULATOR A9 (900C-1 AND 900C-1A ONLY)			19-KC AMPLIFIER A7 (900C-1 AND 900C-1A ONLY)		
CR450	FA4000	Demodulation	Q550	2N526	Amplifier
Q450	2N706	Amplitude correction amplifier	Q551	2N526	Buffer
Q451	2N706	Amplitude correction amplifier	MAIN CHASSIS		
AMPLIFIER-DOUBLER A8 (900C-1 AND 900C-1A ONLY)			CR1	1N830A	Detector
CR500	1N270	Doubler	CR2	1N538	Rectifier
CR501	1N270	Doubler	CR3	1N538	Rectifier
Q500	2N1285	Amplifier	CR4	10M102B1	Voltage limiter
Q501	2N1285	Phase splitter	CR5	1N1124A	Rectifier
Q502	2N1285	Amplifier	FUSE COMPLEMENT		
			F1	1/8 amp	Oven heater protection
			F2	1/2 amp	Demodulator protection

section 2

installation

2.1 Unpacking.

When unpacking the 900C-1(), avoid damaging the equipment through use of careless procedures which could damage the equipment in any way. Inspect all equipment for physical damage immediately after unpacking the equipment. If damage exists, file a claim promptly with the transportation company. Save all packing material for proof of damage claim. Check the equipment against the packing slip to be sure all equipment has been received.

2.2 Installation Procedures.

2.2.1 MOUNTING.

The 900C-1() FM Modulation Monitor is designed to be mounted in a standard 19-inch rack mount. When mounted in a rack, no cooling area need be provided above or below the unit as very little heat is generated by the modulation monitor. However, when the modulation monitor is mounted above high heat generation equipment such as vacuum-tube power supplies, consideration should be given to cooling requirements which allow a free movement of cooler air through and around the 900C-1(). In no instance should the ambient chassis temperature be allowed to rise above 50 degrees C (122 degrees F). An increase above this temperature will cause frequency drifting of the heterodyning crystal resulting in a loss of monitor accuracy.

Mount the 900C-1() to the rack mount panel using eight no. 10 screws and eight no. 10 countersunk finishing washers. Refer to figure 2-1 for an equipment outline and mounting dimension drawing.

2.2.2 EXTERNAL CONNECTIONS.

2.2.2.1 POWER CONNECTIONS AND CHANGE. Power for operation of the 900C-1() is connected to the rear chassis panel through a recessed male connector. A power cable which fastens to this connector is furnished as part of the modulation monitor. Power required for operation is either 115 volts 50 to 60 cps or 220 volts 50 to 60 cps. The 900C-1() as received is connected for 115-volt 50- to 60-cps operation. To convert to 220-volt operation, perform the following procedures:

a. Remove the wire shorting 25-watt resistor R45. This resistor is located in the lower right corner of the chassis.

b. Disconnect wires from transformer T1 which connect terminals 1 to 3 and 2 to 4.

c. Connect a jumper wire from terminal 1 to terminal 4 of transformer T1 to place the two primaries of T1 in series. The 900C-1() is now ready for 220-volt 50- to 60-cps operation.

WARNING

When changed to 220-volt operation, connector J13 located at the rear of the 900C-1() chassis is also changed to 220 volts. Do not connect 115-volt equipment to J13 when the 900C-1() is converted to 220-volt operation.

2.2.2.2 INPUT-OUTPUT CONNECTIONS. Signal connections to the 900C-1() FM Modulation Monitor are made at the rear of the main chassis to either the phono plugs or the terminal strip. In most cases the phono plug outputs are also connected in parallel to the terminal strip connections. The exception to this is the frequency meter output and r-f input. Connections to these points must be run through coaxial cable due to the relatively high frequencies present.

If connections to the phono jacks are used, connect RG-58 coaxial cable to a standard male phono jack. These jacks may be obtained from Collins Radio Company under part number 360-0195-00. When making connections to the terminal strip, use number 22 shielded wire for the monaural, left channel, right channel, and distortion meter outputs. This shielded wire prevents pickup generated by external equipment from being induced in the low level audio output lines.

Terminals 11 and 12 of the rear terminal board are normally connected to a Collins frequency meter. If the Collins frequency meter is not used, jumper terminals 11 and 12 together. This connects the 60-cycle switching voltage from terminal 12 to the MODULATION METER CAL switch. Table 2-1 shows terminal strip TB1 and the functions of each tie point.

2.2.3 INSTALLATION ADJUSTMENT PROCEDURES.

When received, the 900C-1() FM Modulation Monitor is not adjusted to the customer's frequency. To bring the monitor to the customer's frequency, the proper heterodyning crystal must be installed in the monitor and the monitor must be tuned to the new frequency.

SECTION 2
Installation

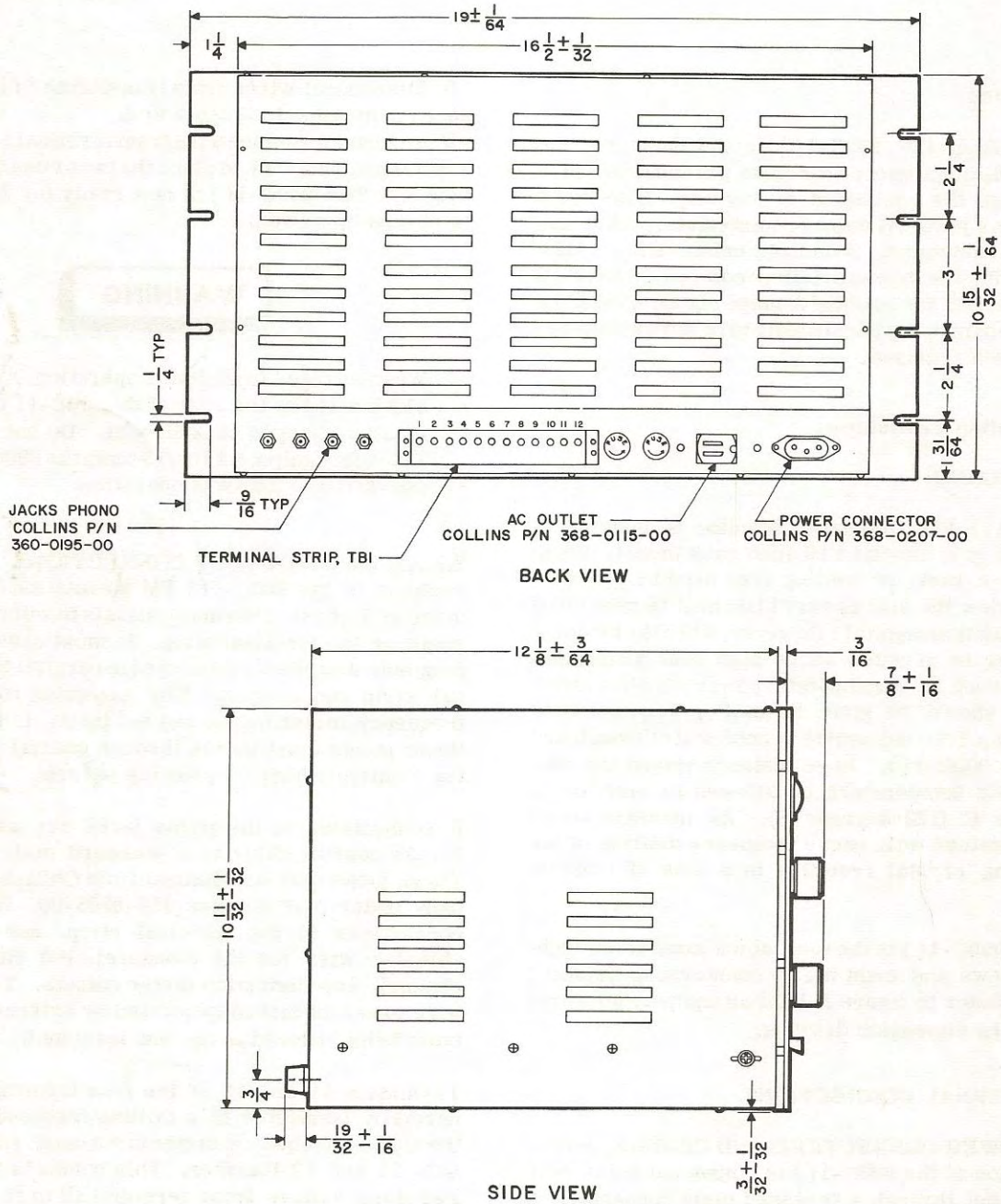

Figure 2-1. 900C-1() FM Modulation Monitor, Outline and Mounting Dimensions

TABLE 2-1
TERMINAL STRIP TBI FUNCTIONS

CONNECTION NUMBER	FUNCTION
1	Monaural output
2	Left audio channel output
3	Ground
4	Right audio channel output
5	Distortion output
6	Local meter output (for remote operation)
7	Ground
8	Peak meter output (for remote operation)
9	Peak light output (for remote operation)
10	36-volt d-c output
11	60-cycle calibration input
12	28-volt a-c output

These same procedures should be followed if the customer's frequency is changed or the monitor is transferred to a station operating at an assigned frequency for which the monitor is not aligned.

Before performing these procedures, the 900C-1() must be completely installed and the transmitter

operating at the authorized power level. The transmitter sampling loop must be set to provide a 4- to 10-volt signal at the monitor input. Refer to figure 2-2 for location of adjustments. Perform the following procedures to align the 900C-1() at the new frequency.

a. Determine the proper crystal operating frequency by referring to table 2-2. Place a crystal whose frequency matches the frequency determined from table 2-2 in the position shown in figure 2-3. Table 2-2 shows each crystal frequency possible for each channel of the FM spectrum and the Collins part number of each.

b. Connect the transmitter monitor output to the modulator monitor r-f input jack. Place the 900C-1() RF LEVEL control to the MIN position.

c. With the transmitter in operation, place the 900C-1() METER switch to the RF LEVEL position and adjust the RF LEVEL control until the meter reads 100 percent.

d. Remove the monitor dust cover and wired circuit card holder cover. Place an oscilloscope between TP-102 (figure 2-2) and ground of the oscillator-tripler-mixer card to observe the 500-kc i-f signal.

e. Adjust C118 (figure 2-2) until an output is observed on the oscilloscope. This indicates that the local oscillator is in operation.

f. Adjust C119 (figure 2-2) until a peak amplitude indication is observed on the oscilloscope.

g. Adjust C118 for a peak amplitude indication on the oscilloscope and then turn C118 an additional 10 degrees towards the low capacity side to improve the oscillator stability. The low capacity side may be observed directly or may be determined by setting the capacitor on the side of the signal peak where the 500-kc signal falls off the least with tuning.

h. Turn the POWER switch to OFF and then back to ON. Observe that the 500-kc i-f signal is present after the power is reapplied. If the oscillator does not start upon reapplying power, adjust C118 for less capacitance until the local oscillator starts.

i. Repeat step h until the local oscillator starts upon applying power.

TABLE 2-2. LOCAL OSCILLATOR CRYSTAL FREQUENCIES AND PART NUMBERS

CRYSTAL FREQ (mc)	CHANNEL FREQ (mc)	COLLINS PART NUMBER	CRYSTAL FREQ (mc)	CHANNEL FREQ (mc)	COLLINS PART NUMBER
29.53333	88.1	289-6220-00	30.20000	90.1	289-6230-00
29.60000	88.3	289-6221-00	30.26666	90.3	289-6231-00
29.66666	88.5	289-6222-00	30.33333	90.5	289-6232-00
29.73333	88.7	289-6223-00	30.40000	90.7	289-6233-00
29.80000	88.9	289-6224-00	30.46666	90.9	289-6234-00
29.86666	89.1	289-6225-00	30.53333	91.1	289-6235-00
29.93333	89.3	289-6226-00	30.60000	91.3	289-6236-00
30.00000	89.5	289-6227-00	30.66666	91.5	289-6237-00
30.06666	89.7	289-6228-00	30.73333	91.7	289-6238-00
30.13333	89.9	289-6229-00	30.80000	91.9	289-6239-00

TABLE 2-2. LOCAL OSCILLATOR CRYSTAL FREQUENCIES AND PART NUMBERS (Cont)

CRYSTAL FREQ (mc)	CHANNEL FREQ (mc)	COLLINS PART NUMBER	CRYSTAL FREQ (mc)	CHANNEL FREQ (mc)	COLLINS PART NUMBER
30.86666	92.1	289-6240-00	33.53333	100.1	289-6280-00
30.93333	92.3	289-6241-00	33.60000	100.3	289-6281-00
31.00000	92.5	289-6242-00	33.66666	100.5	289-6282-00
31.06666	92.7	289-6243-00	33.73333	100.7	289-6283-00
31.13333	92.9	289-6244-00	33.80000	100.9	289-6284-00
31.20000	93.1	289-6245-00	33.86666	101.1	289-6285-00
31.26666	93.3	289-6246-00	33.93333	101.3	289-6286-00
31.33333	93.5	289-6247-00	34.00000	101.5	289-6287-00
31.40000	93.7	289-6248-00	34.06666	101.7	289-6288-00
31.46666	93.9	289-6249-00	34.13333	101.9	289-6289-00
31.53333	94.1	289-6250-00	34.20000	102.1	289-6290-00
31.60000	94.3	289-6251-00	34.26666	102.3	289-6291-00
31.66666	94.5	289-6252-00	34.33333	102.5	289-6292-00
31.73333	94.7	289-6253-00	34.40000	102.7	289-6293-00
31.80000	94.9	289-6254-00	34.46666	102.9	289-6294-00
31.86666	95.1	289-6255-00	34.53333	103.1	289-6295-00
31.93333	95.3	289-6256-00	34.60000	103.3	289-6296-00
31.00000	95.5	289-6257-00	34.66666	103.5	289-6297-00
32.06666	95.7	289-6258-00	34.73333	103.7	289-6298-00
32.13333	95.9	289-6259-00	34.80000	103.9	289-6299-00
32.20000	96.1	289-6260-00	34.86666	104.1	289-6300-00
32.26666	96.3	289-6261-00	34.93333	104.3	289-6301-00
32.33333	96.5	289-6262-00	35.00000	104.5	289-6302-00
32.40000	96.7	289-6263-00	35.06666	104.7	289-6303-00
32.46666	96.9	289-6264-00	35.13333	104.9	289-6304-00
32.53333	97.1	289-6265-00	35.20000	105.1	289-6305-00
32.60000	97.3	289-6266-00	35.26666	105.3	289-6306-00
32.66666	97.5	289-6267-00	35.33333	105.5	289-6307-00
32.73333	97.7	289-6268-00	35.40000	105.7	289-6308-00
32.80000	97.9	289-6269-00	35.46666	105.9	289-6309-00
32.86666	98.1	289-6270-00	35.53333	106.1	289-6310-00
32.93333	98.3	289-6271-00	35.60000	106.3	289-6311-00
33.00000	98.5	289-6272-00	35.66666	106.5	289-6312-00
33.06666	98.7	289-6273-00	35.73333	106.7	289-6313-00
33.13333	98.9	289-6274-00	35.80000	106.9	289-6314-00
33.20000	99.1	289-6275-00	35.86666	107.1	289-6315-00
33.26666	99.3	289-6276-00	35.93333	107.3	289-6316-00
33.33333	99.5	289-6277-00	36.00000	107.5	289-6317-00
33.40000	99.7	289-6278-00	36.06666	107.7	289-6318-00
33.46666	99.9	289-6279-00	36.13333	107.9	289-6319-00

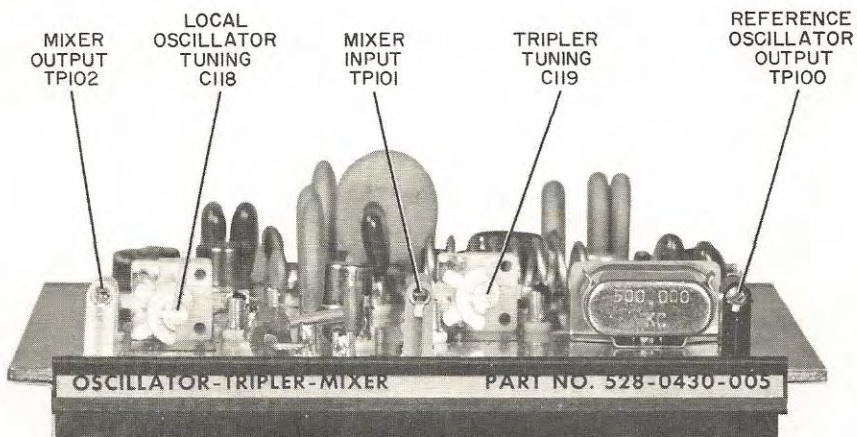

Figure 2-2. Test Point and Adjustment Locations of Oscillator-Tripler-Mixer Card A1

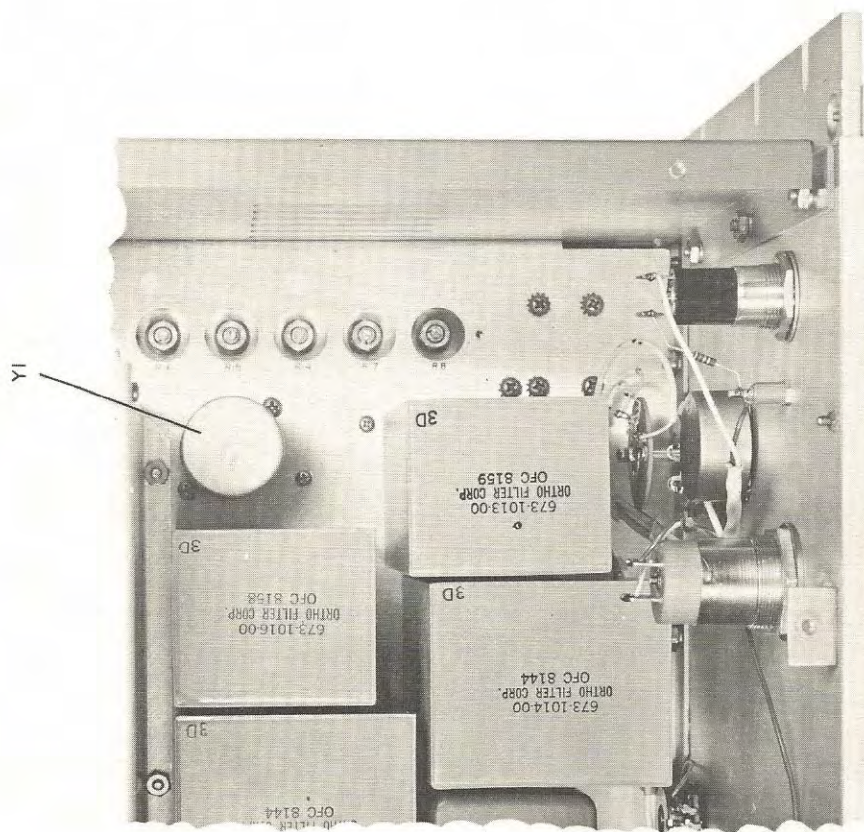
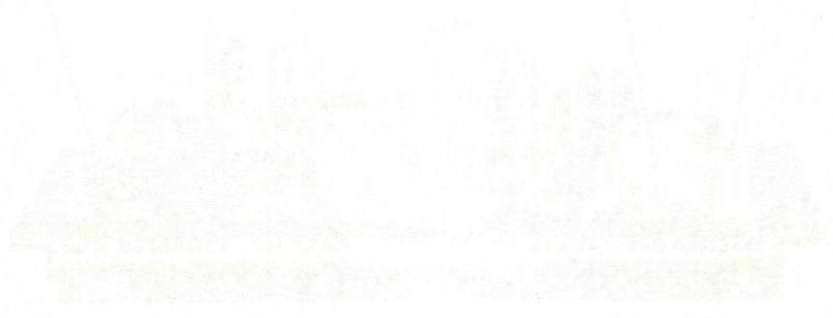

Figure 2-3. Local Oscillator Crystal Location



3.1 General.

The following operating procedures describe methods used to operate each of the possible functions of the 900C-1 FM Modulation Monitor. This monitor contains stereo and SCA provisions. Applicable test procedures for other 900C-1() models are designated by a list of models preceding each procedure. The

first two operating procedures set the level of the incoming r-f signal and calibrate the modulation meter. The remaining procedures are arranged first into monaural monitoring procedures and then stereo calibration and monitoring procedures. Refer to figure 3-1 for location of front panel controls. Table 3-1 gives a brief explanation of the function of each control. Normal operating procedures are given in paragraph 3.2.

TABLE 3-1. CONTROL FUNCTIONS

CONTROL	FUNCTION
DECIBELS switch	Adjusts gain of average voltmeter in 10-db steps.
METER switch	Selects monitoring mode of the 900C-1().
METER ADJUST control	Calibrates the average voltmeter.
POLARITY switch	Selects monitoring polarity of incoming signal.
PERCENT MODULATION control	Selects the percentage of modulation at which the peak light indicates.
MODULATION METER CAL switch and control	Selects the meter calibrate mode and calibrates the peak voltmeter circuits for 100 percent modulation.
SUB CARRIER PHASE CAL switch and control	Switches the monitor circuits to the phase calibrate function and calibrates the monitor 19-kc pilot carrier and subcarrier for proper zero crossing.
DE-EMPHASIS switch	Switches de-emphasis in or out of the monitor circuits.
RF LEVEL control	Adjusts the incoming r-f level to the correct value for AM noise measurement purposes.

3.1.1 R-F LEVEL ADJUSTMENT (900C-1, 900C-1A, 900C-1B, 900C-1C).

a. Set the METER front panel switch to the RF LEVEL position.

b. Adjust the RF LEVEL control located behind the front panel door until the meter reads 100 percent (this equals a 1-volt rms r-f input at the input of the AM detector circuit).



Before applying an r-f input, set the RF LEVEL control to the MIN position.

3.1.2 MODULATION METER CALIBRATE (900C-1, 900C-1A, 900C-1B, 900C-1C).

To calibrate the over-all monitor gain (modulation percentage), perform the following procedures.

SECTION 3
Operation

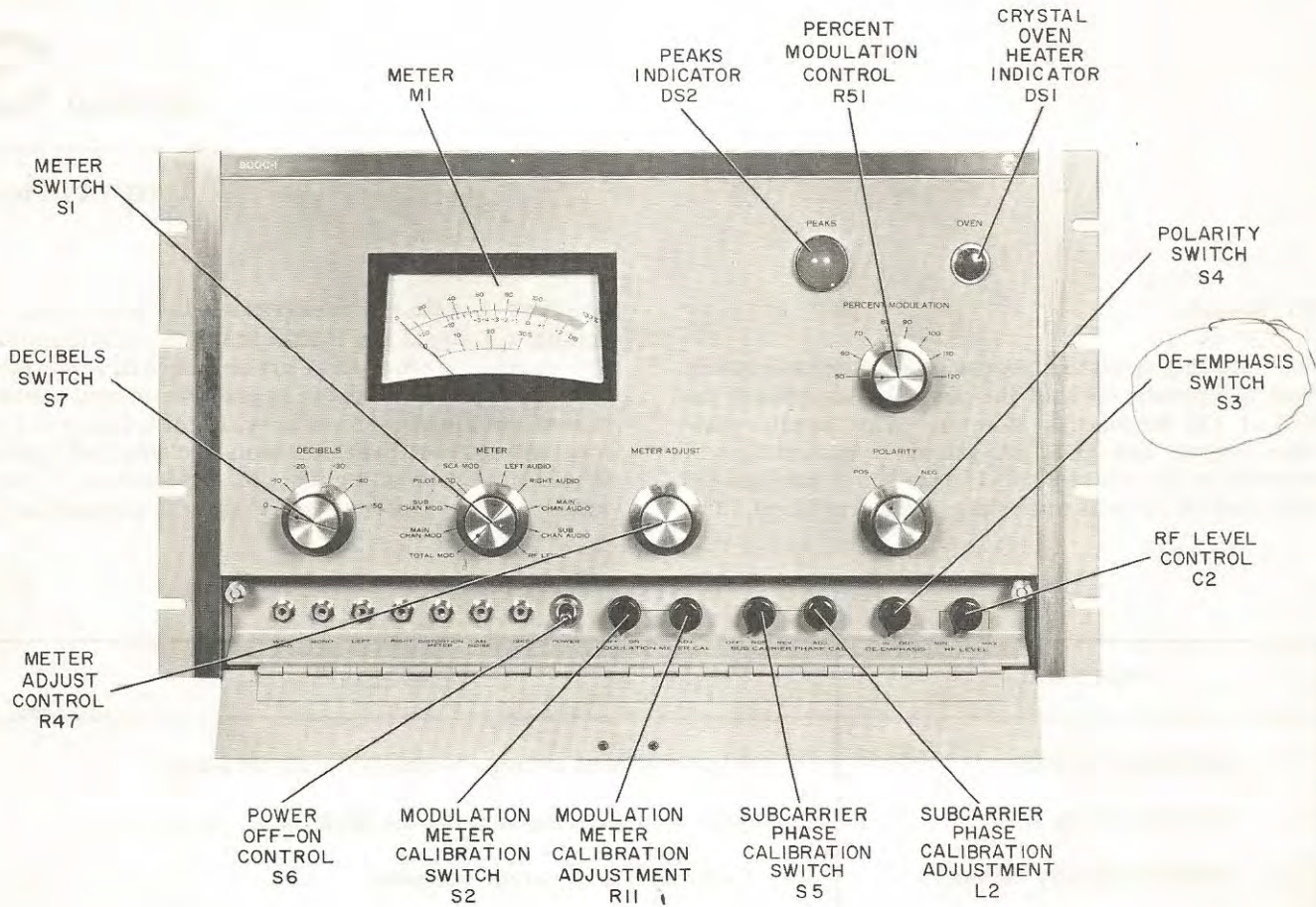

Figure 3-1. Front Panel Control and Indicator Locations

- a. Turn the SUB CARRIER PHASE CAL switch to the OFF position. Turn the METER switch to the TOTAL MOD position.
- b. Turn the MODULATION METER CAL switch to ON and adjust modulation meter calibrate ADJ control until the meter reads 100 percent.
- c. Return the MODULATION METER CAL switch to OFF.

3.1.3 MONAURAL SIGNAL/NOISE RATIO MEASUREMENTS (900C-1, 900C-1A, 900C-1B, 900C-1C).

Perform the following test procedures to measure the monaural signal-to-noise ratio.

- a. Place the METER switch in the TOTAL MOD position and switch the DECIBELS switch to the 0 position.
- b. Apply a monaural, 400-cps signal to the transmitter and modulate 100 percent.
- c. Turn the DE-EMPHASIS switch located on the subpanel to the IN position. Turn the METER switch to the MAIN CHAN AUDIO position and rotate the METER ADJUST control until 0 db is indicated on the front panel meter.

- d. Remove the 400-cps monaural signal and rotate the DECIBELS switch clockwise until an indication is observed on the meter. The monaural signal-to-noise ratio is the algebraic sum of the DECIBELS switch and the meter indication.

3.1.4 AM NOISE MEASUREMENTS (900C-1, 900C-1A, 900C-1B, 900C-1C).

To measure the AM noise present on the transmitted output, perform the following procedures.

- a. Remove all modulation, turn METER switch to RF LEVEL and set r-f level to 100 percent with the RF LEVEL control.
- b. The AM noise may be measured directly by placing an rms reading vtvm on the AM NOISE jack, which is located on the subpanel. The AM noise voltage should be referenced to a carrier level of 1 volt rms.

3.1.5 FREQUENCY RESPONSE MEASUREMENTS (900C-1, 900C-1A, 900C-1B, 900C-1C).

The frequency response of the transmitting equipment may be measured by performing the following procedures.

a. Place the METER switch in the TOTAL MOD position and adjust the transmitter for 100 percent modulation at 400 cps using a signal generator. Monitor the output of the signal generator with a vtm.

b. Change the signal generator frequency to each of the standard FCC modulating frequencies, 50, 100, 400, 1000, 5000, 7500, 10,000 and 15,000 cps, keeping the modulation percentage constant at 100 percent.

c. The vtm indication in db should follow the standard 75-microsecond de-emphasis curve as specified by the FCC.

d. The right and left stereo channels may be measured for frequency response by inserting a right only or left only signal and repeating the frequencies given in step b.

3.1.6 DISTORTION MEASUREMENTS (900C-1, 900C-1A, 900C-1B, 900C-1C).

Channel distortion may be measured using the 900C-1() FM Modulation Monitor by connecting external distortion measuring equipment to the DISTORTION METER jack located on the monitor subpanel. Each channel is measured by rotating the METER front panel switch to a selected position, either the LEFT AUDIO, RIGHT AUDIO, or MAIN CHAN AUDIO position.

3.1.7 PHASE CALIBRATE (900C-1, 900C-1A).

To calibrate the phase of the monitor subcarrier with the 19-kc pilot carrier so exact zero crossing is accomplished, perform the following procedures.

NOTE

Modulation may be applied to the 900C-1() during this procedure.



Be sure that the DECIBELS switch is in the 0 position before turning the SUB CARRIER PHASE CAL switch or damage to the meter may result.

a. Adjust the station's transmitter to transmit a pilot carrier at approximately 10 percent modulation.

b. Turn the SUB CARRIER PHASE CAL switch to the NOR position and note the reading on the meter.

c. Switch the SUB CARRIER PHASE CAL switch to the REV position and again note the meter reading.

d. If a difference exists between the two readings, turn the ADJ control until there is no difference between the readings in the NOR and REV position. When no difference between the readings is noted, the two signals are exactly in phase.

e. Return the SUB CARRIER PHASE CAL switch to the OFF position.

NOTE

This procedure calibrates the modulation monitor 19-kc phase only. Refer to paragraph 3.1.12 for transmitter stereo generator 19-kc phase adjustments.

3.1.8 STEREO NOISE MEASUREMENTS (900C-1, 900C-1A).

3.1.8.1 LEFT CHANNEL NOISE MEASUREMENT.

a. Turn the DECIBELS switch to the 0 position. Adjust the transmitter output for a left channel signal plus pilot carrier (100 percent total modulation at 400 cps).

b. Turn the METER front panel switch to the LEFT AUDIO position. Place the DE-EMPHASIS switch to the IN position. Turn the METER ADJUST control until the front panel meter indicates 0 db.

c. Remove the transmitted left audio signal and rotate the DECIBELS switch until an indication is noted on the meter. The left channel noise is the algebraic sum of the DECIBELS switch and the meter indication.

3.1.8.2 RIGHT CHANNEL NOISE MEASUREMENT. Repeat paragraph 3.1.8.1 substituting left for right and right for left.

3.1.9 CHANNEL SEPARATION (900C-1, 900C-1A).

To measure channel separation with audio applied to the right channel, perform the following procedures.

a. Apply 100 percent modulation left channel only plus pilot carrier from the station transmitter.

b. Place the METER front panel switch in the LEFT AUDIO position.

c. Place the DECIBELS switch in the 0 position and rotate the METER ADJUST front panel control until the meter indicates 0 db.

d. Switch from left channel modulation to right channel modulation and switch the DECIBELS switch in a clockwise direction until an indication is observed on the front panel meter. The channel separation is the algebraic addition of the DECIBELS switch markings and the front panel meter indication.

To obtain channel separation measurements with audio applied to the left channel and measurements taken in the right channel, repeat steps a through d and substitute left for right and right for left where these instructions are indicated.

3.1.10 CROSSTALK MEASUREMENTS (900C-1, 900C-1A).

To measure the magnitude of main and subchannel crosstalk, perform the following procedures.

3.1.10.1 TRANSMIT MAIN CHANNEL, MEASURE SUBCHANNEL CROSSTALK.

a. Turn off the transmitted pilot carrier and SCA signals. Turn the DECIBELS switch to 0.

SECTION 3 Operation

b. Place the METER front panel switch in the TOTAL MOD position and adjust the transmitter for 90 percent modulation with an L = +R signal.

c. Turn the METER switch to MAIN CHAN AUDIO and rotate the METER ADJUST control for 0 db as indicated on the front panel meter.

d. Switch the METER switch to the SUB CHAN AUDIO position and rotate the DECIBELS switch clockwise until an indication is noted on the front panel meter. The crosstalk value in db is the algebraic sum of the DECIBELS switch indication and the meter indication.

3.1.10.2 TRANSMIT SUBCHANNEL, MEASURE MAIN CHANNEL CROSSTALK.

a. Turn off the transmitted pilot carrier and SCA signals. Turn the DECIBELS switch to 0.

b. Place the METER front panel switch in the TOTAL MOD position and adjust the transmitter for 90 percent modulation with an L = -R signal.

c. Do not reset METER ADJUST control.

NOTE

The meter will read approximately 4.5 db low at this time. However the peak value will be calibrated for 0 db.

d. Switch the METER switch to the MAIN CHAN AUDIO position and rotate the DECIBELS switch clockwise until an indication is noted on the front panel meter. The crosstalk value in db is the algebraic sum of the DECIBELS switch indication and the meter indication.

3.1.11 SUBCARRIER SUPPRESSION (900C-1, 900C-1A).

To measure the subcarrier suppression in db, perform the following procedures.

a. Switch the transmitter pilot carrier and SCA off. Turn the DECIBELS switch to 0.

b. Turn the METER front panel switch to TOTAL MOD and apply an L = +R signal to the transmitter. Adjust the transmitter for 90 percent modulation.

c. Turn the METER switch to the MAIN CHAN MOD position and adjust the METER ADJUST control until the meter indicates 0 db.

d. Turn off the L = +R transmitter input and rotate the METER switch to the SUB CHAN AUDIO position.

e. Rotate the DECIBELS switch in the clockwise direction until a meter indication is observed. The subcarrier suppression is the algebraic sum of the meter and DECIBELS switch indication.

3.1.12 EXCITER PILOT CARRIER PHASING (900C-1, 900C-1A).

To bring the stereo generator pilot carrier and stereo subchannel signals exactly in phase, perform the following procedures.

a. Bring the 900C-1() subcarrier and transmitted pilot carrier exactly in phase by performing the steps of paragraph 3.1.7.

b. Modulate the transmitter with an L = -R stereo signal. See figure 5-5 for an example of a test switch for obtaining this type of stereo signal.

c. Place the monitor METER switch to the LEFT AUDIO or RIGHT AUDIO position.

d. Adjust the transmitter stereo generator pilot carrier phase for a maximum indication on the 900C-1() front panel meter.

3.1.13 PILOT CARRIER LEVEL MEASUREMENT (900C-1, 900C-1A).

To measure the level of the transmitted pilot carrier, turn the METER switch to PILOT MOD position and read the output on the 0 to 30 percent scale. This is the pilot carrier output level.

3.1.14 SCA INJECTION LEVEL MEASUREMENTS (900C-1, 900C-1B).

To measure the SCA injection level, perform the following procedures.

a. Feed a normal SCA input into the transmitter.

b. Set the METER front panel switch to the SCA MOD position. Read the SCA level on the 0 to 30 percent scale of the front panel meter.

3.2 Normal Operation.

During normal operation, the 900C-1() METER switch is usually set to the TOTAL MOD position. The meter will then indicate percent of total modulation. The PEAKS light is set to operate at 100 percent modulation. This allows the station operator to check the 900C-1()'s most important function, that of monitoring percent of modulation.

To set the 900C-1() for monitoring percent of modulation, turn the METER switch to the TOTAL MOD position and the PERCENT MODULATION control to 100 percent. The POLARITY switch may be left in either the POS or NEG position. The front panel meter will now indicate the actual percent of transmitter modulation and the PEAKS light will indicate any modulation peaks present over 100 percent.

NOTE

The PEAKS light will indicate only if the meter switch is in the TOTAL MOD position.

principles of operation

4.1 General.

The following discussions describe the operation of the 900C-1() FM Modulation Monitors. As the four types of modulation monitors can be divided into two main groups, monaural and stereo, the following discussions will describe first monaural operation common to all four types of monitors and then stereo functions which are added to the monaural functions. SCA operation is obtained by the addition of SCA filter FL3. The four equipment types are physically similar except for the addition or deletion of certain wired circuit cards and the SCA filter. Refer to table 1-2 for a list of components necessary to make up each equipment type.

4.2 Block Diagram Discussion.

4.2.1 MONAURAL OPERATION.

Refer to figure 4-1. The r-f input obtained from the monitor output of the FM transmitter is fed through an adjustable pad (RF LEVEL control) to an AM detector circuit. The adjustable pad is used to adjust the r-f input level to 1 volt rms to prevent overloading of the monitor input circuits. The AM detector contains a standard 75-microsecond de-emphasis network and provides an AM noise output. This output is fed to the front panel AM NOISE jack and is used for AM noise measurement purposes in conjunction with an external audio vtvm.

The r-f signal from the variable attenuator is further attenuated by a fixed attenuator and is fed to a mixer which combines the incoming r-f signal with the output of a crystal oscillator-tripler operating 500 kc above the incoming signal. The difference signal, a fully modulated FM signal centered about a 500-kc carrier, is fed to demodulation circuits. Switch S2A selects the mixer output or the output of a 500-kc crystal oscillator and connects either to the pulse counting demodulator. This demodulator consists of a pulse shaping stage, a monostable multivibrator, and a phase linear low pass filter, FL4. When switch S2 is in the calibrate position, the 500-kc reference frequency is alternately keyed on and off at a 60-cps rate by a switching diode. This causes a large amplitude 60-cps square wave to appear at the output of the phase linear low pass filter. This square wave is attenuated and is used for calibration of subsequent modulation metering circuits.

When S2 is in the normal operating position, the mixer output is demodulated by the pulse counting demodulator, is fed through a low pass filter, around an 11-db

pad which is used in the calibrate position, to a phase splitter and metering circuits.

The metering circuits consist of wide-band audio amplifiers, a phase splitter, filters, a true peak reading voltmeter, an average reading audio voltmeter, and a peak light flashing circuit. Wide-band audio amplifiers located in the phase-splitter amplify the low level output of the pulse counting demodulator to a usable level. The phase-splitter also is used to select either modulation in the positive (higher frequency) or negative (lower frequency) direction for measurements. This ensures against over-modulation because of the assymetrical nature of the human voice.

An output from the first phase-splitter amplifier stage is fed through a switchable de-emphasis to a monaural output jack. The output is then fed through S1D to an amplifier and transformer which raises the level to 10 volts rms for use by an external distortion analyzer. All harmonics through 45 kc appear unattenuated (except for de-emphasis) at this output.

A second output from the phase splitter is fed, in monaural operation, through a resistance pad (for total modulation measurements), main channel filter (for 30-cps to 15-kc measurements), or an SCA filter (for 59-kc to 75-kc measurements), to either peak voltmeter or average voltmeter circuit. These three circuits provide for selective monitoring of each band of frequencies. The remaining filters are present in the monaural modulation monitor models but are not used. These filters allow for simple conversion to stereo operation with only the addition of wired circuit cards.

An output is taken from the peak voltmeter circuit and is fed to a peak light flasher circuit which causes a lamp to flash when modulation peaks exceed a threshold level set by the PERCENT MODULATION front panel control. This peak modulation must exceed a time duration of 100 microseconds. Connectors are provided for addition of a second remote lamp.

In addition to the true peak reading voltmeter which is used in the percent modulation metering modes, an average reading audio voltmeter is contained in the 900C-1(). This audio voltmeter has adjustable sensitivity which is useful for reading voltage ratios such as those required in signal/noise measurements.

SECTION 4 Principles of Operation

4.2.2 STEREO OPERATION.

The stereo modulation monitor uses the same monaural circuits as described in paragraph 4.2.1 but contains additional circuits which allow monitoring of the complex stereo signal. A block diagram of the stereo modulation monitor is shown in figure 4-2. The following paragraphs discuss only these circuits.

The demodulated, wide-band composite audio modulating signal, containing frequencies between 30 cps and 75 kc from the low pass filter is fed around the calibrating 11-db pad to output jacks for wide-band monitoring purposes and to metering circuits and the stereo demodulator circuits.

The wide-band signal is fed through the same phase splitter as is described in paragraph 4.2.1 and is broken up into separate audio component bands by filters which are selected by METER switch S1. These audio components are the main channel (30 cps to 15 kc), the stereo subchannel (23 kc to 53 kc), the pilot carrier (19 kc), and the SCA channel (59 kc to 75 kc). The pilot carrier filter is part of the stereo demodulator circuit. These filters may be bypassed and total modulation read by selecting the TOTAL MOD position of S1. This is the normal position since total modulation must be monitored continuously. The peak voltmeter circuit responds only to peak values and will read the same regardless of the frequency content of the signal. This is a necessary requirement for stereo and SCA modulation monitoring since both of these modulating signals are complex waveforms.

In the stereo model of the modulation monitor, the average reading voltmeter is used for reading voltage ratios such as signal/noise (used in monaural operation also), channel separation, and crosstalk measurements. This voltmeter can be switched by the METER switch to the output of the main channel filter, the stereo subchannel filter, the left audio output, and the right audio output.

The stereo demodulator circuits consist of the stereo demodulator, subcarrier regeneration circuits, left and right audio amplifiers, left and right audio 15-kc low pass filters, and subcarrier phase calibrating circuits. The wide-band audio signal is fed to a 19-kc amplifier which has two functions; it transforms the wide-band signal source impedance to a low value suitable for driving the stereo demodulator, and to separate the 19-kc pilot carrier for further amplification and doubling to the 38-kc regenerated subcarrier frequency. This high level regenerated subcarrier is fed to the demodulator and causes the incoming composite stereo information to be broken down into left and right audio outputs. An output is taken from the stereo demodulator and is fed to a second 19-kc separator and amplified in the subcarrier phase calibrating circuits for subcarrier phase adjusting purposes. By reversing the 38-kc subcarrier phasing with switch S5 and relay K1, the phasing between

the received pilot carrier and the regenerated subcarrier can be set for optimum stereo demodulation. The left and right audio outputs from the stereo demodulator is fed through two 15-kc low pass filters to two identical audio amplifiers. De-emphasis can be switched in by the same control which switches de-emphasis into the monaural output.

4.3 Detailed Circuit Discussion.

4.3.1 MONAURAL CIRCUITS.

Refer to figures 7-1 through 7-6 and figure 7-11.

4.3.1.1 MIXING AND AM DETECTOR CIRCUITS. The station transmitter monitor output is connected through a coaxial cable to the RFIN jack located at the rear of the modulation monitor. This r-f input signal is normally of too great an amplitude to be used directly by the modulation monitor circuits. The r-f input signal is reduced to a usable level by a variable attenuator, capacitor C2 (RF LEVEL control), which shorts a portion of the signal to ground causing a voltage drop across R2. The remaining signal, an adjusted 1-volt rms r-f signal across C2, is fed to a fixed attenuator and a conventional AM detector circuit. The AM detector circuit consists of diode CR1 and an r-f filter which removes the r-f present below the AM signal. The remaining AM signal is available at the AM NOISE jack for monitoring purposes by an external vtvm.

Diode CR1 in conjunction with front panel meter M1 is also used as a means of monitoring the incoming r-f level. As the diode rectifies the positive half of the FM input signal, the d-c average of this signal is proportional to the input r-f. With the METER switch placed in the RF LEVEL position, the output of CR1 is then placed across meter M1. The r-f input level to the modulation monitor may then be read directly by the front panel meter.

The adjusted 1-volt rms input signal from C2 is fed through a fixed attenuator, R100 and R101, to mixer Q100. Mixer stage Q100 mixes the output from the tripled local oscillator output, which is 500 kc above the transmitter output signal, and the incoming r-f. The resulting 500-kc i-f signal is connected through coupling capacitor C104 to MODULATION METER CAL switch S2.

The local oscillator is crystal controlled with the crystal placed in an oven to produce an extremely stable output frequency. This frequency must be much more stable than the transmitter frequency to ensure measurement accuracy by an externally connected frequency monitor (if used). The output from Q101 is fed through inductor T100 to a grounded base amplifier tripler Q102. The output of Q102 is connected to a tank circuit, C119 and L103, which is tuned to the third harmonic of the oscillator fundamental frequency. Inductance L103 is tapped for proper impedance matching to mixer Q100.

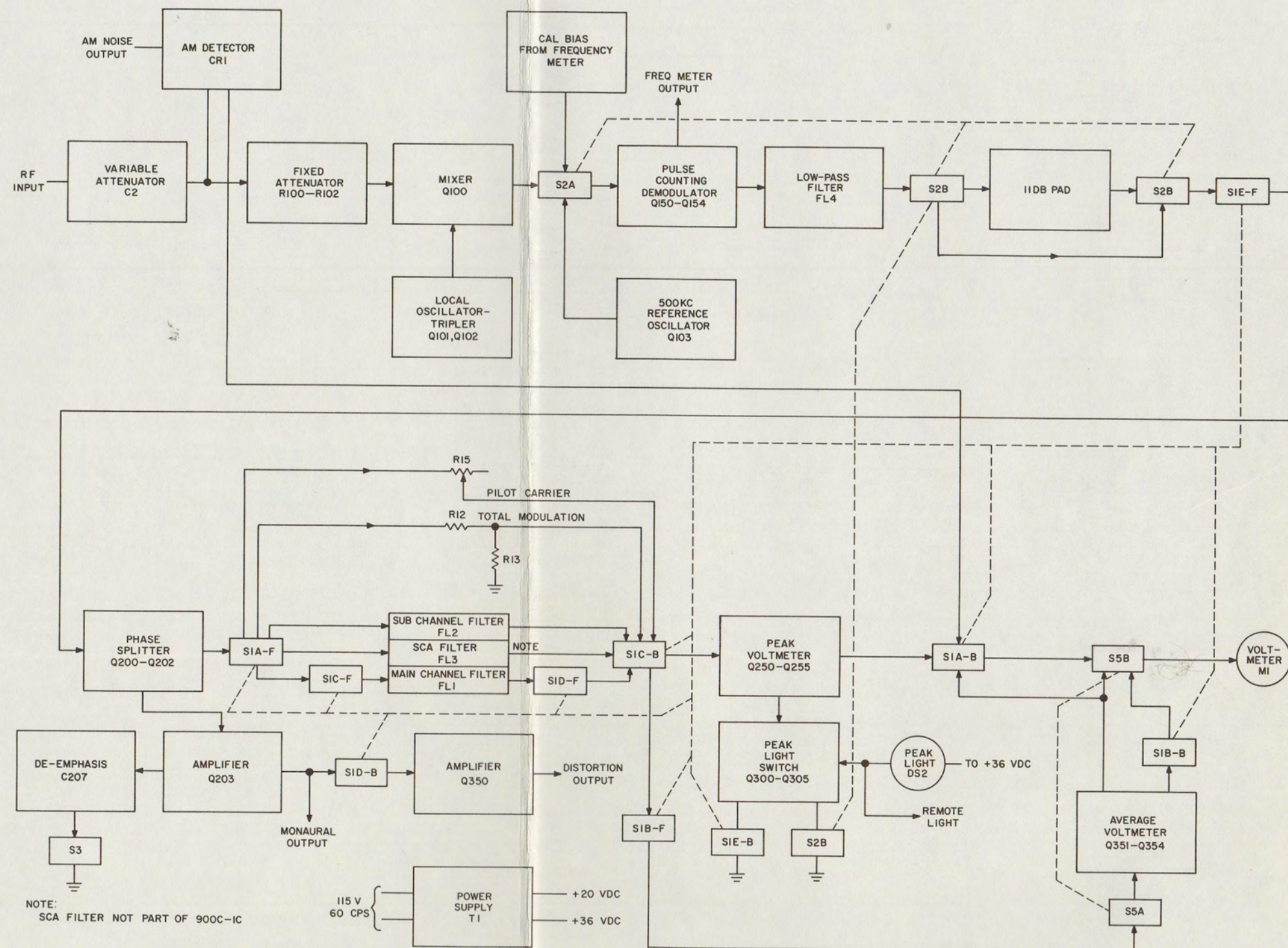
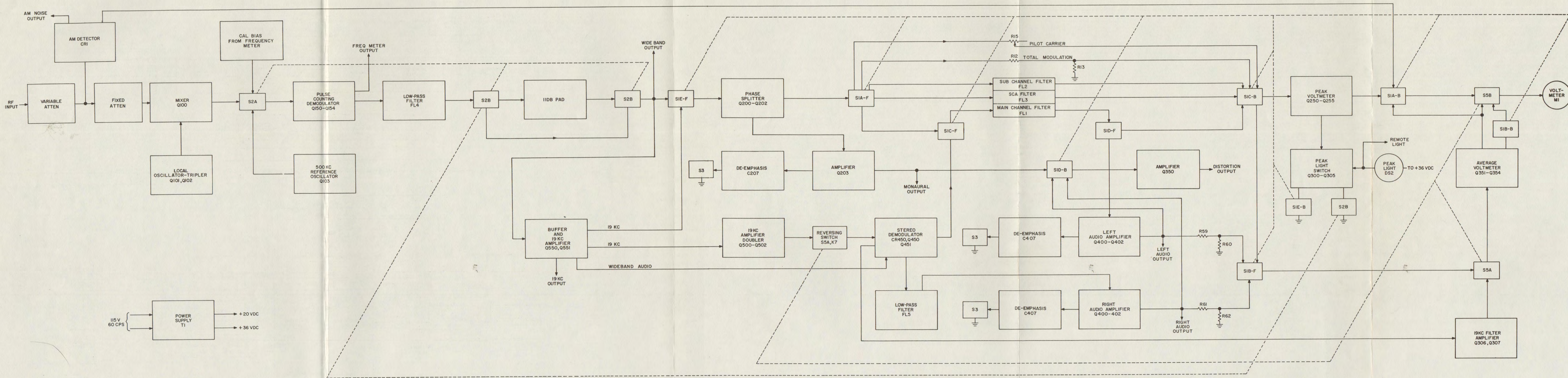

Figure 4-1. 900C-1B and 900C-1C FM Modulation Monitor, Block Diagram (Monaural and SCA)



If You Didn't Get This From My Site,
Then It Was Stolen From...
www.SteamPoweredRadio.Com

Figure 4-2. 900C-1 and 900C-1A FM Modulation Monitor, Block Diagram (Monaural, Stereo, and SCA)

The mixer output is connected to MODULATION METER CAL switch S2. With S2 in the ON position, the output of the reference oscillator, a 500-kc signal from Q103, is switched to the input of pulse generator Q150 and Q151 for calibration purposes. With S2 in the OFF position, the mixer output is connected to the pulse generator input for normal monitoring. Switch S2 also provides a bias voltage to diode switch CR150 to bias the diode on when S2 is in the OFF position. With switch S2 in the ON position a 60-cps switching voltage obtained from the 60-cps 28-volt source, TB1-12, is routed through the external frequency meter to diode CR150. This voltage switches diode CR150 on and off at a 60-cps rate effectively placing a 0- or 500-kc FM signal (500 kc from the reference oscillator) on the pulse generator input (Q150 and Q151) for Modulation meter calibration purposes.

4.3.1.2 PULSE COUNTING DEMODULATOR CIRCUITS. With S2 in the OFF position, the 500-kc mixer output is fed through CR150 to pulse generator Q150. This transistor, in conjunction with Q151, takes the sine wave input FM signal and changes it to a square wave whose polarity follows the input i-f signal polarity and phase. The square wave output of Q151 is then fed to a differentiating circuit consisting of capacitor C153 and R161. This circuit changes the pulse generator square wave output to positive and negative spikes which have leading edges with a sharp rise time. The negative pulses from C153 and R161 are blocked by diode CR151 so only the positive pulse is seen by the base of transistor Q152. Transistors Q152 and Q153 form a single shot multivibrator which produces a pulse with a fixed time length and magnitude each instant a pulse is received through diode CR151. The output from the multivibrator is then a series of pulses with a fixed length and magnitude whose spacing depends upon the incoming frequency. Figure 4-3

shows pictorially how this waveform is obtained from the different circuit locations and the relationship to the incoming r-f frequency. The d-c average voltage or filtered demodulator output is then equivalent to the original FM modulated wide-band transmitter input. The output of the single shot multivibrator is amplified by buffer amplifier Q154 which has an output connected to an external frequency meter and is fed through a phase linear low pass filter. This filter passes all frequencies in the FM modulating spectrum, 0 to 75 kc. The low pass filter averages the pulse output from the pulse counting demodulator to produce audio frequencies from 0 to 75 kc (wide-band audio). With S2 in the OFF position, the filter output is connected through S2 to switch S1E, the 19-kc amplifier discussed in the stereo section of this instruction book, and to the wide-band output jack for external monitoring. Switch S1E, the METER control, switches the wide-band audio from switch S2 to the phase-splitter circuits or, with the METER switch in the PILOT MOD position, switches the 19-kc amplifier output to the phase-splitter circuits. Switch S2 has a final function, to add an 11-db pad in the filter output circuit when S2 is in the ON position. This reduces the output from the pulse counting demodulating circuit to a fixed level for modulation meter calibration.

4.3.1.3 PHASE-SPLITTER AND FILTER CIRCUITS. The phase-splitter circuits consist of an emitter coupled amplifier, Q200, and a conventional amplifier, Q201, which has two outputs of opposite phase but equal amplitude. Switch S4, the POLARITY switch, selects one of these phases and connects the signal to output amplifier Q202. An output is also taken from the collector of Q200 which is fed through power amplifier Q203 to produce a monaural output of sufficient strength to drive external monaural monitoring amplifiers. De-emphasis is switched into the input of Q203 by

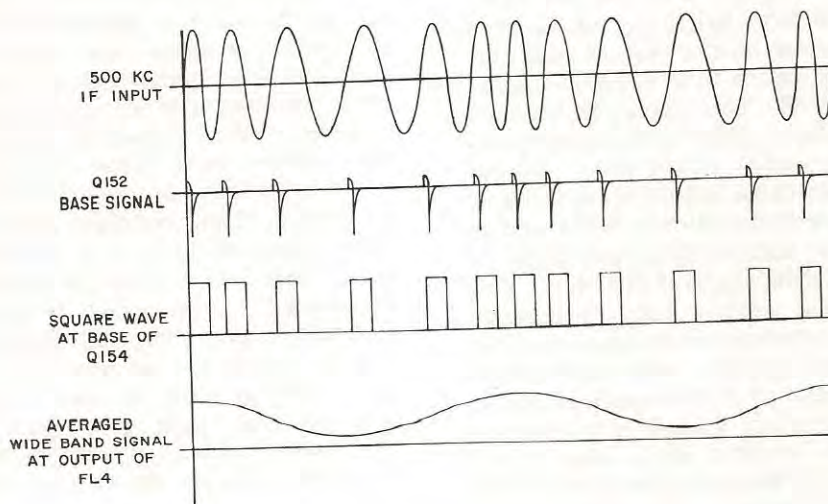

Figure 4-3. Pulse Counting Demodulator Waveforms with Sine Wave Modulation

SECTION 4

Principles of Operation

switching capacitor C207 into the circuit with DE-EMPHASIS switch S4. The output of Q203 is also connected through switch S1D to a second amplifier located in the average voltmeter wired circuit card. This amplifier, Q350, and transformer T2 produce a 10-volt peak-to-peak signal for use by an external distortion analyzer.

The output of Q202 is connected to a series of filter and resistor circuits through METER switch S1. This switch selects which of the incoming wide-band subchannels is to be monitored by the modulation monitor voltmeter circuits. The wide-band audio may be fed around the selective filters for total modulation monitoring and for monitoring the 19-kc pilot carrier. The 19-kc carrier frequency is selected at the input of the phase-splitter circuits.

4.3.1.4 PEAK VOLTMETER CIRCUIT. With METER switch S1 in any of the first five positions, the output of switch S1C is connected to the peak voltmeter circuits. The peak voltmeter circuits are of the automatic slideback peak voltmeter type and are an ideal circuit for determining the peak voltage of the complex waveforms monitored by the 900C-1(). A basic slideback voltmeter operates by reverse biasing a diode to a point where the incoming signal can no longer switch on the diode. The reverse d-c bias voltage is then equal to the incoming peak voltage. The automatic slideback voltmeter operates in a similar manner but operates automatically by taking the signal voltage which is conducted through the reverse biased diode, amplifying the signal, and applying the resultant d-c as a reverse bias to the diode. Signals will cause the diode to conduct until the d-c reverse bias from the amplifiers cuts off diode conduction.

The wide-band complex waveform is amplified by grounded emitter amplifier Q250 and fed to an emitter follower amplifier, Q251. The wide-band signal power is greatly amplified by Q251 with the resulting signal impressed upon peak detector Q252. At the instant that the first half cycle of the input complex waveform appears on the base of Q252, the transistor conducts causing the base signal to appear across load resistor R262. This signal is then fed through coupling capacitor C255 to transistor amplifier Q254 where the signal across load resistor R262 is amplified. The signal output from Q254 is further amplified by emitter follower Q255 and is rectified and clamped by diodes CR252 and CR251 to charge capacitor C257 in the negative direction. Capacitor C257 averages the negative output from diode CR252 into a negative d-c potential which appears at the base of feedback bias switch Q253. With this negative bias present at the base of PNP transistor Q253, the transistor will be heavily biased on increasing the voltage drop across resistor R261. This drives the emitter of Q252 in the negative direction biasing the transistor to the point where only a small signal peak is conducted by Q252. This reduces the signal voltage across load resistor R262 when the succeeding half cycles of the wide-band input waveform arrive at the base of the peak detector transistor. Due to the

gain of transistor stages Q254 and Q255, any conduction of transistor Q252 will cause the voltage at the base of Q253 to be sustained at a level which permits only a very small signal peak to be conducted by Q252. This will occur at a point where the peak wide-band input signal level will cause the peak detector transistor to conduct only for small signal peaks. The voltage present at the collector of Q253 will then be proportional to the peak voltage present in the complex wide-band waveform. This voltage is available at TB1-8 for operation of a remote peak voltmeter and may be connected to the front panel meter through dropping resistor R265 and switch S1A.

4.3.1.5 PEAK LIGHT CIRCUITS. An output from the emitter of Q251 is connected to the input of the peak light circuits. These circuits operate the front panel peak light each time the wide-band waveform exceeds a preset level. This preset level represents a percentage of modulation that must be exceeded by the input waveform before the peak light will operate. The peak light circuits operate as follows. The wide-band audio from the peak voltmeter amplifiers is amplified to a usable level by Q300 and applied to the base of Q301. This transistor is one-half of a pulse generator. The pulse generator firing voltage is controlled by a bias voltage adjusted with the front panel PERCENT MODULATION control. With no wide-band input signal on the base of Q301, the pulse generator circuit is in a condition that causes Q302 to conduct with Q301 nonconducting. With Q302 conducting, the emitter voltage at Q301 is relatively high, ensuring that this transistor will be biased off. The adjustable positive bias voltage at the base of Q301 works against the emitter voltage, increasing or decreasing the emitter-base bias. This emitter-base bias must be exceeded by the input signal voltage before the transistor will conduct.

Conduction of Q301 cuts off transistor Q302 increasing the voltage at the collector of Q302. This voltage increase is differentiated by capacitor C307 to produce a sharp pulse input to Q303 one-half of a single shot multivibrator. Transistor Q304 provides the other half of the multivibrator and furnishes a square wave pulse to transistor switch Q305. The square wave pulse on Q305 causes Q305 to turn on, effectively shorting the collector of Q305 to ground. This switching action turns on the peak light indicator located on the front panel and indicates that the incoming modulation peaks have exceeded the level preset by the PERCENT MODULATION control. The PERCENT MODULATION control is calibrated in modulation percentage, from 50 to 120 percent. A lead attached to the ground side of peak light DS2 may be connected to an external indicator for remote monitoring purposes. This lead places the remote lamp in parallel with DS2.

4.3.1.6 AVERAGE VOLTMETER CIRCUIT. With the METER switch in positions 6 through 9, the average voltmeter circuits and front panel meter are used to monitor the left and right audio channels, main

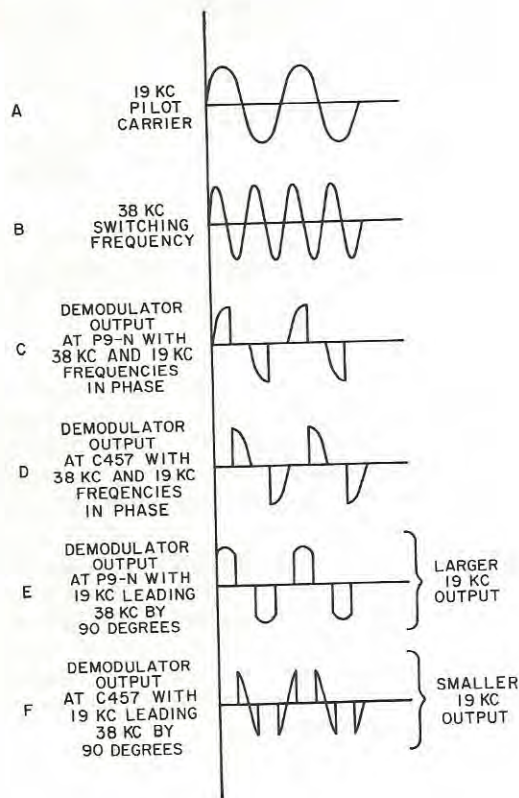

Figure 4-4. Stereo Demodulator 19-Kc and 38-Kc Outputs with Phase Changes

channel audio, and the left channel audio signal levels. These circuits consist of amplifiers and a full wave bridge rectifier and filter which produce a d-c equivalent voltage of the incoming average audio signal level. This d-c voltage is impressed across the front panel meter input for direct reading of incoming levels. The amplifier circuits consist of grounded emitter circuits Q351, Q353, and Q354. Emitter follower Q352 reduces the circuit impedance to a point where addition or deletion of circuit resistance by switch S7 does not affect over-all linearity. Switch S7 increases or decreases the over-all circuit gain in 10-db steps allowing direct measurement of db ratios using the front panel meter.

4.3.2 STEREO CIRCUITS.

Refer to figures 7-7 through 7-11.

4.3.2.1 19-KC AMPLIFIER-DOUBLER AND 38-KC PHASING CIRCUITS. The wide-band demodulated signal, obtained from the pulse counting demodulator, is fed to the base of amplifier Q550 which serves the dual function of a grounded emitter amplifier and emitter follower. The emitter output is connected directly to the stereo demodulator. This circuit will be discussed in later paragraphs. The collector of Q550 is connected to a double tuned resonant circuit. This circuit effectively rejects all other frequencies but the 19-kc pilot carrier frequency present at the amplifier output.

The double tuned 19-kc resonant tank circuits are connected to the base input of an emitter follower buffer amplifier. The buffer amplifier output is connected to the amplifier-doubler circuits, an external output jack for 19-kc monitoring purposes, and to switch S1E which allows the metering circuits to monitor the 19-kc voltage level when the METER switch is in the PILOT MOD position.

The amplifier-doubler amplifies the output from the 19-kc amplifier in Q500 and impresses this amplified signal on the base of phase splitter Q501. As the signal present on the collector and emitter of Q501 are 180 degrees apart, diodes CR500 and CR501 perform the function of a full wave rectifier, effectively doubling the original 19-kc pilot carrier to 38 kc. This 38-kc signal is further amplified by grounded emitter stage Q502 and connected to the input of the stereo demodulator circuits through relay K1. Relay K1 is used to reverse the phase of the 38-kc stereo demodulator switching voltage. By reversing the 38-kc input phase and comparing the 38-kc signal with the 19-kc pilot carrier at the stereo demodulator, proper zero crossing of the 38-kc switching signal will be achieved. Proper zero crossing is indicated by a balance in the voltage observed on the front panel meter each time the SUB CARRIER PHASE CAL control is switched from reverse to normal. A voltage differential occurs across the demodulator diodes because the 19-kc pilot carrier, present at the demodulator wide-band input, increases or decreases in magnitude according to the phase relationship of the 38-kc switching frequency. This relationship is shown in figure 4-4. If the 38-kc and 19-kc frequencies are exactly in phase, the 19-kc pilot carrier voltage at either side of the diode demodulator will be equal (C, figure 4-4). As the phase relationship changes, the pilot carrier voltage across the demodulator diodes will be unbalanced (D and E, figure 4-4). This unbalance is detected by changing the 38-kc switching frequency phase by 180 degrees, thus effectively sampling the 19-kc pilot carrier voltage present on each side of the demodulator diodes.

The sampled 19-kc signal from stereo demodulator diode CR450 is amplified by transistor stages Q306 and Q307 when the SUB CARRIER PHASE CAL control is in the REV or NOR position. Transistor stages Q306 and Q307 along with the associated resonant circuits restore the sine wave symmetry to the 19-kc signal and also amplify the signal. The output of Q307 is connected to the average voltmeter through S5. The average voltmeter circuits then indicate through the front panel meter the magnitude of 19-kc pilot carrier signal present at the stereo demodulator.

4.3.2.2 STEREO DEMODULATOR AND AMPLIFIER CIRCUITS. The stereo demodulator circuits separate the original left and right audio channels from the wide-band composite signal. This demodulation is accomplished by alternately switching the incoming wide-band composite stereo at the 38-kc suppressed

SECTION 4
Principles of Operation

carrier rate. The switching is accomplished in diode CR450. This diode is composed of four diodes arranged as a shunt type demodulator. As the original transmitted stereo signal is composed of alternate switching of the left and right audio channels at a 38-kc rate (time division multiplex system, figure 4-5), demodulation is accomplished by the reverse method.

The outputs from the diode shunt demodulator, left and right audio channels, are fed to amplitude correction amplifiers Q450 and Q451. The left audio channel is fed to Q450, the right audio channel to Q451. The amplitude correction amplifiers correct for the fact that the signal was transmitted with equal peak amplitude main and subchannel signals rather than a signal which consists of a subchannel signal which is $\frac{4}{\pi}$ times the main channel signal. This latter signal could be demodulated without an amplitude correction. The amplitude correction amplifier outputs are fed through 0- to 15-kc low pass filters (FL1 and FL5) which remove all frequencies present on the demodulated audio above 15 kc.

The outputs of filters FL1 and FL5 are fed through identical audio amplifiers which increase the

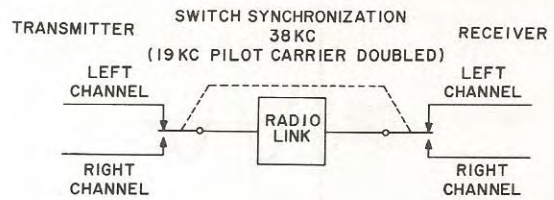

Figure 4-5. Elementary Time Division Multiplex System

demodulated left and right audio channels to a usable level. These amplifiers consist of Q400 through Q402. The final amplifier, Q402, is an emitter follower which reduces the output impedance to approximately 600 ohms at the output terminals of TB1. The front panel METER switch can select either the left or right audio output of Q402 and connect either to the average voltmeter input. The average voltmeter (discussed in the monaural section) and front panel meter may then measure channel separation, crosstalk, channel noise, frequency response, or channel distortion measurements of the demodulated left and right audio channels.

5.1 General.

The following paragraphs contain information concerning maintenance of the 900C-1() FM Modulation Monitor.

5.2 Transistor Testing Techniques.

The 900C-1() FM Modulation Monitor is a completely transistorized equipment. The following transistor testing techniques are supplied for the purpose of acquainting the person unfamiliar with transistor servicing with general transistor testing techniques.

NOTE

All transistors are placed in sockets to facilitate testing and repair. If a transistor is removed from its socket, replace the transistor in the socket with transistor tab located adjacent to the black dot printed near the transistor socket.

CAUTION

When performing maintenance on the 900C-1() do not interchange transistors. Interchange may cause calibration errors.

5.2.1 TRANSISTOR TESTING.

If a transistor tester is not available, a good ohmmeter may be used for testing. The results will not be conclusive, but a general indication of transistor condition will be obtained. Do not use an ohmmeter from which high currents could be obtained, or transistors may be damaged.

Ohmmeter test lead polarity must be established before testing transistors as junction resistance is measured in each direction. In most multimeters, the positive ohmmeter lead is the COM lead, and the V/A lead is negative. In other models of multimeters, this may be reversed.

To test transistors properly, they should be removed from the circuit to eliminate shunt resistances or clamping diodes. If it is impossible to remove the transistor from the circuit, examine the power supply schematic, and determine the approximate total shunt resistance bridging the two transistor elements to be checked. Take this resistance into account when performing the following steps.

5.2.2 TESTING PNP TRANSISTORS.

The resistance values stated in the following steps are approximate, and will vary over a wide range with different transistor types and different ohmmeters. The important observations to be made are the ratio of resistance indications when the ohmmeter leads are reversed, the open circuit indication, and a short circuit indication. In general, the resistance indications at the high end of the ranges given apply to small-signal transistors, while the resistance indications at the low end of the ranges given apply to large-signal or power transistors.

- a. Connect the positive lead of the ohmmeter to the emitter, the negative lead to the base. Ohmmeter indication should be approximately 50 to 150 ohms.
- b. Connect the positive lead of the ohmmeter to the base, the negative lead to the emitter. Ohmmeter indication should be approximately 30,000 to 60,000 ohms. If the absolute value of resistances read differs greatly from the values above, check that the ratio of resistances is on the order of 500-to-1 or greater. Indications with large variations from the above probably indicate a defective transistor.
- c. Connect the positive lead of the ohmmeter to the collector, the negative lead to the base. Ohmmeter indication should be approximately 50 to 160 ohms.
- d. Connect the positive lead of the ohmmeter to the base, the negative lead to the collector. Ohmmeter indication should be approximately 30,000 to 60,000 ohms. If the absolute value of the resistances read differs greatly from the values above, check that the ratio of resistances is on the order of 200-to-1 or greater. Indications with large variations from the above probably indicate a defective transistor.
- e. Connect the positive lead of the ohmmeter to the emitter, the negative lead to the collector. Ohmmeter indication should be approximately 100 to 7000 ohms.
- f. Connect the positive lead of the ohmmeter to the collector, the negative lead to the emitter. Ohmmeter indication should be approximately 5000 to 60,000 ohms. If the absolute value of the resistances read differs greatly from the values above, check that the ratio of resistances is on the order of 8-to-1 or greater. Indications with large variations from the above probably indicate a defective transistor.
- g. Connect the positive lead of the ohmmeter to the emitter, the negative lead to the base and collector. Ohmmeter indication should be approximately 5000 to 60,000 ohms.

h. Connect the positive lead of the ohmmeter to the emitter, the negative lead to the base and collector. Ohmmeter indication should be approximately 100 ohms. If the absolute value of the resistances read differs greatly from the values above, check that the ratio of resistances is on the order of 200-to-1 or greater. Indications with large variations from the above probably indicate a defective transistor.

5.2.3 TESTING NPN TRANSISTORS.

The tests for NPN transistors are identical to those for PNP transistors in paragraph 5.2.2 except that the polarity of the ohmmeter voltage is reversed for all parts of all checks. Indicated resistances and resistance ratios are the same.

5.3 Trouble Shooting.

Trouble shooting is facilitated through the use of the card extender located beneath the card cage cover. With the circuit card mounted on the card extender and the extender replacing the position of the circuit card, the components located on the card are easily available for in-circuit testing. All cards may be mounted in this way for in-circuit testing with the exception of the oscillator-tripler-mixer card. Due to the frequencies generated and fed into this card, it is necessary to keep the interconnecting leads as short as possible or serious circuit losses will result. The resulting losses will cause apparent equipment malfunctions. The tuning tool located at the left end of the card cage is included for tuning of the oscillator inductances located on the oscillator-tripler-mixer card.

Trouble-shooting procedures of the 900C-1() will consist of isolating the trouble to a stage and then making resistance measurements of the isolated stage until the trouble source is found. Test points are located on each circuit card for the purpose of aiding the technician in this trouble isolation. These test points are usually located on the input and output of each card and in certain instances, at intermediate locations. Table 5-1 is provided in this section to show the voltage expected at each test point and the conditions in which each measurement was taken. These voltages are typical only and do not represent absolute values. Other modulation monitors may contain voltages which vary slightly from those values given with no loss of performance.

Figure 5-1 is included to show the expected waveforms present at various points throughout the 900C-1(). Only significant waveforms are given.

Figure 5-2 shows the waveforms that are present at the wide-band output jack for each of the three types of stereo modulation and with L=R modulation without pilot carrier. These waveforms are present only with sine wave modulation.

5.4 Adjustment Procedures.



The following procedures show how to adjust the factory adjustments located below the protective cover (figure 5-3). These adjustments have been made at the factory to optimize the performance of the modulation monitor. Under no circumstances should the following adjustments be made without first determining that the source of trouble is positively caused by one of these adjustments. Indiscriminate adjustment or adjustment without the high quality test equipment recommended will result in serious loss of equipment performance.

5.4.1 TEST EQUIPMENT REQUIRED.

Table 5-2 gives the equipment necessary to perform the adjustment procedures. The equipments given in the table or equivalent equipment of the same high quality must be used in these procedures.

5.4.2 OSCILLATOR-TRIPLER TUNING (900C-1, 900C-1A, 900C-1B, 900C-1C).

Perform the procedures as given paragraph 2.2.3, steps b through i.

5.4.3 MODULATION METER CALIBRATION ADJUSTMENT (900C-1, 900C-1A, 900C-1B, 900C-1C).

- a. Connect the modulation meter to the test equipment as shown in figure 5-4.
- b. Turn the monitor RF LEVEL control to the MIN position.
- c. Connect a dummy load to the antenna connection and turn on the station transmitter. Set the incoming r-f level by switching the monitor METER switch to the RF LEVEL position. Adjust the RF LEVEL control for a front panel meter scale reading of 100.
- d. Turn the METER switch to the TOTAL MOD position.
- e. With no transmitter modulation, tune in the frequency translator output frequency on the communications receiver.

NOTE

If a Collins A830-2 Wide Band FM Broadcast Exciter is used in the station's transmitter, it will not be necessary to use the frequency translator. Connect a pickup loop from the communications receiver antenna to the area of Q606 on the A830-2. Tune the communications receiver for 14 megacycles to receive the A830-2 i-f signal.

TABLE 5-1. TYPICAL TEST POINT VOLTAGE MEASUREMENTS

TEST POINT	INDICATION *(volts a-c)	CONDITIONS
TP100	1.5	MODULATION METER CAL switch ON, no modulation, carrier only
TP101 (1)	0.24	No r-f input (MODULATION METER CAL switch OFF)
TP101 (2)	0.68	R-f input, carrier only, no modulation
TP102	0.5 (min)	Same as TP101 (2)
TP150	0.5 (min)	Same as TP101 (2)
TP151	3.2	Same as TP101 (2)
TP200	0.13	Carrier modulated 100% with 400-cps monaural signal
TP201	0.45	Same as TP200
TP250	0.46	Same as TP200
TP251	0.94	Same as TP200
TP252	0.074	Same as TP200
TP300	0.94	Same as TP200
TP301	0.08	Carrier modulated 100% with 400-cps stereo L=R signal, SUB CARRIER PHASE CAL switch to NOR
TP302	0.042	Same as TP301
TP350	0.088	Carrier modulated 100% with 400-cps monaural signal, METER switch to MAIN CHAN AUDIO
TP351	1.9	Same as TP350
TP400	0.0285	Carrier modulated 100% with 400-cps stereo L=R signal
TP401	0.775	Same as TP400
TP450	0.044	Same as TP400
TP451	0.044	Same as TP400
TP500	0.08	Same as TP400
TP501	7.4	Same as TP400
TP550	0.12	Same as TP400
TP551	0.12	Same as TP400

*Voltages are a-c only. Test points TP100 through TP151 voltage measured with Hewlett-Packard 410B. Test points TP200 through TP551 voltages measured with Hewlett-Packard 400D.

TABLE 5-2. TEST EQUIPMENT REQUIRED FOR ADJUSTMENT PROCEDURES

EQUIPMENT TYPE	FUNCTION
Hewlett-Packard 200DC	A-f signal generator
Hewlett-Packard 330D	Distortion and noise meter
Hewlett-Packard 400L, D, or H	Audio vtvm
Hewlett-Packard 410B	Vtvm
Hewlett-Packard 524D	Frequency counter
Tektronix 545A	Oscilloscope
Tektronix Type D Plug-in Unit	Vertical amplifier
Collins 75S-3	Communications receiver
-----	Frequency translator (Not used if Collins A830-2 is available)

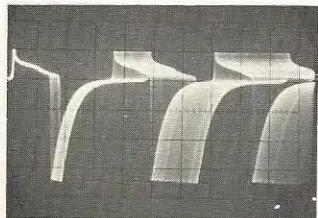

PULSE GENERATOR OUTPUT
AT R161 WITH 400CPS
100% MODULATION,
SWEEP TIME 0.5MS/CM,
VOLTAGE 2V/CM

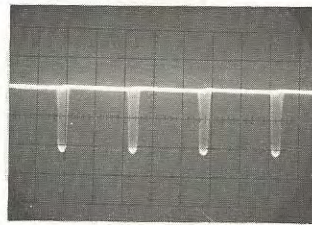

PEAK AMPLIFIER OUTPUT
AT COLLECTOR OF Q255
WITH LEFT ONLY 100% MODULATION
+ PILOT CARRIER, SWEEP TIME 1MS/CM,
VOLTAGE 0.5V/CM

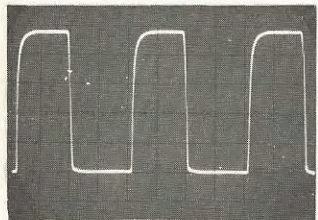

Q153 COLLECTOR OUTPUT,
NO MODULATION, CARRIER ONLY,
SWEEP TIME 0.5MS/CM,
VOLTAGE 2V/CM

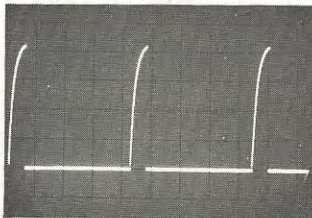

PEAK LIGHT PULSE GENERATOR
OUTPUT AT COLLECTOR OF Q255
WITH 400CPS 100% MODULATION,
SWEEP TIME 5MS/CM,
VOLTAGE 5V/CM

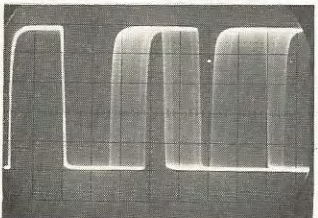

Q153 COLLECTOR OUTPUT,
400CPS 100% MODULATION,
SWEEP TIME 0.5MS/CM,
VOLTAGE 2V/CM

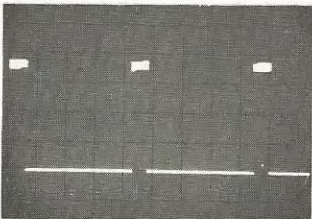

PEAK LIGHT SWITCH PULSED ON TIME
(LOWER LINE OF SQUARE WAVE),
AT COLLECTOR OF Q305,
SWEEP TIME 5MS/CM,
VOLTAGE 5V/CM

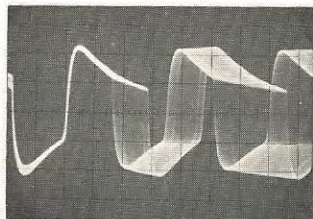

PULSE COUNTING DEMODULATOR OUTPUT
AT TP151, 400CPS 100% MODULATION,
SWEEP TIME 0.5MS/CM,
VOLTAGE 2V/CM

Figure 5-1. Typical 900C-1() Waveforms

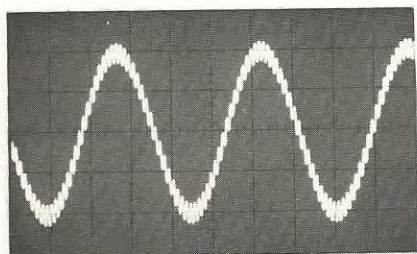

L=R +PILOT CARRIER

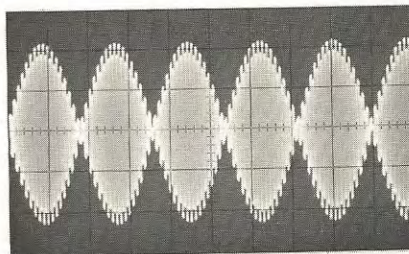

L=-R +PILOT CARRIER

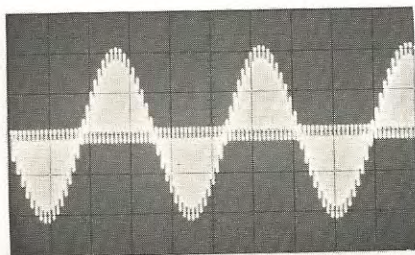

LEFT CHANNEL ONLY
+PILOT CARRIER

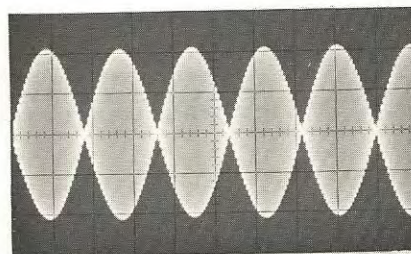

L=-R WITHOUT PILOT CARRIER

Figure 5-2. Typical Wide-Band Output Waveforms

f. Adjust the output of the audio generator 8667 cps as indicated on the frequency counter.

g. Reduce the audio generator output to 0 volt.

h. While observing the communications receiver S-meter, slowly increase the audio generator output voltage. As the level is increased, the transmitter carrier indicated on the S-meter will disappear suddenly. Continue increasing the audio generator output voltage until the third carrier disappearance is indicated on the S-meter. This is the 100 percent modulation point.

i. Place the MODULATION METER CAL switch in the OFF position and the POLARITY switch in the NEG position. Adjust the monitor front panel meter reading for exactly 100 by adjusting the MODULATION METER CAL control.

j. Place the MODULATION METER CAL switch in the ON position.

k. If exactly 100 percent modulation is not indicated on the front panel meter, adjust R8 for an exact 100 percent indication.

l. Remove test equipment from the monitor. Shut down the transmitter.

5.4.4 MODULATION POLARITY EQUALIZING ADJUSTMENT (900C-1, 900C-1A, 900C-1B, 900C-1C).

a. Place the POLARITY switch in the POS position and switch the MODULATION METER CAL switch to the ON position.

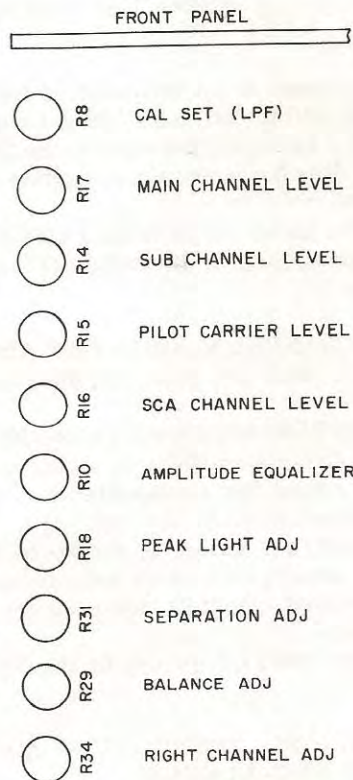

Figure 5-3. Factory Adjustment Locations

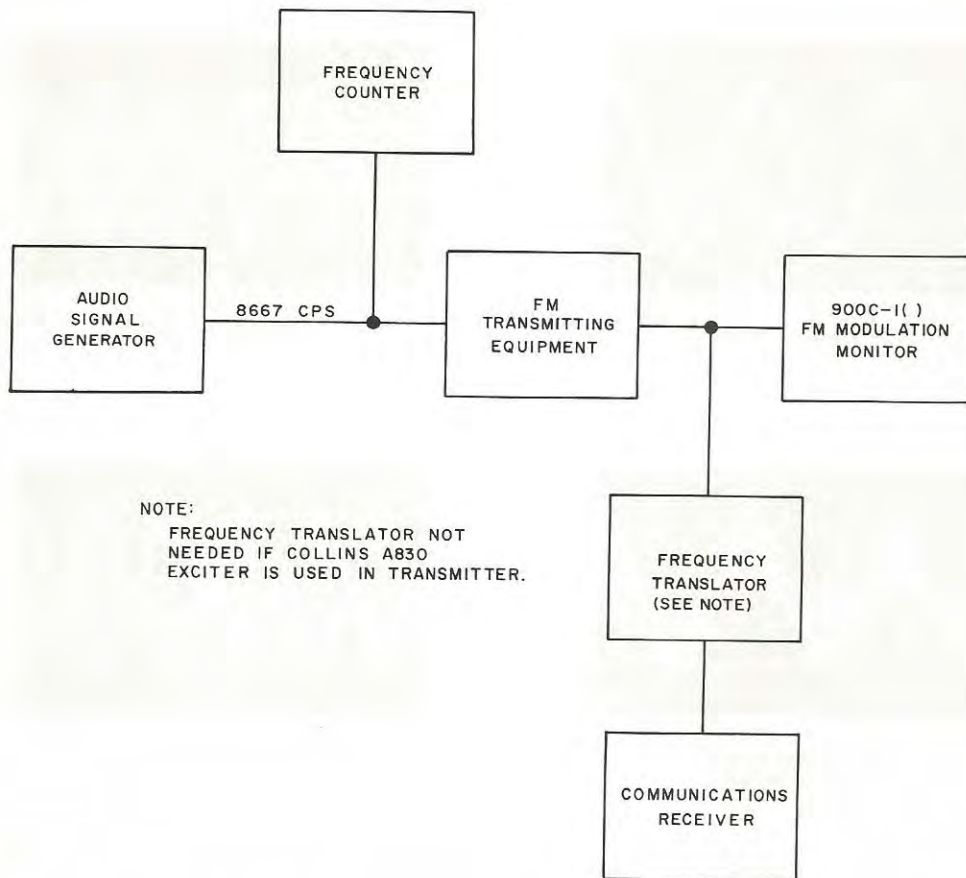

Figure 5-4. Test Setup for Modulation Meter Calibration Adjustment

b. If 100 percent is not indicated on the front panel meter, adjust R10 for an exact 100 percent indication.

c. Switch the POLARITY switch to the NEG position to determine that the positive and negative meter readings are equal.

d. Return the MODULATION METER CAL switch to the OFF position. Leave the POLARITY switch in the NEG position.

5.4.5 MAIN CHANNEL MODULATION ADJUSTMENT (900C-1, 900C-1A, 900C-1B, 900C-1C).

a. Set the METER switch to the TOTAL MOD position.

b. Apply a 400-cps modulating signal to the station console and adjust the transmitter for 100 percent modulation as indicated on the 900C-1().

c. Set the METER switch to the MAIN CHAN MOD position. If a front panel meter indication of 100 percent is not obtained, adjust R17 for a 100 percent modulation indication.

d. Return the METER switch to the TOTAL MOD position.

5.4.6 SUBCHANNEL MODULATION ADJUSTMENT (900C-1, 900C-1A ONLY).

a. Place the METER switch in the TOTAL MOD position.

b. Apply a 38-kc input signal for 100 percent modulation as indicated on the 900C-1() front panel meter.

c. Place the METER switch in the SUB CHAN MOD position.

d. If the front panel meter does not indicate exactly 100 percent, adjust R14 for an indication of 100 percent.

e. Return the METER switch to the TOTAL MOD position.

5.4.7 SCA MODULATION ADJUSTMENT (900C-1, 900C-1B ONLY).

a. Place the METER switch in the TOTAL MOD position.

b. Apply a 67-kc signal from the SCA equipment to the transmitter exciter.

c. Adjust the 67-kc input signal until 100 percent modulation is indicated on the modulation monitor front panel meter.

d. Note the exciter 67-kc input signal voltage for 100 percent modulation on a Hewlett-Packard 400L audio voltmeter.

e. Adjust the modulation to 30 percent by lowering the 67-kc signal voltage to 3/10 of the voltage noted in step d.

f. Place the METER switch in the SCA MOD position.

g. If the monitor front panel meter does not indicate 30 percent on the lower scale, adjust R16 for a meter reading of 30 percent.

h. Return the METER switch to the TOTAL MOD position.

5.4.8 PEAK LIGHT ADJUSTMENT (900C-1, 900C-1A, 900C-1B, 900C-1C).

a. Modulate the transmitter 100 percent as indicated on the monitor front panel meter with a 400-cps input signal.

b. Turn the PERCENT MODULATION control until the PEAKS light flashes intermittently. The PERCENT MODULATION control should indicate 100 exactly.

c. Modulate the transmitter 50 percent as indicated on the monitor front panel meter with the 400-cps signal.

d. Turn the PERCENT MODULATION control until the PEAKS light flashes intermittently. The PERCENT MODULATION control should indicate 50 exactly.

e. If the conditions of steps b and d are not met, proceed with the remaining steps of this procedure.

f. Remove the PERCENT MODULATION adjustment knob from its shaft.

g. Modulate the transmitter 100 percent, as indicated on the monitor front panel meter, with a 400-cps signal.

h. With the transmitter modulated 100 percent, rotate the PERCENT MODULATION control until the PEAKS light flashes intermittently. Replace the PERCENT MODULATION knob so that knob points to 100 percent with the PEAKS light flashing intermittently.

i. Reduce the transmitter modulation to 50 percent as indicated on the monitor.

j. Rotate the PERCENT MODULATION control until the PEAKS light flashes intermittently. The control should indicate 50 percent modulation.

k. If the PERCENT MODULATION control indicates more than 50, perform step l. If the PERCENT MODULATION control indicates less than 50, perform step m.

l. Adjust R18 slightly in the clockwise direction and repeat steps f through k.

m. Adjust R18 slightly in the counterclockwise direction and repeat steps f through k.

NOTE

Potentiometer R18 determines the threshold spread and also affects the center of this spread. Each time R18 is adjusted, the PERCENT MODULATION knob must be readjusted on its shaft. The final adjustment will result in tracking between the front panel meter and the PERCENT MODULATION control at 50 and 100 percent modulation levels.

n. Tighten the PERCENT MODULATION knob securely.

5.4.9 19-KC TUNING ADJUSTMENTS (900C-1, 900C-1A ONLY).

a. Remove the 19-kc amplifier card from the monitor and place it on the card extender connected in its place.

b. Place a short jumper across capacitor C555.
c. Connect a Tektronix 545A high impedance probe to the collector pin of transistor Q550.

d. Apply 19 kc ± 5 cps modulation to the transmitter and adjust the transmitter for 10 percent modulation as indicated on the monitor front panel meter. Monitor the 19-kc output with an HP-524D frequency counter. The METER switch should be in the TOTAL MOD position.

e. Adjust L551 for maximum 19-kc voltage as indicated on the oscilloscope.

f. Remove the jumper from across C555 and adjust L553 for a minimum oscilloscope indication.

g. Remove the card extender and replace the 19-kc amplifier card in its socket.

5.4.10 PILOT MODULATION ADJUSTMENT (900C-1, 900C-1A ONLY).

a. Connect an audio signal generator, an HP-400L audio voltmeter, and an HP-524D frequency counter to the transmitter exciter audio input.

b. Place the 900C-1() METER switch in the TOTAL MOD position.

c. Apply 19-kc ± 5 -cps signal to the transmitter. Modulate the transmitter 100 percent as indicated on the monitor front panel meter.

d. Note the transmitter audio input voltage as indicated on the HP-400L audio voltmeter.

e. Adjust the transmitter audio input voltage to 3/10 that noted in step d. This modulates the transmitter 30 percent.

f. Place the METER switch in the PILOT MOD position.

g. The front panel meter should indicate 30 percent modulation as read on the lower scale.

h. If the requirement of step g is not met, adjust R15 for a reading of 30 percent as indicated on the monitor front panel meter lower scale.

i. Return the METER switch to the TOTAL MOD position. Remove the test equipment from the transmitter audio input.

5.4.11 38-KC TANK CIRCUIT TUNING (900C-1, 900C-1A ONLY).

a. Apply a pilot carrier from the station's stereo generator. Do not apply audio to the stereo generator.

b. Place the SUB CARRIER PHASE CAL switch to the NOR position and note the monitor front panel meter reading. Adjust this reading with the METER ADJUST control to 100.

c. Switch the SUB CARRIER PHASE CAL switch to the REV position and note the meter reading.

d. The meter readings in steps b and c should be equal. If these readings are not equal, adjust L450 on the stereo demodulator card until the readings in the NOR and REV positions are the same. This reading should be adjustable by the METER ADJUST control for a reading of 100.

e. Return the SUB CARRIER PHASE CAL switch to the OFF position.

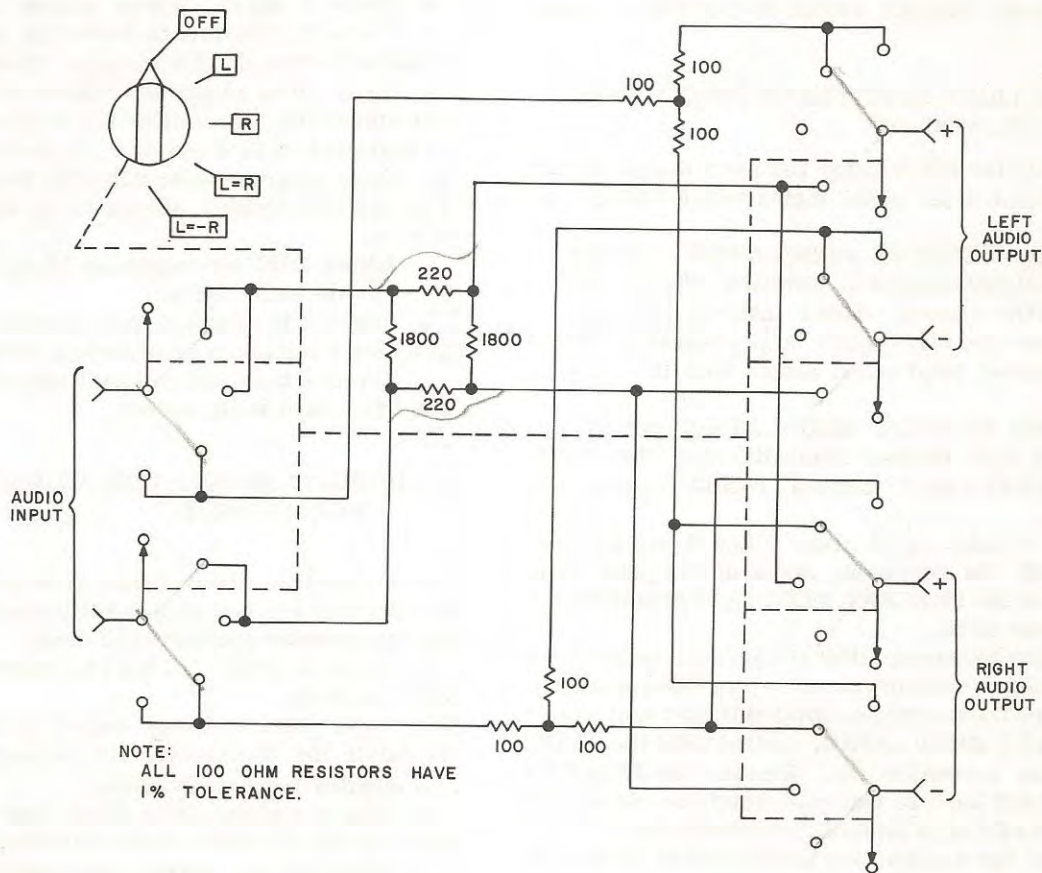

Figure 5-5. Test Switch for Obtaining Stereo Signals

5.4.12 STEREO DEMODULATOR ADJUSTMENTS
(900C-1, 900C-1A ONLY).

CAUTION

The following calibration adjustments must only be performed if a Collins 786M-1 Stereo Generator and a Collins A830-1 10 W Wide-Band FM Broadcast Exciter is available for use as the transmitter stereo input equipment.

- a. Construct a stereo test switch as illustrated in figure 5-5.
- b. Connect the stereo test switch and audio generator to the 900C-1() and the station transmitting equipment as indicated in figure 5-6.
- c. Place the station's transmitting equipment in the stereo mode.
- d. Set the stereo test switch in the L=-R position. Place the modulation monitor METER switch in the TOTAL MOD position.
- e. Adjust the transmitter to modulate 100 percent as indicated on the modulation monitor with a 400-cps input signal.
- f. Repeat paragraph 5.4.11 to calibrate the monitor 38-kc phasing.

g. Check the pilot carrier phase adjustment of the station's stereo generator. Adjust if necessary. This adjustment technique is given in the 786M-1 Stereo Generator instruction book. The adjustment must be set for optimum performance in order to complete the remaining monitor demodulator adjustments.

h. Place the stereo demodulator card on the card extender and remove transistor Q451 from its socket. Place a jumper between TP450 and TP451.

i. Place the station's stereo generator in the monaural mode and modulate the transmitter 100 percent with a 400-cycle input signal.

j. Place the 900C-1() METER switch in the LEFT AUDIO position and note the meter reading.

k. Place the 900C-1() METER switch in the RIGHT AUDIO position and again note the meter reading.

l. If the readings of steps j and k are not equal, equalize these readings by adjusting the right channel gain adjustment, R34.

m. Again check the adjustment by repeating steps j through l.

n. Replace transistor Q451 in its socket and remove the jumper between TP450 and TP451. Remove the card extender and the stereo demodulator card and replace the stereo demodulator card in its socket.

o. Place the stereo generator in the stereo mode. Place the test switch to the L=R position.

p. Modulate the transmitter 100 percent as indicated on the modulation monitor with a 400-cps signal.

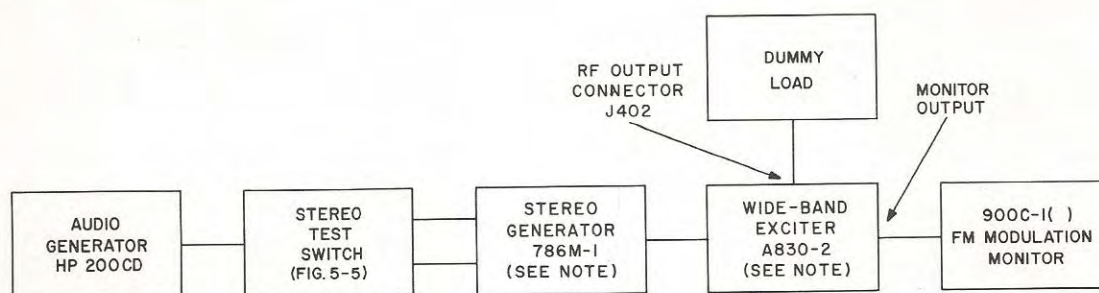

NOTE:
REPLACE PRE-EMPHASIS NETWORKS WITH
18DB FLAT ATTENUATOR NETWORK.

Figure 5-6. Test Setup for Stereo Demodulator Adjustments

- q. Place the 900C-1() METER switch in the LEFT AUDIO position and note the meter reading.
- r. Place the 900C-1() METER switch in the RIGHT AUDIO position and again note the meter reading.
- s. If the readings of steps q and r are not equal, equalize these readings by adjusting the stereo demodulator balance adjustment, R29.
- t. Place the 900C-1() METER switch in the LEFT AUDIO position.
- u. Place the test switch in the L=R position and note the modulation monitor meter reading.
- v. Place the test switch in the L=-R position and again note the meter reading.
- w. If the readings of steps u and v are not equal, equalize the readings by adjusting the stereodemodulator channel separation adjustment, R31.
- x. Recheck the preceding adjustments by switching the METER switch to the LEFT AUDIO and RIGHT

AUDIO positions while the modulation is alternately switched from L=R to L=-R. All four meter readings should be the same. If these readings are not the same, repeat steps o through w.

- y. Place the METER switch to the RIGHT AUDIO position.
- z. Set the test switch in the left only position and modulate the transmitter 100 percent with a 400-cps signal.
- aa. Adjust R31 for maximum channel separation by setting R31 for a minimum meter reading.

NOTE

When adjusting R31, the meter sensitivity must be increased. Move the DECIBELS switch clockwise as the channel separation is increased.



Faint, illegible text in the left column, possibly a list or a series of short paragraphs.

Faint, illegible text in the right column, possibly a list or a series of short paragraphs.

section 6

parts list

ITEM	DESCRIPTION	COLLINS PART NUMBER
900C-1() FM MODULATION MONITOR		522-3275-00
C1	CAPACITOR, FIXED, MICA: 1000 uuf ±50%, 500 v dc; Electro Motive part no. DM19F102V500WV	912-3001-00
C2	CAPACITOR, VARIABLE, AIR: plate meshing type; 100.5 uuf max, 6 uuf min capacity; aluminum or brass plates	922-0024-00
C3	CAPACITOR, FIXED, MICA: 100 uuf ±5%, 500 v dc; Electro Motive part no. DM15F101J500WV	912-2816-00
C4	CAPACITOR, FIXED, MICA: 7500 uuf ±5%, 500 v dc; Electro Motive part no. DM30F752J	912-2726-00
C5	CAPACITOR, FIXED, PAPER: 0.1 uf ±20%, 400 v dc; Sprague Electric Co. part no. 160P10404	931-5491-00
C6	CAPACITOR, FIXED, ELECTROLYTIC: 1000 uf -10% +100%, 50 v dc; Sprague Electric Co. part no. D33643	183-1403-00
C7	CAPACITOR, FIXED, ELECTROLYTIC: same as C6	183-1403-00
C8	CAPACITOR, FIXED, ELECTROLYTIC: same as C6	183-1403-00
C9	CAPACITOR, FIXED, ELECTROLYTIC: 500 uf -10% +100%, 50 v dc; Sprague Electric part no. D34998	183-1575-00
C10	CAPACITOR, FIXED, CERAMIC: 0.05 uf -20% +50%, 500 v dc; Sprague Electric Co. of Wisconsin part no. 33C58	913-3153-00
C11	CAPACITOR, FIXED, ELECTROLYTIC: 2 uf -10% +100% 50 v dc; Sprague Electric part no. 30D190A1	183-1183-00
C12	CAPACITOR, FIXED, CERAMIC: 10,000 uuf ±20%, 500 v dc	913-3013-00
C13	CAPACITOR, FIXED, PAPER: same as C5	931-5491-00
C14	CAPACITOR, FIXED, ELECTROLYTIC: 500 uf, -10% +100% 50 v dc; Sprague Electric part no. D34998	183-1575-00
CR1	SEMICONDUCTOR DEVICE, DIODE: type 1N830A	353-1526-00
CR2	SEMICONDUCTOR DEVICE, DIODE: silicon; General Electric Co. part no. 1N538	
CR3	SEMICONDUCTOR DEVICE, DIODE: same as CR2	353-1526-00
CR4	SEMICONDUCTOR DEVICE SET: two hermetically sealed silicon voltage reference diodes; Motorola part no. 10M10ZB1	353-1238-00
CR5	SEMICONDUCTOR DEVICE, DIODE: silicon; Raytheon Mfg. Co. part no. 1N1124A	353-1301-00
DS1	LAMP, GLOW: neon, 1/4 w, 110-125 v ac, single contact bayonet candelabra, T-3-1/4 bulb; 1-3/16 in. h; 5000 hrs rated life; w/o internal resistor; General Electric part no. NE-51H	262-0680-00
DS2	LAMP, INDICATOR: T-3-1/4 bulb; 36 v dc; 0.10 amps; General Electric Co. part no. 1822	262-0353-00
DS3	LAMP, INCANDESCENT: miniature, single contact w/T-3-1/4, clear bulb; 28 v; 0.17 amp; MIL type MS15571-4	262-3270-00
DS4	LAMP, INCANDESCENT: same as DS3	262-3270-00
F1	FUSE, CARTRIDGE: glass case, brass ferrules; 1/8 amp, 250 volt; Bussman part no. MDL-1/8	264-0290-00
F2	FUSE, CARTRIDGE: 1/2 amp, 250 v; glass case, brass ferrules; Bussman part no. MDL-1/2	264-0293-00
FL1	FILTER, LOWPASS: 5000 ohms input, 5000 ohms output impedance; 30 cps to 15,000 cps pass band, 19,100 cps to 75,000 cps stop band; 1-3/4 in. by 2-3/4 in. by 2-13/16 in., excl terminals	673-1014-00
FL2	FILTER, BANDPASS: 5000 ohms input, 5000 ohms output impedance; 23,000 cps to 53,000 cps frequency response; 30 cps to 15,000 cps and 59,000 cps to 75,000 cps stop band; 1-3/4 in. by 2-3/4 in. by 3-13/16 in., excl terminals	673-1015-00

ITEM	DESCRIPTION	COLLINS PART NUMBER
FL3	FILTER, HIGHPASS: 5000 ohms input, 5000 ohms output impedance; 59,000 cps and above, 67,000 cps frequency response; 30 cps to 53,000 cps stop band; 1-11/16 in. by 2-1/16 in. by 3-1/8 in. excl terminals	673-1016-00
FL4	FILTER, LOWPASS: 600 ohms input, 600 ohms output impedance; 50 cps to 53,000 cps, 50 cps to 75,000 cps, 400 kc to 1200 kc frequency response; 1-11/16 in. by 2-1/16 in. by 3-1/8 in.; excl terminals	673-1013-00
FL5	FILTER, LOWPASS: same as FL1	673-1014-00
J1	CONNECTOR, RECEPTACLE, ELECTRICAL: 22 contacts, 5 amps; Amphenol Borg Electronic Corp. part no. 143-022-01-1106	372-7257-00
J2	CONNECTOR, RECEPTACLE, ELECTRICAL: same as J1	372-7257-00
J3	CONNECTOR, RECEPTACLE, ELECTRICAL: same as J1	372-7257-00
J4	CONNECTOR, RECEPTACLE, ELECTRICAL: same as J1	372-7257-00
J5	CONNECTOR, RECEPTACLE, ELECTRICAL: same as J1	372-7257-00
J6	CONNECTOR, RECEPTACLE, ELECTRICAL: same as J1	372-7257-00
J7	CONNECTOR, RECEPTACLE, ELECTRICAL: same as J1	372-7257-00
J8	CONNECTOR, RECEPTACLE, ELECTRICAL: same as J1	372-7257-00
J9	CONNECTOR, RECEPTACLE, ELECTRICAL: same as J1	372-7257-00
J10	CONNECTOR, RECEPTACLE, ELECTRICAL: same as J1	372-7257-00
J11	CONNECTOR, RECEPTACLE, ELECTRICAL: same as J1	372-7257-00
J12	JACK, TELEPHONE: steel, panel mtd, 5/8 in. od by 27/32 in. lg; Switchcraft part no. 3505F	360-0195-00
J13	CONNECTOR, RECEPTACLE, ELECTRICAL: 3 female contacts; 15 amp, 125 v dc; panel mtg; Pass & Seymour Inc. part no. DS-2001	368-0115-00
J14	JACK, TELEPHONE: same as J12	360-0195-00
J15	JACK, TELEPHONE: same as J12	360-0195-00
J16	CONNECTOR, RECEPTACLE, ELECTRICAL: 3 male contacts; 125 volts; 7 amps; Tower Mfg. Corp. part no. H-1061	368-0207-00
J17	JACK, TELEPHONE: same as J12	360-0195-00
J18	JACK, TELEPHONE: same as J12	360-0195-00
J19	JACK, TELEPHONE: same as J12	360-0195-00
J20	JACK, TELEPHONE: same as J12	360-0195-00
J21	JACK, TELEPHONE: same as J12	360-0195-00
J22	JACK, TELEPHONE: same as J12	360-0195-00
J23	JACK, TELEPHONE: same as J12	360-0195-00
J24	JACK, TELEPHONE: same as J12	360-0195-00
K1	RELAY, ARMATURE: 4 C; low level or up to 2 amps at 28 v, resistive; 24 v dc nom coil voltage, 650 ohms ±10% at +25 deg C coil resistance; continuous duty cycle; Potter & Brumfield part no. KHP 17D13	970-2257-00
L1	COIL, RADIO FREQUENCY: single layer wound, #20-22 AWG wire; 3.90 uh inductance, 2.40 ohms dc resistance, 280 ma dc current; MIL type MS16225-14	240-1575-00
M1	AMMETER, DIRECT CURRENT: 0 to 500 ua, 610 ohms meter resistance; 3.125 in. by 4.060 in. by 5.031 in	458-0725-00
R1	RESISTOR, FIXED, COMPOSITION: 68 ohms ±10%, 2 w; MIL type RC42GF680K	745-5603-00
R2	RESISTOR, FIXED, COMPOSITION: 180 ohms ±10%, 2 w; MIL type RC42GF181K	745-5621-00
R3	RESISTOR, FIXED, COMPOSITION: 10,000 ohms ±10%, 1 4 w; MIL type RC07GF103K	745-0785-00

SECTION 6
Parts List

ITEM	DESCRIPTION	COLLINS PART NUMBER
R4	RESISTOR, FIXED, FILM: 3160 ohms $\pm 1\%$, 1/4 w; MIL type RN65B3161F	705-7120-00
R5	RESISTOR, FIXED, COMPOSITION: 8,200 ohms $\pm 10\%$, 1/4 w; MIL type RC07GF822K	745-0782-00
R6	RESISTOR, FIXED, COMPOSITION: 10,000 ohms $\pm 10\%$, 1/2 w; MIL type RC20GF103K	745-1394-00
R7	RESISTOR, FIXED, COMPOSITION: 3,900 ohms $\pm 10\%$, 1/4 w; MIL type RC07GF392K	745-0770-00
R8	RESISTOR, VARIABLE, COMPOSITION: 5,000 ohms $\pm 20\%$, 0.2 w; Chicago Telephone Supply Co. part no. 376-0205-00	376-0205-00
R9	RESISTOR, FIXED, FILM: 619 ohms $\pm 1\%$, 1/4 w; MIL type RN65B6190F	705-7086-00
R10	RESISTOR, VARIABLE, COMPOSITION: 250 ohms $\pm 20\%$, 0.2 w; Chicago Telephone Supply Co. part no. 376-0201-00	376-0201-00
R11	RESISTOR, VARIABLE COMPOSITION: 250 ohms $\pm 20\%$, 0.2 w	376-4604-00
R12	RESISTOR, FIXED, FILM: 3,830 ohms $\pm 1\%$, 1/4 w; MIL type RN65B3851F	705-7124-00
R13	RESISTOR, FIXED, FILM: 1,000 ohms $\pm 1\%$, 1/4 w; MIL type RN65B1001F	705-7096-00
R14	RESISTOR, VARIABLE, COMPOSITION: same as R8	376-0205-00
R15	RESISTOR, VARIABLE, COMPOSITION: same as R8	376-0205-00
R16	RESISTOR, VARIABLE, COMPOSITION: same as R8	376-0205-00
R17	RESISTOR, VARIABLE, COMPOSITION: same as R8	376-0205-00
R18	RESISTOR, VARIABLE, COMPOSITION: same as R8	376-0205-00
R19	RESISTOR, FIXED, COMPOSITION: same as R5	745-0782-00
R20	RESISTOR, FIXED, FILM: 4,640 ohms $\pm 1\%$, 1/4 w; MIL type RN65B4641F	705-7128-00
R21	RESISTOR, FIXED, FILM: 681 ohms $\pm 1\%$, 1/4 w; MIL type RN65B6810F	705-7088-00
R22	RESISTOR, FIXED, COMPOSITION: same as R7	745-0770-00
R23	RESISTOR, FIXED, COMPOSITION: 1,000 ohms $\pm 10\%$, 1/4 w; MIL type RC07GF102K	745-0749-00
R24	RESISTOR, FIXED, WIREWOUND: 5.0 ohms $\pm 10\%$, 5 w; IRC part no. PW5-5R00-10	710-9105-00
R25	RESISTOR, FIXED, WIREWOUND: 18 ohms $\pm 5\%$, 6.5 w; Dale Products part no. HS-5	747-5425-00
R26	RESISTOR, FIXED, WIREWOUND: same as R25	745-5425-00
R27	RESISTOR, FIXED, WIREWOUND: same as R25	745-5425-00
R28	RESISTOR, FIXED, WIREWOUND: 1,200 ohms $\pm 10\%$, 1/4 w; MIL type RC07GF122K	745-0752-00
R29	RESISTOR, VARIABLE, COMPOSITION: 1,000 ohms $\pm 20\%$, 0.2 w; Chicago Telephone Supply Co. part no. 376-0203-00	376-0203-00
R30	RESISTOR, FIXED, COMPOSITION: same as R28	745-0752-00
R31	RESISTOR, VARIABLE, COMPOSITION: same as R8	376-0205-00
R32	RESISTOR, FIXED, FILM: same as R13	705-7096-00
R33	RESISTOR, FIXED, FILM: 12,100 ohms $\pm 1\%$, 1/4 w; MIL type RN65B1212F	705-7148-00
R34	RESISTOR, VARIABLE, COMPOSITION: same as R8	376-0205-00
R35	RESISTOR, FIXED, FILM: 8,250 ohms $\pm 1\%$, 1/4 w; MIL type RN65B8251F	705-7140-00
R36	RESISTOR, FIXED, FILM: 42,200 ohms $\pm 1\%$, 1/8 w; MIL type RN60B4222F	705-6674-00
R37	RESISTOR, FIXED, FILM: 3160 ohms $\pm 1\%$, 1/8 w; MIL type RN60B3161F	705-6620-00
R38	RESISTOR, FIXED, FILM: 28,700 ohms $\pm 1\%$, 1/8 w; MIL type RN60B2872F	705-6666-00
R39	RESISTOR, FIXED, FILM: 1,330 ohms $\pm 1\%$, 1/8 w; MIL type RN60B1331F	705-6602-00
R40	RESISTOR, FIXED, FILM: 4640 ohms $\pm 1\%$, 1/8 w; MIL type RN60B4641F	705-6628-00
R41	RESISTOR, FIXED, FILM: 383 ohms $\pm 1\%$, 1/8 w; MIL type RN60B3830F	705-6576-00
R42	RESISTOR, FIXED, FILM: 1,780 ohms $\pm 1\%$, 1/8 w; MIL type RN60B1781F	705-6608-00
R43	RESISTOR, FIXED, FILM: 110 ohms $\pm 1\%$, 1/8 w; MIL type RN60B1100F	705-6550-00
R44	RESISTOR, FIXED, FILM: 316 ohms $\pm 1\%$, 1/8 w; MIL type RN60B3160F	705-6572-00
R45	RESISTOR, FIXED, WIREWOUND: 1500 ohms $\pm 3\%$, 25 w	747-8676-00
R46	RESISTOR, FIXED, FILM: 90.9 ohms $\pm 1\%$, 1/8 w; MIL type RN60B909F	705-6546-00

ITEM	DESCRIPTION	COLLINS PART NUMBER
R47	RESISTOR, VARIABLE, COMPOSITION: 250 ohms $\pm 20\%$, 1/4 w	376-2483-00
R48	RESISTOR, FIXED, COMPOSITION: 180 ohms $\pm 10\%$, 1/4 w; MIL type RC07GF181K	745-0722-00
R49	RESISTOR, FIXED, FILM: 34.8 ohms $\pm 1\%$, 1/8 w; MIL type RN60B3488F	705-6526-00
R50	RESISTOR, FIXED, FILM: 1,960 ohms $\pm 1\%$, 1/4 w; MIL type RN65B1961F	705-7110-00
R51	RESISTOR, VARIABLE, WIREWOUND: 500 ohms $\pm 10\%$, 2 w; MIL type RA20NASD501A	750-0510-00
R52	RESISTOR, FIXED, FILM: 51.1 ohms $\pm 1\%$, 1/4 w; MIL type RN65B51R1F	705-7034-00
R53	RESISTOR, FIXED, COMPOSITION: 47,000 ohms $\pm 10\%$, 1/4 w; MIL type RC07GF473K	745-0809-00
R54	RESISTOR, FIXED, COMPOSITION: 0.10 megohm $\pm 10\%$, 1/4 w; MIL type RC07GF104K	745-0821-00
R55	RESISTOR, FIXED, FILM: 619 ohms $\pm 1\%$, 1/8 w; MIL type RN60B6190F	705-6586-00
R56	RESISTOR, FIXED, FILM: 12,100 ohms $\pm 1\%$, 1/8 w; MIL type RN60B1212F	705-6648-00
R57	RESISTOR, FIXED, FILM: same as R21	705-7088-00
R58	RESISTOR, FIXED, COMPOSITION: 330 ohms $\pm 10\%$, 1 w; MIL type RC32GF331K	745-3331-00
R59	RESISTOR, FIXED, FILM: same as R20	705-7128-00
R60	RESISTOR, FIXED, FILM: 17.8 ohms $\pm 10\%$, 1/8 w; MIL type RN60B1788F	705-6512-00
S1	SWITCH, ROTARY: 10 circuit, 10 pole, 10 position, 5 section; 10 moving contacts, 71 fixed contacts	259-1954-00
S2	SWITCH, ROTARY: 6 circuit, 6 pole, 2 position, 2 section; 6 moving contacts, 18 fixed contacts	259-1955-00
S3	SWITCH, ROTARY: 3 circuit, 3 pole, 2 position, 1 section; 3 moving contacts, 7 fixed contacts	259-1956-00
S4	SWITCH, ROTARY: 1 circuit, 1 pole, 2 position, 1 section; 1 moving contact, 3 fixed contacts	259-1957-00
S5	SWITCH, ROTARY: 5 circuit, 5 pole, 3 position, 2 section; 5 moving contacts, 13 fixed contacts	259-1958-00
S6	SWITCH, TOGGLE: DPST: 125 v ac, 15 amps, 250 v ac, 10 amps; Cutler-Hammer, Inc. part no. 7561K4	266-0099-00
S7	SWITCH, ROTARY: 1 circuit, 1 pole, 6 position, 1 section; 1 moving contact, 8 fixed contacts	259-1959-00
T1	TRANSFORMER, POWER, STEP-DOWN: primary 120 ohms, 240 ohms; secondary 78 ohms, CT, 28 ohms; 50/60 cps; continuous duty cycle; Stancor Electronics part no. 32740	044-1310-662
T2	TRANSFORMER, AUDIO FREQUENCY: primary 50 ohms, secondary 10,000 ohms; 50 to 45,000 cps frequency response; continuous duty cycle	044-1288-667
TB1	TERMINAL BOARD: phenolic; 12 terminals: 0.250 in. by 0.6875 in. by 5.187 in.; Howard B. Jones, Division of Cinch Mfg. Corp. part no. 353-18-12-001	367-0020-00
XDS1	LIGHT, INDICATOR: for use with T-3-1/4 miniature bayonet base bulb, polished chrome; Dialight part no. 81410-1-PC	262-0093-00
XDS2	LIGHT, INDICATOR: smooth frosted slip-fit lens, used w/type miniature bayonet base G-4 1/2 or T-3 1/4 lamps indicator, solder lug terminals; incl. hardware	262-1271-00
XDS3	LAMPHOLDER: for use with T-3-1/4 miniature bayonet base lamp; MIL type MS90282-3	262-0913-00
XDS4	LAMPHOLDER: same as XDS3	262-0913-00
XF1	FUSEHOLDER: for use with (1-1/4 x 1/4) fuses, 15 amps, 250 volts; Bussman Fuse Co. part no. HKP-HJR	265-1019-00
XF2	FUSEHOLDER: same as XF1	265-1019-00
XY1	SOCKET, ELECTRON TUBE: octal contact; molded construction; low loss composition; 5/8 in. h., 1-7/64 in. dia., 1-7/8 in. lg., excl. terminals and contacts; MIL type TS101P01	220-1121-00
Y1	OVEN, CRYSTAL: for two HC-6U crystal holders, 75 deg C oven temp, 115 v ac 10 w heater rating; James Knight Co. part no. 900-0069	292-0184-00
OSCILLATOR - TRIPLER - MIXER A1		528-0430-00
C100	CAPACITOR, FIXED, MICA: 470 uuf $\pm 5\%$, 500 v dc; Electro Motive Mfg. Co. part no. DM19F471J500WV	912-2974-00

ITEM	DESCRIPTION	COLLINS PART NUMBER
C101	CAPACITOR, FIXED, CERAMIC: 0.1 uf -20% +80%, 50 v dc; Sprague Electric Co. part no. 33C41	913-3886-00
C102	CAPACITOR, FIXED, CERAMIC: same as C101	913-3886-00
C103	CAPACITOR, FIXED, CERAMIC: same as C101	913-3886-00
C104	CAPACITOR, FIXED, PAPER: 0.01 uf ±20%, 200 v dc; Sprague Electric part no. 160P10302	931-5500-00
C105	CAPACITOR, FIXED, MICA: 47 uuf ±5%, 500 v dc; Electro Motive part no. DM15E470J500WV	912-2792-00
C106	CAPACITOR, FIXED, MICA: 1000 uuf ±5%, 500 v dc; Electro Motive part no. DM19F102J500WV	912-3001-00
C107	CAPACITOR, FIXED, MICA: 18 uuf ±10%, 500 v dc; Electro Motive Mfg. Co. part no. DM15C180K500WV	912-2763-00
C108	CAPACITOR, FIXED, CERAMIC: 1000 uuf -20% +100%, 500 v dc; Erie Resistor Corp. part no. 851000 X5U0 102Z	913-3009-00
C109	CAPACITOR, FIXED, CERAMIC: same as C108	913-3009-00
C110	CAPACITOR, FIXED, CERAMIC: same as C108	913-3009-00
C111	CAPACITOR, FIXED, CERAMIC: same as C101	913-3886-00
C112	CAPACITOR, FIXED, CERAMIC: same as C101	913-3886-00
C113	CAPACITOR, FIXED, MICA: 120 uuf ±5%, 500 v dc; Electro Motive Mfg. Co. part no. DM15F121J500WV	912-2822-00
C114	CAPACITOR, FIXED, CERAMIC: same as C101	913-3886-00
C115	CAPACITOR, FIXED, CERAMIC: same as C101	913-3886-00
C116	CAPACITOR, FIXED, MICA: 91 uuf ±5%, 500 v dc; Electro Motive Mfg. Co. part no. CM05F910J03	912-2813-00
C117	CAPACITOR, FIXED, PAPER: same as C104	931-5500-00
C118	CAPACITOR, VARIABLE: 1.8 uuf -12.40 uuf	922-1007-00
C119	CAPACITOR: same as C118	922-1007-00
CR100	SEMICONDUCTOR DEVICE, DIODE: silicon; hermetically sealed; Motorola Inc. part no. 1N716A	353-2731-00
L100	COIL, RADIO FREQUENCY: 1.00 uh ±10% inductance, 0.30 ohms dc resistance, 900 ma dc current rating, MIL type LT7K108	240-1568-00
L101	COIL, RADIO FREQUENCY: 10 uh ±10% inductance, .60 ohms dc resistance, 700 ma dc current rating; MIL type LT7K140	240-1600-00
L102	INDUCTOR: toroid	
L103	INDUCTOR: coil	
L104	COIL, RADIO FREQUENCY: 2000 uh nom inductance, 27.5 ohms dc resistance, 0.1 amp current rating, Delevan Electronics Corp. part no. 2500-42	240-2547-00
Q100	TRANSISTOR: type 2N2380	044-5840-04
Q101	TRANSISTOR: germanium; hermetically sealed; Philco part no. 2N2362	352-0407-00
Q102	TRANSISTOR: same as Q101	352-0407-00
Q103	TRANSISTOR: germanium, JETEC type 2N1225	352-0135-00
R100	RESISTOR, FIXED, COMPOSITION: 100 ohms ±10%, 1 w; MIL type RC32GF101K	745-3310-00
R101	RESISTOR, FIXED, COMPOSITION: 33 ohms ±10%, 1/4 w; MIL type RC07GF330K	745-0695-00
R102	RESISTOR, FIXED, COMPOSITION: 56 ohms ±10%, 1/4 w; MIL type RC07GF560K	745-0704-00
R103	RESISTOR, FIXED, COMPOSITION: 470 ohms ±10%, 1/4 w; MIL type RC07GF471K	745-0737-00
R104	RESISTOR, FIXED, COMPOSITION: 1,000 ohms ±10%, 1/4 w; MIL type RC07GF102K	745-0749-00
R105	RESISTOR, FIXED, COMPOSITION: 2,200 ohms ±10%, 1/4 w; MIL type RC07GF222K	745-0761-00
R106	RESISTOR, FIXED, COMPOSITION: 8,200 ohms ±10%, 1/4 w; MIL type RC07GF822K	745-0782-00
R107	RESISTOR, FIXED, COMPOSITION: 100 ohms ±10%, 1/4 w; MIL type RC07GF101K	745-0713-00
R108	RESISTOR, FIXED, COMPOSITION: 18,000 ohms ±10%, 1/4 w; MIL type RC07GF183K	745-0794-00
R109	RESISTOR, FIXED, COMPOSITION: 6,800 ohms ±10%, 1/4 w; MIL type RC07GF682K	745-0779-00
R110	RESISTOR, FIXED, COMPOSITION: same as R105	745-0761-00
R111	RESISTOR, FIXED, COMPOSITION: same as R107	745-0713-00
R112	RESISTOR, FIXED, COMPOSITION: 68 ohms ±10%, 1/4 w; MIL type RC07GF680K	745-0707-00
R113	RESISTOR, FIXED, COMPOSITION: same as R103	745-0737-00

ITEM	DESCRIPTION	COLLINS PART NUMBER
R114	RESISTOR, FIXED, COMPOSITION: 680 ohms ±10%, 1 w; MIL type RC32GF681K	745-3345-00
R115	RESISTOR, FIXED, COMPOSITION: 39,000 ohms ±10%, 1/4 w; MIL type RC07GF393K	745-0806-00
R116	RESISTOR, FIXED, COMPOSITION: 15,000 ohms ±10%, 1/4 w; MIL type RC07GF153K	745-0791-00
R117	RESISTOR, FIXED, COMPOSITION: 3,300 ohms ±10%, 1/4 w; MIL type RC07GF332K	745-0767-00
R118	RESISTOR, FIXED, COMPOSITION: same as R107	745-0713-00
R119	RESISTOR, FIXED, COMPOSITION: same as R104	745-0749-00
T100	TRANSFORMER:	
TP100	JACK, TIP: for use with standard 0.080 tip plug, double ended; black body; Amp. Inc. part no. 2-582120-0	360-0277-00
TP101	JACK TIP: for use with standard 0.080 tip plug, double ended; grey body; Amp. Inc. part no. 2-582120-8	360-0275-00
TP102	JACK, TIP: for use with standard 0.080 tip plug, double ended; white body; Amp. Inc. part no. 2-582120-9	360-0276-00
XQ100	SOCKET, TRANSISTOR: 3 contacts spaced on an 0.200 in. dia circle; Elco Corp. part no. 3307X	352-9903-00
XQ101	SOCKET, TRANSISTOR: 4 contacts spaced on an 0.200 in. dia circle; Elco Corp. part no. 3307	352-9902-00
XQ102	SOCKET, TRANSISTOR: same as XQ101	352-9902-00
XQ103	SOCKET, TRANSISTOR: same as XQ101	352-9902-00
XY100	SOCKET, CRYSTAL: for u w crystal size HC-6/U and HC-13/U for horizontal or vertical panel mtg; phosphor bronze contacts, teflon insulation; Augat Bros, Inc. part no. 8000 AG2	292-0215-00
Y100	CRYSTAL UNIT, QUARTZ: 500.000 kc; MIL type CR-46/U500.000KC	
PULSE COUNTING DEMODULATOR A2		528-0431-00
C150	CAPACITOR, FIXED, CERAMIC: 0.1 uf -20% +80%, 50 v dc; Sprague Electric Co. part no. 33C41	913-3886-00
C151	CAPACITOR, FIXED, PAPER: 0.01 uf ±20%, 200 v dc; Sprague Electric Co. part no. 160P10302	931-5500-00
C152	CAPACITOR, FIXED, MICA: 200 uuf ±5%, 500 v dc; Electro Motive part no. DM15F201J500WV	912-2837-00
C153	CAPACITOR, FIXED, MICA: 180 uuf ±5%, 500 v dc; Electro Motive part no. DM15F181J500WV	912-2834-00
C154	CAPACITOR, FIXED, MICA: 130 uuf ±5%, 500 v dc; Electro Motive part no. DM15F131J500WV	912-2825-00
C155	CAPACITOR, FIXED, ELECTROLYTIC: 250 uf -10% +100%, 30 v dc; Sprague Electric part no. 4Y12B	183-1901-00
C156	CAPACITOR, FIXED, ELECTROLYTIC: same as C155	183-1901-00
C157	CAPACITOR, FIXED, PAPER: same as C151	931-5500-00
C158	CAPACITOR, FIXED, CERAMIC: 1000 uuf -20% +100%, 500 v dc; Erie Resistor Corp. part no. 851000 X5U0 102Z	913-3009-00
CR150	SEMICONDUCTOR DEVICE, DIODE: germanium; hermetically sealed; JETEC type 1N270	353-2018-00
CR151	SEMICONDUCTOR DEVICE, DIODE: same as CR150	353-2018-00
CR152	SEMICONDUCTOR DEVICE, DIODE: silicon; hermetically sealed; JETEC type 1N3022A	353-1317-00
Q150	TRANSISTOR: silicon; hermetically sealed; JETEC type 2N706	352-0195-00
Q151	TRANSISTOR: same as Q150	352-0195-00
Q152	TRANSISTOR: same as Q150	352-0195-00
Q153	TRANSISTOR: same as Q150	352-0195-00
Q154	TRANSISTOR: type 2N2380	
R150	RESISTOR, FIXED, COMPOSITION: 5600 ohms ±10%, 1/4 w; MIL type RC07GF562K	745-0776-00
R151	RESISTOR, FIXED, COMPOSITION: 100 ohms ±10%, 1/4 w; MIL type RC07GF101K	745-0713-00
R152	RESISTOR, FIXED, COMPOSITION: same as R150	745-0776-00
R153	RESISTOR, FIXED, COMPOSITION: 1,500 ohms ±10%, 1/4 w; MIL type RC07GF152K	745-0755-00
R154	RESISTOR, FIXED, FILM: 3,830 ohms ±1%, 1/4 w; MIL type RN65B3831F	705-7124-00
R155	RESISTOR, FIXED, FILM: 681 ohms ±1%, 1/4 w; MIL type RN65B6810F	705-7088-00
R156	RESISTOR, FIXED, FILM: 383 ohms ±1%, 1/4 w; MIL type RN65B3830F	705-7076-00

SECTION 6

Parts List

ITEM	DESCRIPTION	COLLINS PART NUMBER
R157	RESISTOR, FIXED, FILM: same as R154	705-7124-00
R158	RESISTOR, FIXED, FILM: 38.3 ohms $\pm 1\%$, 1/4 w; MIL type RN65B38R3F	705-7028-00
R159	RESISTOR, FIXED, FILM: 2,150 ohms $\pm 1\%$, 1/4 w; MIL type RN65B2151F	705-7112-00
R160	RESISTOR, FIXED, FILM: 383 ohms $\pm 1\%$, 1/2 w; MIL type RN70B3830F	705-7576-00
R161	RESISTOR, FIXED, FILM: 1,000 ohms $\pm 1\%$, 1/4 w; MIL type RN65B1001F	705-7096-00
R162	RESISTOR, FIXED, FILM: same as R159	705-7112-00
R163	RESISTOR, FIXED, FILM: 1000 ohms $\pm 1\%$, 1/2 w; MIL type RN70B1001F	705-7596-00
R164	RESISTOR, FIXED, FILM: 12,100 ohms $\pm 1\%$, 1/4 w; MIL type RN65B1212F	705-7148-00
R165	RESISTOR, FIXED, FILM: 10,000 ohms $\pm 1\%$, 1/4 w; MIL type RN65B1002F	705-7144-00
R166	RESISTOR, FIXED, FILM: same as R161	705-7096-00
R167	RESISTOR, FIXED, FILM: 619 ohms $\pm 1\%$, 1/4 w; MIL type RN65B6190F	705-7086-00
R168	RESISTOR, FIXED, FILM: 825 ohms $\pm 1\%$, 1/4 w; MIL type RN65B8250F	705-7092-00
R169	RESISTOR, FIXED, COMPOSITION: same as R151	745-0713-00
R170	RESISTOR, FIXED, COMPOSITION: 100 ohms $\pm 10\%$, 1 w; MIL type RC32GF101K	745-3310-00
TP150	JACK, TIP: for use with standard 0.080 tip plug, double ended; white body; Amp. Inc. part no. 2-582120-9	360-0276-00
TP151	JACK, TIP: for use with standard 0.080 tip plug, double ended; black body; Amp. Inc. part no. 2-582120-0	360-0277-00
XQ150	SOCKET, TRANSISTOR: 3 contacts spaced on an 0.200 in. dia circle; Elco Corp. part no. 3307X	352-9903-00
XQ151	SOCKET, TRANSISTOR: same as XQ150	352-9903-00
XQ152	SOCKET, TRANSISTOR: same as XQ150	352-9903-00
XQ153	SOCKET, TRANSISTOR: same as XQ150	352-9903-00
XQ154	SOCKET, TRANSISTOR: same as XQ150	352-9903-00
PHASE SPLITTER A3		528-0432-00
C200	CAPACITOR, FIXED, ELECTROLYTIC: 20 uf -10% to +100%, 25 v dc; Sprague Electric Co. part no. 40D181A2	183-1365-00
C201	CAPACITOR, FIXED, ELECTROLYTIC: same as C200	183-1365-00
C202	CAPACITOR, FIXED, ELECTROLYTIC: 250 uf -10% to +100%, 30 v dc; Sprague Electric Co. part no. 4Y12B	183-1901-00
C203	CAPACITOR, FIXED, ELECTROLYTIC: same as C200	183-1365-00
C204	CAPACITOR, FIXED, ELECTROLYTIC: 50 uf -10% +100%, 50 v dc; Sprague Electric Co. part no. D33003	183-1398-00
C205	CAPACITOR, FIXED, ELECTROLYTIC: same as C200	183-1365-00
C206	CAPACITOR, FIXED, ELECTROLYTIC: same as C202	183-1901-00
C207	CAPACITOR, FIXED, CERAMIC: 0.01 uf -20% +80%, 100 v dc; Erie Resistor Corp. part no. 855502 X5G0 103P	913-3680-00
C208	CAPACITOR, FIXED, ELECTROLYTIC: same as C200	183-1365-00
C209	CAPACITOR, FIXED, ELECTROLYTIC: 100 uf -10 +100%, 25 v dc; Sprague Electric part no. 30D34489	183-1192-00
C210	CAPACITOR, FIXED, ELECTROLYTIC: same as C204	183-1398-00
C211	CAPACITOR, FIXED, ELECTROLYTIC: same as C204	183-1398-00
L200	COIL, RADIO FREQUENCY: 2000 uh nom inductance, 27.5 ohms dc resistance, 0.1 amp current rating; Delevan Electronics Corp. part no. 2500-42	240-2547-00
L201	COIL, RADIO, FREQUENCY: single layer wound #20 -22 AWG wire; 2.20 uh inductance, 1.00 ohms dc resistance, 500 ma dc current; MS type MS16225-11	240-1572-00
Q200	TRANSISTOR: germanium; JETEC type 2N1225	352-0135-00
Q201	TRANSISTOR: silicon; hermetically sealed; JETEC type 2N697	352-0197-00
Q202	TRANSISTOR: same as Q201	352-0197-00
Q203	TRANSISTOR: hermetically sealed; PNP germanium; JETEC type 2N1175A	352-0315-00

ITEM	DESCRIPTION	COLLINS PART NUMBER
R200	RESISTOR, FIXED, COMPOSITION: 82,000 ohms $\pm 10\%$, 1/4 w; MIL type RC07GF823K	745-0818-00
R201	RESISTOR, FIXED, FILM: 23,700 ohms $\pm 1\%$, 1/4 w; MIL type RN65B2372F	705-7162-00
R202	RESISTOR, FIXED, COMPOSITION: 5,600 ohms $\pm 10\%$, 1/4 w; MIL type RC07GF562K	745-0776-00
R203	RESISTOR, FIXED, COMPOSITION: 820 ohms $\pm 10\%$, 1/4 w; MIL type RC07GF821K	745-0746-00
R204	RESISTOR, FIXED, COMPOSITION: 680 ohms $\pm 10\%$, 1/4 w; MIL type RC07GF681K	745-0743-00
R205	RESISTOR, FIXED, COMPOSITION: 12,000 ohms $\pm 10\%$, 1/4 w; MIL type RC07GF123K	745-0788-00
R206	RESISTOR, FIXED, COMPOSITION: 27,000 ohms $\pm 10\%$, 1/4 w; MIL type RC07GF273K	745-0800-00
R207	RESISTOR, FIXED, COMPOSITION: 390 ohms $\pm 10\%$, 1/4 w; MIL type RC07GF391K	745-0734-00
R208	RESISTOR, FIXED, COMPOSITION: 270 ohms $\pm 10\%$, 1/4 w; MIL type RC07GF271K	745-0728-00
R209	RESISTOR, FIXED, COMPOSITION: 0.10 meg- ohms $\pm 10\%$, 1/4 w; MIL type RC07GF104K	745-0821-00
R210	RESISTOR, FIXED, COMPOSITION: same as R202	745-0776-00
R211	RESISTOR, FIXED, COMPOSITION: 47,000 ohms $\pm 10\%$, 1/4 w; MIL type RC07GF473K	745-0809-00
R212	RESISTOR, FIXED, COMPOSITION: same as R203	745-0746-00
R213	RESISTOR, FIXED, FILM: 5,110 ohms $\pm 1\%$, 1/4 w; MIL type RN65B5111F	705-7130-00
R214	RESISTOR, FIXED, COMPOSITION: 3,900 ohms $\pm 10\%$, 1/4 w; MIL type RC07GF392K	745-0770-00
R215	RESISTOR, FIXED, COMPOSITION: 8,200 ohms $\pm 10\%$, 1/4 w; MIL type RC07GF822K	745-0782-00
R216	RESISTOR, FIXED, COMPOSITION: same as R202	745-0776-00
R217	RESISTOR, FIXED, COMPOSITION: 4700 ohms $\pm 10\%$, 1/4 w; MIL type RC07GF472K	745-0773-00
R218	RESISTOR, FIXED, COMPOSITION: 1,200 ohms $\pm 10\%$, 1/4 w; MIL type RC07GF122K	745-0752-00
R219	RESISTOR, FIXED, COMPOSITION: 10,000 ohms $\pm 10\%$, 1/4 w; MIL type RC07GF103K	745-0785-00
R220	RESISTOR, FIXED, COMPOSITION: same as R209	745-0821-00
R221	RESISTOR, FIXED, COMPOSITION: same as R209	745-0821-00
R222	RESISTOR: SELECTED IN PRODUCTION	
TP200	JACK, TIP: for use with standard 0.080 tip plug, double ended; white body; Amp. Inc. part no. 2-582120-9	360-0276-00
TP201	JACK, TIP: for use with standard 0.080 tip plug, double ended; black body; Amp. Inc. part no. 2-582120-0	360-0277-00
XQ200	SOCKET, TRANSISTOR: 4 contacts spaced on an 0.200 in. dia circle, Elco Corp. part no. 3307	352-9902-00
XQ201	SOCKET, TRANSISTOR: 3 contacts spaced on an 0.200 in. dia circle; Elco Corp. part no. 3307X	352-9903-00
XQ202	SOCKET, TRANSISTOR: same as XQ201	352-9903-00
XQ203	SOCKET, TRANSISTOR: same as XQ201	352-9903-00
PEAK VOLTMETER A4		528-0433-00
C250	CAPACITOR, FIXED, ELECTROLYTIC: 20 uf -10% +100%, 25 v dc; Sprague Electric Co. part no. 40D181A2	183-1365-00
C251	CAPACITOR, FIXED, ELECTROLYTIC: 250 uf -10% +100%, 30 v dc; Sprague Electric Co. part no. 4Y12B	183-1901-00
C252	CAPACITOR, FIXED, ELECTROLYTIC: same as C250	183-1365-00
C253	CAPACITOR, FIXED, ELECTROLYTIC: 8 uf -10% +100%, 50 v dc; Sprague Electric Co. part no. 40D192A2	183-1354-00
C254	CAPACITOR, FIXED, PAPER: 0.1 uf $\pm 20\%$, 100 v dc; Sprague Electric Co. part no. 196P10401S4	931-4488-00
C255	CAPACITOR, FIXED, ELECTROLYTIC: same as C250	183-1365-00
C256	CAPACITOR, FIXED, ELECTROLYTIC: same as C253	183-1354-00
C257	CAPACITOR, FIXED, ELECTROLYTIC: same as C250	183-1365-00
C258	CAPACITOR, FIXED, ELECTROLYTIC: same as C251	183-1901-00
C259	CAPACITOR, FIXED, ELECTROLYTIC: same as C250	183-1365-00

SECTION 6
Parts List

ITEM	DESCRIPTION	COLLINS PART NUMBER
C260	CAPACITOR, FIXED, ELECTROLYTIC: 50 uf -10% +100%, 25 v dc; Sprague Electric Co. part no. 40D184A2	183-1379-00
C261	CAPACITOR, FIXED, ELECTROLYTIC: same as C250	183-1365-00
C262	CAPACITOR, FIXED, ELECTROLYTIC: same as C251	183-1901-00
CR250	SEMICONDUCTOR DEVICE, DIODE: germanium; hermetically sealed; Transitron part no. 1N270	353-2018-00
CR251	SEMICONDUCTOR DEVICE, DIODE: same as CR250	353-2018-00
CR252	SEMICONDUCTOR DEVICE, DIODE: same as CR250	353-2018-00
L250	COIL, RADIO FREQUENCY: single layer wound; 642 turns no. 40 AWG wire; 2000 uh nom inductance, 27.5 ohms dc resistance; 0.1 amp current rating; Delevan Electronics Corp. part no. 2500-42	240-2547-00
Q250	TRANSISTOR: germanium; Joint Electronic Tube Engineering Council part no. 2N1225	352-0135-00
Q251	TRANSISTOR: same as Q250	352-0135-00
Q252	TRANSISTOR: Germanium; 2N1285	352-0243-00
Q253	TRANSISTOR: same as Q250	352-0135-00
Q254	TRANSISTOR: same as Q250	352-0135-00
Q255	TRANSISTOR: same as Q250	352-0135-00
R250	RESISTOR, FIXED, COMPOSITION: 47,000 ohms ±10%, 1/4 w; MIL type RC07GF473K	745-0809-00
R251	RESISTOR, FIXED, COMPOSITION: 8,200 ohms ±10%, 1/4 w; MIL type RC07GF822K	745-0782-00
R252	RESISTOR, FIXED, COMPOSITION: 5,600 ohms ±10%, 1/4 w; MIL type RC07GF562K	745-0776-00
R253	RESISTOR, FIXED, COMPOSITION: 120 ohms ±10%, 1/4 w; MIL type RC07GF121K	745-0716-00
R254	RESISTOR, FIXED, COMPOSITION: 1,200 ohms ±10%, 1/4 w; MIL type RC07GF122K	745-0752-00
R255	RESISTOR, FIXED, FILM: same as R251	745-0782-00
R256	RESISTOR, FIXED, COMPOSITION: same as R254	745-0752-00
R257	RESISTOR, FIXED, FILM: 23,700 ohms ±1%, 1/8 w; MIL type RN60B2372F	705-6662-00
R258	RESISTOR, FIXED, COMPOSITION: same as R252	745-0776-00
R259	RESISTOR, FIXED, COMPOSITION: same as R254	745-0752-00
R260	RESISTOR, FIXED, COMPOSITION: same as R252	745-0776-00
R261	RESISTOR, FIXED, COMPOSITION: 390 ohms ±10%, 1/4 w; MIL type RC07GF391K	745-0734-00
R262	RESISTOR, FIXED, COMPOSITION: same as R252	745-0776-00
R263	RESISTOR, FIXED, FILM: 1620 ohms ±1%, 1/4 w; MIL type RN65B1621F	705-7106-00
R264	RESISTOR, FIXED, COMPOSITION: 3,300 ohms ±10%, 1/4 w; MIL type RC07GF332K	745-0767-00
R265	RESISTOR, FIXED, FILM: 12,100 ohms ±1%, 1/8 w; MIL type RN60B1212F	705-6648-00
R266	RESISTOR, FIXED, FILM: 6,190 ohms ±1.0%, 1/8 w; MIL type RN60B6191F	705-6634-00
R267	RESISTOR, FIXED, COMPOSITION: 3,900 ohms ±10%, 1/4 w; MIL type RC07GF392K	745-0770-00
R268	RESISTOR, FIXED, COMPOSITION: 12,000 ohms ±10%, 1/4 w; MIL type RC07GF123K	745-0788-00
R269	RESISTOR, FIXED, COMPOSITION: 2,200 ohms ±10%, 1/4 w; MIL type RC07GF222K	745-0761-00
R270	RESISTOR, FIXED, COMPOSITION: same as R252	745-0776-00
R271	RESISTOR, FIXED, COMPOSITION: 10,000 ohms ±10%, 1/4 w; MIL type RC07GF103K	745-0785-00
R272	RESISTOR, FIXED, COMPOSITION: 27,000 ohms ±10%, 1/4 w; MIL type RC07GF273K	745-0800-00
R273	RESISTOR, FIXED, COMPOSITION: same as R269	745-0761-00
R274	RESISTOR, FIXED, COMPOSITION: same as R269	745-0761-00
R275	RESISTOR, FIXED, COMPOSITION: 22,000 ohms ±10%, 1/4 w; MIL type RC07GF223K	745-0797-00
R276	RESISTOR, SELECTED IN PRODUCTION	
R277	RESISTOR, FIXED, FILM: 1000 ohms ±1%, 1/4 w; MIL type RN65B1001F	705-7096-00
R278	RESISTOR, FIXED, COMPOSITION: 39,000 ohms ±10%, 1/4 w; MIL type RC07GF393K	745-0806-00
R279	RESISTOR, FIXED, COMPOSITION: 18,000 ohms ±10%, 1/4 w; MIL type RC07GF183K	745-0794-00

ITEM	DESCRIPTION	COLLINS PART NUMBER
RT250	RESISTOR, THERMAL: 1,000 ohms at 25 deg C ±10%, 1 w; Carborundum Co. type 763H-6	714-1732-00
RT251	RESISTOR, THERMAL: same as RT250	714-1732-00
TP250	JACK, TIP: for use with standard 0.080 tip plug, double ended; black body; Amp, Inc. part no. 2-582120-0	360-0277-00
TP251	JACK, TIP: for use with standard 0.080 tip plug, double ended; grey body; Amp, Inc. part no. 2-582120-8	360-0275-00
TP252	JACK, TIP: for use with standard 0.080 tip plug, double ended; white body; Amp, Inc. part no. 2-582120-9	360-0276-00
XQ250	SOCKET TRANSISTOR: 4 contacts spaced on an 0.200 in. dia circle; Elco Corp. part no. 3307	352-9902-00
XQ251	SOCKET TRANSISTOR: same as XQ250	352-9902-00
XQ252	SOCKET TRANSISTOR: same as XQ250	352-9902-00
XQ253	SOCKET TRANSISTOR: same as XQ250	352-9902-00
XQ254	SOCKET TRANSISTOR: same as XQ250	352-9902-00
XQ255	SOCKET TRANSISTOR: same as XQ250	352-9902-00
PEAK LIGHT A5		528-0434-00
C300	CAPACITOR, FIXED, ELECTROLYTIC: 2 uf -10% +100%, 50 v dc; Sprague Electric 40D187A2	183-1383-00
C301	CAPACITOR, FIXED, ELECTROLYTIC: 20 uf -10% +100%, 25 v dc; Sprague Electric Co. part no. 40D181A2	183-1365-00
C302	CAPACITOR, FIXED, MICA: 200 uuf ±5%, 500 v dc; Electro Motive part no. DM15F201J500WV	912-2837-00
C303	CAPACITOR, FIXED, ELECTROLYTIC: 100 uf -10% +100%, 25 v dc; Sprague Electric Co. part no. 30D188A1	183-1192-00
C304	CAPACITOR, FIXED, ELECTROLYTIC: same as C303	183-1192-00
C305	CAPACITOR, FIXED, MICA: same as C302	912-2837-00
C306	CAPACITOR, FIXED, PAPER: 0.68 uf ±20%, 200 v dc; Sprague Electric Co. part no. 118P6840254	951-1041-00
C307	CAPACITOR, FIXED, MICA: 100 uuf ±5%, 500 v dc; Electro Motive part no. DM15F101J500WV	912-2816-00
C308	CAPACITOR, FIXED, CERAMIC: 0.1 uf -20% +80%, 500 v dc; Sprague Electric Co. part no. 41C92	913-3152-00
C309	CAPACITOR, FIXED, MICA: 560 uuf ±5%, 500 v dc; MIL type CM06F561J03	912-2983-00
C310	CAPACITOR, FIXED, MICA: 33,000 uuf ±1%, 500 v dc; Electro Motive Mfg. Co. part no. DM42F333F03	912-3134-00
C311	CAPACITOR, FIXED, ELECTROLYTIC: 20 uf -10% +100%, 50 v dc; Sprague Electric Co. part no. 40D195A2	183-1369-00
C312	CAPACITOR, FIXED, MICA: 560 uuf ±5%, 500 v dc; Electro Motive Co. part no. DM19F561J500WV	912-2983-00
C313	CAPACITOR, FIXED, CERAMIC: 0.47 uf -20% +80%, 25 v dc; Sprague Electric part no. 5C11A	913-3804-00
C314	CAPACITOR, FIXED, MICA: same as C309	912-2983-00
C315	CAPACITOR, FIXED, MICA: same as C310	912-3134-00
C316	CAPACITOR, FIXED, ELECTROLYTIC: 1 uf -10% +100%, 50 v dc; Sprague Electric Co. part no. 40D186A2	183-1367-00
L300	REACTOR: 11/16 in. by 1-1/8 in. by 1-3/8 in.	756-3899-003
L301	REACTOR: same as L300	756-3899-003
Q300	TRANSISTOR: silicon; hermetically sealed; Fairchild part no. 2N697	352-0197-00
Q301	TRANSISTOR: germanium; hermetically sealed; Sylvania Electric part no. 2N1605	352-0348-00
Q302	TRANSISTOR: same as Q301	352-0348-00
Q303	TRANSISTOR: same as Q301	352-0348-00
Q304	TRANSISTOR: same as Q301	352-0348-00
Q305	TRANSISTOR: same as Q300	352-0197-00
Q306	TRANSISTOR: germanium; hermetically sealed; Sylvania Electric part no. 2N526	352-0123-00
Q307	TRANSISTOR: same as Q306	352-0123-00
R300	RESISTOR, FIXED, COMPOSITION: 33,000 ohms ±10%, 1/4 w; MIL type RC07GF333K	745-0803-00
R301	RESISTOR, FIXED, COMPOSITION: 8,200 ohms ±10%, 1/4 w; MIL type RC07GF822K	745-0782-00
R302	RESISTOR, FIXED, COMPOSITION: 560 ohms ±10%, 1/4 w; MIL type RC07GF561K	745-0740-00

SECTION 6

Parts List

ITEM	DESCRIPTION	COLLINS PART NUMBER
R303	RESISTOR, FIXED, COMPOSITION: 100 ohms ±10%, 1/4 w; MIL type RC07GF101K	745-0713-00
R304	RESISTOR, FIXED, COMPOSITION: 470 ohms ±10%, 1/4 w; MIL type RC07GF471K	745-0737-00
R305	RESISTOR, FIXED, COMPOSITION: 10,000 ohms ±10%, 1/4 w; MIL type RC07GF102K	745-0749-00
R306	RESISTOR, FIXED, COMPOSITION: 2,700 ohms ±10%, 1/4 w; MIL type RC07GF272K	745-0764-00
R307	RESISTOR, FIXED, COMPOSITION: 15,000 ohms ±10%, 1/4 w; MIL type RC07GF153K	745-0791-00
R308	RESISTOR, FIXED, COMPOSITION: same as R302	745-0740-00
R309	RESISTOR: SELECTED IN PRODUCTION	
R310	RESISTOR, FIXED, COMPOSITION: same as R305	745-0749-00
R311	RESISTOR, FIXED, COMPOSITION: 120 ohms ±10%, 1/4 w; MIL type RC07GF121K	745-0716-00
R312	RESISTOR, FIXED, COMPOSITION: 1000 ohms ±10%, 1/2 w; MIL type RC20GF102K	745-1352-00
R313	RESISTOR, FIXED, COMPOSITION: 10,000 ohms ±10%, 1/4 w; MIL type RC07GF103K	745-0785-00
R314	RESISTOR, FIXED, COMPOSITION: 39,000 ohms ±10%, 1/4 w; MIL type RC07GF393K	745-0806-00
R315	RESISTOR, FIXED, COMPOSITION: same as R312	745-1352-00
R316	RESISTOR, FIXED, COMPOSITION: 2,200 ohms ±10%, 1/4 w; MIL type RC07GF222K	745-0761-00
R317	RESISTOR, FIXED, COMPOSITION: 0.10 megohms ±10%, 1/4 w; MIL type RC07GF104K	745-0821-00
R318	RESISTOR, FIXED, COMPOSITION: same as R317	745-0821-00
R319	RESISTOR, FIXED, COMPOSITION: 390 ohms ±10%, 1/4 w; MIL type RC07GF391K	745-0734-00
R320	RESISTOR, FIXED, COMPOSITION: 4700 ohms ±10%, 1/4 w; MIL type RC07GF472K	745-0773-00
R321	RESISTOR, FIXED, COMPOSITION: same as R317	745-0821-00
R322	RESISTOR, FIXED, COMPOSITION: same as R317	745-0821-00
R323	RESISTOR, FIXED, COMPOSITION: same as R313	745-0785-00
R324	RESISTOR, FIXED, COMPOSITION: same as R313	745-0785-00
TP300	JACK, TIP: for use with standard 0.080 tip plug, double ended; white body; Amp, Inc. part no. 2-582120-9	360-0276-00
TP301	JACK, TIP: for use with standard 0.080 tip plug, double ended; black body; Amp, Inc. part no. 2-582120-0	360-0277-00
TP302	JACK, TIP: for use with standard 0.080 tip plug, double ended; grey body; Amp, Inc. part no. 2-582120-8	360-0275-00
XQ300	SOCKET, TRANSISTOR: 3 contacts spaced on an 0.200 in. dia circle; Elco Corp. part no. 3307X	352-9903-00
XQ301	SOCKET, TRANSISTOR: same as XQ300	352-9903-00
XQ302	SOCKET, TRANSISTOR: same as XQ300	352-9903-00
XQ303	SOCKET, TRANSISTOR: same as XQ300	352-9903-00
XQ304	SOCKET, TRANSISTOR: same as XQ300	352-9903-00
XQ305	SOCKET, TRANSISTOR: same as XQ300	352-9903-00
XQ306	SOCKET, TRANSISTOR: 4 contacts spaced on an 0.200 in dia circle; Elco Corp. part no. 3307	352-9902-00
XQ307	SOCKET, TRANSISTOR: same as XQ306	352-9902-00
AVERAGE VOLTMETER A6		528-0435-00
C350	CAPACITOR, FIXED, ELECTROLYTIC: 50 uf -10%, +100%, 50 v dc; Sprague Electric Co. part no. P33003	183-1398-00
C351	CAPACITOR, FIXED, ELECTROLYTIC: 20 uf -10% +100%, 25 v dc; Sprague Electric Co. part no. 40D181A2	183-1365-00
C352	CAPACITOR, FIXED, ELECTROLYTIC: 100 uf -10% +100%, 25 v dc; Sprague Electric part no. D34489	183-1192-00
C353	CAPACITOR, FIXED, ELECTROLYTIC: same as C351	183-1365-00
C354	CAPACITOR, FIXED, ELECTROLYTIC: same as C351	183-1365-00
C355	CAPACITOR, FIXED, ELECTROLYTIC: 250 uf -10% +100%, 30 v dc; Sprague Electric part no. 4Y12B	183-1901-00
C356	CAPACITOR, FIXED, ELECTROLYTIC: same as C352	183-1192-00

ITEM	DESCRIPTION	COLLINS PART NUMBER
C357	CAPACITOR, FIXED, ELECTROLYTIC: same as C352	183-1192-00
C358	CAPACITOR, FIXED, ELECTROLYTIC: same as C350	183-1398-00
C359	CAPACITOR, FIXED, ELECTROLYTIC: same as C355	183-1901-00
C360	CAPACITOR, FIXED, ELECTROLYTIC: same as C350	183-1398-00
C361	CAPACITOR, FIXED, ELECTROLYTIC: same as C355	183-1901-00
C362	CAPACITOR, FIXED, ELECTROLYTIC: same as C350	183-1398-00
CR350	SEMICONDUCTOR DEVICE, DIODE: germanium: hermetically sealed: Transitron part no. 1N270	353-2018-00
CR351	SEMICONDUCTOR DEVICE, DIODE: same as CR350	353-2018-00
CR352	SEMICONDUCTOR DEVICE, DIODE: same as CR350	353-2018-00
CR353	SEMICONDUCTOR DEVICE, DIODE: same as CR350	353-2018-00
Q350	TRANSISTOR: germanium: hermetically sealed: General Electric part no. 2N1175A	352-0315-00
Q351	TRANSISTOR: germanium: JETEC type 2N1225	352-0135-00
Q352	TRANSISTOR: same as Q351	352-0135-00
Q353	TRANSISTOR: same as Q351	352-0135-00
Q354	TRANSISTOR: same as Q351	352-0135-00
R350	RESISTOR, FIXED, COMPOSITION: 3,900 ohms, ±10%, 1/4 w; MIL type RC07GF392K	745-0770-00
R351	RESISTOR, FIXED, COMPOSITION: 680 ohms ±10%, 1/4 w; MIL type RC07GF681K	745-0743-00
R352	RESISTOR, FIXED, COMPOSITION: 56,000 ohms ±10%, 1/4 w; MIL type RC07GF563K	745-0812-00
R353	RESISTOR, FIXED, COMPOSITION: MIL type RC20GF681K	745-1345-00
R354	RESISTOR, FIXED, COMPOSITION: 0.10 megohm ±10%, 1/4 w; MIL type RC07GF104K	745-0821-00
R355	RESISTOR, FIXED, COMPOSITION: 22,000 ohms ±10%, 1/4 w; MIL type RC07GF223K	745-0797-00
R356	RESISTOR, FIXED, COMPOSITION: 5,600 ohms ±10%, 1/4 w; MIL type RC07GF562K	745-0776-00
R357	RESISTOR, FIXED, COMPOSITION: 180 ohms ±10%, 1/4 w; MIL type RC07GF181K	745-0722-00
R358	RESISTOR, FIXED, COMPOSITION: 1,800 ohms ±10%, 1/4 w; MIL type RC07GF182K	745-0758-00
R359	RESISTOR, FIXED, COMPOSITION: 27,000 ohms ±10%, 1/4 w; MIL type RC07GF273K	745-0800-00
R360	RESISTOR, FIXED, COMPOSITION: 39,000 ohms ±10%, 1/4 w; MIL type RC07GF393K	745-0806-00
R361	RESISTOR, FIXED, COMPOSITION: same as R356	745-0776-00
R362	RESISTOR, FIXED, COMPOSITION: 47,000 ohms ±10%, 1/4 w; MIL type RC07GF473K	745-0809-00
R363	RESISTOR, FIXED, COMPOSITION: 10,000 ohms ±10%, 1/4 w; MIL type RC07GF103K	745-0785-00
R364	RESISTOR, FIXED, COMPOSITION: 12,000 ohms ±10%, 1/4 w; MIL type RC07GF123K	745-0788-00
R365	RESISTOR, FIXED, COMPOSITION: 100 ohms ±10%, 1/4 w; MIL type RC07GF101K	745-0713-00
R366	RESISTOR, FIXED, COMPOSITION: 2,200 ohms ±10%, 1/4 w; MIL type RC07GF222K	745-0761-00
R367	RESISTOR, FIXED, COMPOSITION: 15,000 ohms ±10%, 1/4 w; MIL type RC07GF153K	745-0791-00
R368	RESISTOR, FIXED, COMPOSITION: 68,000 ohms ±10%, 1/4 w; MIL type RC07GF683K	745-0815-00
R369	RESISTOR, FIXED, COMPOSITION: same as R356	745-0776-00
R370	RESISTOR, FIXED, COMPOSITION: 3300 ohms ±10%, 1/4 w; MIL type RC07GF332K	745-0767-00
R371	RESISTOR, FIXED, COMPOSITION: same as R358	745-0758-00
R372	RESISTOR, FIXED, COMPOSITION: 47 ohms ±10%, 1/4 w; MIL type RC07GF470K	745-0701-00
R373	RESISTOR, FIXED, COMPOSITION: same as R363	745-0785-00
TP350	JACK, TIP: for use with standard 0.080 tip plug, double ended; white body; Amp, Inc. part no. 2-582120-9	360-0276-00
TP351	JACK, TIP: for use with standard 0.080 tip plug, double ended; black body; Amp, Inc. part no. 2-582120-0	360-0277-00
XQ350	SOCKET, TRANSISTOR: 3 contact spaced on an 0.200 in. dia circle, Elco Corp. part no. 3307X	352-9903-00
XQ351	SOCKET, TRANSISTOR: 4 contacts spaced on an 0.200 in. dia circle, Elco Corp. part no. 3307	352-9902-00
XQ352	SOCKET, TRANSISTOR: same as XQ351	352-9902-00
XQ353	SOCKET, TRANSISTOR: same as XQ351	352-9902-00
XQ354	SOCKET, TRANSISTOR: same as XQ351	352-9902-00

SECTION 6
Parts List

ITEM	DESCRIPTION	COLLINS PART NUMBER
19-KC AMPLIFIER A7		528-0436-00
C550	CAPACITOR, FIXED, ELECTROLYTIC: 100 uf -10% +100%, 25 v dc; Sprague Electric part no. D34489	183-1192-00
C551	CAPACITOR, FIXED, ELECTROLYTIC: 20 uf -10% +100%, 25 v dc; Sprague Electric Co. part no. 40D181A2	183-1365-00
C552	CAPACITOR, FIXED, ELECTROLYTIC: same as C550	183-1192-00
C553	CAPACITOR, FIXED, MICA: 30,000 uuf ±1%, 500 v dc; Electro Motive Mfg. Co. part no. DM42F303F03	912-3131-00
C554	CAPACITOR, FIXED, MICA: 560 uuf ±5%, 500 v dc; Electro Motive Co. part no. DM19E561J500WV	912-2983-00
C555	CAPACITOR, FIXED, MICA: same as A7C553	912-3131-00
C556	CAPACITOR, FIXED, CERAMIC: 0.47 uf -20% +80%, 25 v dc; Sprague Electric part no. 5C11A	913-3804-00
C557	CAPACITOR, FIXED, ELECTROLYTIC: same as C551	183-1365-00
C558	CAPACITOR, FIXED, ELECTROLYTIC: same as C550	183-1192-00
C559	CAPACITOR, FIXED, ELECTROLYTIC: 1 uf -10% +100%, 50 v dc; Sprague Electric Co. part no. 40D186A2	183-1367-00
C560	CAPACITOR, FIXED, ELECTROLYTIC: 2 uf -10% +100%, 50 v dc; Sprague Electric part no. 40D187A2	183-1383-00
L550	REACTOR: 11/16 in. by 1-1/8 in. by 1-3/8 in.	756-3899-003
L551	COIL, RADIO FREQUENCY: 200 to 280 uh inductance, 100 v dc, #20 AWG; 0.580 in. by 0.671 in. by 0.750 in.	278-1864-00
L552	REACTOR: same as L550	756-3899-003
L553	COIL, RADIO FREQUENCY: same as L551	278-1864-00
Q550	TRANSISTOR: germanium; hermetically sealed; Sylvania Electric part no. 2N526	352-0123-00
Q551	TRANSISTOR: same as Q550	352-0123-00
R550	RESISTOR, FIXED, COMPOSITION: 0.10 megohm ±10%, 1/4 w; MIL type RC07GF104K	745-0821-00
R551	RESISTOR, FIXED, COMPOSITION: same as R550	745-0821-00
R552	RESISTOR, FIXED, COMPOSITION: 1,000 ohms ±10%, 1/4 w; MIL type RC07GF102K	745-0749-00
R553	RESISTOR, FIXED, COMPOSITION: 4,700 ohms ±10%, 1/4 w; MIL type RC07GF472K	745-0773-00
R554	RESISTOR, FIXED, COMPOSITION: 220 ohms ±10%, 1/4 w; MIL type RC07GF221K	745-0725-00
R555	RESISTOR, FIXED, COMPOSITION: same as R550	745-0821-00
R556	RESISTOR, FIXED, COMPOSITION: same as R550	745-0821-00
R557	RESISTOR, FIXED, COMPOSITION: 10,000 ohms ±10%, 1/4 w; MIL type RC07GF103K	745-0785-00
R558	RESISTOR, FIXED, COMPOSITION: same as R554	745-0725-00
R559	RESISTOR, FIXED, COMPOSITION: 12,000 ohms ±10%, 1/4 w; MIL type RC07GF123K	745-0788-00
R560	RESISTOR, FIXED, COMPOSITION: same as R550	745-0821-00
R561	RESISTOR, FIXED COMPOSITION: same as R550	745-0821-00
TP550	JACK, TIP: for use with standard 0.080 tip plug, double ended; white body; Amp, Inc. part no. 2-582120-9	360-0276-00
TP551	JACK, TIP: for use with standard 0.080 tip plug, double ended; black body; Amp, Inc. part no. 2-582120-0	360-0277-00
XQ550	SOCKET, TRANSISTOR: 3 contact spaced on an 0.200 in. dia circle; Elco Corp. part no. 3307X	352-9903-00
XQ551	SOCKET, TRANSISTOR: same as XQ550	352-9903-00
AMPLIFIER-DOUBLER A8		528-0437-00
C500	CAPACITOR, FIXED, ELECTROLYTIC: 1 uf -10% +100%, 50 v dc; Sprague Electric Co. part no. 40D186A2	183-1367-00
C501	CAPACITOR, FIXED, CERAMIC: 0.1 uf -20% +80%, 50 v dc; Sprague Electric Co. part no. 33C41	913-3886-00
C502	CAPACITOR, FIXED, ELECTROLYTIC: 20 uf -10% to +100%, 25 v dc; Sprague Electric Co. part no. 40D18142	183-1365-00

ITEM	DESCRIPTION	COLLINS PART NUMBER
C503	CAPACITOR, FIXED, CERAMIC: 0.05 uf -20% +80%, 50 v dc; Sprague Electric Co. part no. 55C23A2	913-3885-00
C504	CAPACITOR, FIXED, CERAMIC: same as C503	913-3885-00
C505	CAPACITOR, FIXED, ELECTROLYTIC: same as C502	183-1365-00
C506	CAPACITOR, FIXED, CERAMIC: same as C501	913-3886-00
C507	CAPACITOR, FIXED, CERAMIC: 0.47 uf -20% +80%, 25 v dc; Sprague Electric Co. part no. 5C11A	913-3804-00
C508	CAPACITOR, FIXED, ELECTROLYTIC: same as C502	183-1365-00
C509	CAPACITOR, FIXED, MICA: 4300 uuf ±1%, 300 v dc; Cornell-Dubilier Electric Corp. part no. CD19F432F03	912-3047-00
C510	CAPACITOR, FIXED, MICA: 560 uuf ±5%, 500 v dc; Electro Motive Co. part no. DM19F561J500WV	912-2983-00
C511	CAPACITOR, FIXED, MICA: 390 uuf ±5%, 500 v dc; MIL type CM05F391J03	912-2858-00
CR500	SEMICONDUCTOR DEVICE, DIODE: germanium; hermetically sealed; Transitron part no. IN270	353-2018-00
CR501	SEMICONDUCTOR DEVICE, DIODE: same as CR500	353-2018-00
L500	REACTOR: 11/16 in. by 1-1/8 in. by 1-3/8 in.	756-3901-003
Q500	TRANSISTOR: germanium; hermetically sealed; Sylvania Electric Co. part no. 2N1285	352-0243-00
Q501	TRANSISTOR: same as Q500	352-0243-00
Q502	TRANSISTOR: same as Q500	352-0243-00
R500	RESISTOR, FIXED, COMPOSITION: 0.15 megohms ±10%, 1/4 w; MIL type RC07GF154K	745-0827-00
R501	RESISTOR, FIXED, COMPOSITION: 18,000 ohms ±10%, 1/4 w; MIL type RC07GF183K	745-0794-00
R502	RESISTOR, FIXED, COMPOSITION: 33,000 ohms ±10%, 1/4 w; MIL type RC07GF333K	745-0803-00
R503	RESISTOR, FIXED, COMPOSITION: 3,900 ohms ±10%, 1/4 w; MIL type RC07GF392K	745-0770-00
R504	RESISTOR, FIXED, COMPOSITION: 0.10 megohm ±10%, 1/4 w; MIL type RC07GF104K	745-0821-00
R505	RESISTOR, FIXED, COMPOSITION: 47,000 ohms ±10%, 1/4 w; MIL type RC07GF473K	745-0809-00
R506	RESISTOR, FIXED, COMPOSITION: 2,200 ohms ±10%, 1/4 w; MIL type RC07GF222K	745-0761-00
R507	RESISTOR, FIXED FILM: 1,470 ohms ±1%, 1/8 w; MIL type RN60B1471F	705-6604-00
R508	RESISTOR, FIXED, COMPOSITION: 220 ohms ±10%, 1/4 w; MIL type RC07GF221K	745-0725-00
R509	RESISTOR, FIXED, COMPOSITION: 22,000 ohms ±10%, 1/4 w; MIL type RC07GF223K	745-0797-00
R510	RESISTOR, FIXED, COMPOSITION: same as R509	745-0797-00
R511	RESISTOR, FIXED, COMPOSITION: 1,000 ohms ±10%, 1/4 w; MIL type RC07GF102K	745-0749-00
R512	RESISTOR, FIXED, COMPOSITION: same as R502	745-0803-00
R513	RESISTOR, FIXED, COMPOSITION: same as R504	745-0821-00
R514	RESISTOR, FIXED, COMPOSITION: same as R508	745-0725-00
R515	RESISTOR, FIXED, COMPOSITION: 1,500 ohms ±10%, 1/4 w; MIL type RC07GF152K	745-0755-00
R516	RESISTOR, FIXED, COMPOSITION: 39,000 ohms ±10%, 1/4 w; MIL type RC07GF393K	745-0806-00
TP500	JACK, TIP: for use with standard 0.080 tip plug, double ended; white body; Amp, Inc. part no. 2-582120-9	360-0276-00
TP501	JACK, TIP: for use with standard 0.080 tip plug, double ended; black body; Amp, Inc. part no. 2-582120-0	360-0277-00
XQ500	SOCKET TRANSISTOR: 4 contacts spaced on an 0.200 in. dia circle, Elco Corp., part no. 3307	352-9902-00
XQ501	SOCKET TRANSISTOR: same as XQ500	352-9902-00
XQ502	SOCKET TRANSISTOR: same as XQ500	352-9902-00
STEREO DEMODULATOR A9		528-0438-00
C450	CAPACITOR, FIXED, ELECTROLYTIC: 50 uf -10% +100%, 25 v dc; Sprague Electric Co. part no. 40D184A2	183-1379-00
C451	CAPACITOR, FIXED, ELECTROLYTIC: 100 uf -10% +100%, 25 v dc; Sprague Electric Co. part no. D34489	183-1192-00

SECTION 6
Parts List

ITEM	DESCRIPTION	COLLINS PART NUMBER
C452	CAPACITOR, FIXED, ELECTROLYTIC: 20 uf -10%, +100%, 25 v dc; Sprague Electric Co. part no. 40D18142	183-1365-00
C453	CAPACITOR, FIXED, ELECTROLYTIC: same as C450	183-1379-00
C454	CAPACITOR, FIXED, ELECTROLYTIC: same as C451	183-1192-00
C455	CAPACITOR, FIXED, ELECTROLYTIC: same as C452	183-1365-00
C456	CAPACITOR, FIXED, MICA: 12,000 uuf ±1%, 300 v dc; Electro Motive Mfg. Co. part no. DM30F123F03	912-3070-00
C457	CAPACITOR, FIXED, MICA: 120 uuf ±5%, 500 v dc; Electro Motive part no. DM15F121J500WV	912-2822-00
CR450	SEMICONDUCTOR DEVICE, MATCHED QUAD: four matched silicon diodes, encapsulated; Fairchild Semiconductors part no. FA-4000	353-3271-00
L450	COIL, RADIO FREQUENCY: 200 to 280 uh inductance, 100 v dc, #20 AWGS 0.580 in. by 0.671 in. by 0.750 in.	278-1864-00
L451	COIL, RADIO FREQUENCY: 3.90 uh ±10%, 1.50 ohms dc resistance; 550 ma dc rated current; MS type MS16222-8	240-1657-00
L452	COIL, RADIO FREQUENCY: same as L451	240-1657-00
Q450	TRANSISTOR: silicon, hermetically sealed; Hughes Aircraft part no. 2N706	352-0195-00
Q451	TRANSISTOR: same as A9Q450	352-0195-00
R450	RESISTOR, FIXED, FILM: 5,110 ohms ±1%, 1/4 w; MIL type RN65B5111F	705-7130-00
R451	RESISTOR, FIXED, FILM: same as R450	705-7130-00
R452	RESISTOR, FIXED, COMPOSITION: 220 ohms ±10%, 1/4 w; MIL type RC07GF221K	745-0725-00
R453	RESISTOR, FIXED, COMPOSITION: 47,000 ohms ±10%, 1/4 w; MIL type RC07GF473K	745-0809-00
R454	RESISTOR, FIXED, COMPOSITION: 2,200 ohms ±10%, 1/4 w; MIL type RC07GF222K	745-0761-00
R455	RESISTOR, FIXED, COMPOSITION: same as R454	745-0761-00
R456	RESISTOR, FIXED, COMPOSITION: same as R452	745-0725-00
R457	RESISTOR, FIXED, COMPOSITION: same as R453	745-0809-00
R458	RESISTOR, FIXED, COMPOSITION: same as R454	745-0761-00
R459	RESISTOR, FIXED, COMPOSITION: same as R454	745-0761-00
R460	RESISTOR, FIXED, COMPOSITION: 4700 ohms ±10%, 1/4 w; MIL type RC07GF472K	745-0773-00
R461	RESISTOR, FIXED, COMPOSITION: same as R460	745-0773-00
R462	RESISTOR, FIXED, COMPOSITION: same as R453	745-0809-00
R463	RESISTOR, FIXED, COMPOSITION: same as R453	745-0809-00
T450	TRANSFORMER, RADIO FREQUENCY: 5/8 in. by 1-3/8 in. by 1-3/8 in.	756-3902-003
T451	TRANSFORMER, RADIO FREQUENCY: 5/8 in. by 1-1/4 in. by 1-1/4 in.	756-3900-003
TP450	JACK, TIP: for use with standard 0.080 tip plug, double ended; white body; Amp, Inc. part no. 2-582120-9	360-0276-00
TP451	JACK, TIP: for use with standard 0.080 tip plug, double ended; black body; Amp, Inc. part no. 2-582120-0	360-0277-00
XQ450	SOCKET, TRANSISTOR: 3 contacts spaced on an 0.200 in. dia circle; Elco Corp. part no. 3307X	352-9903-00
XQ451	SOCKET, TRANSISTOR: same as XQ450	352-9903-00
AUDIO AMPLIFIER A10, A11		528-0439-00
C400	CAPACITOR, FIXED, ELECTROLYTIC: 20 uf, -10% +100% 25 v dc; Sprague Electric Co. part no. 40D181A2	183-1365-00

ITEM	DESCRIPTION	COLLINS PART NUMBER
C401	CAPACITOR, FIXED, ELECTROLYTIC: same as C400	183-1365-00
C402	CAPACITOR, FIXED, ELECTROLYTIC: same as C400	183-1365-00
C403	CAPACITOR, FIXED, ELECTROLYTIC: 250 uf -10% +100% 30 v dc; Sprague Electric part no. 4Y12B	183-1901-00
C404	CAPACITOR, FIXED, ELECTROLYTIC: same as C400	183-1365-00
C405	CAPACITOR, FIXED, ELECTROLYTIC: 100 uf -10% +100% 25 v dc; Sprague Electric part no. D34487	183-1192-00
C406	CAPACITOR, FIXED, ELECTROLYTIC: same as C400	183-1365-00
C407	CAPACITOR, FIXED, PAPER: 0.015 uf ±20%, 600 v dc; Sprague Electric part no. 160P15306	931-5502-00
C408	CAPACITOR, FIXED, ELECTROLYTIC: same as C405	183-1192-00
C409	CAPACITOR, FIXED, ELECTROLYTIC: same as C403	183-1901-00
Q400	TRANSISTOR: germanium; hermetically sealed; Sylvania part no. 2N526	352-0123-00
Q401	TRANSISTOR: same as Q400	352-0123-00
Q402	TRANSISTOR: same as Q400	352-0123-00
R400	RESISTOR, FIXED, FILM: 19600 ohms ±1%, 1/4 w; MIL type RN65B1962F	705-7158-00
R401	RESISTOR, FIXED, FILM: 34800 ohms ±1%, 1/4 w; MIL type RN65B3482F	705-7170-00
R402	RESISTOR, FIXED, COMPOSITION: 2,200 ohms ±10%, 1/4 w; MIL type RC07GF222K	745-0761-00
R403	RESISTOR, FIXED, COMPOSITION: 470 ohms ±10%, 1/4 w; MIL type RC07GF471K	745-0737-00
R404	RESISTOR, FIXED, FILM: 4220 ohms ±1%, 1/4 w; MIL type RN65B4221F	705-7126-00
R405	RESISTOR, FIXED, COMPOSITION: 1,000 ohms ±10%, 1/4 w; MIL type RC07GF102K	745-0749-00
R406	RESISTOR, FIXED, FILM: 42,200 ohms ±1%, 1/4 w; MIL type RN65B4222F	705-7174-00
R407	RESISTOR, FIXED, FILM: 23,700 ohms ±1%, 1/4 w; MIL type RN65B2372F	705-7162-00
R408	RESISTOR, FIXED, COMPOSITION: 6,800 ohms ±10%, 1/4 w; MIL type RC07GF682K	745-0779-00
R409	RESISTOR, FIXED, COMPOSITION: 680 ohms ±10%, 1/4 w; MIL type RC07GF681K	745-0743-00
R410	RESISTOR, FIXED, FILM: same as R404	705-7126-00
R411	RESISTOR, FIXED, COMPOSITION: same as R405	745-0749-00
R412	RESISTOR, FIXED, COMPOSITION: 39,000 ohms ±10%, 1/4 w; MIL type RC07GF393K	745-0806-00
R413	RESISTOR, FIXED, COMPOSITION: 0.10 meg-ohm, ±10%, 1/4 w; MIL type RC07GF104K	745-0821-00
R414	RESISTOR, FIXED, COMPOSITION: same as R402	745-0761-00
R415	RESISTOR, FIXED, COMPOSITION: 220 ohms ±10%, 1/4 w; MIL type RC07GF221K	745-0725-00
R416	RESISTOR, FIXED, COMPOSITION: 10,000 ohms ±10%, 1/4 w; MIL type RC07GF103K	745-0785-00
TP400	JACK, TIP: for use with standard 0.080 tip plug, double ended; white body; Amp, Inc. part no. 2-582120-9	360-0276-00
TP401	JACK, TIP: for use with standard 0.080 tip plug, double ended; black body; Amp, Inc. part no. 2-582120-0	360-0277-00
XQ400	SOCKET, TRANSISTOR: 3 contacts spaced on an 0.200 in. dia circle, Elco Corp. part no. 3307X	352-9903-00
XQ401	SOCKET, TRANSISTOR: same as XQ400	352-9903-00
XQ402	SOCKET, TRANSISTOR: same as XQ400	352-9903-00

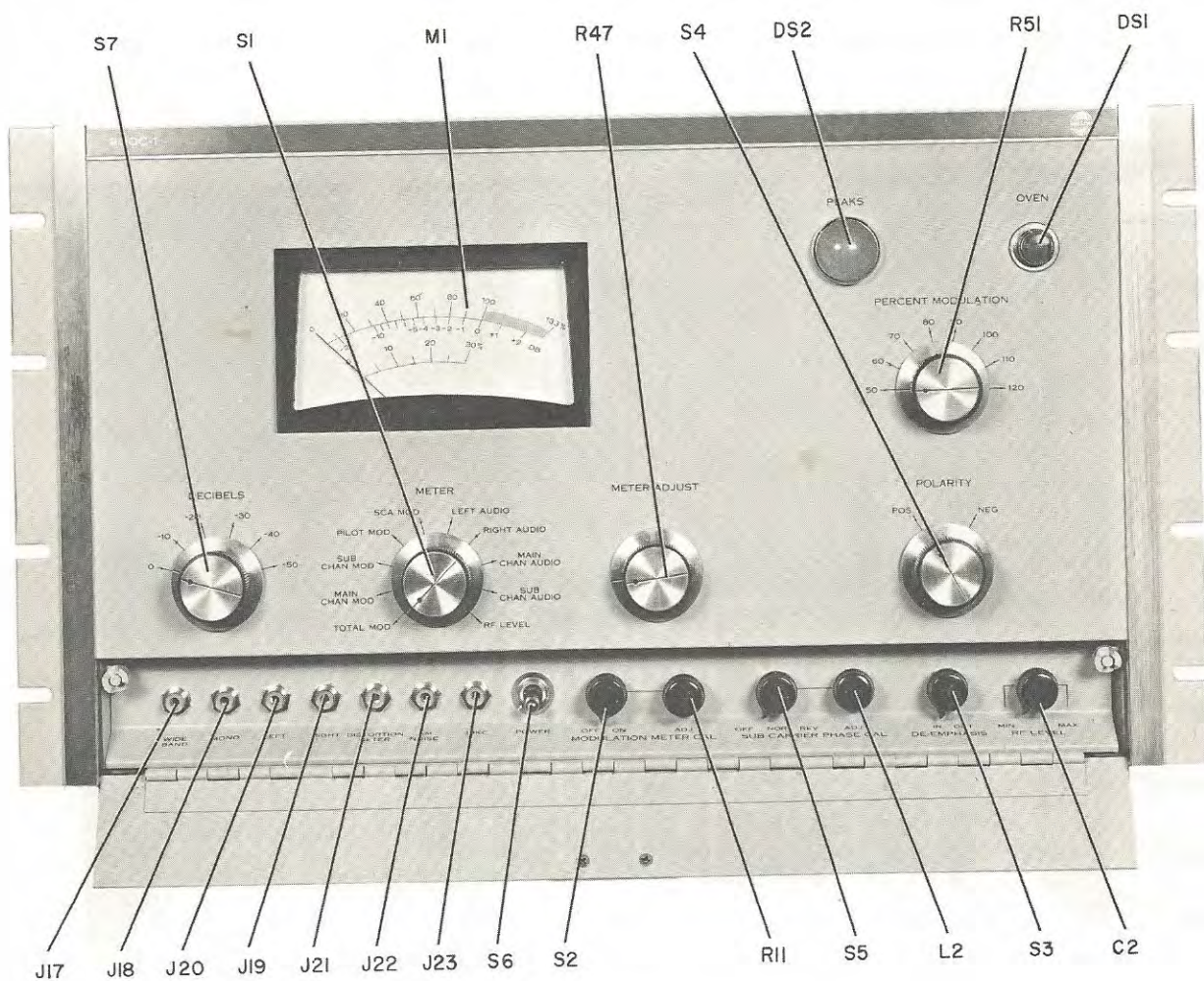

Figure 6-1. Front View, Parts Location

SECTION 6
Parts List

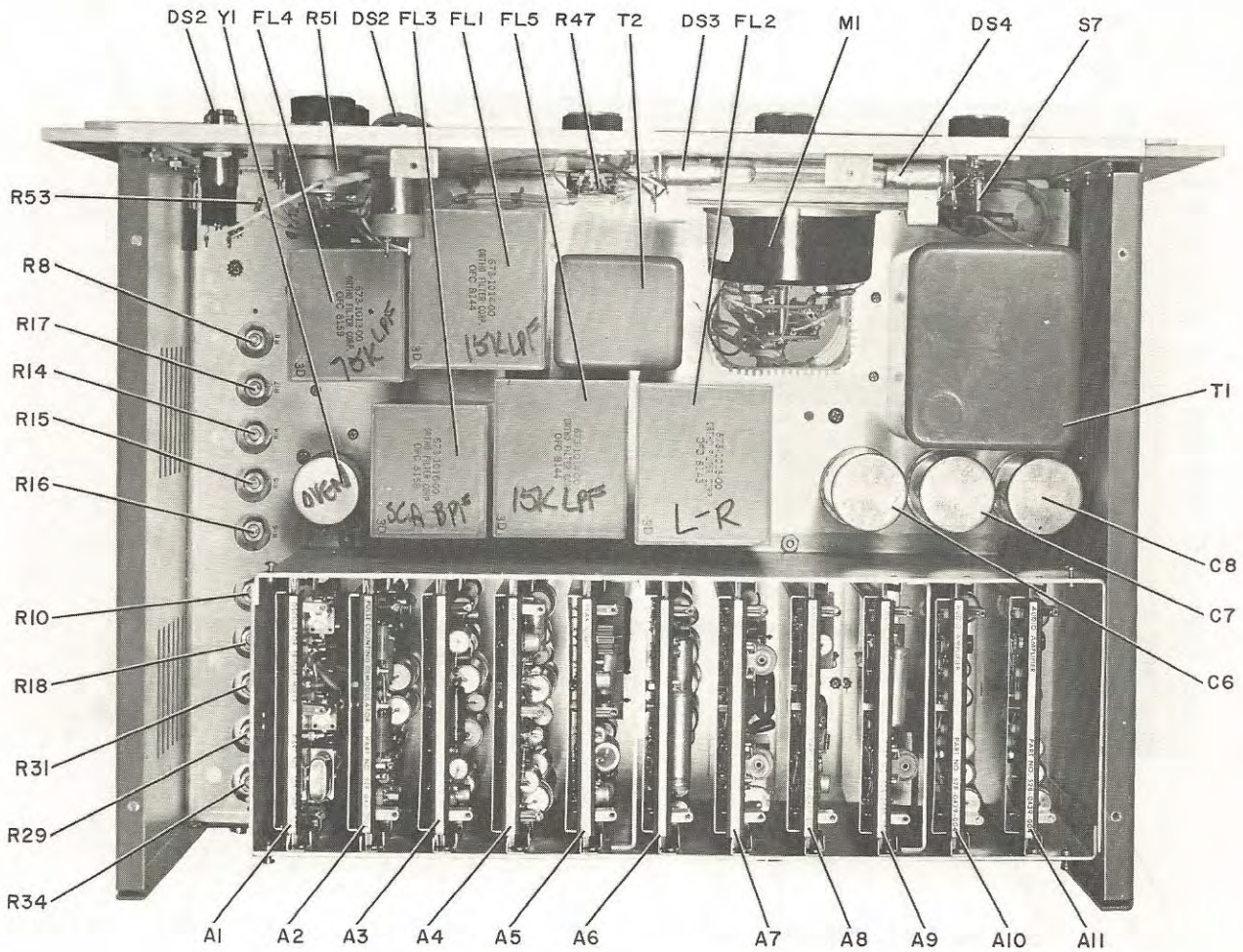

Figure 6-2. Top View, Parts Location

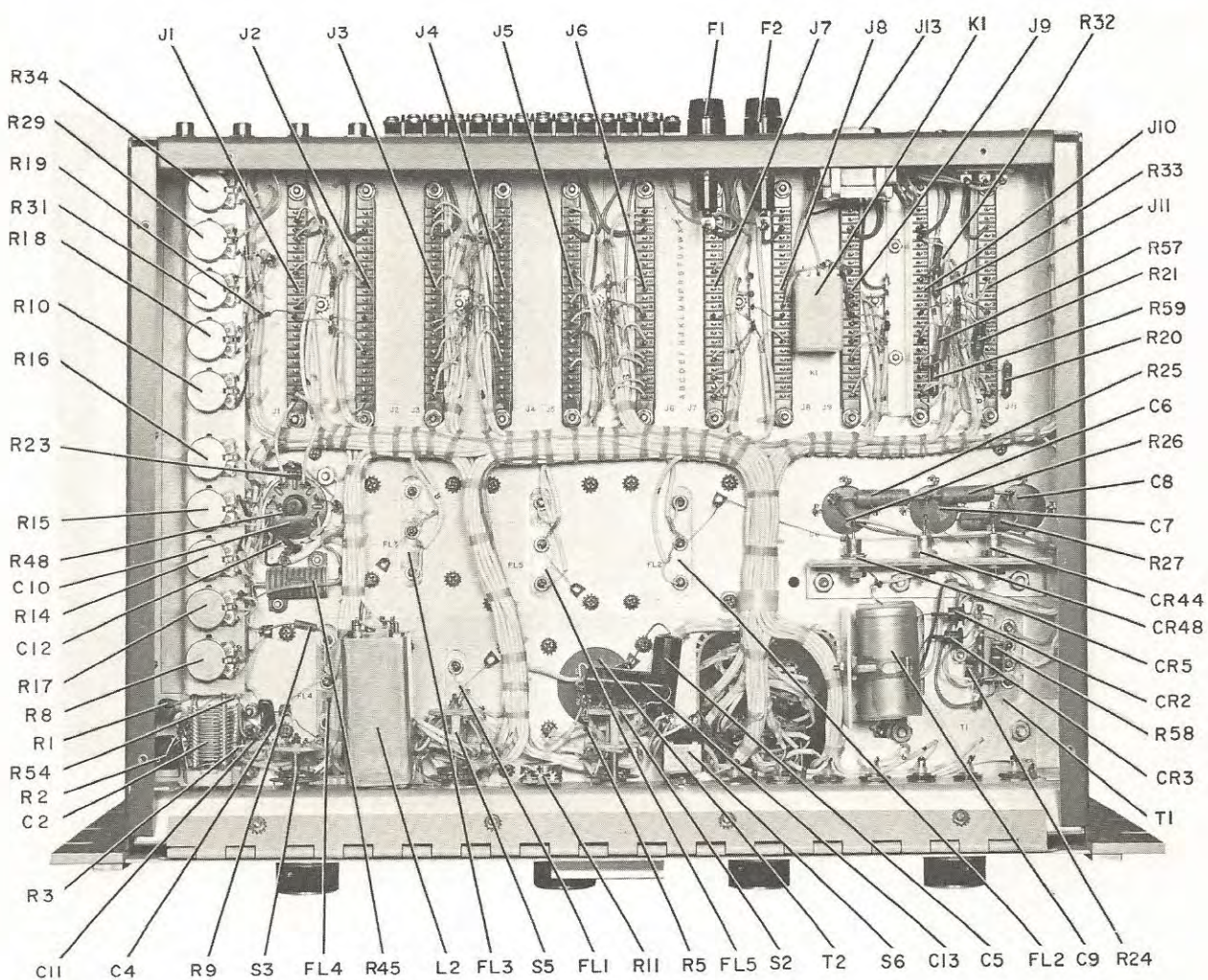

Figure 6-3. Bottom View, Parts Location

SECTION 6
Parts List

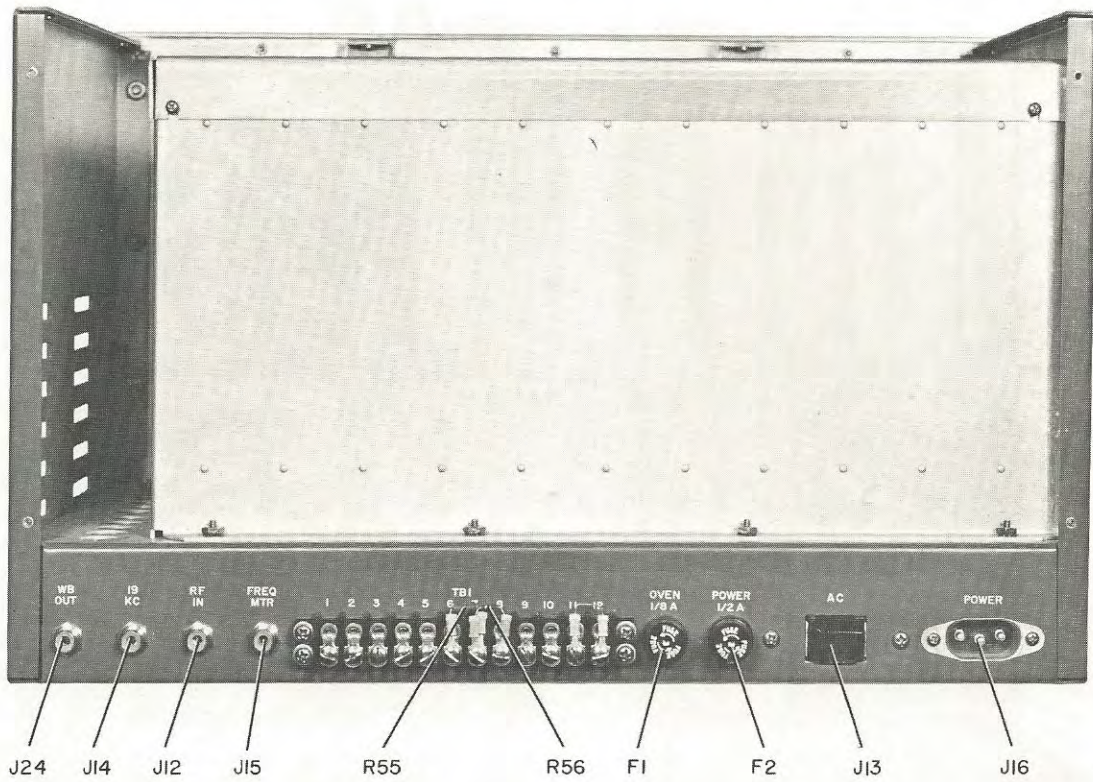

Figure 6-4. Rear View, Parts Location

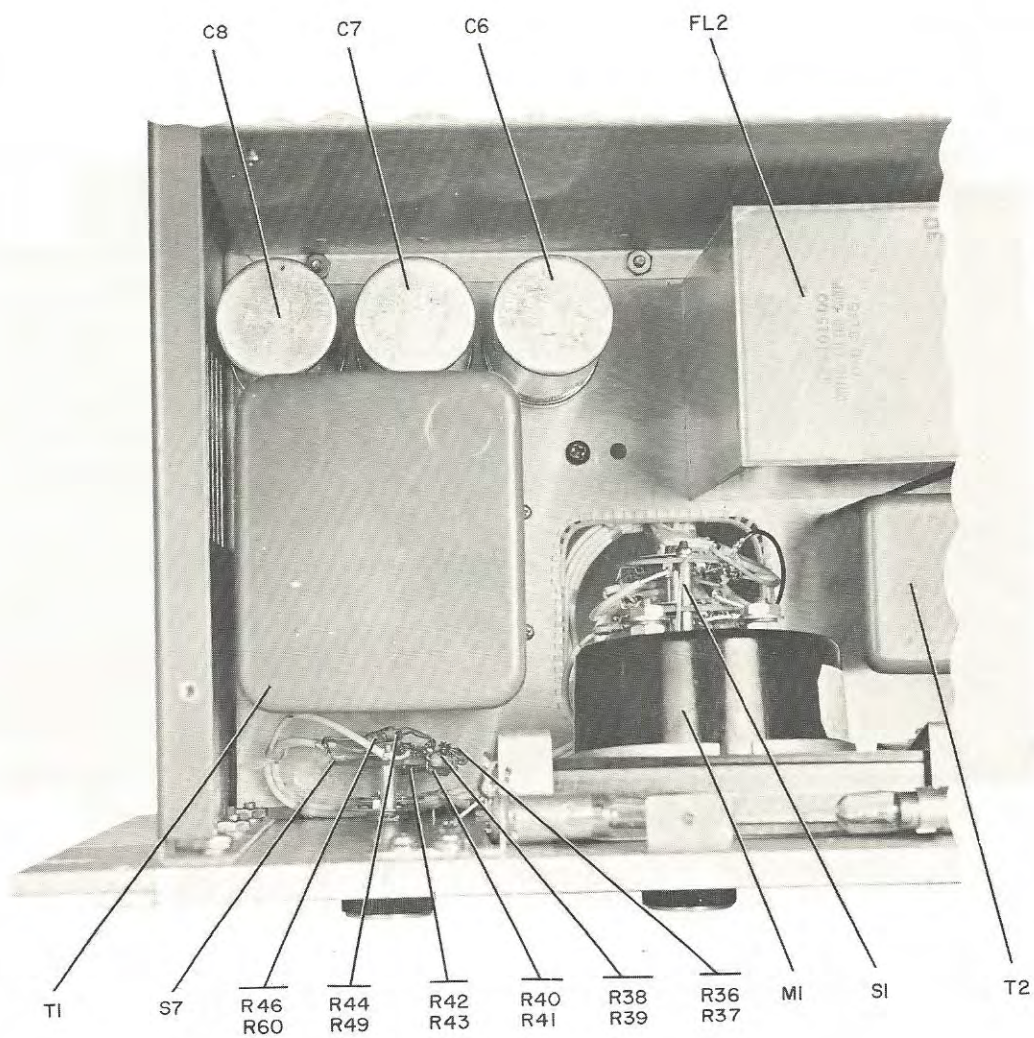

Figure 6-5. Left Side View, Parts Location

SECTION 6
Parts List

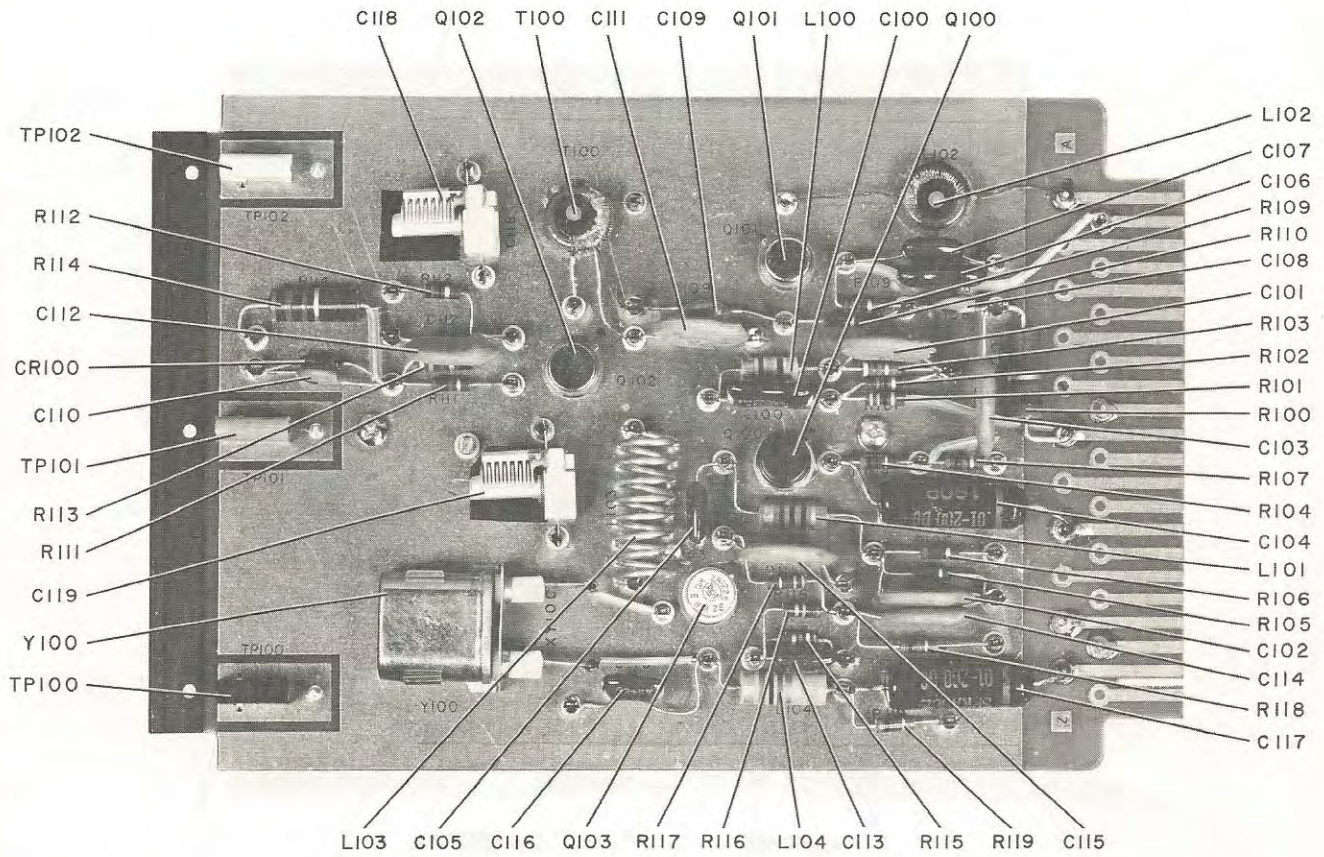

Figure 6-6. Oscillator-Tripler-Mixer A1, Parts Location

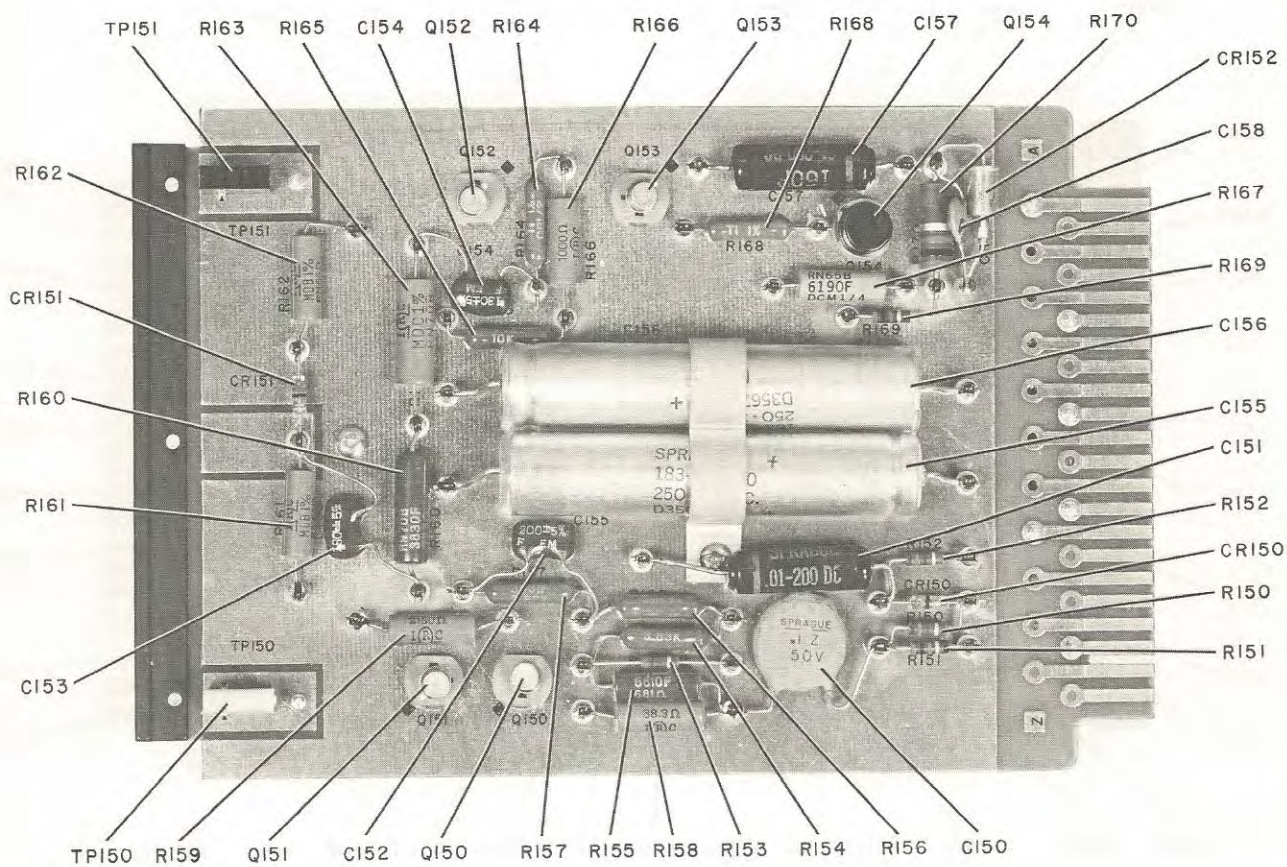

Figure 6-7. Pulse Counting Demodulator A2, Parts Location

SECTION 6
Parts List

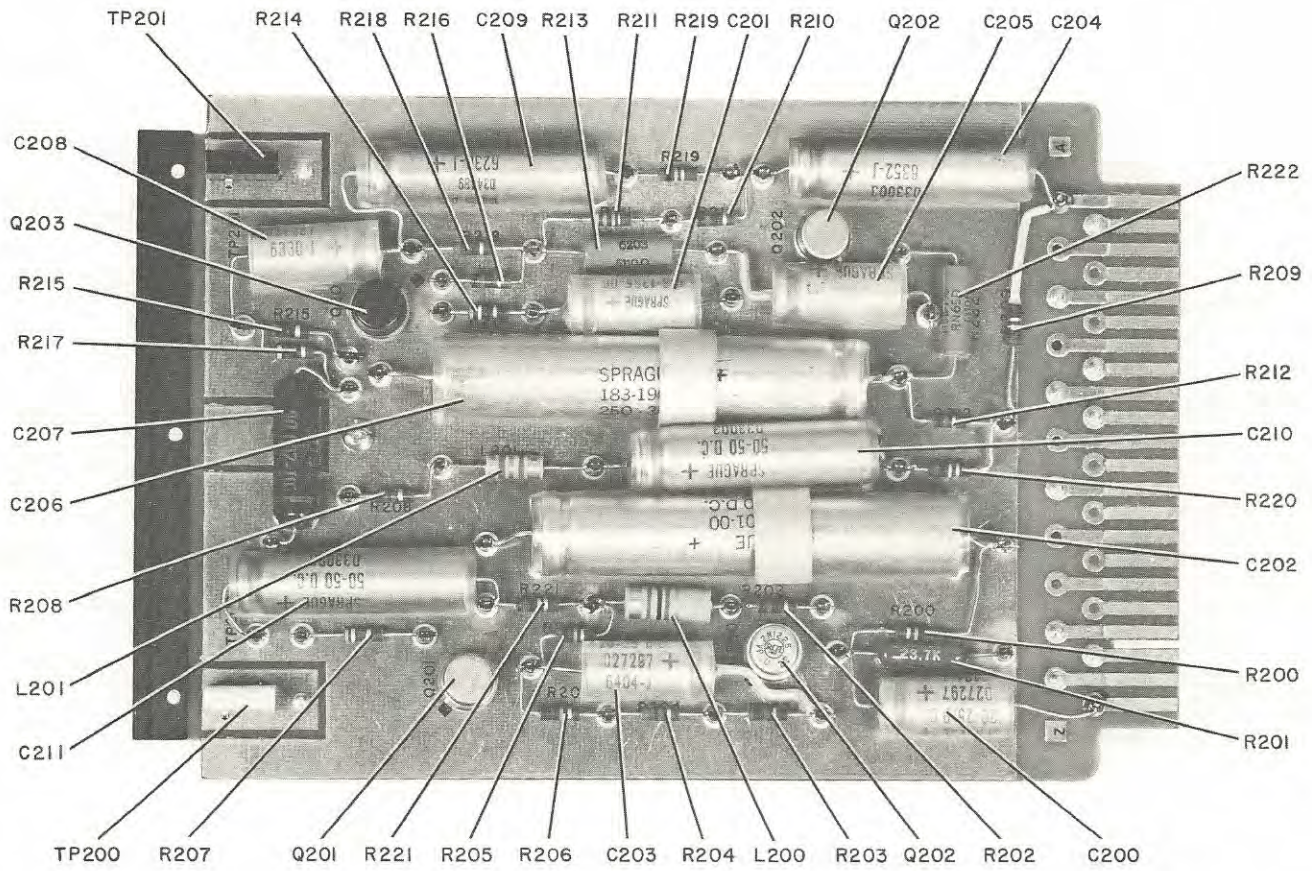

Figure 6-8. Phase Splitter A3, Parts Location

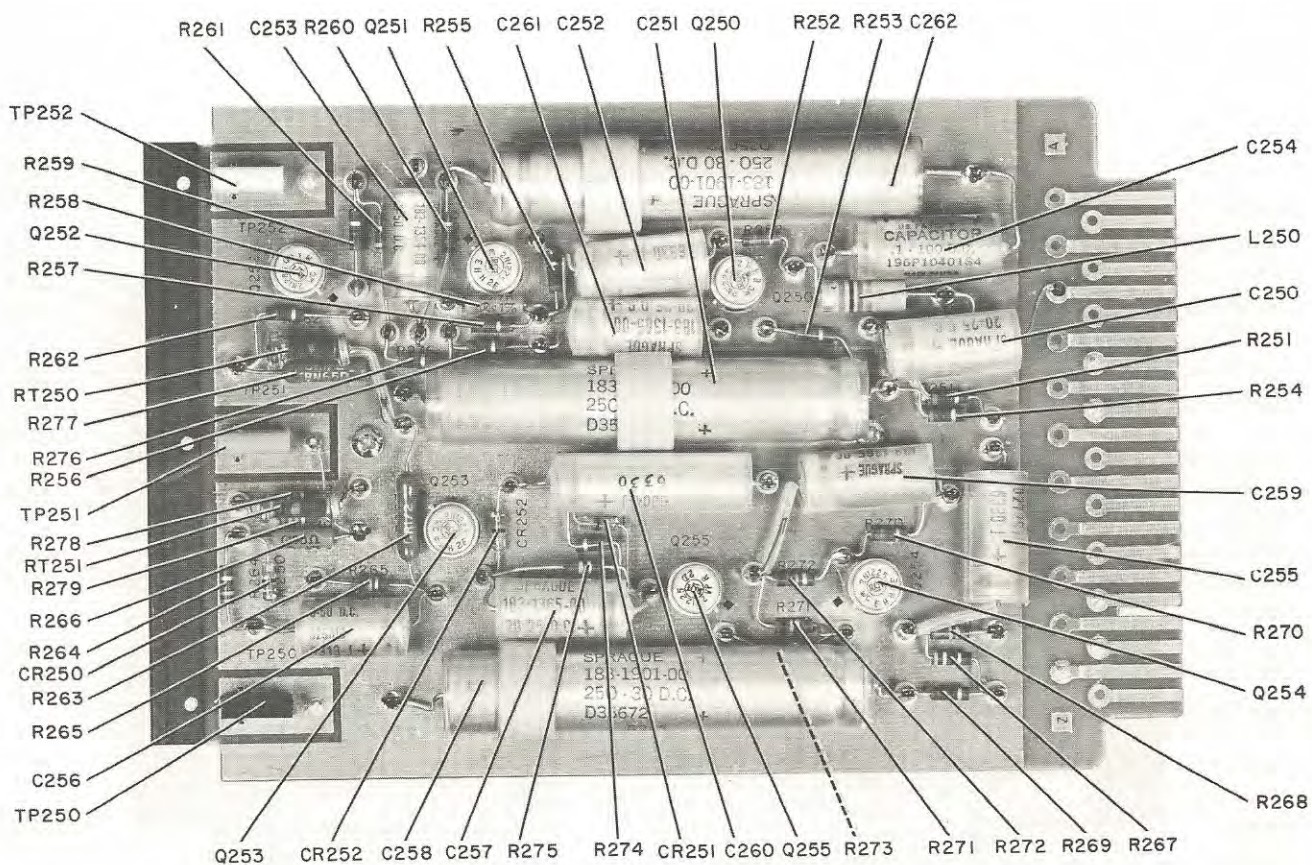

Figure 6-9. Peak Voltmeter A4, Parts Location

SECTION 6
Parts List

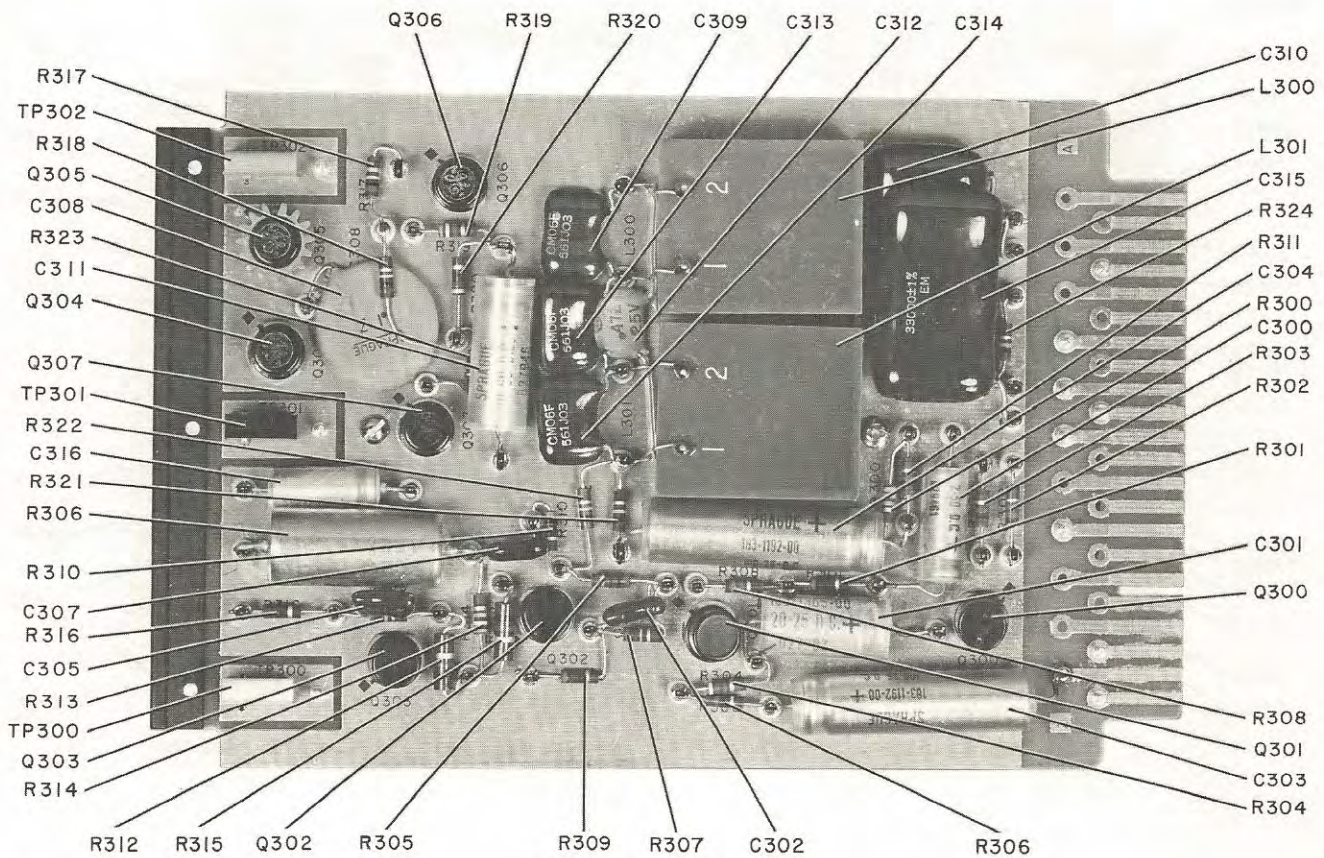

Figure 6-10. Peak Light A5, Parts Location

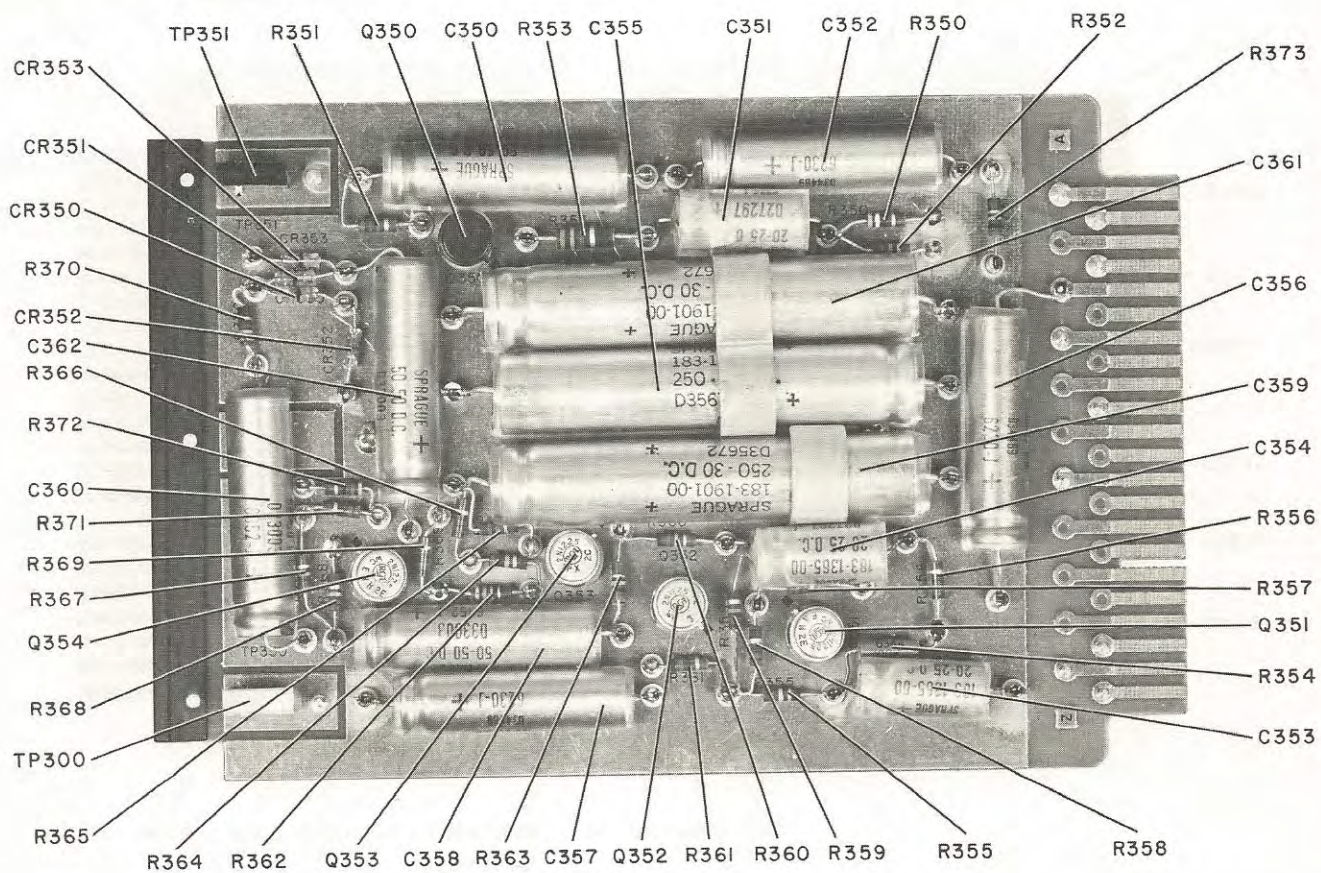

Figure 6-11. Average Voltmeter A6, Parts Location

SECTION 6
Parts List

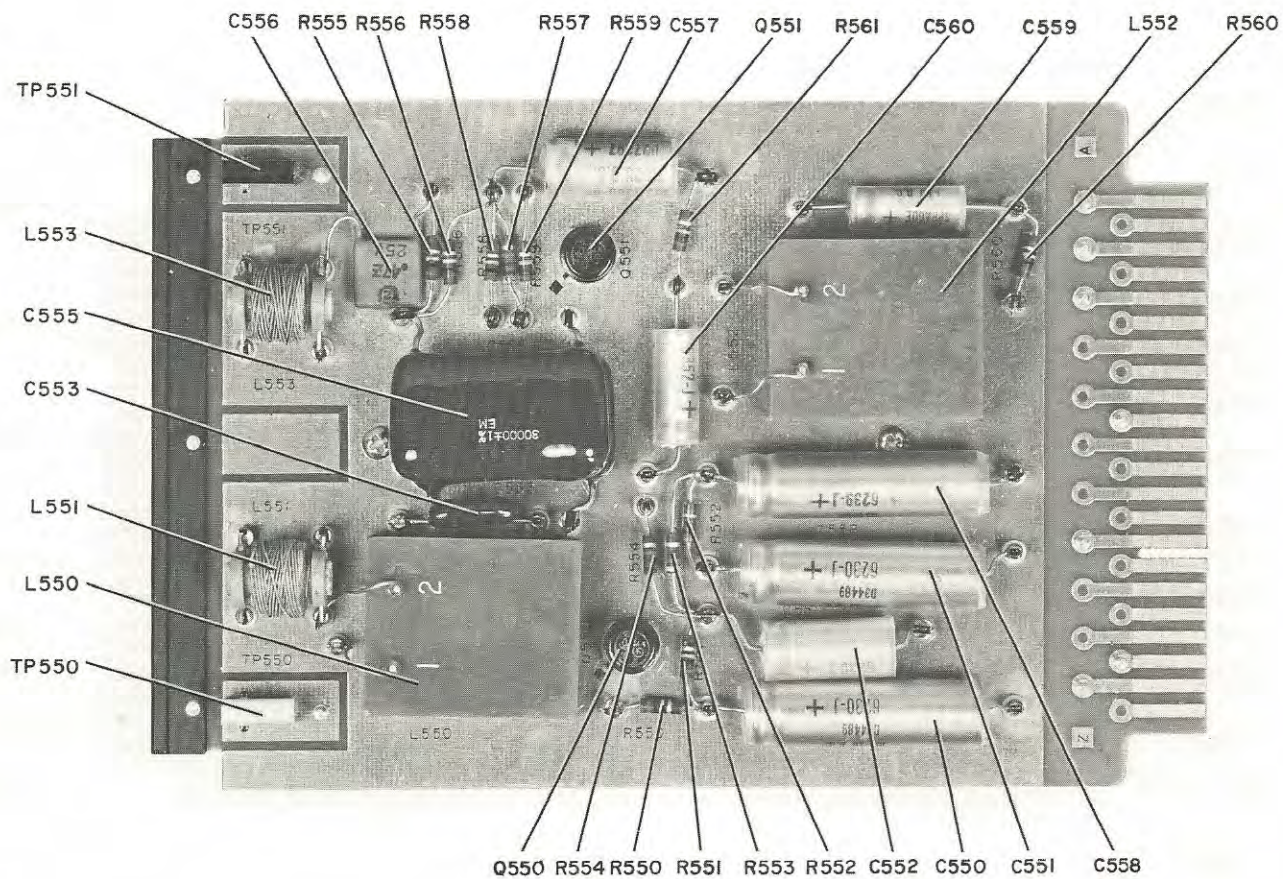

Figure 6-12. 19-Kc Amplifier A7, Parts Location

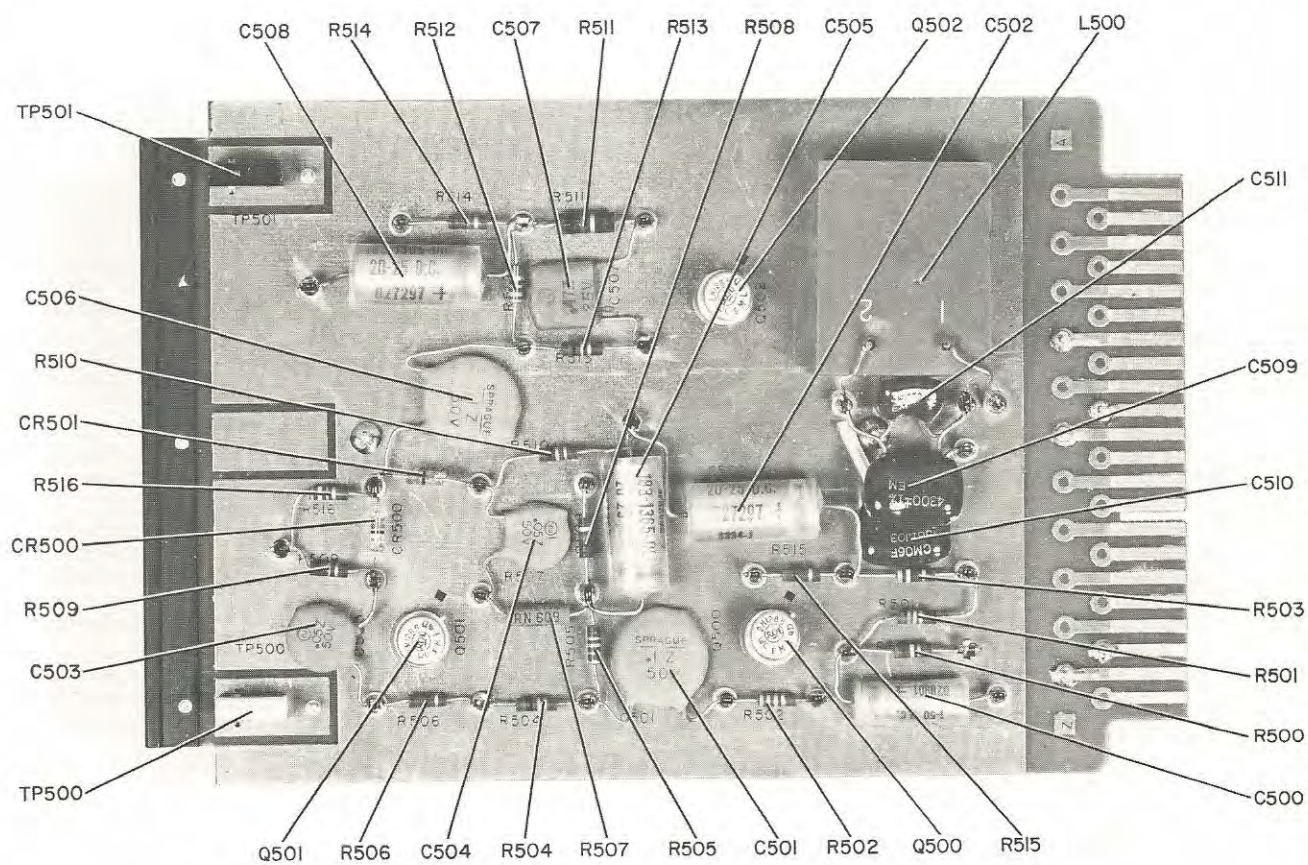

Figure 6-13. Amplifier Doubler A8, Parts Location

SECTION 6
Parts List

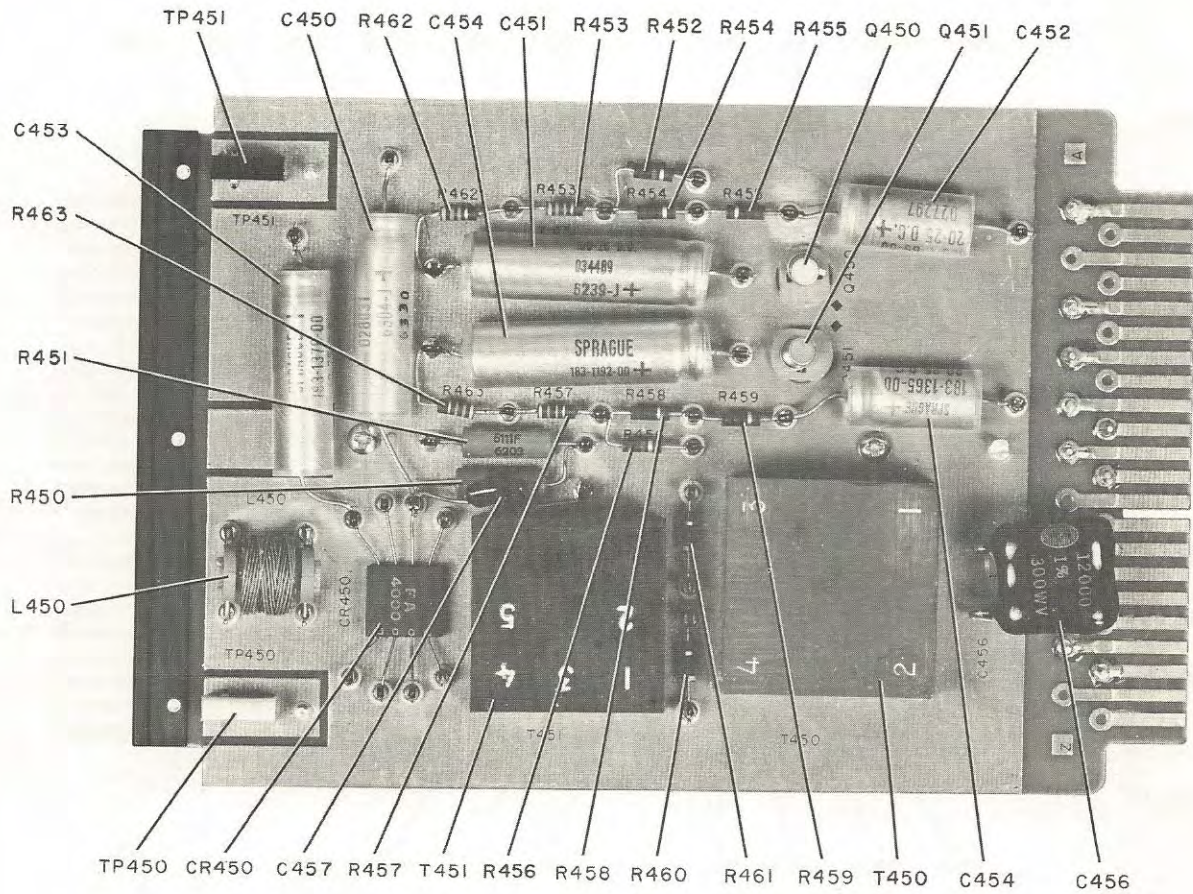

Figure 6-14. Stereo Demodulator A9, Parts Location

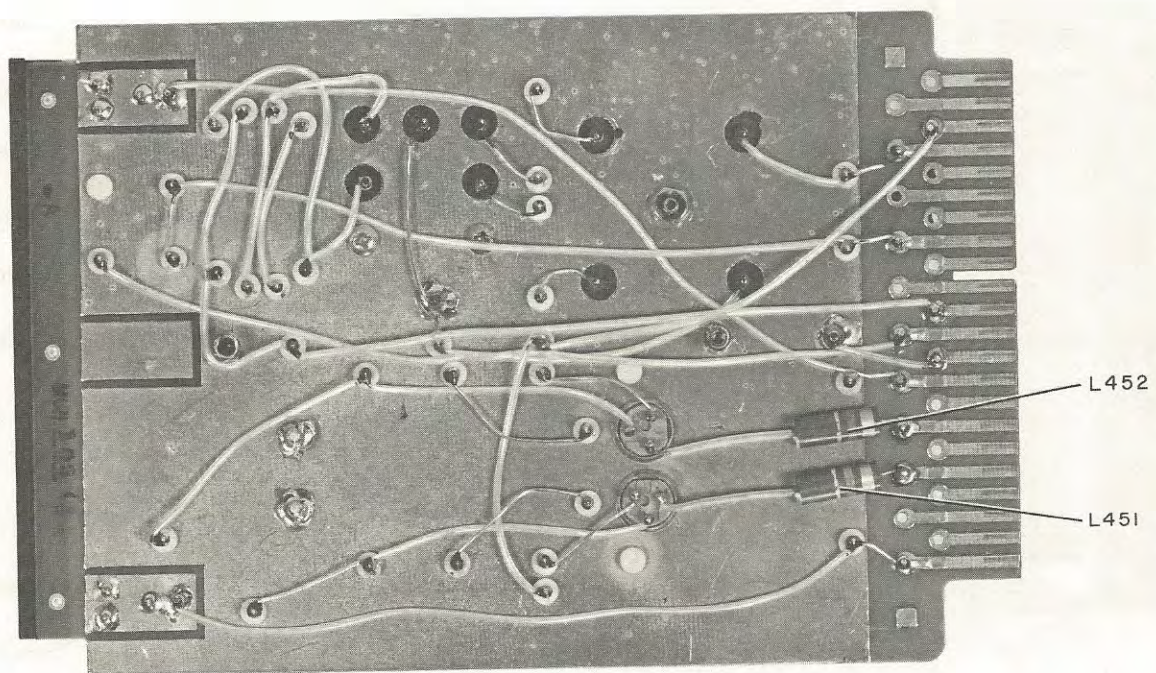

Figure 6-15. Stereo Demodulator A9, Rear View with Shield Removed, Parts Location

SECTION 6
Parts List

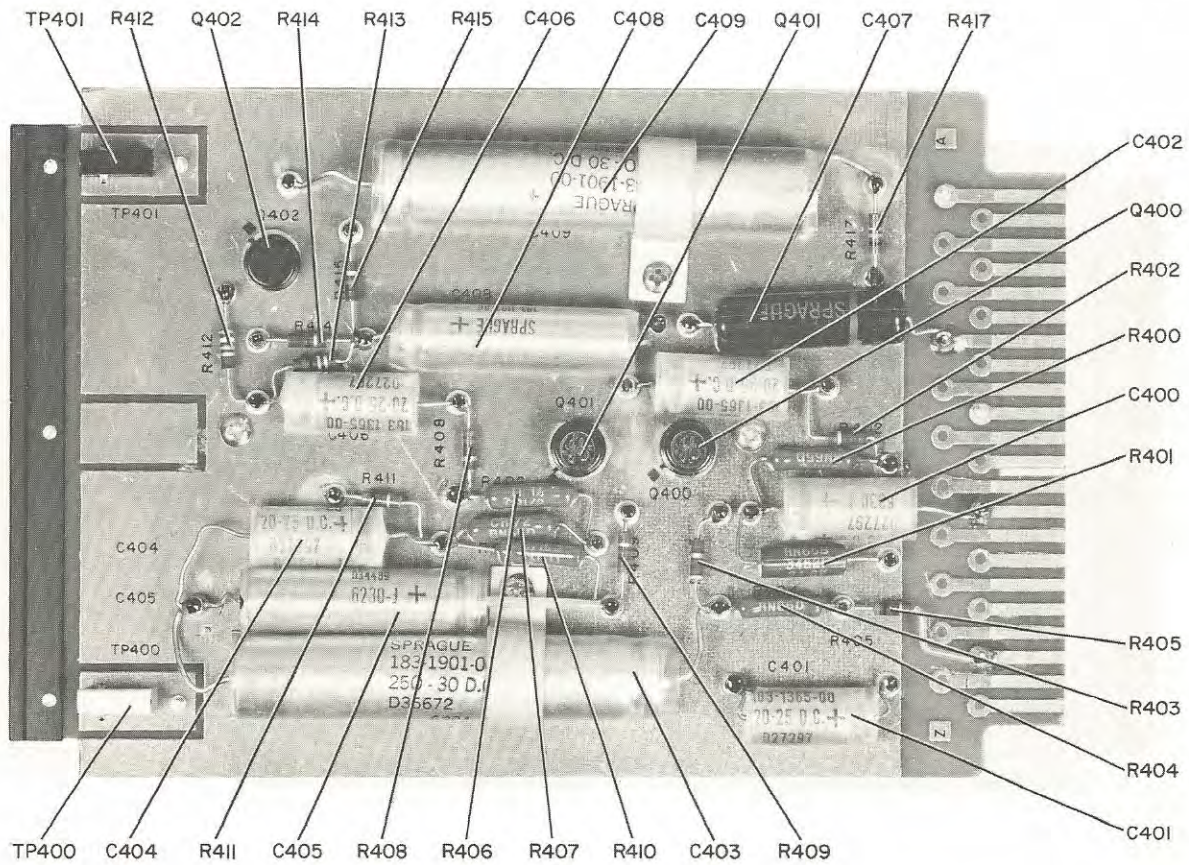

Figure 6-16. Audio Amplifier A10, Parts Location

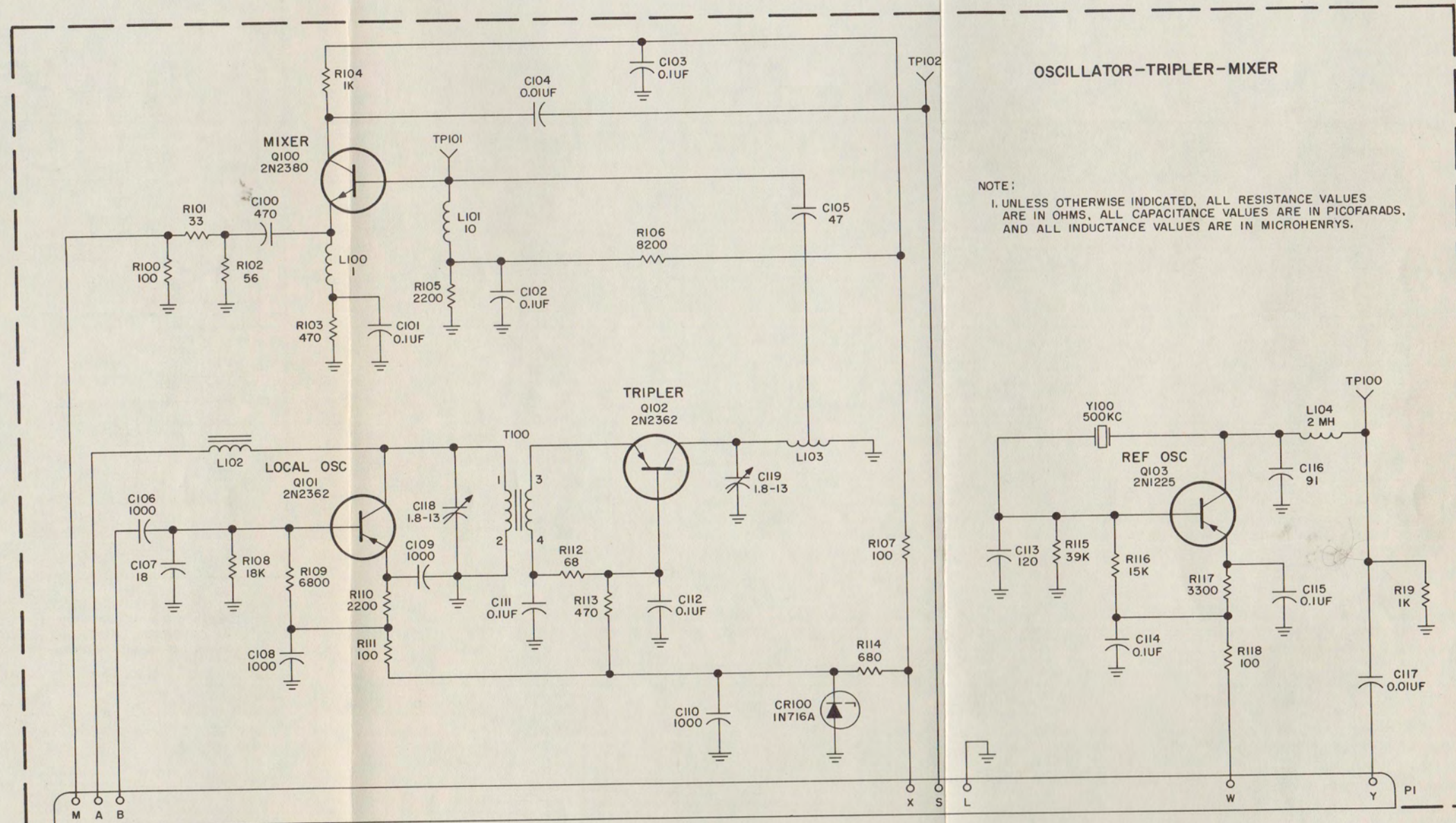
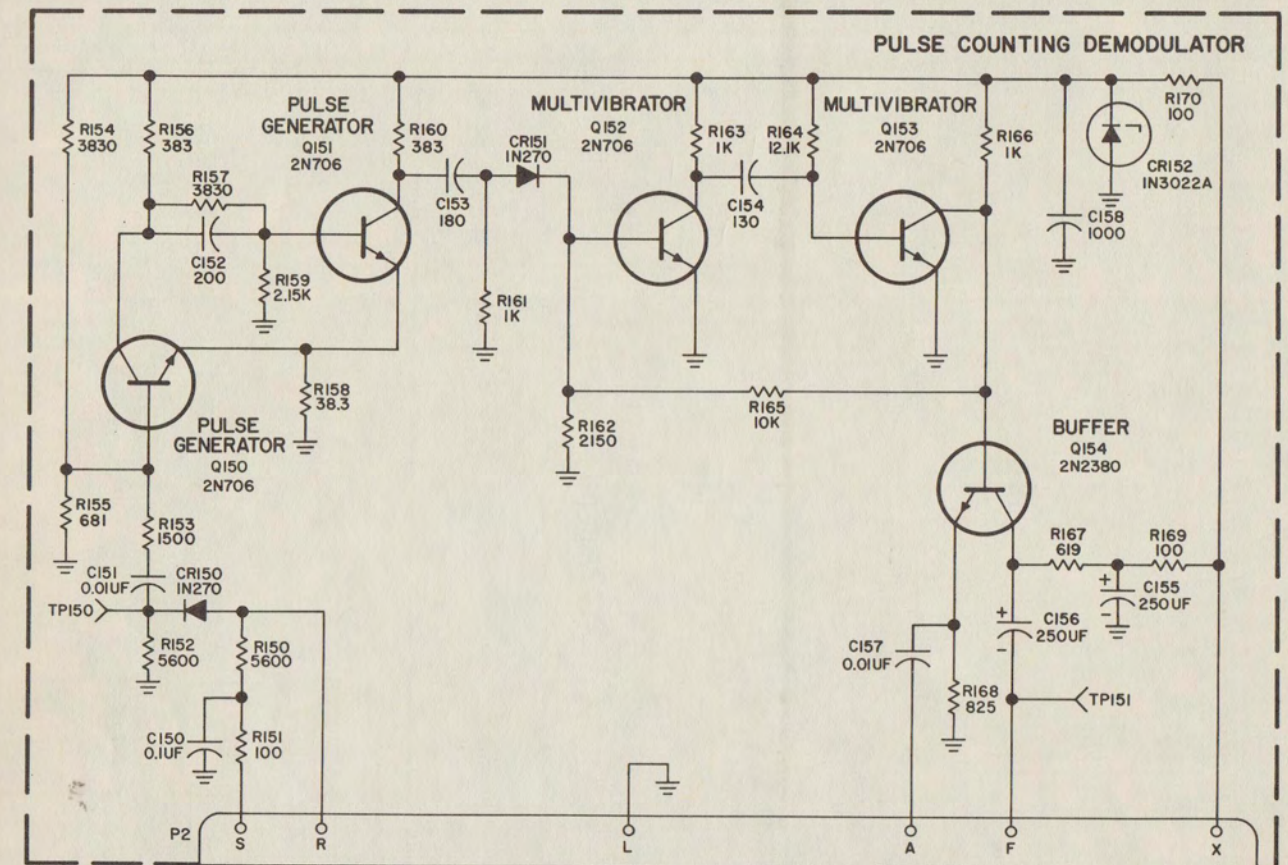

Figure 7-1. Oscillator-Tripler-Mixer Card A1, Schematic Diagram

If You Didn't Get This From My Site,
Then It Was Stolen From...
www.SteamPoweredRadio.Com



NOTE:
UNLESS OTHERWISE INDICATED, ALL RESISTANCE VALUES ARE IN OHMS,
ALL CAPACITANCE VALUES ARE IN PICOFARADS, AND ALL INDUCTANCE
VALUES ARE IN MICROHENRYS.

Figure 7-2. Pulse Counting Demodulator Card A2, Schematic Diagram

If You Didn't Get This From My Site,
Then It Was Stolen From...
www.SteamPoweredRadio.Com

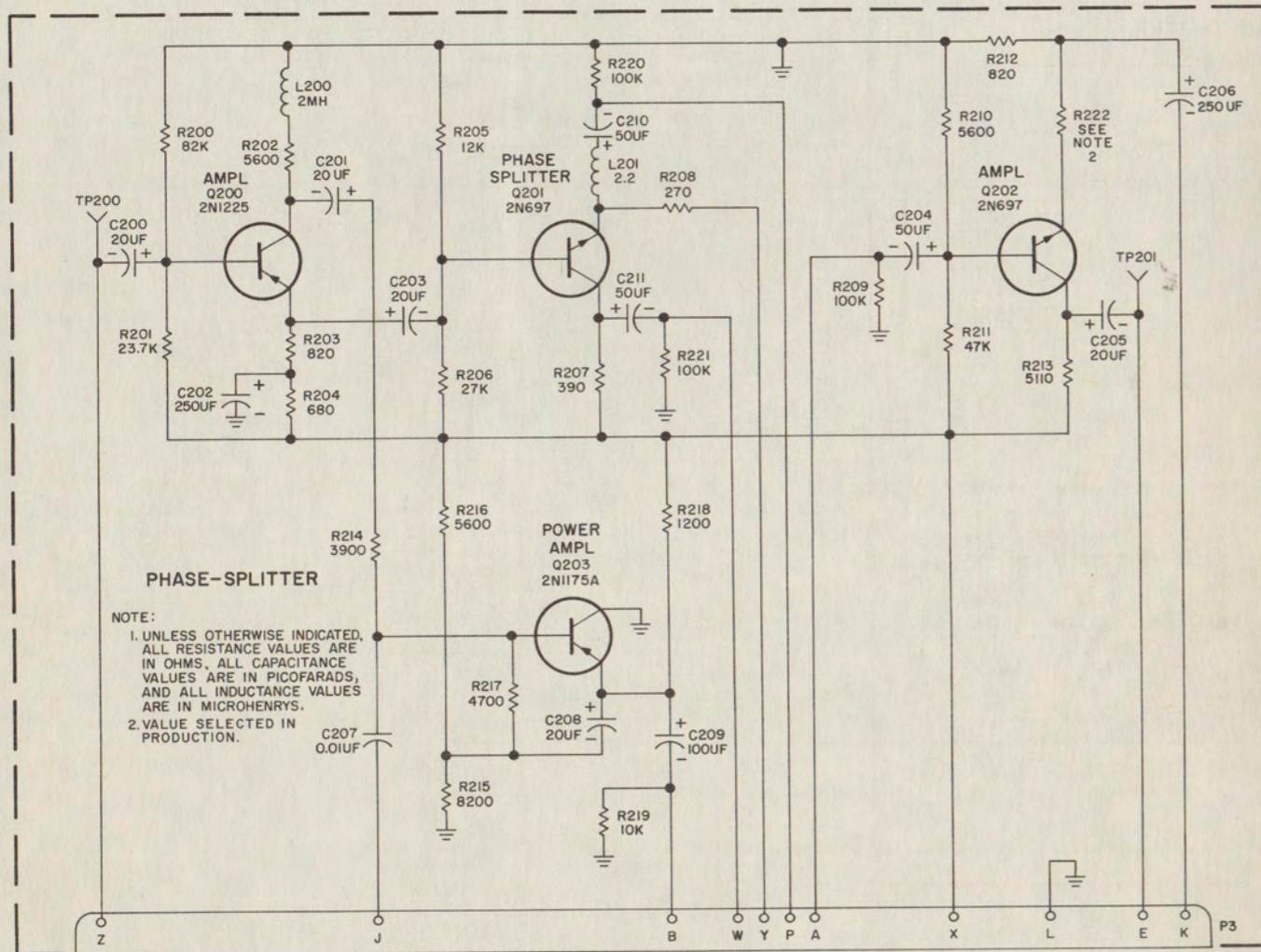
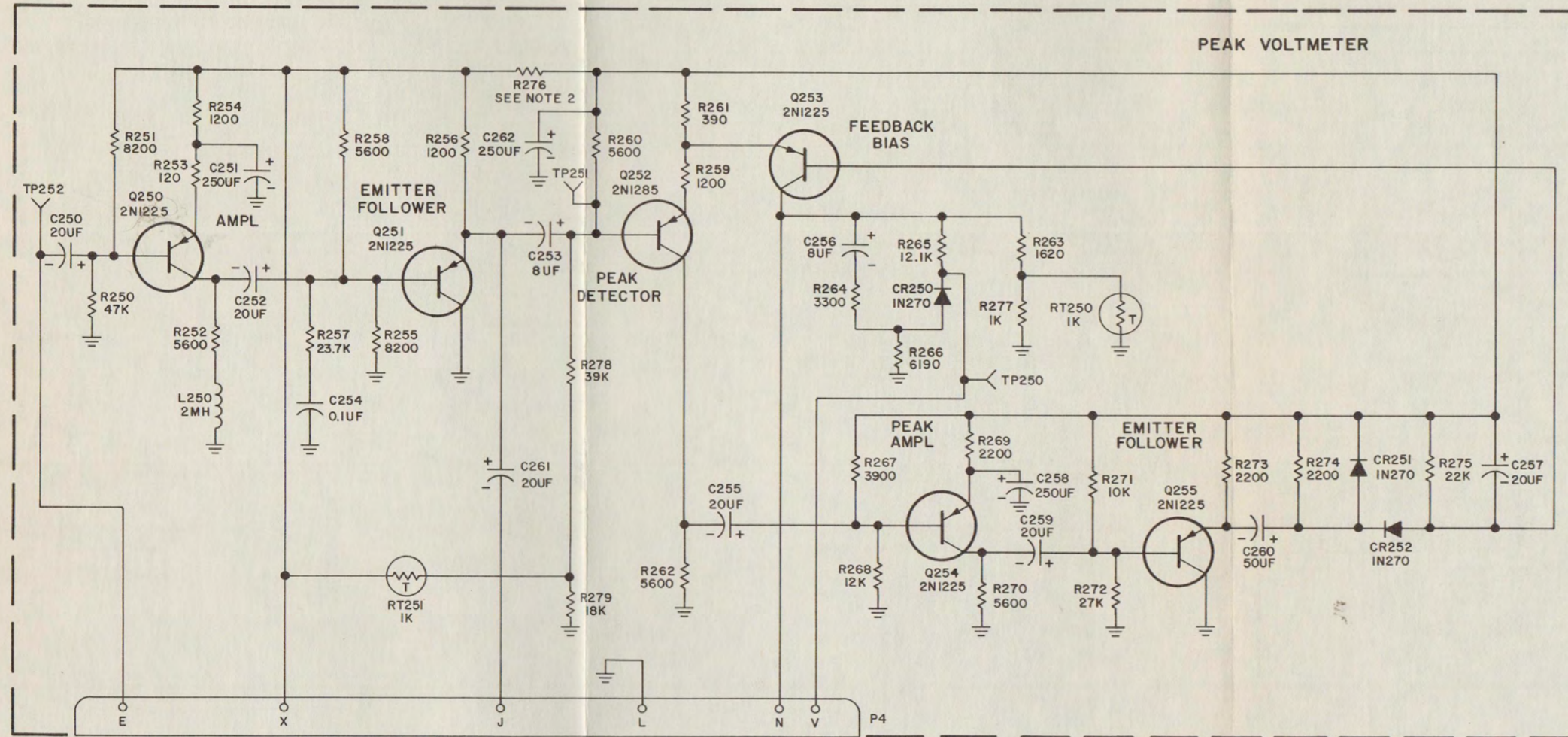
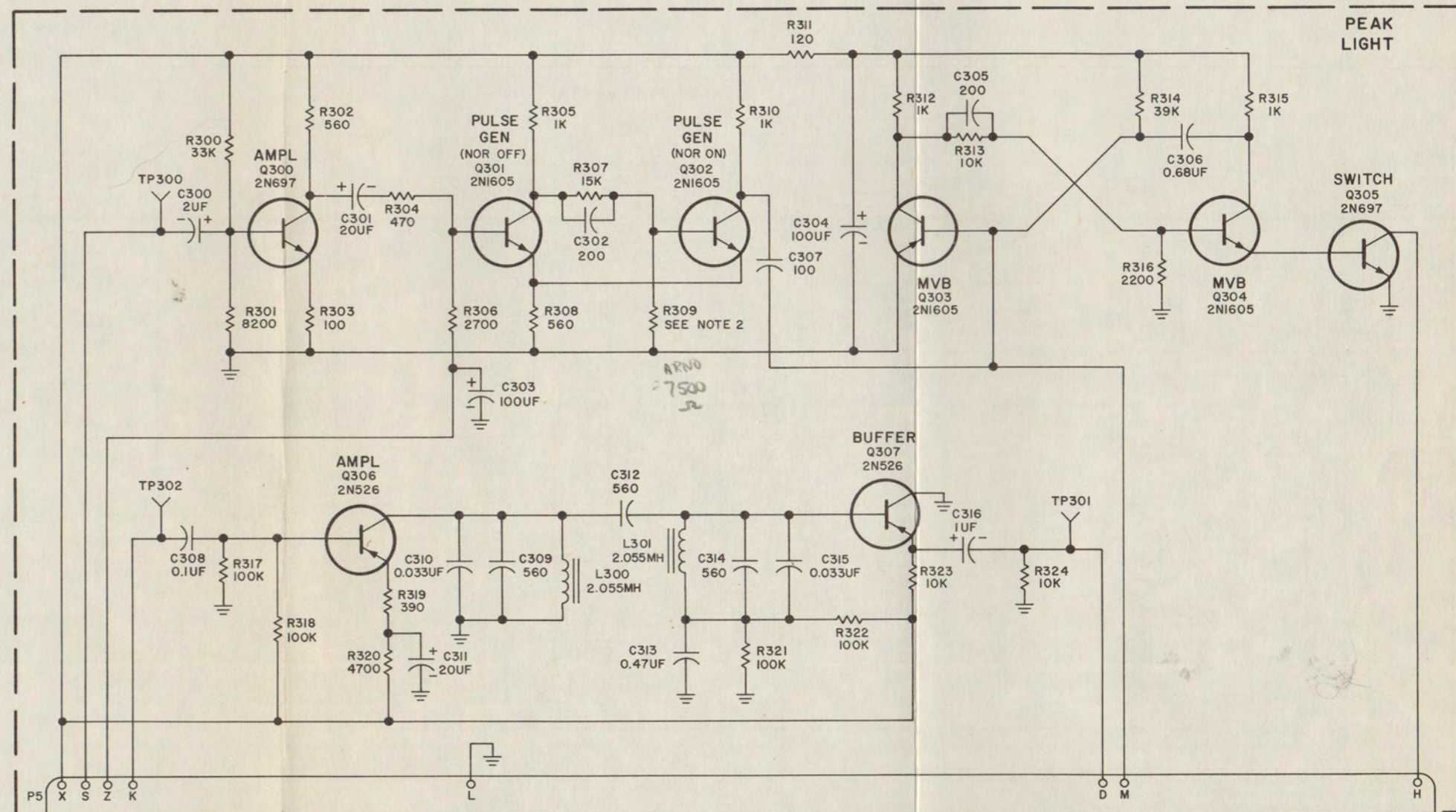

Figure 7-3. Phase Splitter Card A3, Schematic Diagram



NOTES:
 1. UNLESS OTHERWISE INDICATED ALL RESISTANCE VALUES ARE IN OHMS, ALL CAPACITANCE VALUES ARE IN PICOFARADS AND ALL INDUCTANCE VALUES ARE IN MICROHENRYS.
 2. VALUE SELECTED IN PRODUCTION.

Figure 7-4. Peak Voltmeter Card A4, Schematic Diagram



NOTE:

1. UNLESS OTHERWISE INDICATED ALL RESISTANCE VALUES ARE IN OHMS, ALL CAPACITANCE VALUES ARE IN PICOFARADS, AND ALL INDUCTANCE VALUES ARE IN MICROHENRYS.
2. VALUE SELECTED IN PRODUCTION.

If You Didn't Get This From My Site,
Then It Was Stolen From...
www.SteamPoweredRadio.Com

Figure 7-5. Peak Light Card A5, Schematic Diagram

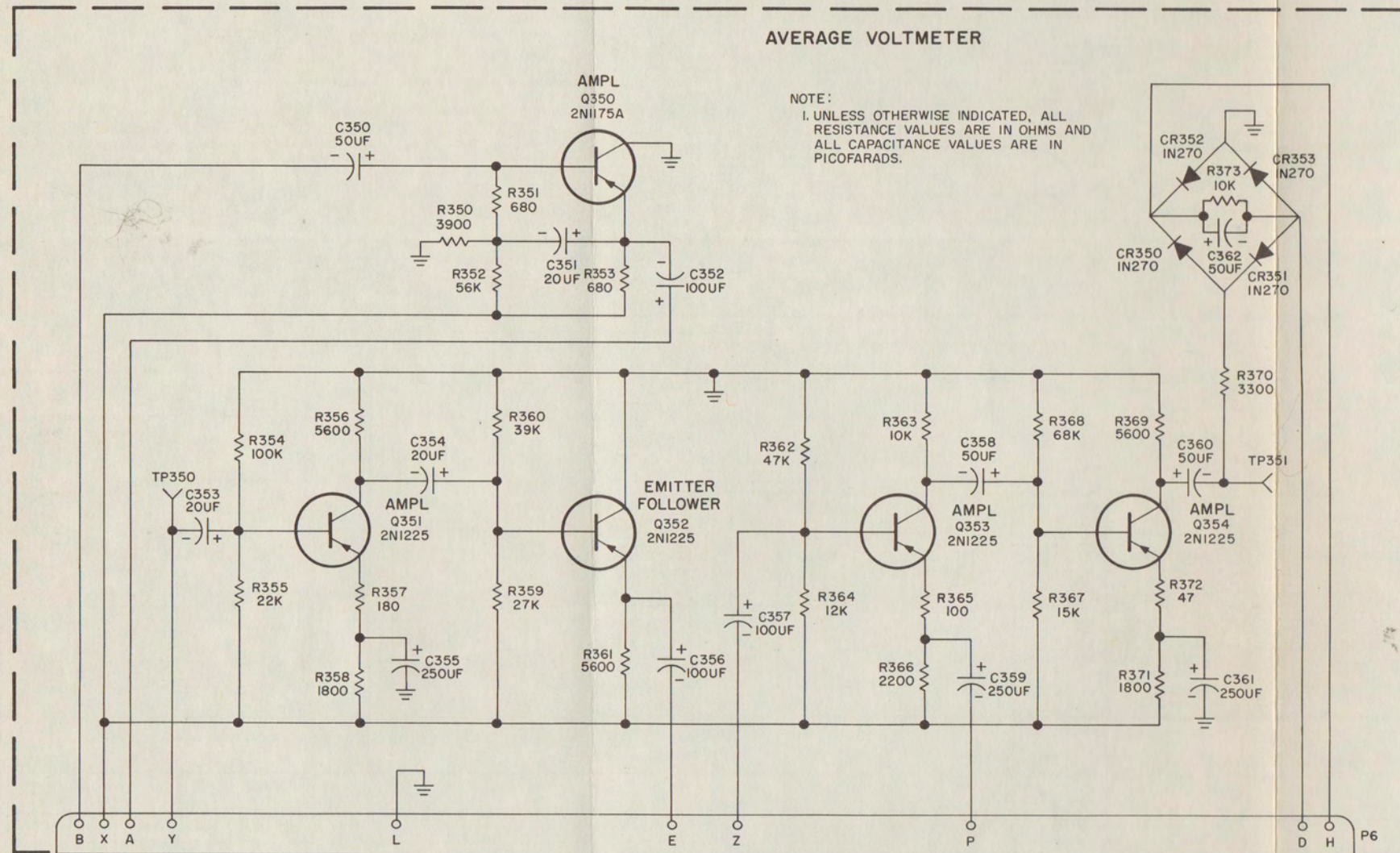
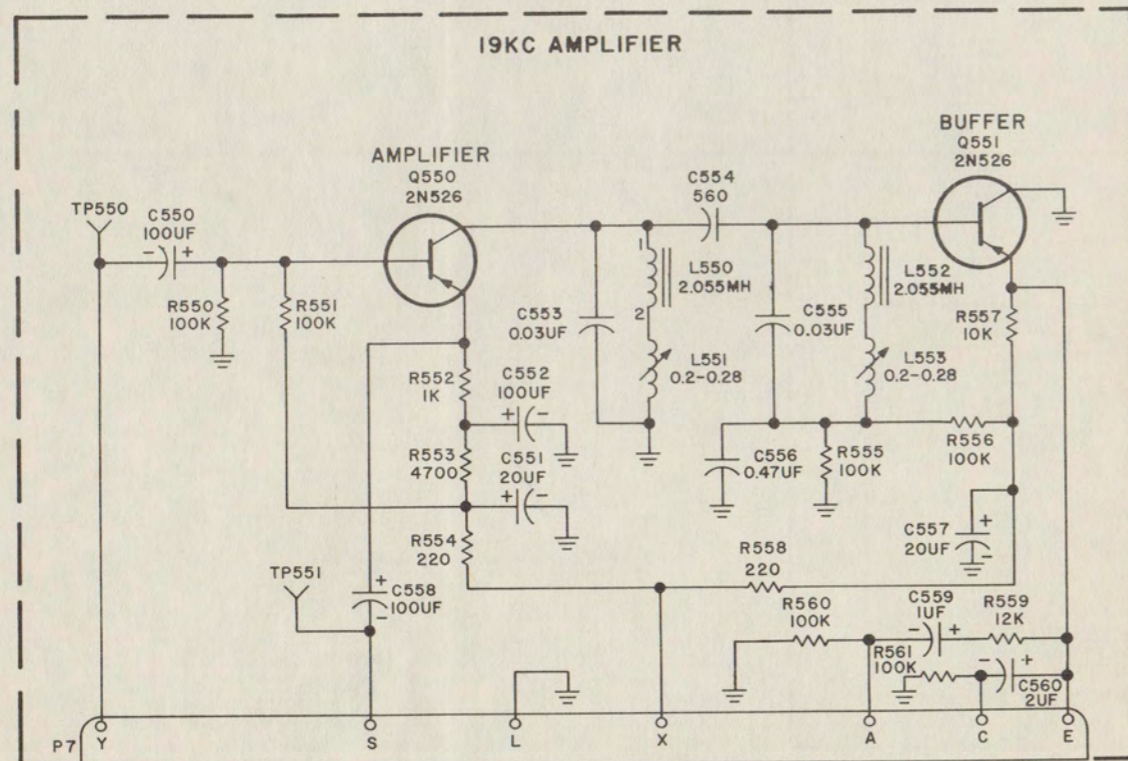
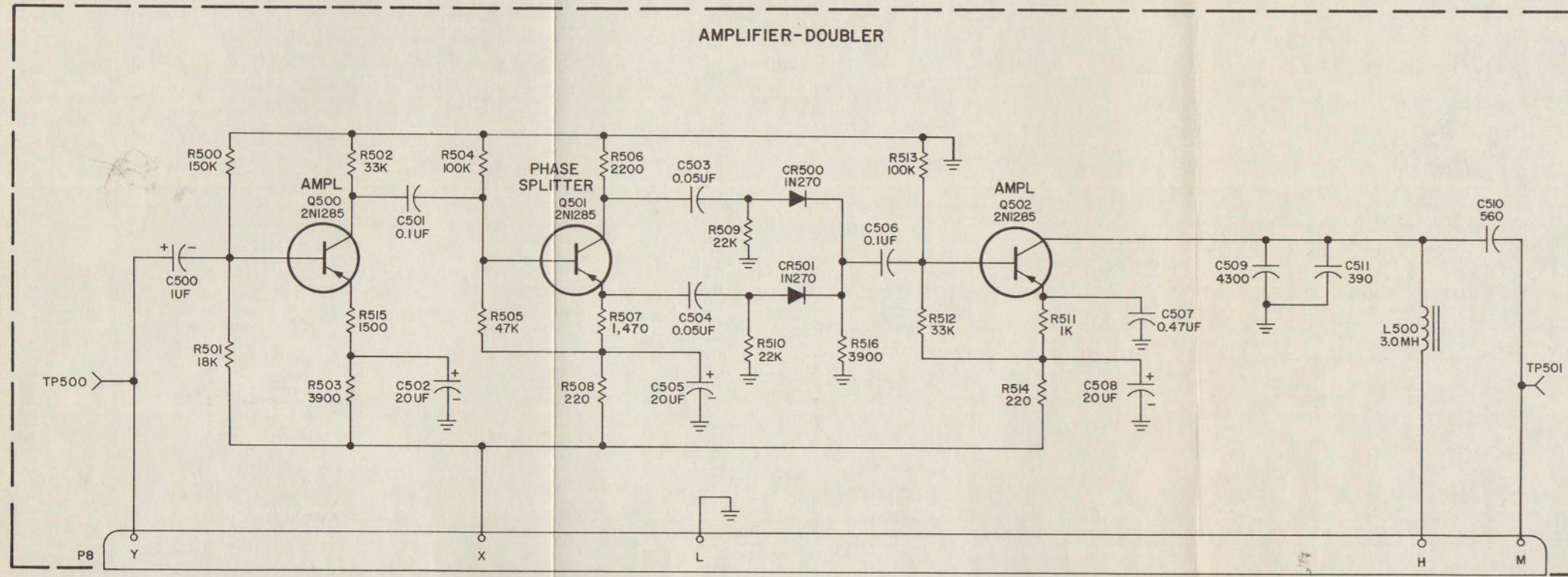

Figure 7-6. Average Voltmeter Card A6,
Schematic Diagram



NOTE:
1. UNLESS OTHERWISE INDICATED, ALL RESISTANCE VALUES ARE IN OHMS,
ALL CAPACITANCE VALUES ARE IN PICO FARADS, AND ALL INDUCTANCE
VALUES ARE IN MICROHENRYS.

Figure 7-7. 19-Kc Amplifier Card A7, Schematic Diagram



NOTE:
1. UNLESS OTHERWISE INDICATED, ALL RESISTANCE VALUES
ARE IN OHMS, ALL CAPACITANCE VALUES ARE IN PICOFARADS
AND ALL INDUCTANCE VALUES ARE IN MICROHENRYS.

Figure 7-8. Amplifier-Doubler Card A8,
Schematic Diagram

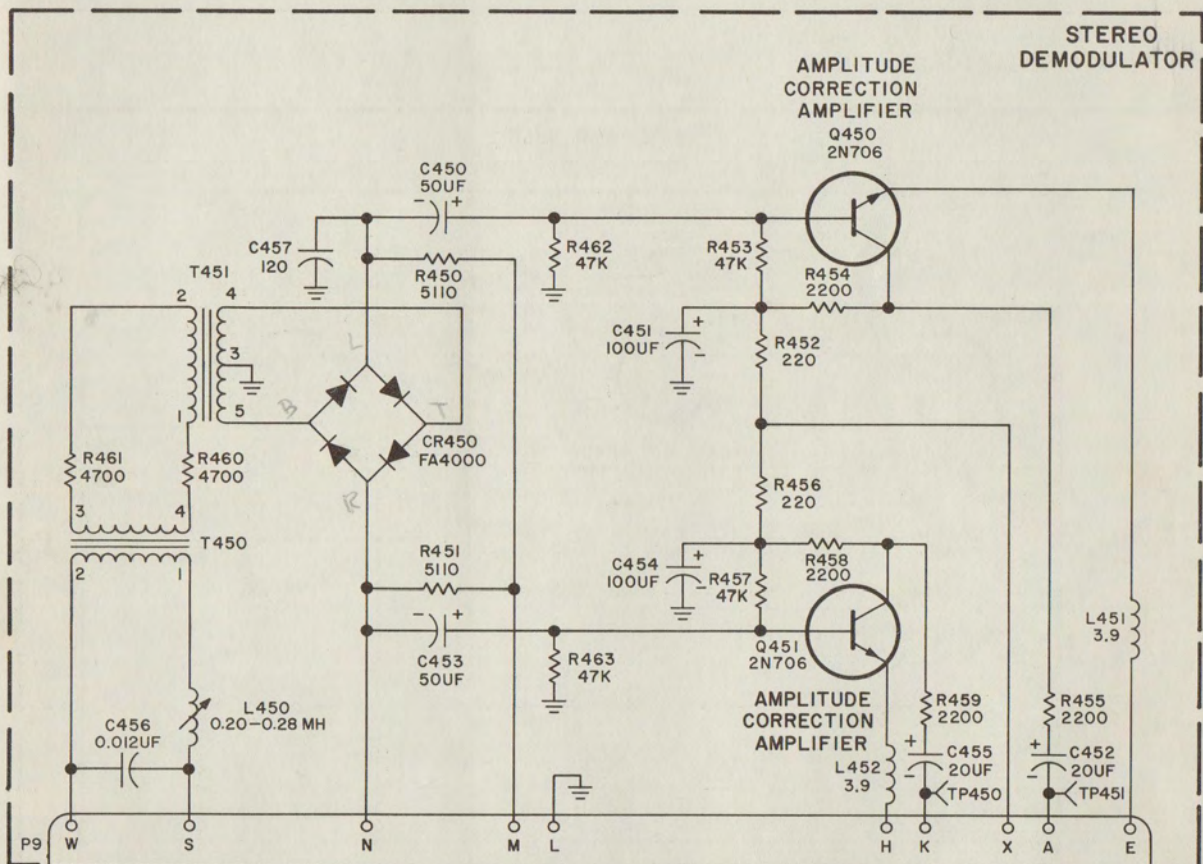

NOTE:

- I. UNLESS OTHERWISE INDICATED ALL RESISTANCE VALUES ARE IN OHMS, ALL CAPACITANCE VALUES ARE IN PICOFARADS, AND ALL INDUCTANCE VALUES ARE IN MICROHENRYS.

Figure 7-9. Stereo Demodulator Card A9, Schematic Diagram

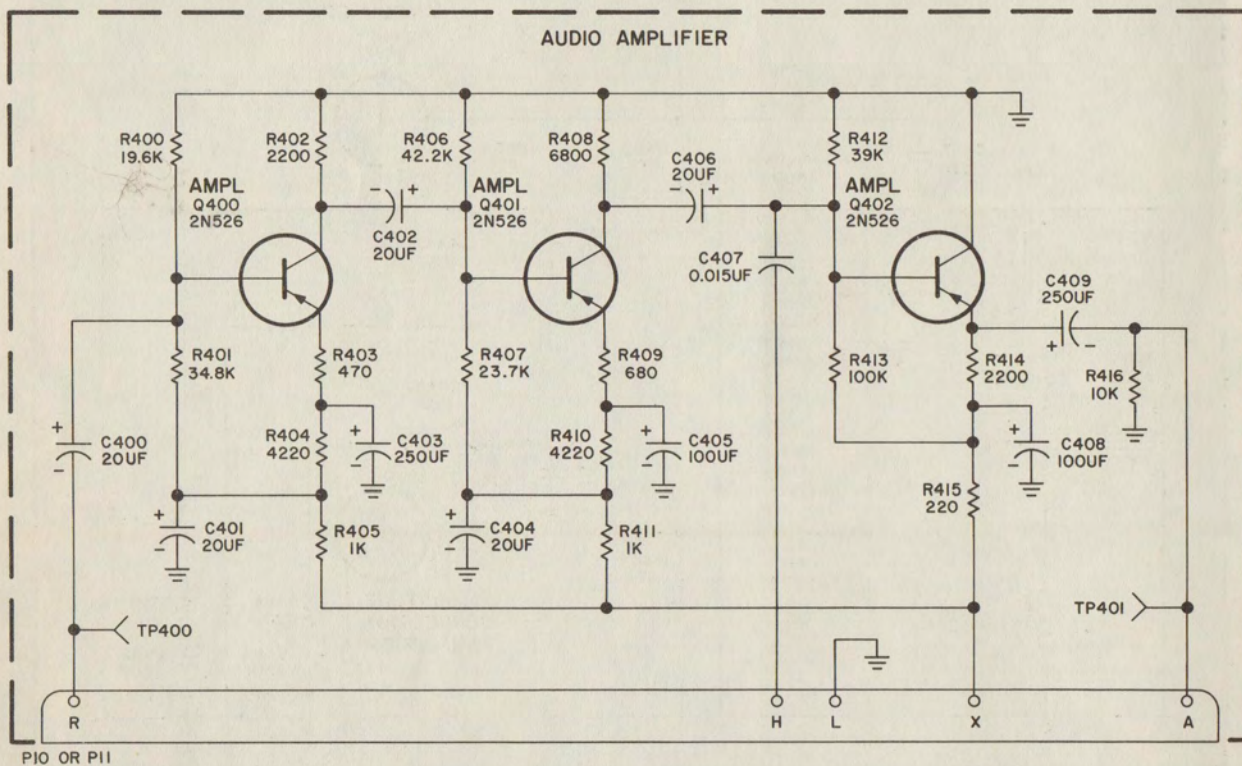

PIO OR PII

NOTE:
UNLESS OTHERWISE INDICATED ALL RESISTANCE VALUES ARE IN OHMS
AND ALL CAPACITANCE VALUES ARE IN PICOFARADS.

Figure 7-10. Audio Amplifier Cards A10, A11, Schematic Diagram

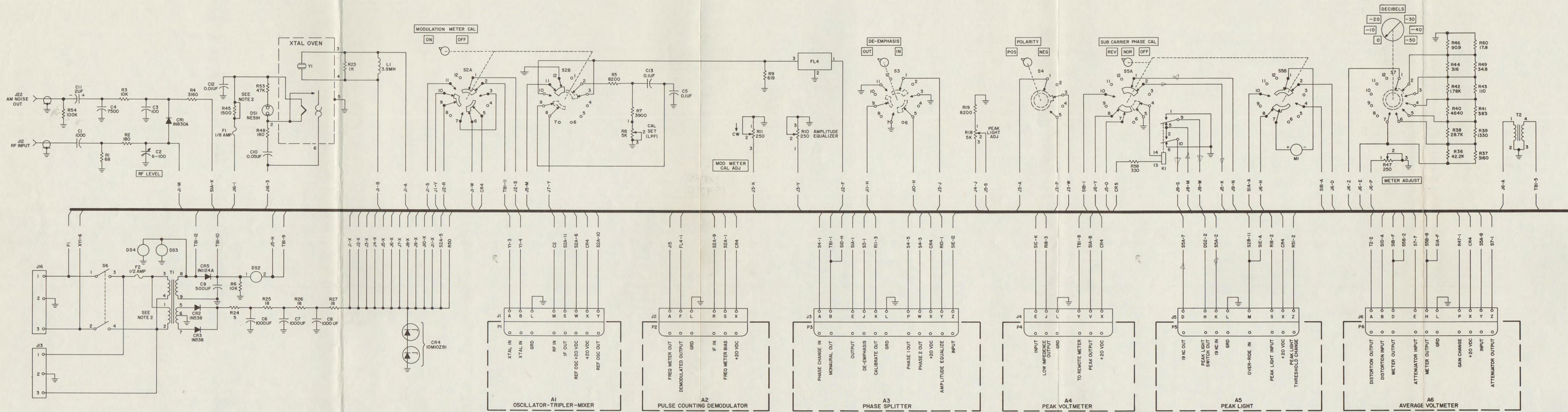
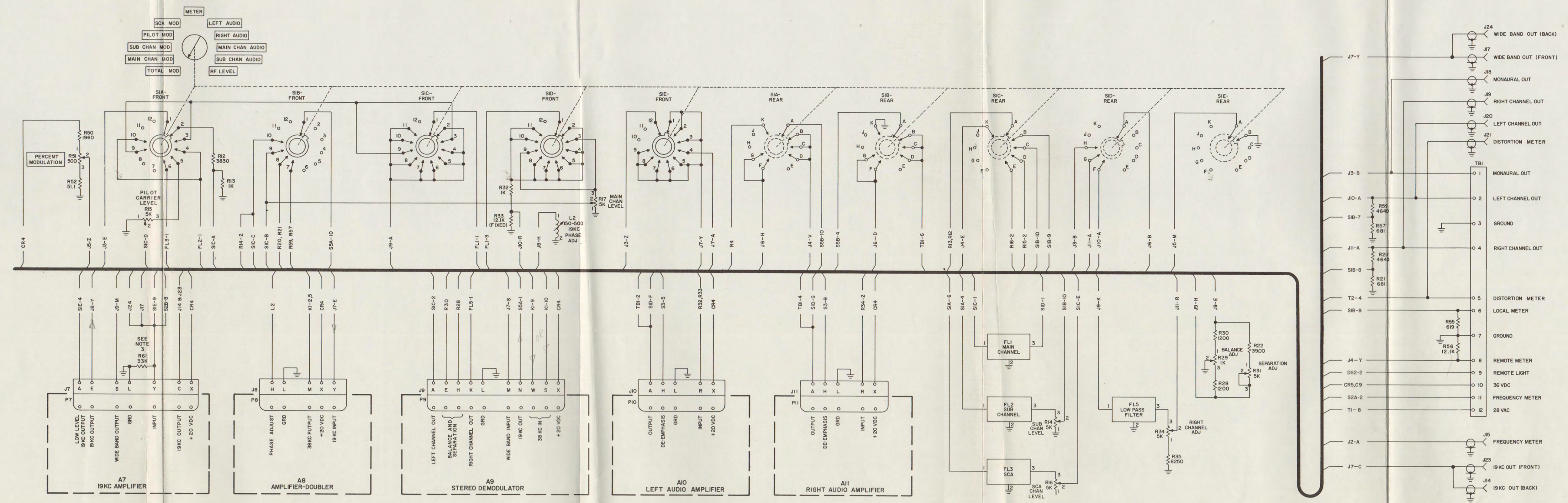

Figure 7-11. 900C-1() FM Modulation Monitor Chassis, Schematic Diagram (Sheet 1 of 2)

If You Didn't Get This From My Site,
Then It Was Stolen From...
www.SteamPoweredRadio.Com



If You Didn't Get This From My Site,
Then It Was Stolen From...
www.SteamPoweredRadio.Com

- NOTES:
1. UNLESS OTHERWISE INDICATED, ALL RESISTANCE VALUES ARE IN OHMS, ALL CAPACITANCE VALUES ARE IN PICO-FARADS, AND ALL INDUCTANCE VALUES ARE IN MICROHENRYS.
 2. FOR 220-VOLT OPERATION, REMOVE SHORT FROM R45 AND CONNECT PRIMARY WINDINGS OF T1 IN SERIES.
 3. RESISTOR R61 USED ONLY ON 900C-1B AND 900C-1C MODELS.

Figure 7-11. 900C-1() FM Modulation Monitor Chassis, Schematic Diagram (Sheet 2 of 2)

