

# COLLINS

**BROADCAST EQUIPMENT • 1962**

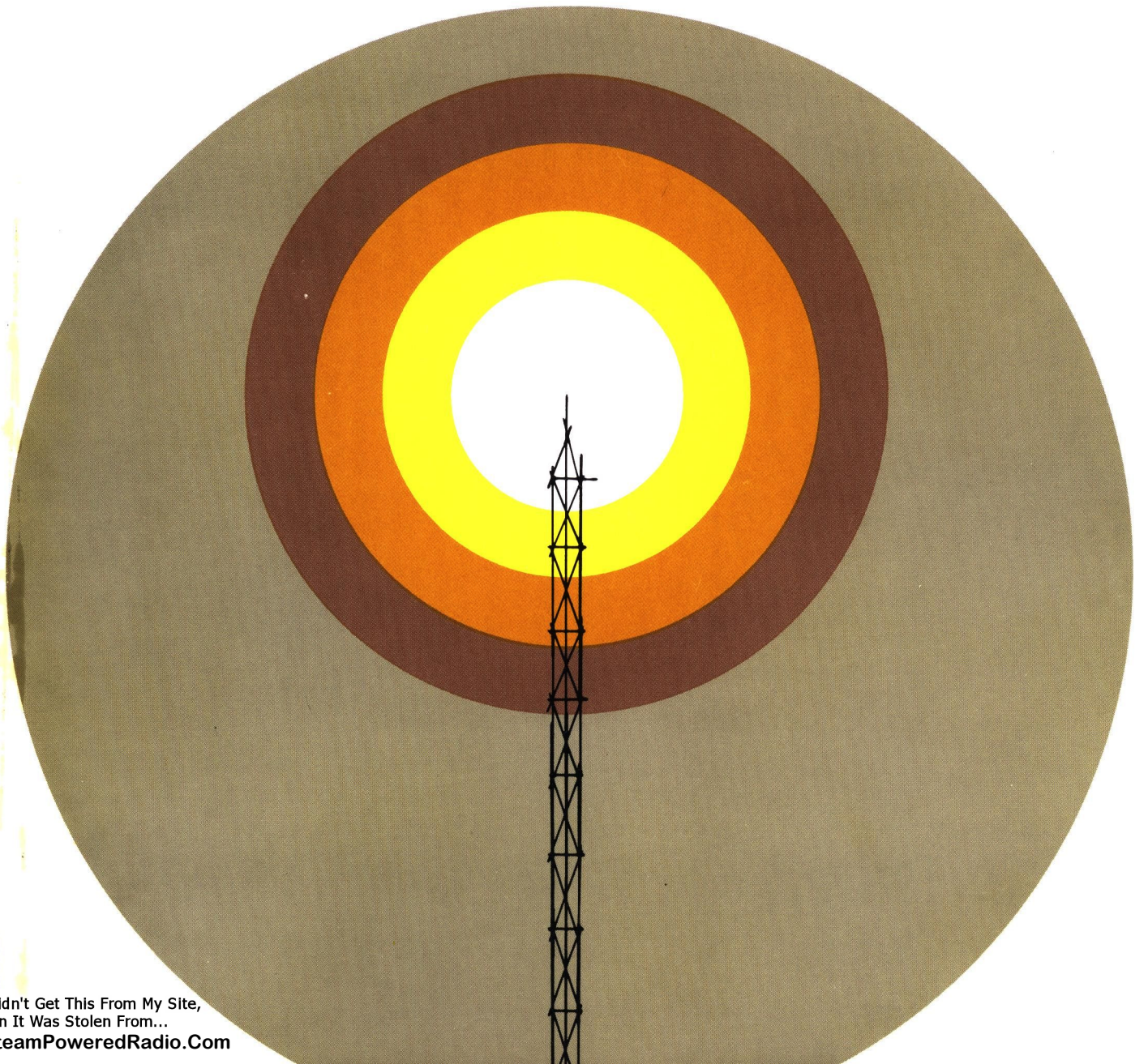



# SUGGESTED STATION LAYOUTS

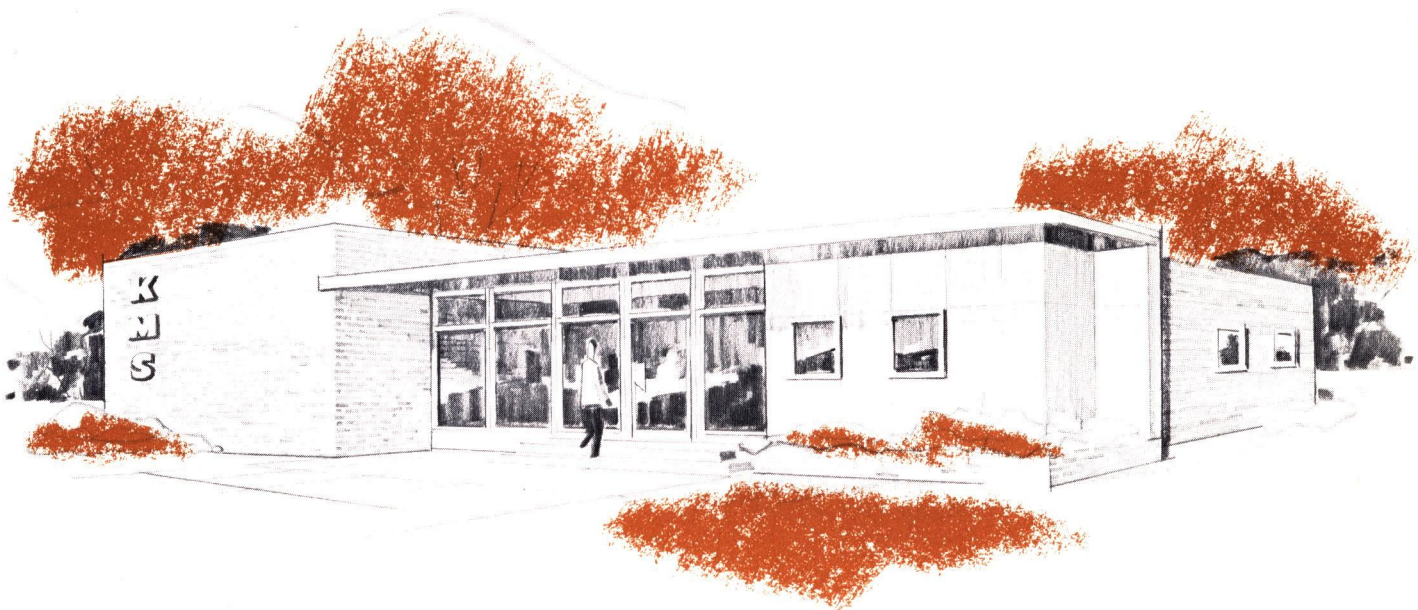
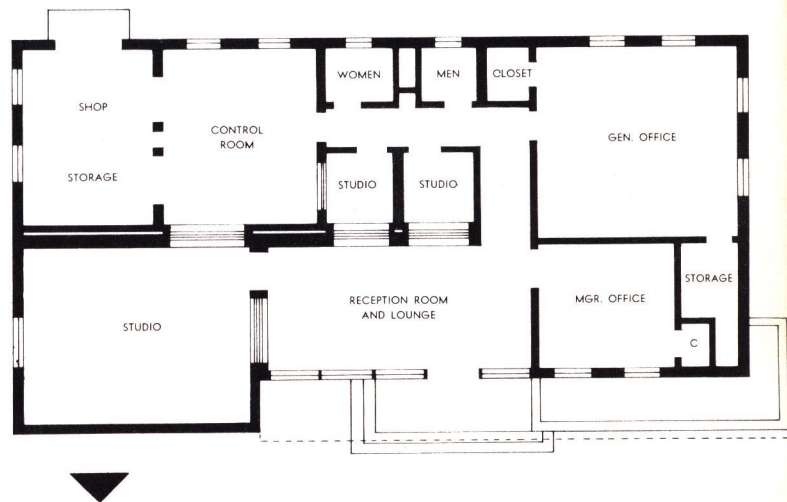
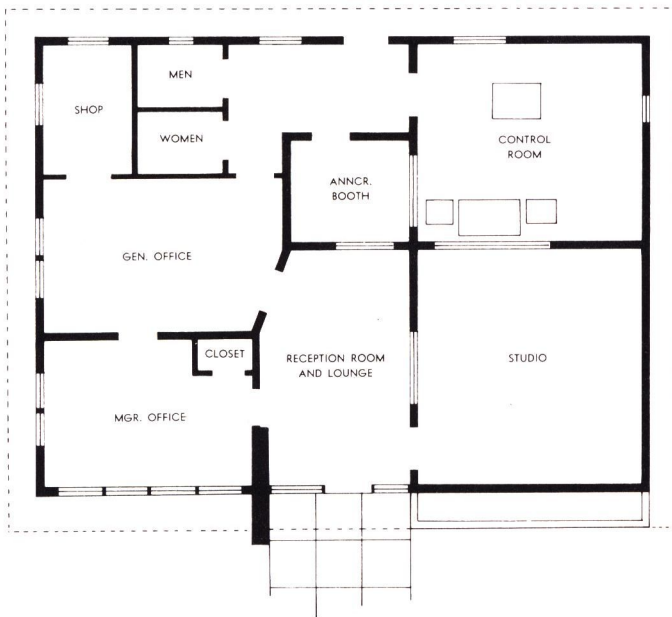



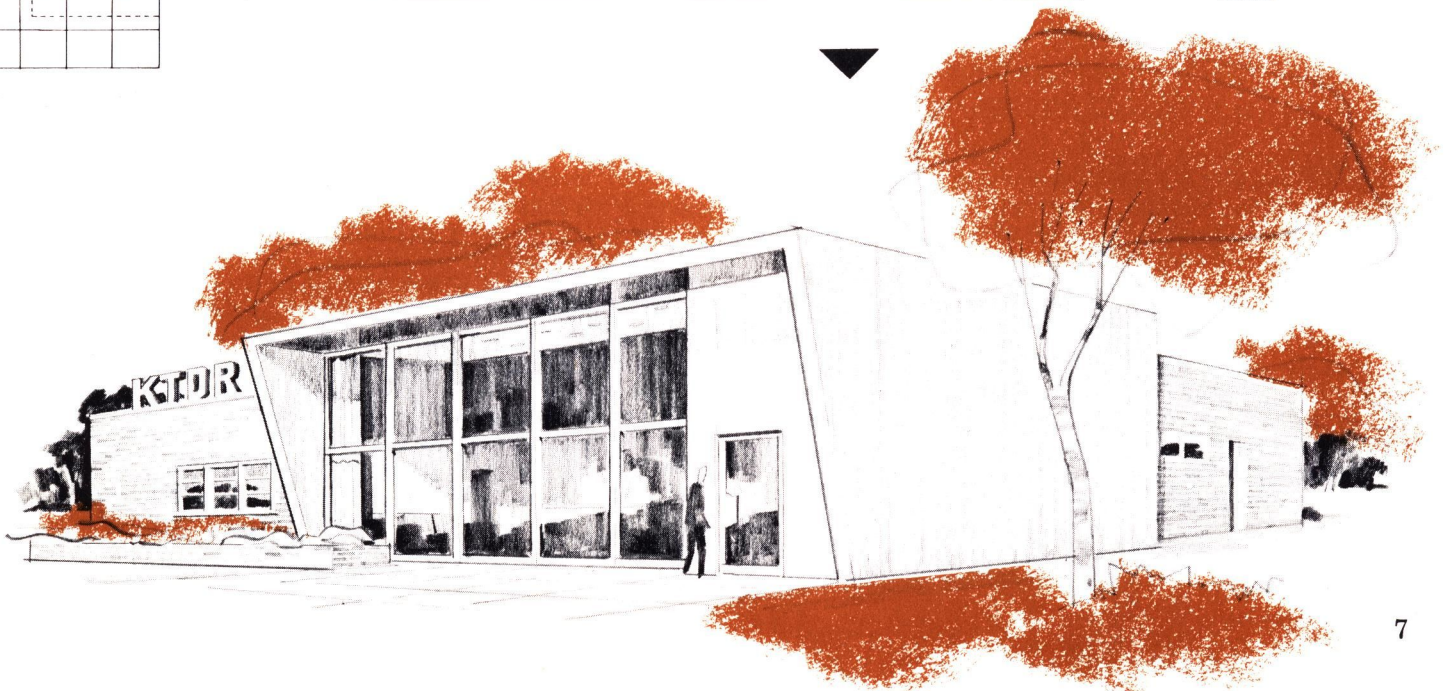
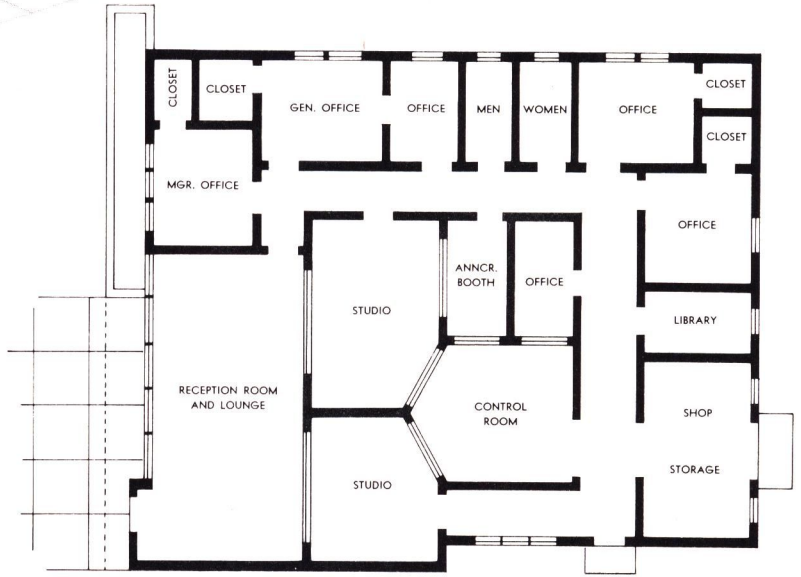
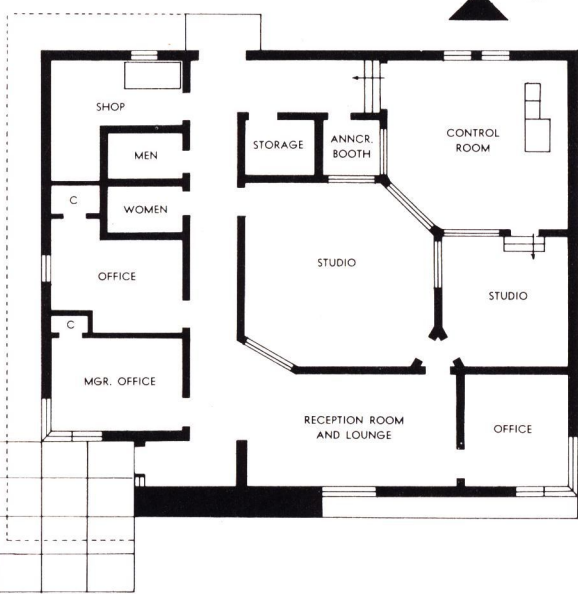
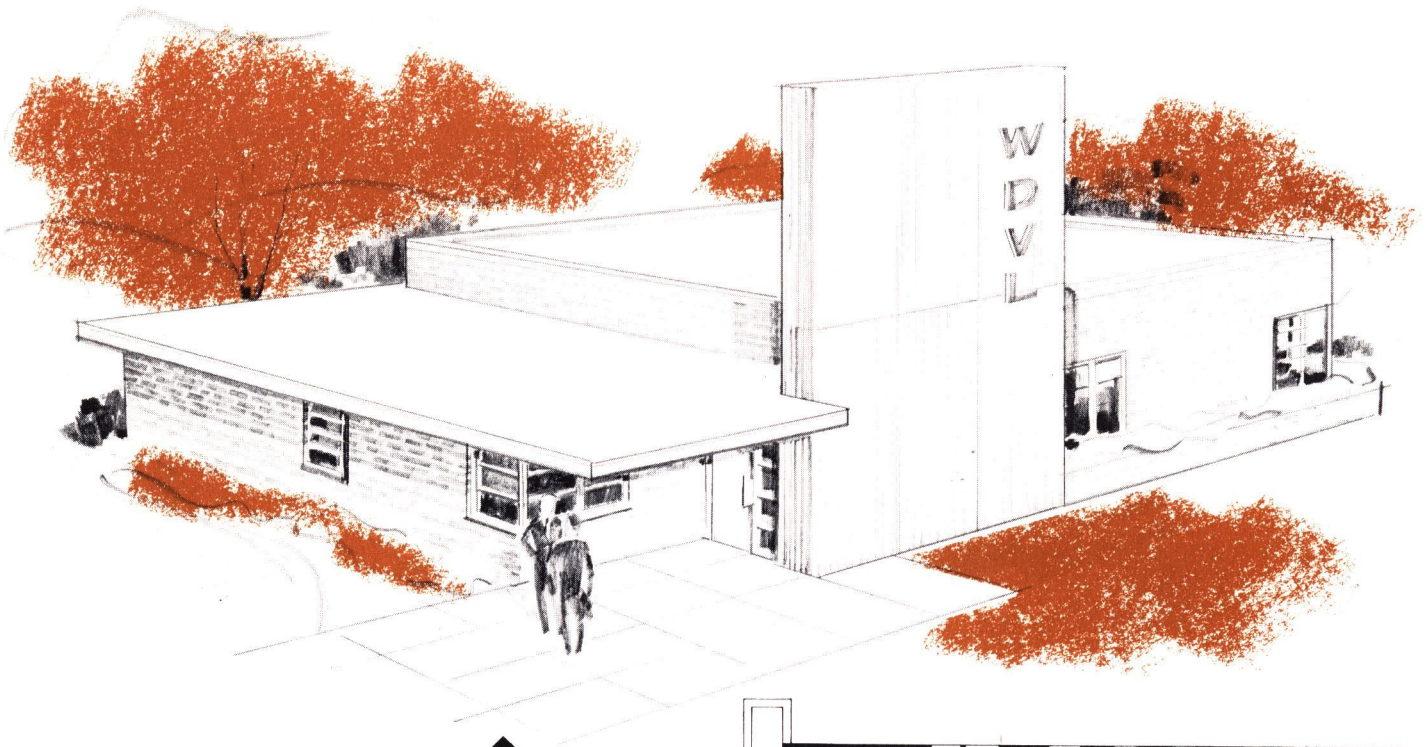



# AM TRANSMITTERS

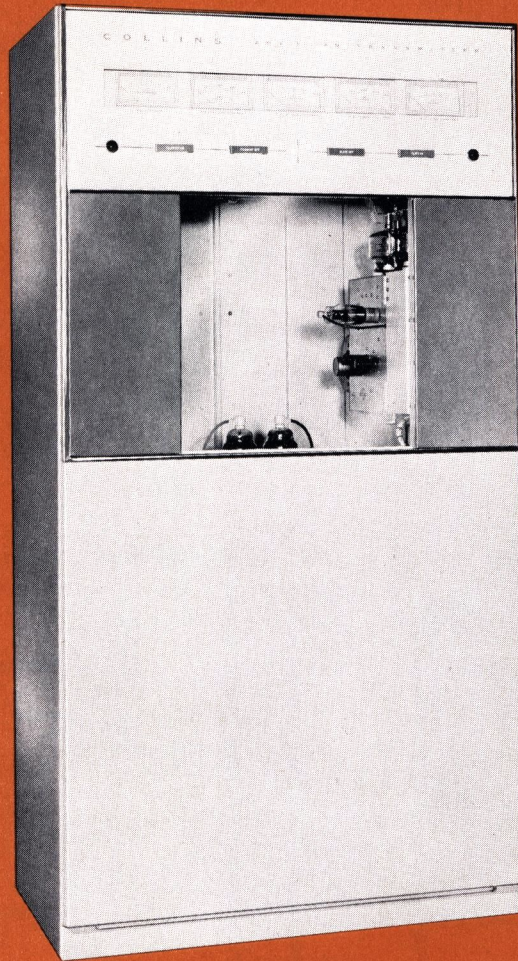

## COLLINS 20V-3 1,000/500/250-WATT AM TRANSMITTER

The Collins 20V-3 1,000/500/250-watt AM transmitter, designed for reliable, high fidelity broadcasting at any specified frequency from 540 to 1600 kc or in any of the high frequency broadcast bands up to 12 mc, has many features that make it one of the most advanced transmitters on the market.

The bold, clean-cut styling of the cabinet is in keeping with the modern design of the transmitter circuitry. Streamlined, brushed chrome trim and white meters add to the attractive appearance of the cabinet, which is finished in a high gloss gray, blue-gray and off-white baked enamel. The cabinet and circuitry provide unparalleled accessibility for operation, maintenance and inspection.

The RF and audio chassis swing out and the power supply tilts up so that all components are exposed.

Mounted on the RF and audio chassis are quiet, high capacity blowers which force air directly on the tubes to give an extra assurance of long tube life.

Pushbutton control of filament and plate power is provided and may be extended to a remote position. Automatic sequencing of the power control circuits is incorporated. The filament voltage control and power circuit controls may be adjusted while the transmitter is operating.

A typical stability of  $\pm 2$  cps is attained by using a highly perfected oscillator design in conjunction with very stable, low temperature coefficient crystals—a concept pioneered by Collins to eliminate the troublesome crystal oven.

Thermal time delay circuitry selects the optimum time interval before the transmitter can be returned to



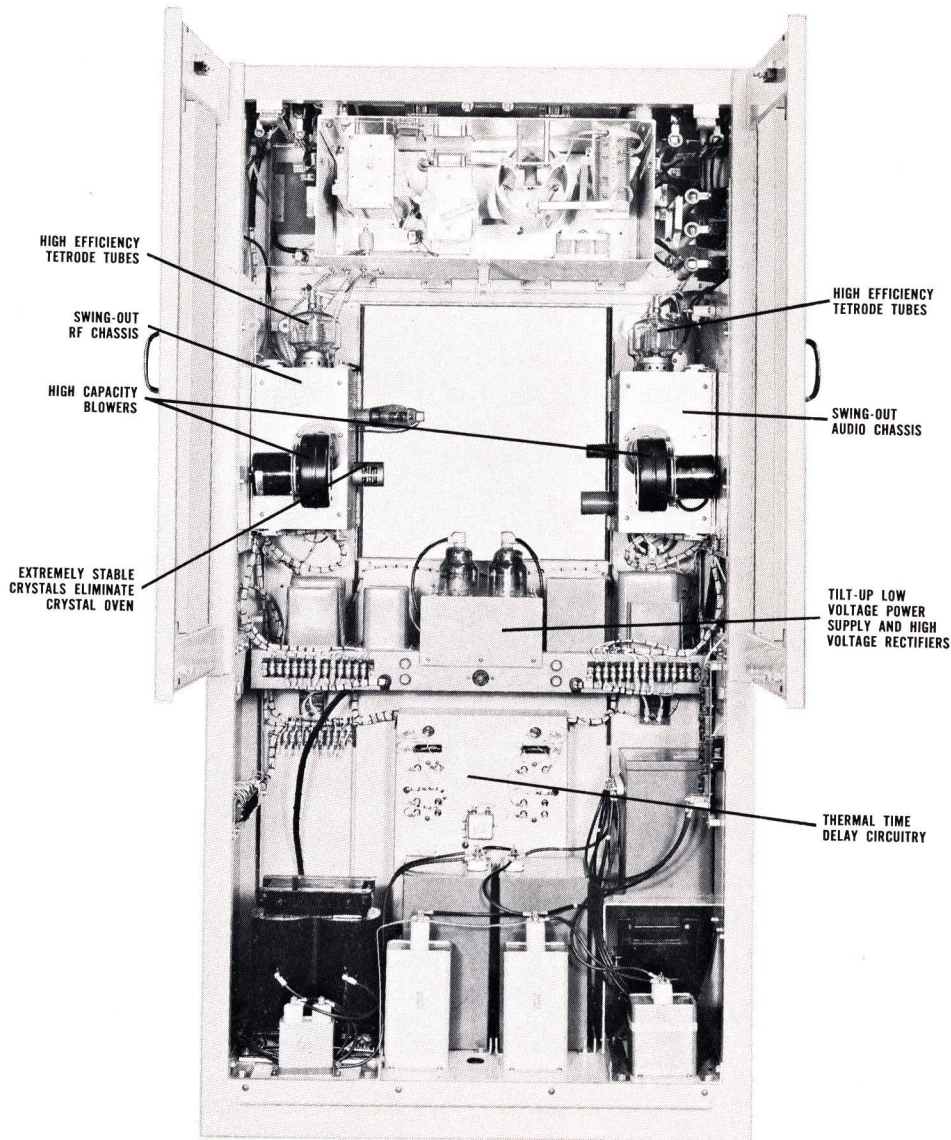

the air after a power line failure. After an instantaneous power interruption the carrier can be returned to the air immediately, cutting off-the-air time to a minimum. Overload relays are adjustable and are provided for the RF driver, audio driver, power amplifier and modulator stages. These relays are connected so that an overload removes plate power and the equipment must be re-energized manually.

The 20V-3 power supplies are heavy duty and conservative. One high voltage power supply is used for the modulator and final amplifier. A separate low voltage supply feeds the modulator screen grids, as well as the plates and screen grids of the other RF and audio tubes. The bias supply provides voltages for the modulator, power amplifier and other biasing throughout the transmitter.

The Collins 20V-3 uses four, Type 4-400A tetrodes in the modulator and final amplifier. The use of the 4-400A tetrodes is another concept pioneered by Collins and now widely accepted as the best in transmitter design.

*Frequency Range:* 540-1600 kc standard. Frequencies to 12 mc available.

*Power Output:* 1,000/500/250 watts.

*Frequency Stability:* Better than  $\pm 5$  cps. (Typical — Better than  $\pm 2$  cps.)

*Audio Frequency Response:* Within  $\pm 2$  db, 50-10,000 cps.

*Audio Frequency Distortion:* Less than 3%, 50-7,500 cps up to 95% modulation level. (Typical — Less than 3%, 30-15,000 cps.)

*Residual Noise Level:* 60 db or better below 100% modulation.

*Carrier Shift:* Less than 3%, 0-100% modulation. (Typical — Less than 2%.)

*RF Output Impedance:* 50-70 ohms unbalanced. Others, including balanced, available on order.



# AM TRANSMITTERS

BLOCK DIAGRAM 20V-3

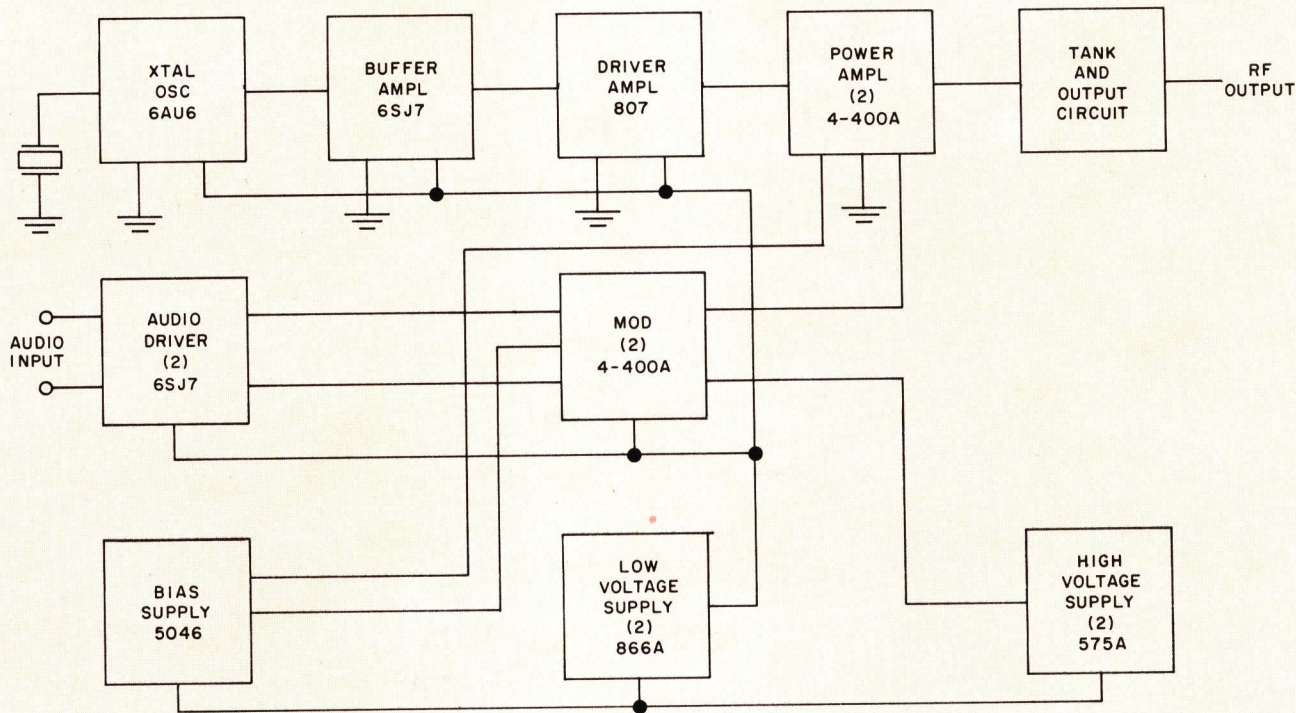

Audio Input Impedance: 150/600 ohms balanced.

Audio Input Level: +10 dbm,  $\pm 2$  db.

Power Source: 208-240 v ac, single phase 50/60 cps.

Power Demand (at 1,000 watts output):

Filaments	660 watts	85% pf
0% modulation	2,950 watts	80% pf
30% modulation	3,250 watts	83% pf
100% modulation	4,150 watts	83% pf

Tube Complement:

4	4-400A	2 — Final Amplifier
1	807	2 — Modulator Driver Amplifier
3	6SJ7	1 — Buffer Amplifier
1	6AU6	2 — Audio Amplifier
2	575A	Crystal Oscillator
2	866A	High Voltage Rectifier
1	5U4G	Low Voltage Rectifier
		Bias Rectifier

Ambient Temperature Range: +15°C to +45°C.

Size: 38" W, 76" H, 27" D.

Weight: Approx. 1,150 lbs.

Part No. 522 2480	Price on Request
Includes one set of tubes, one crystal and one instruction book.	
No Part Number	\$259.00
Complete set of spare tubes.	
No Part Number	\$133.00
FCC set of spare tubes.	
Part No. 545 3041 00	\$50.00
250-watt power reduction kit for existing 20V-2 transmitters.	
No Part Number	\$500.00
Conelrad frequency change for 20V, 300J and 550A transmitters, factory modification less Conelrad crystal.	
No Part Number	\$300.00
Factory short wave conversion, 1.6 mc-12 mc.	
No Part Number	\$90.00
Spare crystal for 20V, 300J and 550A transmitters.	

## COLLINS 550A-2 500-WATT AM TRANSMITTER

Identical in appearance and in nearly all specifications to the Collins 20V-3 1,000-watt AM Transmitter, the 550A-2 is a more economical unit built on special order to provide 500-watt transmission. Although the 550A-2 may be modified to a higher power at a later date, the 20V-3 is recommended for 1,000 watts.

The modulator and power amplifier use two each of tube type 4-250A. The audio input pad is changed due to the different modulator requirements, and overload circuits are changed to compensate for lower power output. The modulation transformer, modulation reactor and plate transformer are smaller units, and the plate current meter and antenna current meter are changed to accommodate the lower voltages and currents. Circuits for remote metering of plate voltage and plate current are built in.

Power Demand (at 500 watts output):

Filaments	660 watts	85% pf
0% modulation	2,450 watts	80% pf
30% modulation	2,700 watts	83% pf
100% modulation	3,200 watts	83% pf

Power Output: 500/250 watts nominal; 550/275 watts actual into a 50-70 ohm resistive load.

Part No. 522 2557	Price on Request
Includes one set of tubes, one crystal and one instruction book.	
No Part Number	\$243.00
Complete set of spare tubes for 550A-2.	
No Part Number	\$125.00
FCC set of spare tubes.	
No Part Number	\$500.00
Conelrad frequency change for 300J, 550A and 20V transmitters, factory modification less Conelrad crystal.	
No Part Number	\$300.00
Factory short wave conversion, 1.6 mc-12 mc.	
No Part Number	\$90.00
Spare crystal for 550A, 300J and 20V transmitters.	



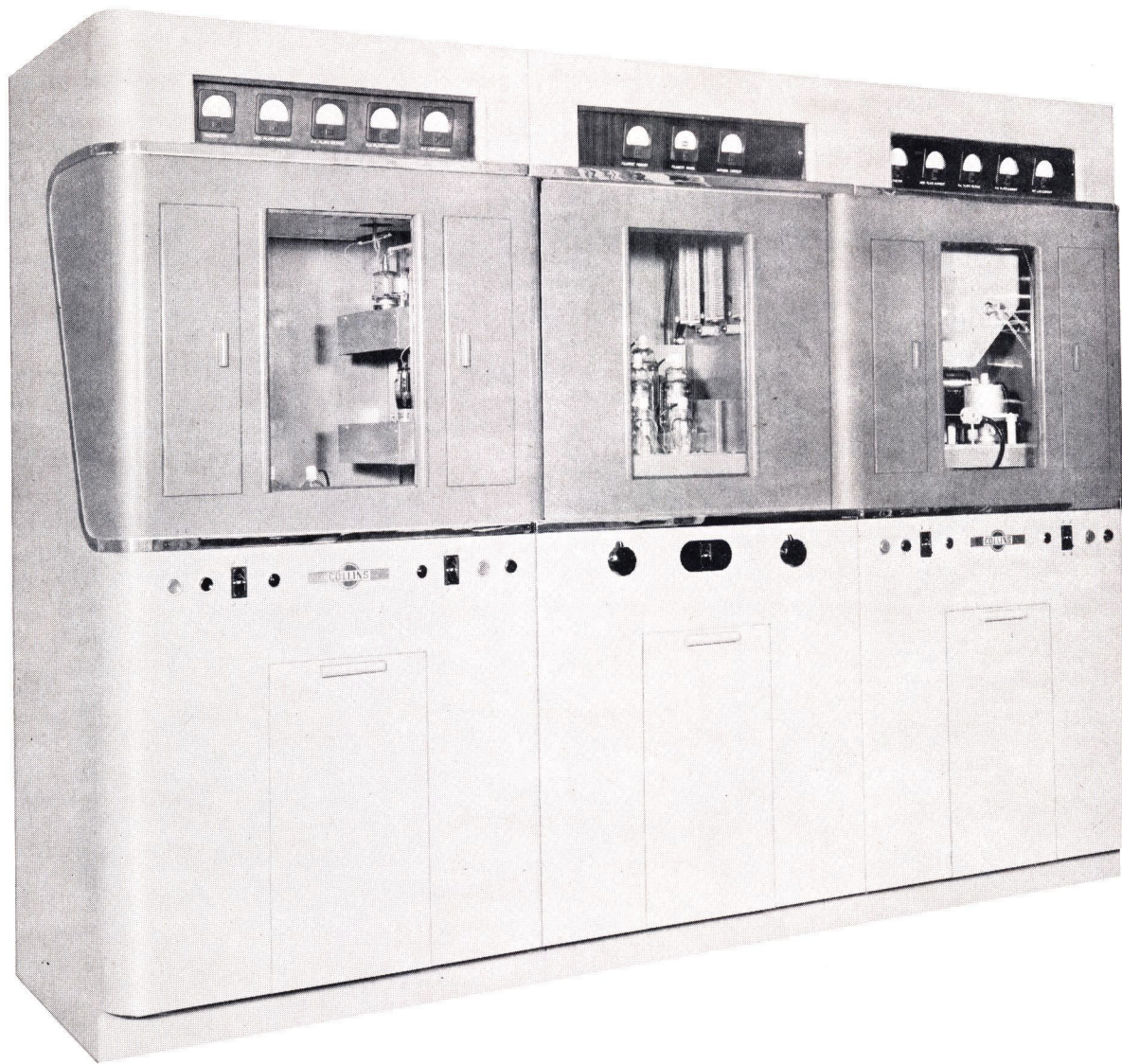

## **COLLINS 21E/M 5/10 KW AM TRANSMITTER**

The 5,000-watt 21E and 10,000-watt 21M transmitters permit operation at any frequency from 540 kilocycles to 10 megacycles. A convenient power increase package converts the 5 kw 21E into a 10 kw 21M overnight.

Straightforward styling of the transmitter cabinets is in keeping with the modern design of the transmitter circuitry. The cabinets are finished in high gloss, blue-gray baked enamel with polished chrome trim. Easy access to relays and contactors for inspection and adjustment is possible while the transmitter is on the air.

Pushbutton control of filament and plate power is provided. Automatic sequencing is supplied so that all filament bias and plate voltages are applied in correct sequence and with proper time delays. If desired, the pushbutton and indicating light circuits may be extended to a remote position.

A thermal time delay circuit is employed which gives the transmitter the ability to select the optimum

time interval before it can be returned to the air after a power interruption. When a short power interruption occurs, the delay circuit allows only enough time for the filaments to reach operating temperature before the transmitter can be returned to the air. An arc-suppression circuit protects the final amplifier and RF driver tank circuits against arcs to ground due to lightning or other causes. Should an arc occur, this circuit removes plate power until the arc is extinguished and then returns the equipment to normal operation. Class AB<sub>1</sub> high level modulation is used to eliminate the audio driver transformer and its attendant problems. Adjustable overload relays are furnished for the RF driver, audio driver, power amplifier and modulator stages. Power supplies are heavy duty and conservative.

Plate voltage for the modulator and final amplifier is furnished by a common high voltage supply using six Type 575A rectifiers in a full-wave, 3-phase circuit. Bias for the modulator and final amplifier is provided by a common low voltage supply using two Type 866A rectifiers in a full-wave, 1-phase circuit. The driver



# AM TRANSMITTERS

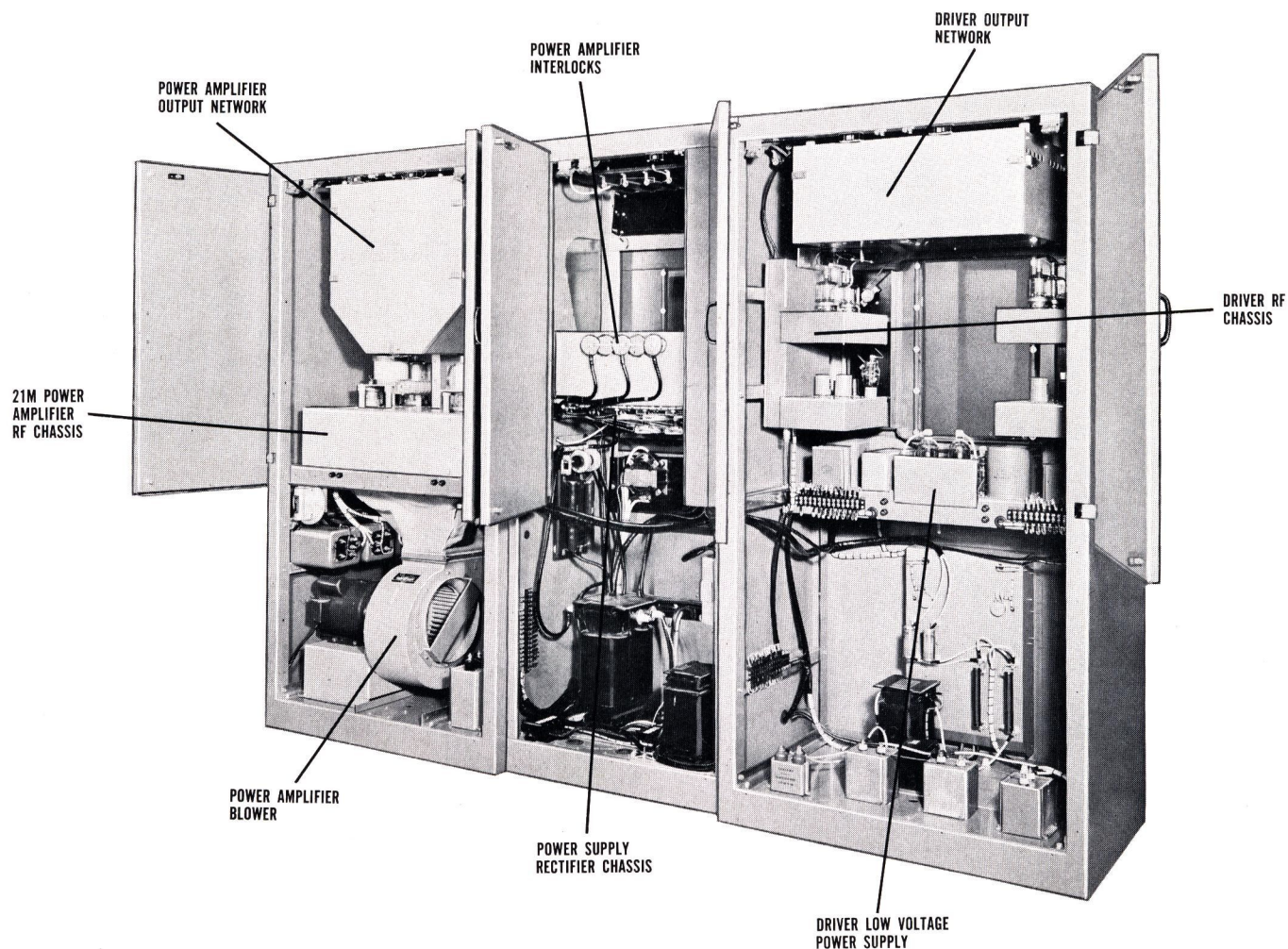

unit has separate power supplies for high voltage, low voltage and bias.

The driver high voltage supply employs two Type 872A mercury vapor rectifiers in a single-phase, full-wave circuit. It supplies dc voltage for the plates of the audio drivers and the plates and screens of the RF driver tubes. The low voltage supply uses two Type 866A mercury vapor rectifiers in a single-phase, full-wave circuit to provide dc voltage for plates and screens of the low power stages and for screens of the audio driver tubes. The bias supply employs a 5U4G high vacuum rectifier in a single-phase, full-wave circuit. It supplies bias to the 807 amplifier, audio driver, and RF driver amplifier tubes, and dc voltage for the arc-suppression circuit. The entire RF network is double shielded to reduce spurious radiation. RF circuits are completely independent of the cabinet proper.

A highly perfected oscillator design in conjunction with extremely stable, low temperature coefficient crystals has resulted in a frequency stability of better than  $\pm 5$  cps (typical performance is better than  $\pm 2$  cps) and has eliminated the troublesome crystal oven and its associated thermostats, relays and other controls.

*Frequency Range:* 540-1600 kc standard, frequencies to 10 mc available.

*Power Output:* 21E — 5,500/1,100 watts; 5,500/550 watts on order.

21M — 10,600/5,500 watts; 10,600/1,110 watts on order.

*Power Increase Package:* Converts 21E to a 21M.

*Frequency Stability:* Better than  $\pm 5$  cps. (Typical — Better than  $\pm 2$  cps.)

*Audio Frequency Response:* Within  $\pm 2$  db from 30-10,000 cps. (Typical — Within  $\pm 1.5$  db from 30-15,000 cps.)

*Distortion:* Less than 3% from 50-10,000 cps for 95% modulation, including all harmonics up to 16 kc. (Typical — Less than 3% from 30-15,000 cps.)

*Residual Noise Level:* 60 db or better below 100% modulation.

*Carrier Shift:* Less than 3%. (Typical value less than 2%.)



RF Output Impedance: 50 ohms unbalanced, 40-600 ohms unbalanced on order.

Audio Input Impedance: 150/600 ohms balanced.

Audio Input Level: +10 dbm, ±2 db, 600 ohm input with built-in input pad. With the input pad removed, -5 dbm is sufficient for 100% modulation. 150 ohm connection of input transformer is possible when desired.

Power Source: 208/230 v, 50/60 cps, 3 phase; 50 cps on special order.

Power Demand:

	Power (kw)	Power Factor (%)
*5,000 watts		
Filaments and Blowers	2.64	—
Output — 0% Modulation	12.8	90.0
— 30% Modulation	13.8	90.0
— 100% Modulation	18.5	90.0
*10,000 watts		
Filaments and Blowers	3.28	—
Output — 0% Modulation	21.2	90.5
— 30% Modulation	23.6	90.1
— 100% Modulation	32.8	91.5

Tube Complement:

21E		21M	
1 6AU6	Crystal Oscillator	1 6AU6	
1 6SJ7	Buffer or Multiplier	1 6SJ7	
1 807	Amplifier	1 807	
2 4-125A	Driver	2 4-125A	
1 3X2500A3	Final Amplifier	2 3X2500A3	
2 6SJ7	Audio Amplifier	2 6SJ7	

2 4-125A	Driver Amplifier	2 4-125A
2 3X3000A1	Modulator	2 3X3000A1
1 5U4G	Exciter Bias	1 5U4G
2 866A	Final Amplifier Bias	2 866A
2 866A	Low Voltage Plate	2 866A
2 872A	Intermediate Plate	2 872A
6 575A	High Voltage Plate	6 575A

Ambient Temperature Range: Up to 45°C.

Size: 105¼" W, 76" H, 28" D. (Plate transformer external.) Occupies 21 square feet of floor space.

Weight: 21E — Approx. 2,700 lbs.

21M — Approx. 3,000 lbs.

\*21E capable of 5,500 watts output; 21M capable of 10,600 watts output.

<b>Part No. 505 9578</b>	<b>(Type 21E)</b>	<b>Price on Request</b>
Includes one set of tubes, one crystal and one instruction book.		
<b>No Part Number</b>		<b>\$904.00</b>
Complete set of spare tubes for 21E.		
<b>No Part Number</b>		<b>\$555.00</b>
FCC set of spare tubes for 21E.		
<b>No Part Number</b>		<b>\$500.00</b>
5,000/500-watt 21E transmitter on special order. Price in addition to basic 5,000/1,000-watt unit.		
<b>Part No. 505 9580</b>	<b>(Type 21M)</b>	<b>Price on Request</b>
Includes one set of tubes, one crystal and one instruction book.		
<b>No Part Number</b>		<b>\$1,106.00</b>
Complete set of spare tubes for 21M.		
<b>No Part Number</b>		<b>\$555.00</b>
FCC set of spare tubes for 21M.		
<b>No Part Number</b>		<b>Price on Request</b>
10,000/1,000-watt 21M transmitter on special order. Price in addition to basic 10,000/5,000-watt unit.		
<b>No Part Number</b>		<b>\$1,000.00</b>
Conehrad frequency change for 21E/M transmitters, factory modification less Conehrad crystal.		
<b>No Part Number</b>		<b>\$1,000.00</b>
Factory short wave conversion, 1.6 mc-10 mc.		
<b>No Part Number</b>		<b>\$90.00</b>
Spare crystal for 21E/M.		

BLOCK DIAGRAM 21E/M

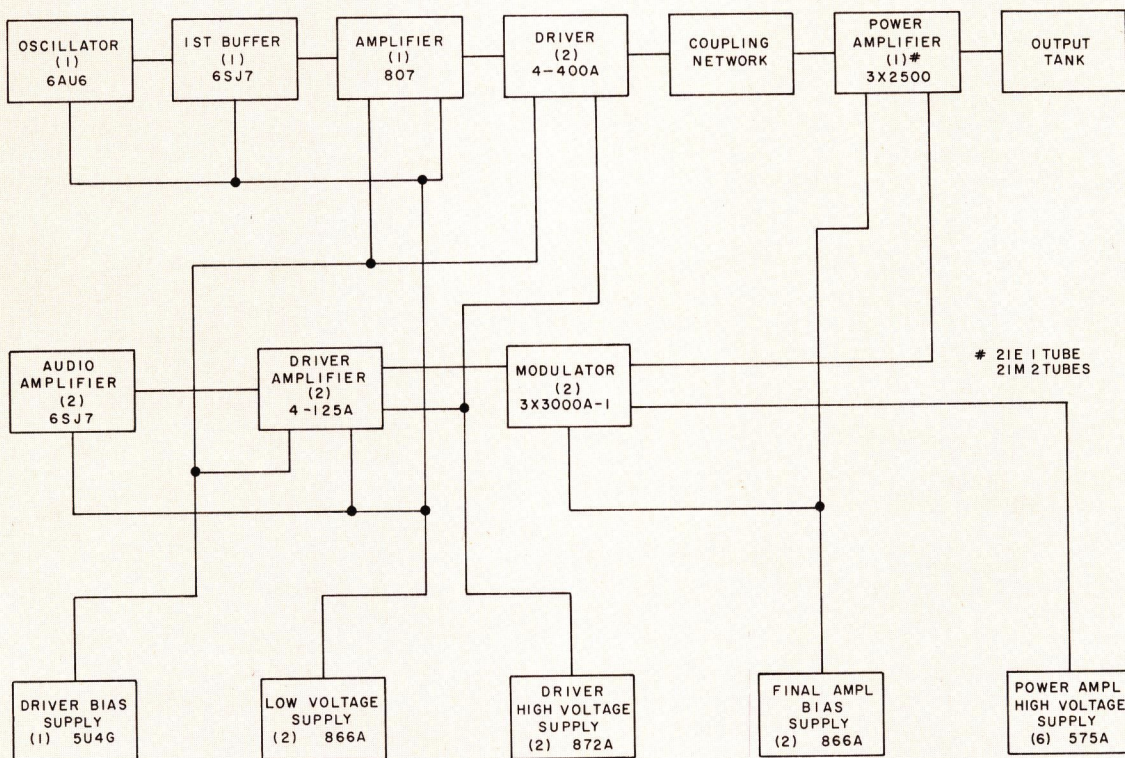



## AM TRANSMITTERS

### COLLINS AM TRANSMITTER CONVERSION KITS

The conversion kits listed below for the various Collins AM Transmitters include all transformers, meters and necessary capacitors for the same frequency. Crystals are not included. One set of tubes is included for the final RF and audio stages only and any necessary rectifiers. Components for frequency change are additional.

No Part Number 300J-2 to 550A.	\$1,100.00
No Part Number 550A to 20V-2.	\$1,395.00
No Part Number 330J-2 to 20V-2.	\$1,525.00
No Part Number 21E to 21M.	\$2,995.00

### COLLINS 172G DUMMY LOAD

This air-cooled unit provides a load to dissipate transmitter output for off-the-air testing. Consisting of 8 ferrule type, non-inductive resistors, with insulated end brackets and clips, it may be mounted on the transmitter or adjacent wall. The 172G-1 has an impedance of 52 ohms; the 172G-2, 73 ohms. *Power Rating:* 1 kw. *Size:* Approx. 6" W, 9" H, 12½" D. *Weight:* 5 lbs.

Part No. 522 1410 014	(Type 172G-1)	\$62.50
Part No. 522 1411 014	(Type 172G-2)	\$62.50

### STATES WG-52 DUMMY LOAD

An air-cooled dummy load to dissipate output of the Collins 21E AM Transmitter. The WG-52 has an impedance of 52 ohms and a peak of 7.5 kw.

Part No. 097 8138 00	\$250.00
----------------------	----------

### COLLINS 42E ANTENNA COUPLING UNITS

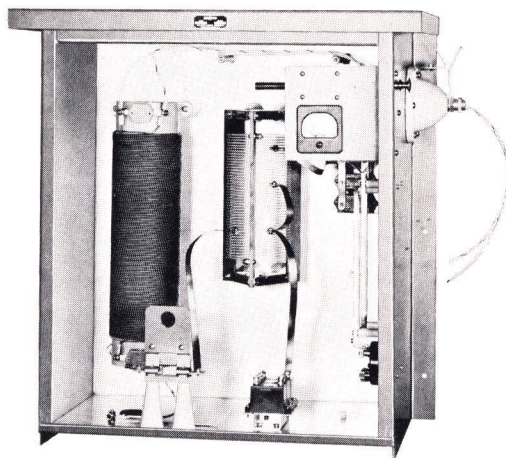

These specially constructed units match a series-fed vertical radiator to an unbalanced transmission line. Intended for continuous, unattended duty in conjunction with transmitters having emission type A0, A1, A2 or A3, the 42E-7 operates with transmitters of

carrier power output of 250-1,000 watts. The 42E-8A operates with transmitters of 5,000 watts and the 42E-8B operates with transmitters of 10,000 watts.

The electrical circuit of the 42E Antenna Coupling Units is a low-pass "T" network with good harmonic attenuating properties. A three-wire or two-wire tower lighting filter choke and remote antenna current sampling transformer may be mounted in the cabinet, and an antenna current meter and line current meter jack are provided.

A horn gap furnishes lightning protection. The antenna connection is made by an insulated feed-through bushing on the side of the cabinet and the bushing has a hollow stud for the lighting circuit. The transmission line comes through the base of the cabinet. Gray weatherproof aluminum housing. Remote antenna current metering kit and antenna current transformer for remote reading of antenna current up to 25 amps available for all Collins AM Transmitters.

*Size:* 42E-7 — 29" W, 28" H, 18" D. *Weight:* 64 lbs. *Size:* 42E-8A/B — 36" W, 28" H, 22" D. *Weight:* 124 lbs.

Part No. 522 1028	(Type 42E-7)	\$350.00
Part No. 522 1029	(Type 42E-8A)	\$595.00
Part No. 522 1029	(Type 42E-8B)	\$875.00

### COLLINS TOWER LIGHTING FILTER CHOKES



These solenoid wound 2- and 3-wire chokes provide high impedance throughout the broadcast band for isolation of the ac power lines from the antenna. Coils are wound of #10 wire and are rated at 2,000 watts, 120 v ac, single phase. Provided with mounting brackets and standoff insulators for mounting in 42E-7/8 antenna coupling units. Weatherproof cabinets are available for outdoor mounting.

Part No. 543 3927	Unhoused, 2-wire, 2,000 watts.	\$72.50
Part No. 543 3926	Unhoused, 3-wire, 2,000 watts.	\$105.00

### COLLINS REMOTE ANTENNA METERING KIT

The Collins remote antenna current metering kit is designed for the Collins series of AM transmitters. The kit for the 550A-2 and 20V-3 includes RF transformer, thermocouple, remote meter and meter mounting bracket. Specify type of tuner, base current of



tower, base resistance or complete description of antenna system.

The kit for the 21E and 21M transmitters includes RF transformer and thermocouple. (Remote meter is included in transmitter.) Specify type of tuner, base current of tower, base resistance or complete description of antenna system.

- No Part Number \$75.00  
For 20V-3 and 550A-2 Transmitters.
- No Part Number \$95.00  
For 20V-3 and 550A-2 Transmitters. Same as above but with expanded scale and matching thermocouple.
- No Part Number \$50.00  
For 21E/M Transmitters.

## COLLINS ANTENNA CURRENT TRANSFORMER

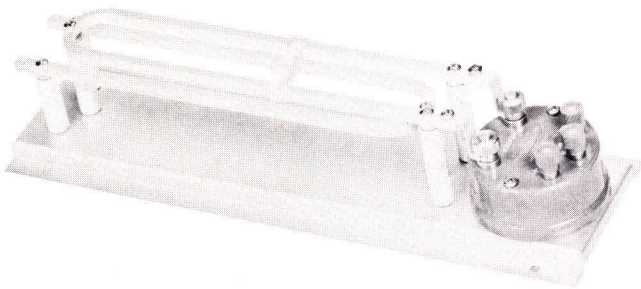

Used with remote thermocouple and meter for remote monitoring of antenna current. For currents up to 25 amps.

Part No. 543 3917 \$25.00

## RUST REMOTE CONTROL SYSTEMS

Rust Remote Control Systems consist of self-contained transmitter and control units, equipment for obtaining frequency and modulation monitor readings and accessory units coordinated on "building block" principles.

These are tubeless dc systems that can control normal transmitter requirements such as switching program lines, adjusting plate or filament voltage, operating a line variac, CONELRAD switching, operation of power contactors, metering of voltages and currents, loading and tuning, turning transmitter on or off and illuminating and metering of tower lights. All Collins transmitters can be equipped with Rust Remote Control equipment at the factory or in the field.

**RUST SERIES C** — Provides maximum control for one transmitter station where a high order of flexibility is desired. Used with a standard complement of accessory units to provide up to nine meter readings and ten two-direction control functions. The system is designed on proven dial telephone principles and the entire unit operates without vacuum tubes, amplifiers, oscillators or tuned circuits. The unit allows full accessibility with drop-down front panels, and it also has provision for checking metering circuit calibration at the control point.

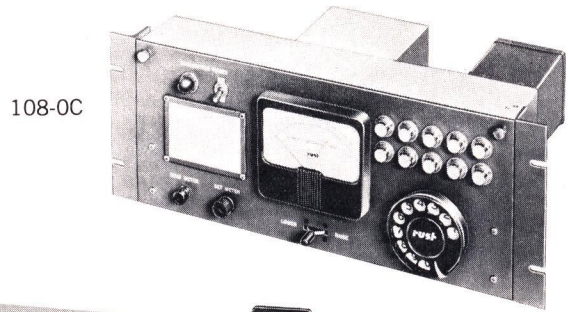

108-0C

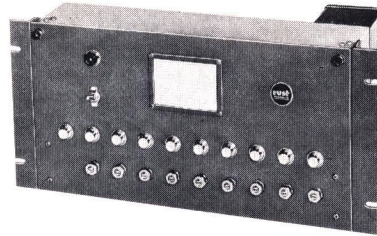

108-1C

*Power (each unit):* 100-130 v, 50-60 cps, 25 va or less. *Function Indication:* By individual numbered pilot light indicators. *Telephone Line:* Two inexpensive signal circuit lines required; maximum dc loop resistance, 4,000 ohms. *Size:* 108-0C Control Unit — 19" W, 7" H, 7½" D. 108-1C Transmitter Unit — 19" W, 8¾" H, 7½" D.

Part No. 097 1976 00 (Type 108-0C) \$500.00  
Part No. 097 1977 00 (Type 108-1C) \$695.00

**RUST SERIES D** — Designed for those stations needing the utmost in system capacity, flexibility and reliability, the D Series provides up to 24 meter readings and 25 two-direction control functions. Recommended for larger stations with more than one transmitter or other situations requiring a large capacity system. Operates on dial telephone principles and operates without vacuum tubes, amplifiers, oscillators or tuned circuits.

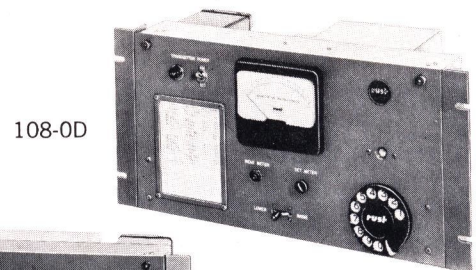

108-0D

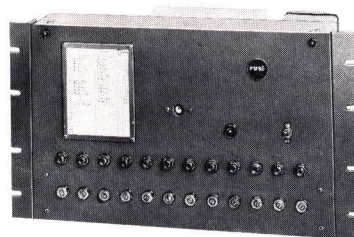

108-1D

*Power (each unit):* 100-130 v, 50-60 cps, 25 va or less. *Function Indication:* By illuminated drum mounted on stepper. *Telephone Line:* Two inexpensive signal circuit lines required; maximum dc loop resistance 4,000 ohms. *Size:* 108-0D Control Unit — 19" W, 8¾" H, 8½" D. 108-1D Transmitter Unit — 19" W, 10½" H, 8½" D.

Part No. 097 2051 00 (Type 108-0D) \$600.00  
Part No. 097 2052 00 (Type 108-1D) \$895.00



## AM TRANSMITTERS

**RUST SERIES F** — Developed to meet the need for an economical but high grade and reliable system to serve the requirements of many single-transmitter installations. Meters show plate voltage, plate MA, antenna amps, frequency deviation and modulation percentage. The metering capacity provides ten different readings plus CAL reading and control capacity of ten two-direction control functions plus fail safe circuit. The unit uses an improved self-correcting ten-function stepping system.

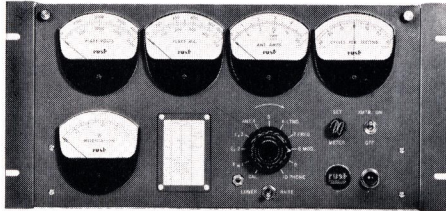

108-0F

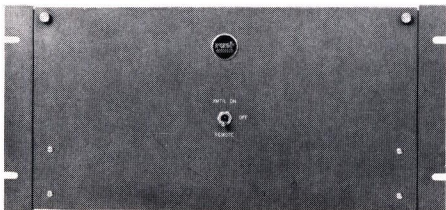

108-1F

*Power:* 108-0F Control Unit — 100-130 v, 50-60 cps, 20 watts. 108-1F Transmitter Unit — 100-130 v, 60 cps, 10 watts. *Function Indication:* 5 meters. *Telephone Line:* Two separate "signal circuit" pairs plus ground return. Maximum dc loop resistance 4,000 ohms. *Size:* 108-0F Control Unit — 19" W, 8¾" H, 8" D. 108-1F Transmitter Unit — 19" W, 8¾" H, 7¼" D.

Part No. 097 3009 00 (Type 108-0F) \$595.00  
 Part No. 097 3012 00 (Type 108-1F) \$400.00

## REMOTE CONTROL SYSTEMS ACCESSORIES

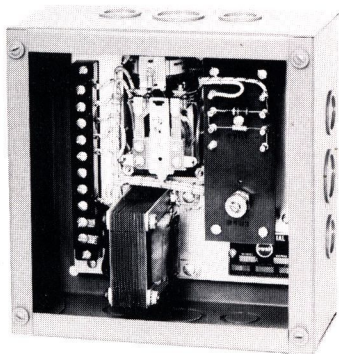

**TOWER LIGHTING UNIT** — Meets FCC requirements by metering lighting current to check bulbs and flasher. Latching relay allows overriding photocell control for Civil Defense purposes. Rated 20 amps ac (Type 108-5A-1).

Part No. 097 1646 00 \$50.00

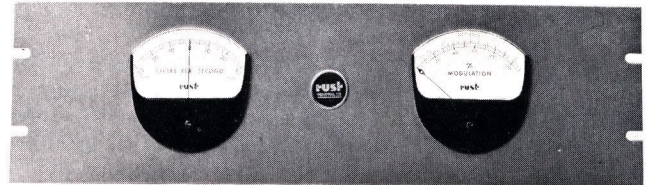

**TWO METER PANEL** — Economical 5¼" rack panel unit using special Marion Medalist meters suitable for General Radio and other similar monitors (Type 108-13B).

Part No. 097 3035 00

\$80.00

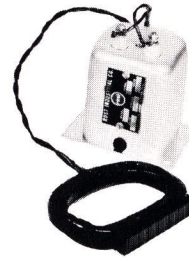

**ANTENNA CURRENT UNIT** — Complete with current transformer for RF currents from 1-10 amps. Uses germanium diode requiring no power source (Type 108-3A).

Part No. 097 1846 00

\$20.00

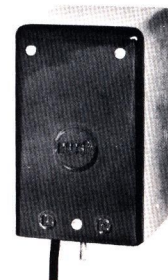

**ROTARY ACTUATOR** — Uses 2 rpm reversible motor replacing control knob. Contains momentary switch and needs no relays. Torque adjustable up to 27 pound inches. Standard shaft ½". Requires 115 v, 60 cps (Type 108-10A).

Part No. 097 1458 00

\$85.00



**CABLE ASSEMBLY** — Factory wired 25' cable assembly included with each five functions ordered with C or D Rust systems (Type 108-34).

Part No. 097 1937 00

\$35.00



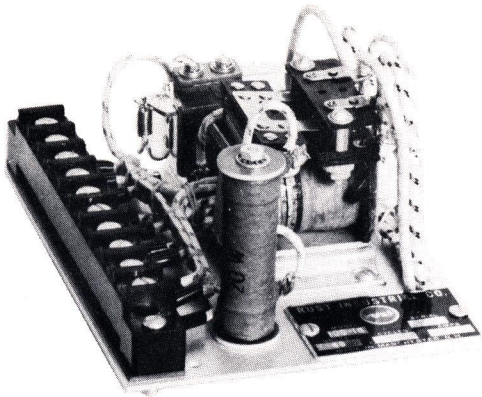

**DUAL MOMENTARY RELAY** — Adapts system to control start-stop pushbutton station or other operation requiring two SPDT relays rated 10 amperes ac (Type 108-18).

Part No. 097 1461 00

\$25.00

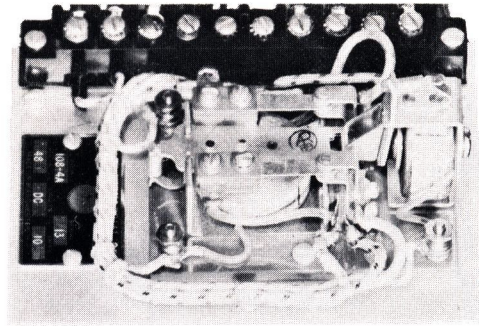

**LATCHING RELAY UNIT** — Improved unit powered by system and providing switching function of double pole, double throw toggle switch rated 10 amps ac (Type 108-4A-1).

Part No. 097 1453 00

\$25.00

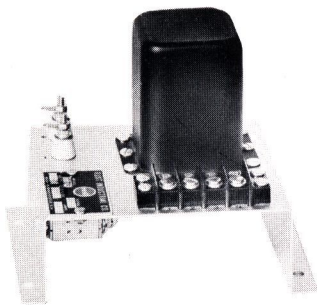

**AC POTENTIAL UNIT** — Designed to operate from 115/230 v, 50/60 cps. Meters line voltage, regulated filament primary voltage, etc. (Type 108-6A).

Part No. 097 2036 00

\$25.00

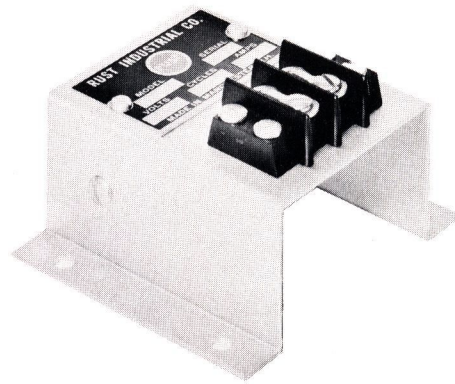

**METER SAMPLING UNIT** — By-passed precision shunt with thyrite protection. Shares existing multiplier for remoting plate voltage. Available in 1 ma (Type 108-8C), 5 ma (Type 108-8D).

Part No. 097 1454 00

(Type 108-8C)

\$15.00

Part No. 097 2049 00

(Type 108-8D)

\$15.00



**MOTORIZED PLATE RHEOSTAT** — For 250-1,000-watt transmitters. Standard 750 ohms, 500 watts, 3,000 v insulation (Type 108-21B).

Part No. 097 2004 00

\$100.00

For Collins 20V Transmitters.

Part No. 097 2069 00

\$100.00

For Collins 550A Transmitters.

Part No. 097 2068 00

\$100.00

For Collins 300J Transmitters.

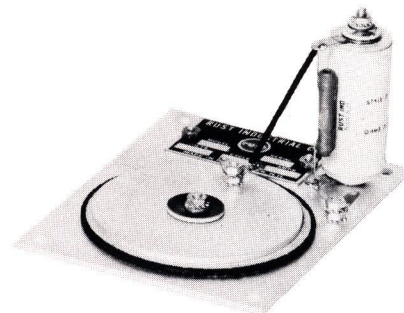

**DC CURRENT UNIT** — Installed in cathode circuits for indication of plate current. With positive thyrite disc overvoltage protector. Available in 300 ma (Type 108-9A-1), 600 ma (Type 108-9B-1), 1,200 ma (Type 108-9C-1) and 2,400 ma (Type 108-9D-1) ratings.

Part No. 097 2016 00

(Type 108-9A-1)

\$15.00

Part No. 097 2017 00

(Type 108-9B-1)

\$15.00

Part No. 097 2018 00

(Type 108-9C-1)

\$15.00

Part No. 097 2019 00

(Type 108-9D-1)

\$15.00



# FM TRANSMITTERS

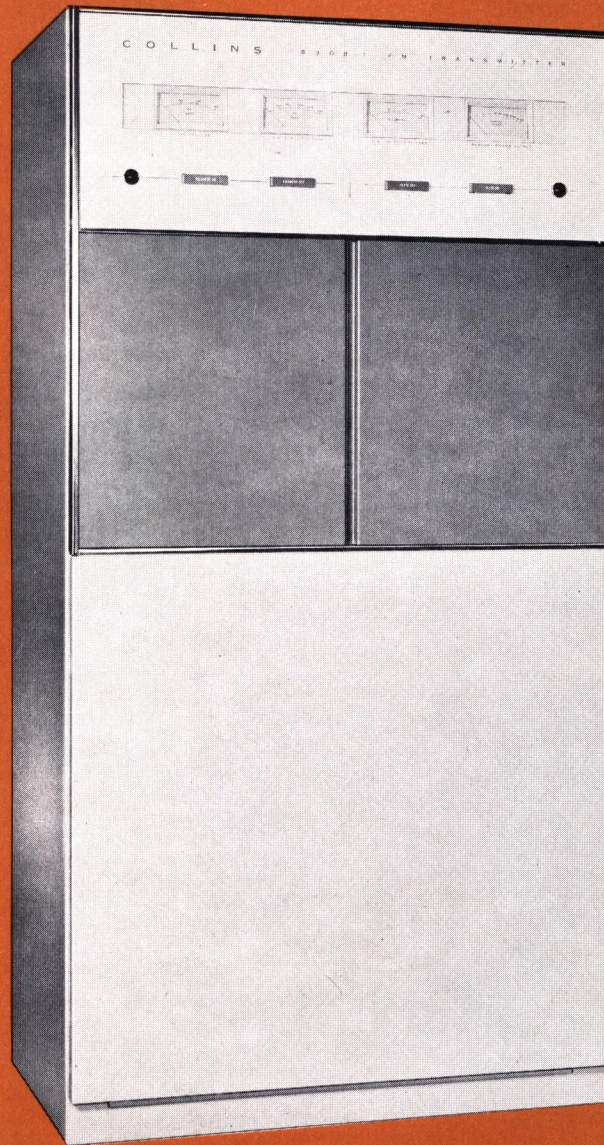

## COLLINS 830B-1 250-WATT FM TRANSMITTER

A complete, self-contained 250-watt FM transmitter, the 830B-1 also serves as the driver in the 830E-1 5,000-watt FM transmitter. Operating in the 88-108 mc frequency range, the 830B-1 includes a direct FM, wide band 10-watt exciter (refer to the description of the 830A-2 on page 23) which provides the driving power for a cavity tuned, high efficiency power amplifier stage.

The power supply uses silicon rectifiers which take

little space, generate a minimum of heat and provide high reliability. The PA stage is self-neutralized and does not require special tuning. The high stability exciter uses plated, non-temperature controlled crystals. Trimmer capacitors are provided for adjusting the crystal to exact frequency.

The unit is pushbutton operated, and all RF circuits are tuned and metered from the front panel. All adjustments, including loading, may be made without



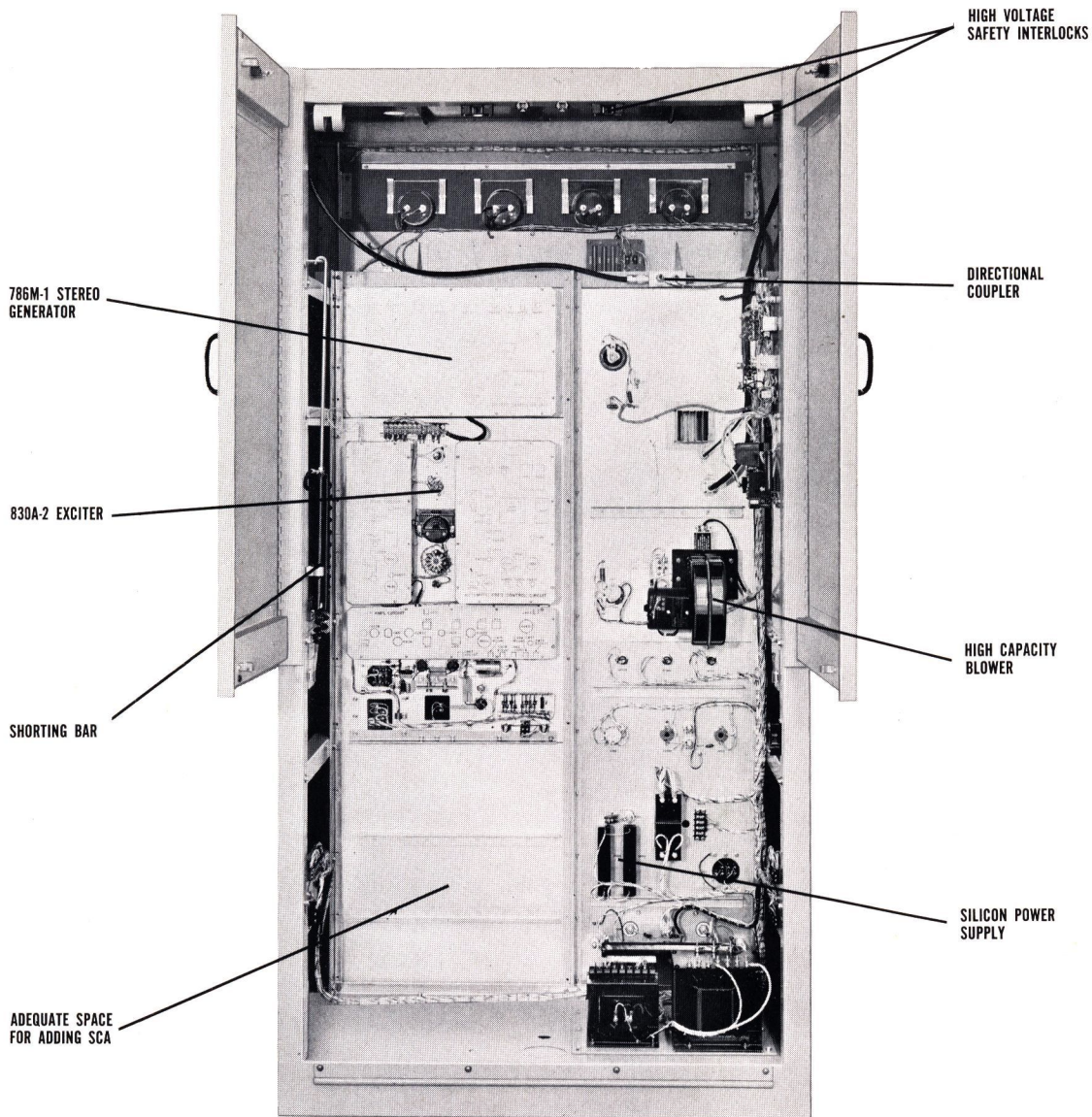

taking the transmitter off the air. Simplified controls make remote operation possible by addition of remote control units.

Provisions are made for connecting frequency and modulation monitors to the unit, and for the addition of self-contained multiplexing and stereo-multiplexing equipment. A wide audio channel modulator in the Collins 830B-1 FM Transmitter eliminates channel cross-talk and assures stable stereo separation. The completely transistorized stereo multiplex system meets FCC specifications without continuous on-the-air adjustment. The SCA multiplex chassis features a

built-in muting switch on the front panel, a monitor meter and a stabilized RC subcarrier oscillator which eliminates unwanted background noise.

Vertical panel construction allows complete accessibility to all components for inspection and maintenance, and allows all cables and wires to be mounted in the back of the unit. The straightforward and human engineered design makes the Collins 830B-1 an attractive, integrated unit in the most modern FM station. The transmitter cabinet features brushed chrome trim, white meters and a high gloss gray, blue-gray and off-white baked enamel.



# FM TRANSMITTERS

The 830B-1 250-watt FM transmitter consists of one power amplifier tube driven by a 10-watt exciter. The 250-watt PA input impedance is 50 ohms nominal, unbalanced. Amplifier output power is 250 watts nominal into a 50 ohm resistive load over the frequency range of 88-108 mc with a maximum SWR of 2:1. The power amplifier output can drive a higher power amplifier or can be fed directly to a harmonic filter and antenna.

Exciter input power is applied to the power amplifier where it is raised to 250 watts of RF power. The power amplifier consists of a forced air cooled ceramic type tetrode whose output is coupled to a higher powered amplifier or antenna by means of a tuned cavity. The degree of coupling or leading is accomplished by a variable capacitor connecting the cavity to the transmission line. A portion of the power amplifier output is taken from the plate tuned cavity for monitoring purposes.

Line power input required is 50/60 cps, one phase. Voltage taps on all 50/60 cps input transformers compensate for line voltage variations from 200-250 v. The 230 v ac is fed to a power transformer which reduces the input voltage to 115 v ac. This reduced voltage is used in the blower (50 cps blower on special order) and control circuits. A second transformer reduces the 115 v ac to 6.3 v for use by the power amplifier filament. The 230 v ac is also fed to a step-up transformer where the power amplifier plate and screen supply voltages are obtained.

The input to the plate and screen supply input voltage is controlled by the plate contactor with plate and screen supply overloads monitored by the control circuits.

**Frequency Range:** 88-108 mc.

**Power Output:** 250 watts.

**Frequency Stability:**  $\pm 1000$  cps.

**Audio Frequency Response:**  $\pm 1$  db, 50-15,000 cps.

**Distortion:**

Less than 1.0%, 50-100 cps.

Less than 0.5%, 100-7500 cps.

Less than 1.0%, 7500-15,000 cps.

**FM Noise Level:** 65 db below  $\pm 75$  kc.

**AM Noise Level:** -55 db rms.

**Harmonic Attenuation:** -70 db.

**Modulation Capability:**  $\pm 100$  kc.

**RF Output Impedance:** 50 ohms.

**Audio Input Level:** +10 dbm,  $\pm 2$  db.

**Power Source:** 200-250 v ac, 60 cps, single phase.

**Power Demand:** 700 watts, 90% power factor.

**Power Line Regulation:** 3%.

**Variations:** Slow line,  $\pm 5\%$ ; Rapid line,  $\pm 3\%$ .

**Tube Complement (one each):**

6U8	5763
12AT7	2E26
6AU6	4CX250B

**Temperature Range:** +10°C to +45°C.

**Humidity:** 0 to 95%.

**Altitude:** 6000 ft.

**Size:** 38" W, 76" H, 27" D.

**Weight:** 650 lbs.

**Part No. 549 2008 (250-watt amplifier)** **Price on Request**  
Consists of 250-watt amplifier with set of tubes and power rectifiers only.

**Part No. 522 2714 (10-watt exciter)** **Price on Request**  
Consists of 10-watt exciter, set of tubes, plug-in transistors, power rectifiers, crystal and instruction book. Complete 830B-1 FM transmitter requires both units listed above.

**No Part Number** **\$277.00**  
Complete set of spare tubes, plug-in transistors plus power rectifiers for 830B-1.

**No Part Number** **\$173.00**  
FCC set of spare tubes, plug-in transistors plus power rectifiers.

**No Part Number** **\$90.00**  
Spare crystal for 830A-2 10-watt exciter.

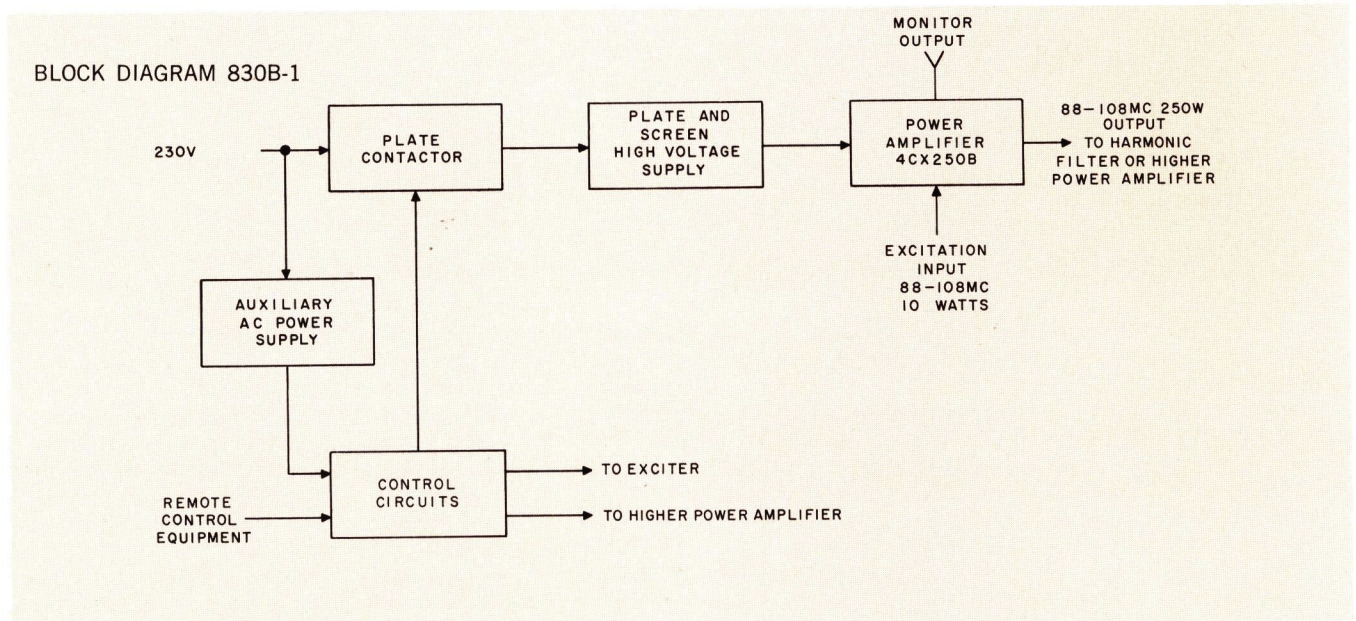



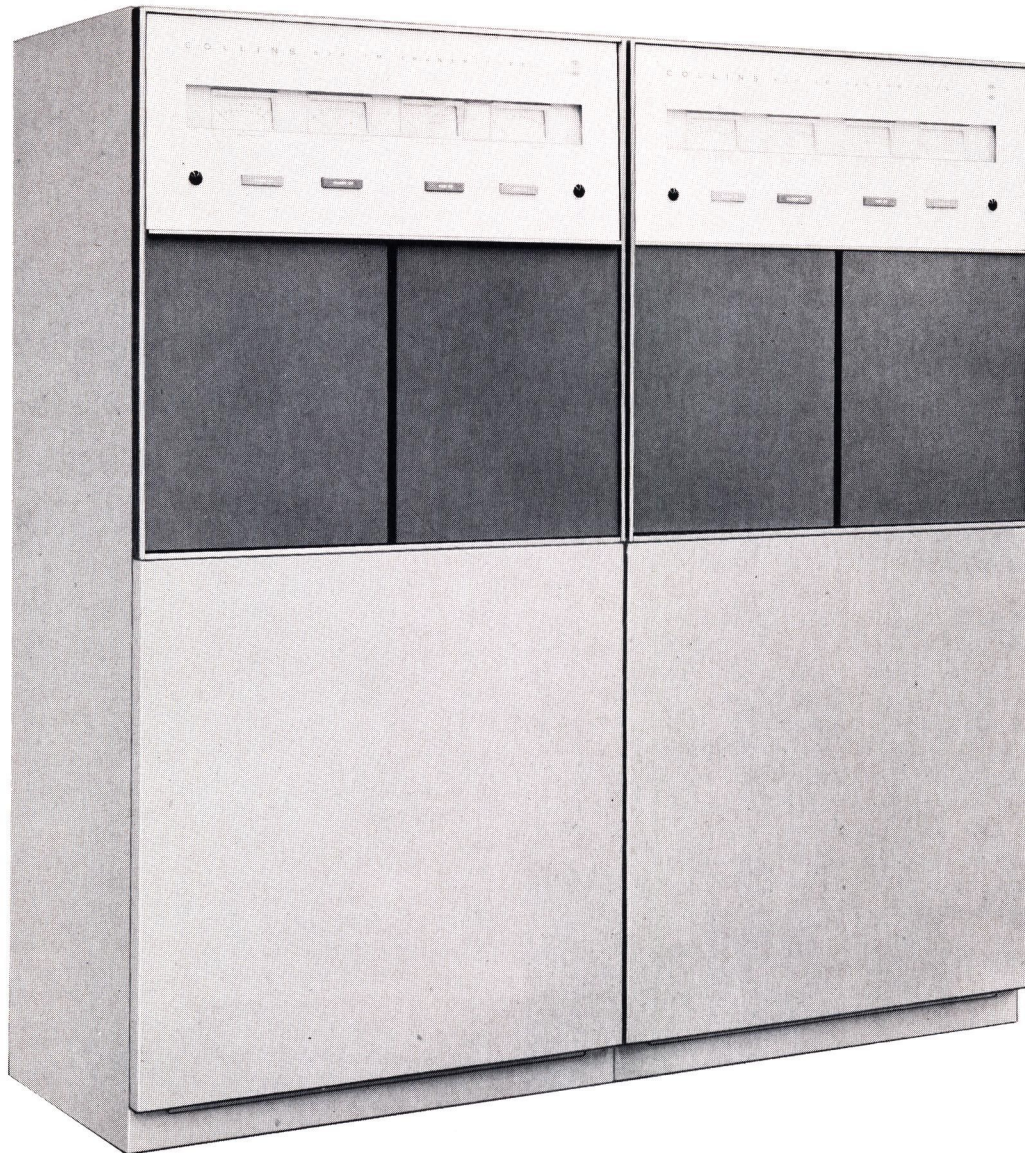

### **COLLINS 830E-1 5,000-WATT FM TRANSMITTER**

Consisting of two identically styled cabinets, the 830E-1 5,000-watt FM Transmitter is made up of an 830B-1 250-watt driver (see description above) and an amplifier unit which increases the 250-watt level to 5,000 watts through the use of a single, cavity tuned, high efficiency power amplifier. The amplifier power supply may utilize silicon rectifiers if specified.

Plate and filament controls, power output adjust, power amplifier filament adjust and plate overload reset may be extended to a remote position. All adjustments of both the driver and amplifier may be made while the 830E-1 is on the air.

Plate voltage, cathode current, line voltage, filament voltage and output power may be monitored remotely. Automatic sequencing assures the proper time delay

and correct sequencing of filament, screen and plate powers. Overload relays are provided for the main line and the power amplifier. These relays are usually connected so that an overload removes line voltage, power amplifier plate voltage and/or power amplifier screen power. The transmitter must be re-energized manually or remotely.

The unit is completely self-contained. The high voltage transformer, directional couplers and filters are mounted inside the cabinet instead of being exposed or in a separate unit adjacent to the transmitter. The 830E-1 is conservatively rated for an extra assurance of reliability. Efficient blowers in the unit force air directly on the 4CX5000A tube.

See also description and specifications included in 830B-1 (250-watt driver for 830E-1) and 830A-2 (10-watt exciter for 830B-1) descriptions.



# FM TRANSMITTERS

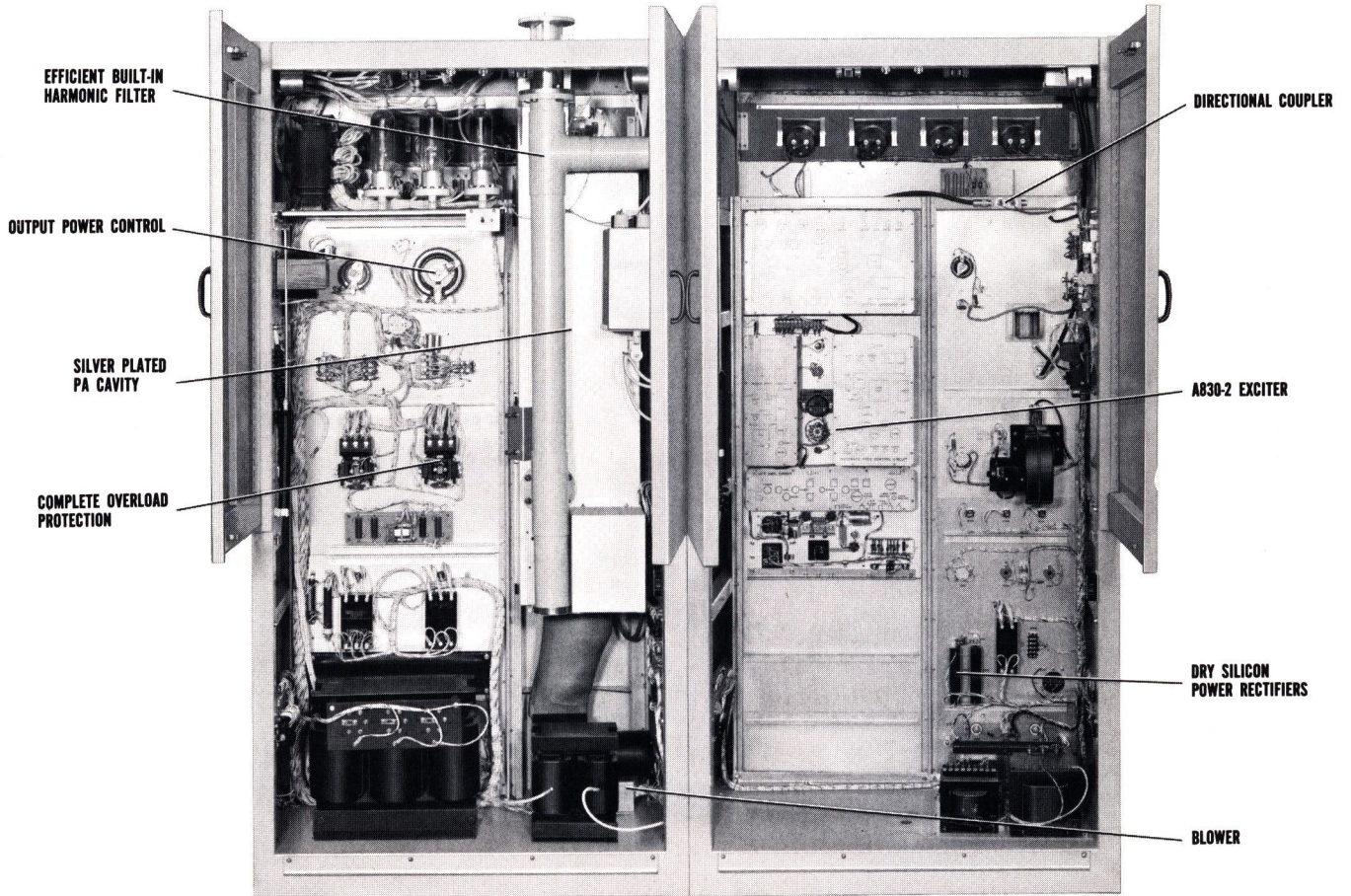



Frequency Range: 88-108 mc.

Power Output: 5,000 watts.

Frequency Stability: ±1000 cps.

Audio Frequency Response: ±1 db, 50-15,000 cps.

Distortion:

Less than 1.0%, 50-100 cps.

Less than 0.5%, 100-7500 cps.

Less than 1.0%, 7500-15,000 cps.

FM Noise Level: 65 db below ±75 kc.

AM Noise Level: -55 db rms.

Harmonic Attenuation: -80 db.

Modulation Capability: ±100 kc.

RF Input Impedance: 50 ohms.

RF Output Impedance: 50-70 ohms unbalanced.

Audio Input Level: +10 dbm, ±2 db.

Power Source:

200-250 v ac, 60 cps, 3 phase.

115 v ac, 60 cps, 1 phase.

Power Demand: 9,500 watts, 90% power factor.

Power Line Regulation: 3%.

Variations: Slow line, ±5%; Rapid line, ±5%.

Tube Complement (one each):

6U8	2E26	6AU6
12AT7	4CX250B	5763
	872A (6)	4CX5000A

Temperature Range: +10°C to +45°C.

Humidity: 0 to 95%.

Altitude: 6000 ft.

Size: 76" W, 76" H, 27" D.

Part No. 549 2009 (5,000-watt amplifier) Price on Request

Part No. 549 2008 (250-watt amplifier) Price on Request

Part No. 522 2714 (10-watt exciter) Price on Request  
Complete 830E-1 FM transmitter requires all three units listed above.

No Part Number \$796.00  
Complete set of spare tubes, plug-in transistors plus power rectifiers for 830E-1.

No Part Number \$647.00  
FCC set of spare tubes, plug-in transistors plus power rectifiers for 830E-1.

No Part Number \$90.00  
Spare crystal for 10-watt exciter.

## COLLINS 1,000 — 20,000-WATT 830 SERIES FM TRANSMITTERS

Collins FM Transmitters with powers of 1,000 (830D-1), 10,000 (830F-1) and 20,000 (830H-1) watts are identical in cabinet style and have similar circuitry and specifications, where applicable, to the 830A-2, 830B-1 and 830E-1 FM Transmitters (see descriptions and specifications above). Contact your Collins Broadcast Sales Engineer for further information on specifications and delivery dates of these units.

Part No. 522 2669 (Type 830D-1) Price on Request

Part No. 522 2670 (Type 830F-1) Price on Request

Part No. 522 2706 (Type 830H-1) Price on Request

## COLLINS 830A-2 10-WATT DIRECT FM EXCITER

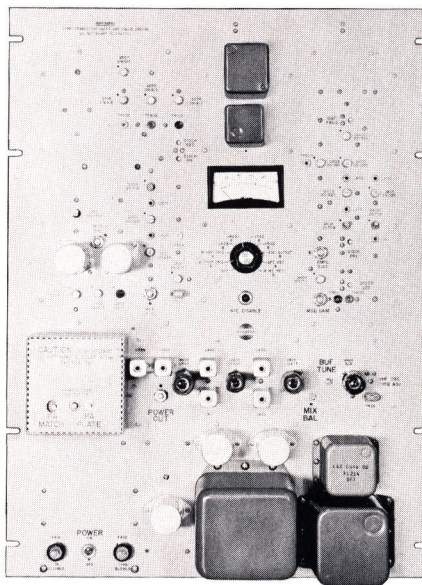

An ideal, independent unit that may be used in educational stations or for other similar low power applications, the Collins 830A-2 is a 10-watt direct FM exciter that accepts audio inputs from a monophonic, stereo (see Collins FM Stereo Multiplex Generator description below), or SCA source by telephone lines or direct connection and modulates an existing carrier to provide an RF drive signal for direct transmission or further amplification. The unit serves as the exciter portion of the Collins 830B-1 and 830E-1 FM Transmitters (see descriptions above) and may be rack mounted in 10-watt installations.

Power Source: 117 v ac ±5%, 50-60 cps, single phase.

Power Supply Voltages:

+20 v dc ±0.1 v, regulation ±0.1 v; ripple 0.5%.

-10 v dc ±0.1 v, regulation ±0.1 v; ripple 0.5%.

+300 v dc ±5.0 v, regulation ±10 v; ripple 1%.

Carrier Frequency Stability: Not more than ±2,000 cps.

FM Noise Level: 65 db below 100% modulation (±75 kc).

AM Noise Level (RMS): 55 db below 100% AM level.

Tube Complement (one each):

6U8	6AU6
12AT7	5763
	2E26

Size: 19" W, 26¼" H, 3⅜" D.

Weight: 42 lbs.

Part No. 522 2714 Price on Request  
Consists of 10-watt exciter, set of tubes, transistors, power rectifiers, crystal and instruction book. Rack mounted unit.

No Part Number \$157.00  
Complete set of spare tubes, plug-in transistors plus power rectifiers for 830A-2.

No Part Number \$93.00  
FCC set of spare tubes, plug-in transistors plus power rectifiers for 830A-2.

No Part Number \$90.00  
Spare crystal for 830A-2 10-watt exciter.



# FM TRANSMITTERS

## COLLINS 786M-1 FM STEREO MULTIPLEX GENERATOR

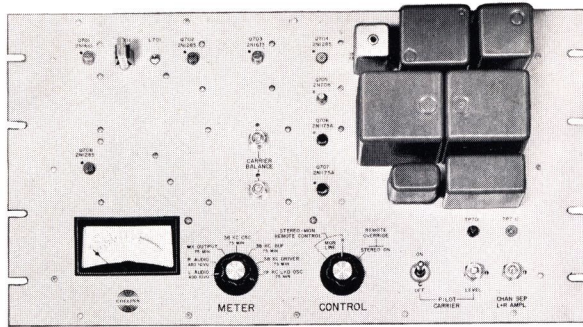

An optional feature of the Collins 830A-2 10-watt FM exciter, the Collins Stereo Multiplex Generator provides an audio modulation signal that meets all the requirements of the FCC-approved system.

The generator circuitry uses a simple time division principle to provide the required signal input to the modulator portion of the exciter. The signal consists of amplitude modulation of the stereophonic subcarrier, which is suppressed to a level less than 1% modulation of the main carrier. A 19 kc pilot subcarrier modulates the main carrier between the limits of 7% and 10%. The modulating signal for the 38 kc subcarrier is the difference between the left and right signals.

The sum of the sidebands resulting from amplitude modulation of the stereophonic subcarrier does not cause a peak deviation of the main carrier in excess of 45% of total modulation (excluding other FM-FM subcarriers) when only a left or right signal exists. Simultaneously in the main channel, the deviation does not exceed 45% of total modulation (excluding other FM-FM subcarriers) when only a left or right signal exists. The main channel never deviates the carrier more than 90% under any condition of stereo operation.

The pre-emphasis characteristics of the stereophonic subchannel are identical with those of the main channel with respect to phase and amplitude at all frequencies. Modulating frequencies on both channels are between 50 and 15,000 cps.

The final stereophonic separation between left and right signals at the transmitter output is greater than

29.7 db at audio modulating frequencies between 50 and 15,000 cps. To achieve this, the ratio of peak main channel deviation to peak stereophonic subchannel deviation, when only a steady state left or right signal exists, is within  $\pm 3.5\%$  of unity for all levels of modulation. Also, the phase difference between the zero points of the main channel signal and the stereophonic subcarrier sidebands envelope, when only a left or right signal exists, does not exceed  $\pm 3^\circ$  for audio modulating frequencies from 50-15,000 cps.

Cross-talk into the main channel caused by a signal in the stereophonic subchannel is attenuated at least 40 db below 90% modulation. Cross-talk into the stereophonic subchannel caused by a signal on the main channel is attenuated at least 40 db below 90% modulation. Modulation of the SCA channel by the main or stereo channel is less than 40 db.

The stereophonic subcarrier is the second harmonic of the pilot subcarrier and crosses the time axis with a positive slope simultaneously with each crossing of the time axis by the pilot subcarrier. At an instant when only a positive left signal is applied, the main channel modulation shall cause an upward deviation of the main carrier frequency, and the stereophonic subcarrier and its sidebands signal cross the time axis simultaneously and in the same direction.

The unit operates in the frequency range of 88 to 108 mc. The specified customer frequency is determined by one crystal in the power oscillator circuit and trimmer capacitors are provided for adjusting the crystal to exact frequency.

### Distortion (either channel):

- Less than 1.0%, 50-100 cps.
- Less than 0.5%, 100-7,500 cps.
- Less than 1.0%, 7,500-15,000 cps.

**Pilot Carrier Stability:**  $\pm 2$  cps at 19,000 cps.

**Separation:** 30 db or greater.

**Output Impedance:** 600 ohms unbalanced.

**Size:** 19" W, 8 $\frac{3}{4}$ " H, 3 $\frac{1}{8}$ " D.

**Weight:** 14 lbs.

<b>Part No. 549 2115</b>	<b>Price on Request</b>
Includes set of plug-in transistors.	
<b>No Part Number</b>	<b>\$49.00</b>
Complete set of spare plug-in transistors for stereo multiplex.	
<b>No Part Number</b>	<b>\$28.00</b>
FCC set of plug-in transistors for stereo multiplex.	

### BLOCK DIAGRAM STEREO MULTIPLEX GENERATOR

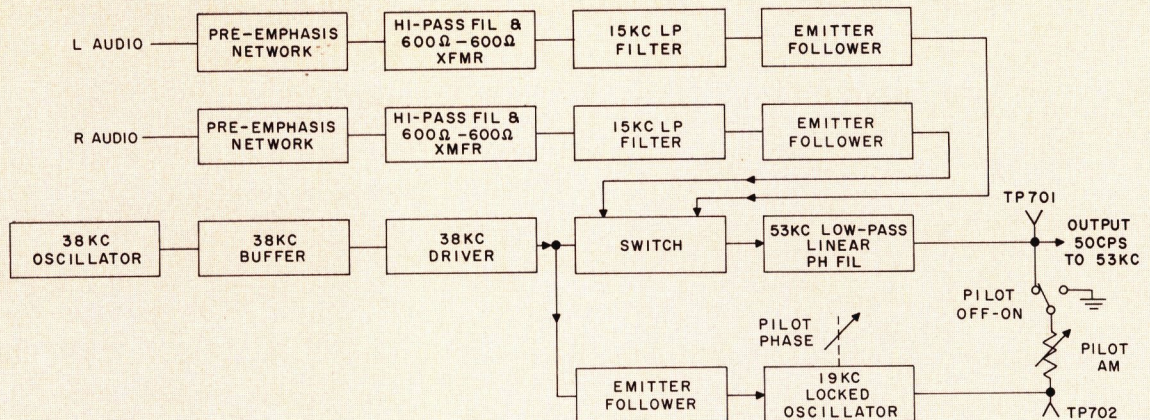



# PHASING



## COLLINS 81M PHASOR

Collins Radio Company maintains a research and development staff which devotes its full efforts to custom design and manufacture of phasing and tuning equipment that will meet critical operating parameters with a minimum of maintenance and adjustment. By instituting its own design and construction, Collins can offer fastest possible delivery, maintain its famous standard of quality and sell at the lowest possible cost.

Engineered into each installation are easily adjusted networks, highest stability, adequate voltage and current safety factors and maximum economy. A cus-

tomers requirements as specified by his consulting engineer are strictly adhered to, and designs are submitted for approval before construction is started.

After the consulting engineer has made channel studies for an available frequency, he will design an array to fit the location, frequency and other requirements. He will determine the pattern shape and size in both the vertical and horizontal planes, the maximum expected operating values of fields in both the nulls (minimum signal areas) and the lobes (maximum signal areas), the proper size, shape, height,



## PHASING

spacing, and orientation of the antenna towers, and the phase relationships and amplitude ratios of the radiation fields of the individual antennas. This information is then submitted to the FCC with the application for a construction permit.

A Collins 81M directional antenna phasing and branching system consists of: a branching circuit in which the power is divided in precisely the amounts of power necessary to give the proper ratio of fields from the individual antennas; an impedance matching circuit to match the power divider input impedance to the common point impedance at which the power input is measured; phase shifting networks in series with each of the transmission lines going to the individual antenna towers; the transmission lines themselves; and the impedance matching network between each of the transmission lines and its associated antenna tower.

The power divider in Collins 81M equipment is usually a resonant tank circuit consisting of a large fixed coil tapped with smaller variable coils for power adjustment. An alternate design uses a group of variable coils, each one feeding a tower; this group then becomes the tank coil of the circuit.

For 1 kw or lower, the capacitive arm of the tank circuit is a capacitor and variable coil connected in series. The variable coil provides tuning adjustment by varying the over-all negative reactance in this branch of the tank. In higher powers, the tank capacitance is usually a variable vacuum capacitor in parallel with one or more fixed capacitors.

Phase shifting networks are "T" designed, with variable coils mechanically connected in tandem for the series arms and a coil and capacitor in series for a shunt arm. Wherever possible, 90° networks — capable of being adjusted  $\pm 30^\circ$  from the design value — are supplied.

Wherever a phase shift network is not required, a series variable coil and capacitor are used to supply variation of  $\pm 20^\circ$  around a 0° setting. They are used for trimming phase shift of current in the towers in which they are used.

"T" networks are also used for impedance matching at the tower base. The network has sufficient latitude of adjustment to match the transmission line impedance to any expected base operating impedance and still permit adjustment of phase shift.

Switching of circuits for day and night operation or directional and non-directional operation is accomplished by impulse-type, toggle-operated RF relays, energized by pushbutton switches on the front panel. The pushbutton automatically removes the plate voltage of the transmitter before pattern switching and restores it when switching is completed. Interlocks on the cabinet doors also remove the plate voltage when doors are opened.

Amplitude and phase controls have counters to assure accurate resetability. In complex arrays requiring additional controls, the controls and counters are behind the tilt-out panel in the lower half of the cabinet.

Power dividing circuits and phase shift networks utilize heavy edge-wound copper ribbon inductors and ceramic cased mica capacitors. Vacuum condensers are used where made necessary by high circulating currents.

Plated 5/16" copper tubing is used for all RF busses and insulation is steatite or Mycalex.

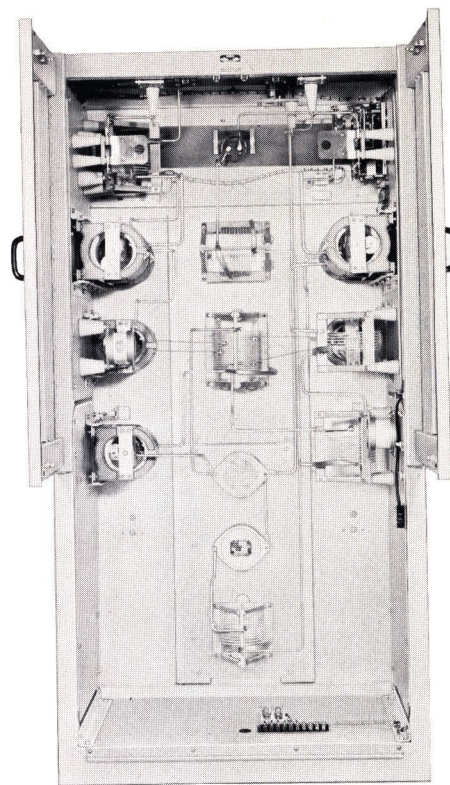

BLOCK DIAGRAM TYPICAL PHASING SYSTEM

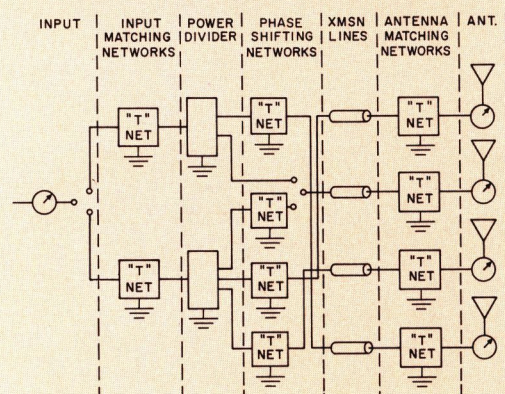

Input and output connections are provided at the top of the phasing cabinet unless otherwise specified. Special terminations are provided for solid dielectric cables in both the phasing cabinet and antenna coupling units.

An input common point RF ammeter is supplied, along with line current meter jacks. Antenna current meters have make-before-break switches, which can be operated without opening the cabinet door on the weatherproof coupling units.

Extensive descriptions of typical systems are available upon request of CDS-377.

*Power:* 1, 5 and 10 kw in 2-, 3-, 4-, 5-, and 6-tower arrays. *Patterns:* Directional day and night, same pattern; directional nighttime only; or different pattern day and night. *Size:* 38" W, 76" H, 27" D. (Complex Collins 81M phasing systems may require two cabinets totaling 76" W.)

No Part Number

Price on Request



## COLLINS 564A-1 PHASE SAMPLING LOOP

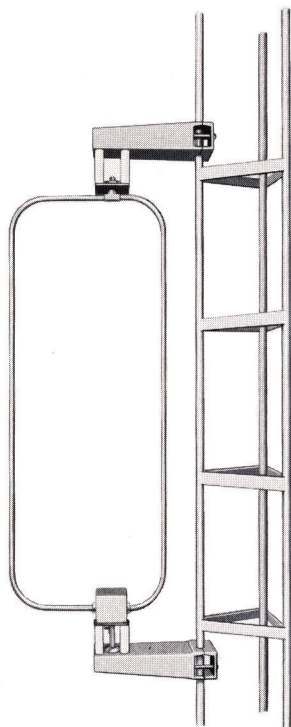

Designed to sample the relative phase relationship of radio frequency energy from 550-1600 kc antenna towers in directional antenna arrays, the Collins 564A-1 is made of two loops of #10 copper wire which may be connected either in series or in parallel. The wires are contained within a loop of 7/8" painted, copper tubing which serves as an electrostatic shield.

A universal coupling permits the loop to be connected to any type of pressurized or unpressurized

air or solid dielectric transmission line. The loop offers a good match to lines of 50-75 ohms impedance. A universal mounting bracket allows the loops to be mounted on any part of the antenna structure.

Size: Approx. 30" W, 7' 6" H. Weight: 50 lbs.

Part No. 522 1518 004

\$115.00

## COLLINS 564A-2 PHASE SAMPLING LOOP

An unshielded loop of galvanized iron pipe. Size: Approx. 42" W, 7' 2" H. Weight: 35 lbs.

Part No. 522 1519 004

\$70.00

## COLLINS 144A-1 ISOLATION COIL

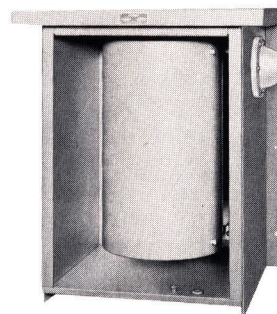

Coil provides isolation for the sampling line in directional arrays, presenting a high impedance for the line across the base insulator. Unit consists of a phenolic coil form which will accommodate 37 turns of RG8/U or similar solid dielectric sampling line. May be mounted on wall of tuning shack or in 49U-1 Housing (pictured). Inductance: Approx. 180 microhenrys. Size: 10" diameter, 18" L. Weight: 6 lbs.

Part No. 522 1520  
Part No. 522 1521 00

(Type 144A-1)  
(Type 49U-1)

\$37.50  
\$98.00

## JOHNSON RF CONTACTORS

The 145-100 and 145-200 contactors are especially designed for high voltage radio frequency switching and dc voltage switching in high voltage rectifier circuits. They require no "holding" power and will operate with a momentary application of voltage.

Standard contactors are supplied with four auxiliary switches: two "normally closed" for control of solenoid voltage and two "normally open" for operation of signal lamps or other related functions. Solenoids are wired for 220 v, 50-60 cps or 110 v, 50-60 cps on special order.

Part No. 097 5511 00	(Type 145-101-13)	\$106.00
Part No. 097 4974 00	(Type 145-102-13)	\$116.00
Part No. 097 5419 00	(Type 145-201-13)	\$125.00
Part No. 097 5420 00	(Type 145-202-13)	\$134.00

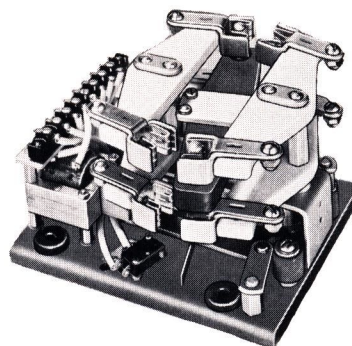

Type No.	Contacts	Maximum Current	Maximum Contact Rating (at 2 mc)	Size
145-101-13	SPDT	4 amps	17 kv, 25 amps	7 7/8"W, 5 1/2"H, 6 1/2"D
145-102-13	DPDT	4 amps	17 kv, 25 amps	7 7/8"W, 5 1/2"H, 6 1/2"D
145-201-13	SPDT	8 amps	22 kv, 25 amps	10 1/2"W, 6 1/4"H, 8 1/4"D
145-202-13	DPDT	8 amps	22 kv, 25 amps	10 1/2"W, 6 1/4"H, 8 1/4"D



# ANTENNAS & TOWERS



## COLLINS 37M FM ANTENNA

A proven design that has been imitated but never duplicated in efficiency during the past decade, the Collins 37M Antenna still maintains its position of leadership in FM broadcasting.

The advanced design features of the unit make it an ideal antenna for stereo and multiplex operations. The aerodynamic simplicity and low weight of the 37M provide greater efficiencies and savings in new tower costs, erection time and maintenance expense. These features also eliminate undue oscillating and weaving of the tower and antenna.

The Collins 37M Ring Antenna consists of only two basic parts: the radiating ring and the connecting inter-ring transmission line. Any number of rings, either odd or even, may be used to provide maximum flexibility in high power gain.

Antenna arrays mounted on  $1\frac{5}{8}$ " or  $3\frac{1}{8}$ " line are available for handling transmitter powers up to 20 kw. Antenna assemblies on  $1\frac{5}{8}$ " line are rated for power inputs at base of antenna up to 3 kw for a single ring array; 10 kw for four or more rings. Antenna assemblies on  $3\frac{1}{8}$ " line are rated for power inputs up to 3 kw per ring at base of antenna with maximum of 20 kw for seven or more rings.

Antennas for power inputs in excess of 20 kw incorporate the use of a "T" feed at center of array.

Only one inter-element transmission line is required to feed all rings in a multiple element array. The individual radiating rings are identical mechanically and electrically. They are both shunt fed and supported by a single interconnecting feed line, which consists of modified lengths of standard EIA rigid



coaxial line insulated with Teflon. The Collins 37M FM Antenna feed system has a stub at the top of the array which is capacitive and adequately removes the inductive reactance created by the shunt feed on the ring. The 37M terminates in a standard EIA 50 ohm flange connection on the bottom element of the array for coupling directly to 1 5/8" or 3 1/8" transmission line.

The horizontal radiation pattern of the Collins 37M FM Antenna is essentially circular for both top mounting and side mounting arrays. A maximum deviation of only 1 db is obtained in the top mounted arrangement, while the circular pattern of the side mounted array will generally equal that of the top mounted antenna. The extent of deviation from a circular pattern in the side mounted antenna is dependent on the type and size of tower on which the antenna is mounted. In cases of very large supporting structures and in all cases where guy wires are used, factory recommendations should be requested on spacing of insulators and guy wires and mounting of the antenna. Insulators should be placed where the guys attach to the tower and guys should also be broken with insulators every three feet for 15 feet in the immediate area of the antennas.

The voltage standing wave ratio of the Collins 37M Antenna can be maintained at better than 1.1:1 due to the inherently high stability of the tuning system. The capacitor plates of the 37M are adjustable for optimum performance and equal power distribution through all rings. These features allow an accurate prediction of the gain from the given number of loops in the array. Adequate bandwidth virtually eliminates detuning effects caused by changes in atmospheric conditions. The bandwidth and linearity of the antenna are more than adequate for multiplexing service.

The compactness and simplicity of the 37M allow maximum efficiency in ice removal. Each ring may be equipped with an internally mounted, 200-watt heating unit which consists of a cartridge type element inside each of the tuning capacitor plates and an additional flexible heating element extending the full circumference on the inside of the ring. The simplicity

of the heating arrangement makes it possible to replace the elements in the field if necessary. The absence of large masses of metal assures efficient and practical deicing of the antenna and capacitor, which is the most critical part of the antenna when icing occurs.

The 37M Antenna is easy and quick to erect. There are no heavy hoisting problems so that many hours of erection time can be saved. Support brackets are specially fabricated for each installation to match the tower and mounting arrangement, thus minimizing erection problems at the site.

Either guyed or self-supporting towers will in nearly all cases support the side mounting 37M. Towers which support top mounting television antenna arrays increase their usefulness with the addition of a side mounting 37M Antenna.

Top or pole mounting design is available on special order for installation on towers where no TV antenna is present or planned. This type of mounting provides the maximum in height and coverage. The light weight and windloading of the top mounting series allows erection on most guyed and self-supporting towers without extensive tower modification.

Further information and quotations on the 37M FM Directional Antenna will be supplied upon request.

Part No.	Type and Number of Rings	Side Mounted, Less Mast Rings Mounted on	
		1 5/8" Line	3 1/8" Line
013 0020	37M-1	\$ 585.00	\$ 635.00
013 0030	37M-2	900.00	990.00
013 0040	37M-3	1,350.00	1,498.00
013 0050	37M-4	1,800.00	1,980.00
013 0060	37M-5	2,250.00	2,475.00
013 0070	37M-6	2,700.00	2,970.00
013 0080	37M-7	3,150.00	3,465.00
013 0090	37M-8	3,600.00	3,960.00
097 1693	37M-10	4,500.00	4,950.00
097 1528	37M-12	5,400.00	5,940.00

For top mounted, with mast rings mounted on 1 5/8" Line or 3 1/8" Line, Part Number remains the same for the specified number of rings.

**No Part Number**  
37M FM Antennas for power inputs over 20 kw. **Price on Request**

**Part No. 013 0099** **\$80.00**  
Deicer per bay installed at the factory.

**Part No. 098 0025** **\$18.75 each**  
Replacement heating element. Two required per ring.

Collins Type	No. of Rings	Power Gain	Field Gain	A Feet	On 1 5/8" Line				On 3 1/8" Line			
					B	Weight	B	Weight	B	Weight	B	Weight
37M-1	1	.9	.95	2-6±	24	23	32	46				
37M-2	2	2.0	1.41	12-6±	68	55	100	100				
37M-3	3	3.0	1.73	22-6±	114	86	170	175				
37M-4	4	4.1	2.02	32-6±	160	119	240	240				
37M-5	5	5.2	2.28	42-6±	206	152	310	305				
37M-6	6	6.3	2.51	52-6±	252	185	380	370				
37M-7	7	7.3	2.70	62-6±	298	218	450	435				
37M-8*	8	8.4	2.90	72-6±	344	251	520	500				

Collins Type	No. of Rings	Pwr. Gain	A Ft.	B Ft.	C Ft.	On 1 5/8" Line					On 3 1/8" Line						
						D Ft.	E Dia.	F Dia.	G Lbs.	H Ft.-Lbs.	Dead Wt.	D Ft.	E Dia.	F Dia.	G Lbs.	H Ft.-Lbs.	Dead Wt.
37M-1	1	.9	6	3		4-7	3 1/8"	3 1/8"	50	230	223	4-7	3 1/8"	3 1/8"	68	312	250
37M-2	2	2.0	16	10±	4	10	4 1/2"	4 1/2"	239	2,390	305	12-3	4 1/2"	4 1/2"	291	3,565	360
37M-3	3	3.0	26	20±	7	14-5	6 1/8"	6 1/8"	403	5,803	736	14-4	6 1/8"	6 1/8"	486	6,950	825
37M-4	4	4.1	36	30±	10	19	7 1/8"	7 1/8"	564	10,716	1169	18-9	7 1/8"	7 1/8"	678	12,713	1290
37M-5	5	5.2	46	40±	12	23	8 1/8"	7 3/4"	747	17,181	1652	22-8	9 1/8"	9 1/8"	919	20,769	2128
37M-6	6	6.3	56	50±	14	27-2	9 1/8"	8 1/8"	951	25,867	2285	26-7	10 3/4"	9 1/8"	1173	31,260	2770
37M-7	7	7.3	66	60±	15	31	10 3/4"	8 1/8"	1175	36,425	3218	31-3	10 3/4"	8 1/8"	1388	43,375	3485
37M-8*	8	8.4	76	70±	16-6	34-9	11 3/4"	9 1/8"	1417	49,241	4051	34-8	12 3/4"	11 3/4"	1696	58,682	4650

\*up to 12 bays on application.



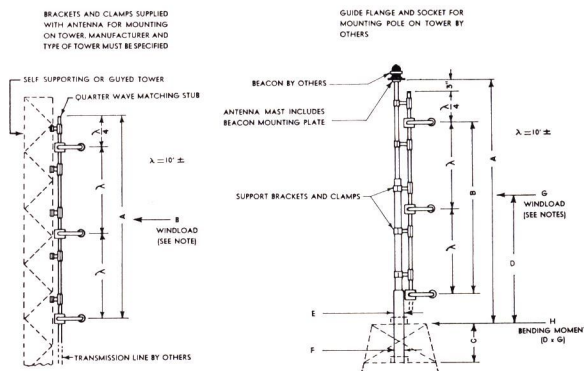

## ANTENNAS & TOWERS

### ANDREW FITTINGS FOR COLLINS 37M FM ANTENNA

The following end terminals and fittings are required for connection of various types of transmission line to Collins 37M FM Antenna. The 37M is supplied with 1 5/8" or 3 1/8" line. The following lists only Andrew fittings for antenna end of transmission line to antenna line. Be sure to specify correct fitting for transmitter end.

ANDREW H2, 3 1/8" Heliac to 3 1/8" 37M: 22R EIA Flange and 15093 Inner Connector.

ANDREW H5, 7/8" Heliac to 1 5/8" 37M: 75R EIA Flange and 1860 Reducer (inner connectors supplied with 75R and 1860).

ANDREW H7, 1 5/8" Heliac to 1 5/8" 37M: 77R EIA Flange (with inner connector).

ANDREW H7, 1 5/8" Heliac to 3 1/8" 37M: 77R EIA Flange (with inner connector) and 1861 Reducer.

AMPHENOL RG 17U, 7/8" Solid to 1 5/8" 37M: 12418-1 Plug, 15069 Inner Connector and 2361 Adapter.

ANDREW 740, 7/8" Semi-flexible to 1 5/8" 37M: 1860 Reducer (with inner connector).

ANDREW 560, 7/8" Rigid to 1 5/8" 37M: 1860 Reducer (with inner connector).

ANDREW 561, 1 5/8" Rigid to 1 5/8" 37M: 15069 Inner Connector.

ANDREW 562A, 3 1/8" Rigid to 1 5/8" 37M: 1861 Reducer (with inner connector).

ANDREW 562A, 3 1/8" Rigid to 3 1/8" 37M: 15093 Inner Connector.

### AM AND FM TOWERS

Collins furnishes a wide selection of both self-supporting and guyed antenna towers to meet the requirements of any AM or FM installation.

Towers are normally supplied with a protective coating of rust inhibitive paint prior to shipment, although they can be supplied with a galvanized finish at a slightly higher price. Galvanized is recommended in locations where the tower will be subjected to salt water spray, extreme humidity or other corrosive conditions. The finish coat is normally supplied by the tower erector and is in keeping with FAA requirements.

All hardware, fittings, guy insulators, anchor steel and base insulator (where required) are supplied with each tower. The applicable FCC (FAA) lighting kit and wiring are also provided.

### UTILITY TOWERS

Available in six basic designs shown, Utility towers meet or exceed RETMA specifications. In the five standard models, steel pipe members are welded together in 20-foot sections, except for the top section length which is according to individual specification. The Type 170 KD tower is of bolted angle-iron construction in 10-foot sections.

Anchors are individually designed to meet the requirements of each tower installation. The I-beam used is imbedded in a concrete slab re-inforced with steel rods and with an earth fill on top.

Each section receives one coat of rust inhibitive, primer paint. Guy lines are galvanized and have a minimum breaking strength of at least twice the maximum calculated loads.

No Part Number

Prices on Request

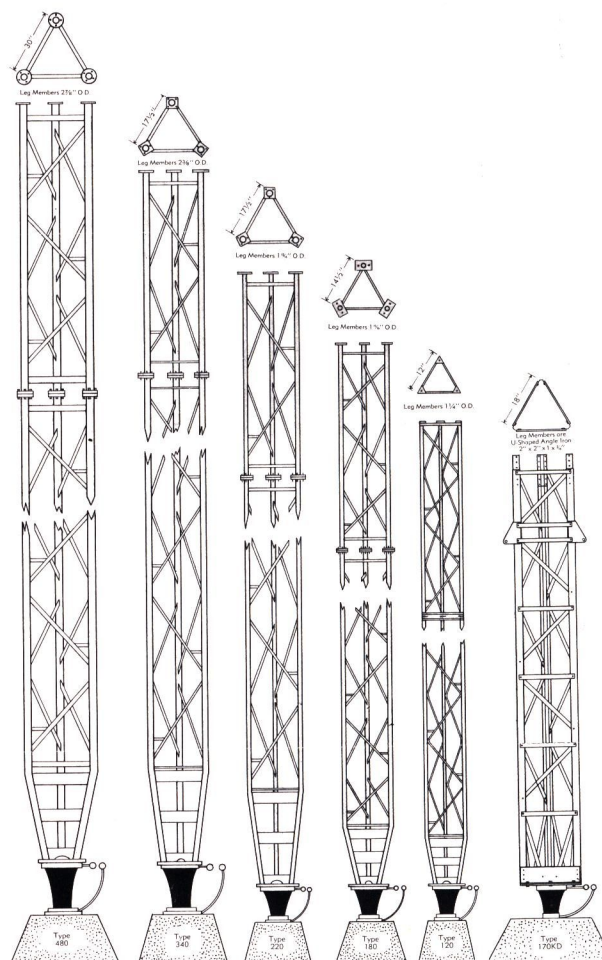

Tower Type	Maximum Recommended Height	Tower Width	Weight Per Foot*	Type of Base Insulation
480	480 ft.	33 in.	28 lbs.	Locke or Lappe
340	350 ft.	19 7/8 in.	17 lbs.	Utility 3401
220	250 ft.	19-7/16 in.	12 1/2 lbs.	Utility 3401
180	200 ft.	16-3/16 in.	10 lbs.	Utility 2201
120	200 ft.	13 1/4 in.	8 lbs.	Utility 2201
170KD	320 ft.	18 in.	17 lbs.	Utility 3401

\*Tower steel only. Weight of guys, insulators, etc., not included.



## SWAGER DURA TOWERS

Constructed of tubular steel 20 feet in length, these strong towers use 2" OD tubing for leg members and 7/8" OD tubing for diagonal and horizontal bracing. Connecting plates are of 3/8" steel and base plates are 3/4" steel.

All horizontal bracing is 20" apart to form a natural ladder on all three sides of the tower. Sections may be interchanged or rotated since all three sides are of equal dimensions.

Towers are supplied complete with all hardware, insulators and anchor kit.

No Part Number

Prices on Request

## HUGHEY & PHILLIPS RING TRANSFORMER



For use wherever 60 cps energy must be transferred across two points with very low capacitance or at very high voltages. Provides a highly reliable, low capacity means of supplying power across base insulator or insulated radio towers employed as radiators. Their relatively large spacing and low capacity between windings make these isolation transformers desirable for use in directional arrays, and especially with radiators which develop very high voltages across the base insulators. No tuning or RF adjustments are necessary. Available in load capacities of 1750 watts (Model TI 2017) and 3500 watts (Model TI 2035).

Part No. 097 6920 00	(Type TI 2017)	\$315.00
Part No. 099 0365 00	(Type TI 2035)	\$360.00

## COPPER GROUND STRAP

This fine quality copper ground strap is available in two sizes: 2" x .032" (4.02' per lb.), and 4" x .032" (2.01' per lb.).

Part No. 097 1445 00	(2" strap)	\$ .79 per lb.
Part No. 097 0811 00	(4" strap)	\$ .79 per lb.

## AUSTIN RING TRANSFORMER



Available with load capacities of 1750 (A-2101), 3000 (A-1971) and 5000 watts.

Part No. 097 3362 00	(Type A-2101)	\$313.00
Part No. 097 5220 00	(Type A-1971)	\$354.00
No Part Number (5,000 watts)		Price on Request

## FISHER-PIERCE 63305-C BEACON LIGHT CONTROL

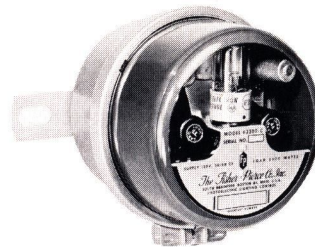

Designed to be mounted on either curved or flat surfaces, the 63305-C will automatically control broadcast tower, billboard or street lighting system directly or with auxiliary controllers. Operated by stable phototube with high sensitivity to north sky illumination, which is predictable and smooth in decline to darkness.

*Power Requirements:* 105-130 v, 50-60 cps. *Built-in Load Contactor:* Single Pole, Single Throw and Single Break. *Load Rating:* 3,000 watts normally closed. Closed at night.

Part No. 097 1698 00	\$60.00
----------------------	---------

## TRUSCON MESH GROUND SCREEN

Expanded copper mesh ground screen is for use beneath base of antenna tower to increase soil conductivity. Available in 8' x 24' sheets.

Part No. 013 0107 00	\$51.00 per sheet
----------------------	-------------------

## COPPER GROUND WIRE

Bare #10 copper ground wire is used for ground radials. Wire attaches to mesh ground screen. *Weight:* 31.8' per lb.

Part No. 421 1010 001	\$ .60 per lb.
-----------------------	----------------



# TRANSMISSION LINES

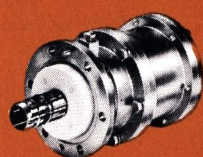
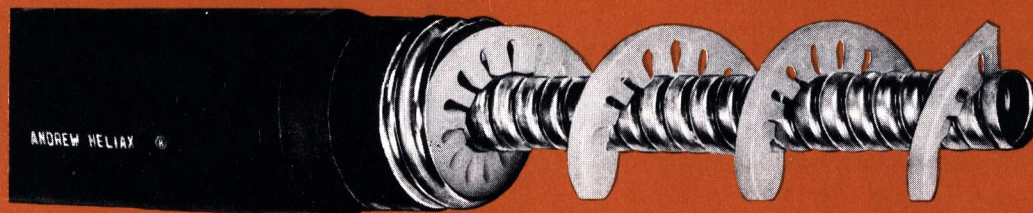

22R



1062

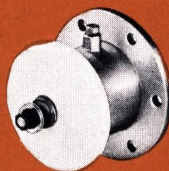

2062



1262A

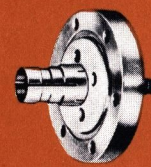

1862

## ANDREW H2 HELIAX TRANSMISSION LINE

A high power, extremely flexible cable, the H2 3 1/8" HeliAx is especially suited for HF, FM, TV and UHF service. The outer conductor is corrugated copper-clad steel and the inner conductor is high conductivity copper tubing. The insulating helix is low-loss polyethylene. The cable has a continuous black polyethylene jacket for added corrosion protection and abrasion resistance. Its continuous splice-free construction assures trouble-free service and its great flexibility eases installation.

	50 Ohms	75 Ohms
Type Number:	H2-50	H2-75
Maximum Frequency:	1400 mc	30 mc
Velocity:	92%	92%
Peak Power Rating:	440 kw	290 kw
Outer Conductor Diameter:	3 3/4"	3 3/4"
Inner Conductor Diameter:	1.355"	0.820"
Weight (lb. per foot):	3	3

Part No. 099 0388                      \$20 per length plus \$9.00 per foot

## ANDREW H2 HELIAX TRANSMISSION LINE ACCESSORIES

**EIA FLANGE** — Includes inner connector, hardware and "O" ring gasket. 50 ohms (Type 22R) or 75 ohms (Type 22R-75).

Part No. 099 0389 00	(Type 22R)	\$100.00
Part No. 099 0390 00	(Type 22R-75)	\$100.00

**MITER ELBOW** — Has swivel flanges at each end. Includes inner connector, hardware and "O" ring gasket. 50 ohms (Type 1062) or 75 ohms (Type 1072).

Part No. 097 5621 00	(Type 1062)	\$80.00
Part No. 099 0391 00	(Type 1072)	\$80.00

**END TERMINAL** — Mates to 3 1/8" flange. 50 ohms (Type 2062) or 75 ohms (Type 2072).

Part No. 099 0392 00	(Type 2062)	\$60.00
Part No. 099 0393 00	(Type 2072)	\$60.00

**GAS BARRIER** — Includes gas inlets on both sides. Used to join pressurized lengths to unpressurized lengths of cable. 50 ohms (Type 1262A) or 75 ohms (Type 1272).

Part No. 097 5754 00	(Type 1262A)	\$75.00
Part No. 099 0394 00	(Type 1272)	\$75.00

**REDUCER** — Connects 3 1/8" EIA flange to 1 5/8" EIA flange. 50 ohms. (Type 1862).

Part No. 099 0395 00	\$75.00
----------------------	---------

**HANGER** — Used at 5' intervals with H2 HeliAx (Type 22417).

Part No. 099 0514 00	\$16.00
----------------------	---------

**INSULATED HANGER** — Used at 5' intervals with H2 HeliAx (Type 22418).

Part No. 099 0515 00	\$20.00
----------------------	---------

**GROUNDING KIT** — Provides a positive ground connection to grounded tower. May be factory installed if desired (Type 23145).

Part No. 099 0516 00	\$25.00
----------------------	---------



## ANDREW H3 HELIAX TRANSMISSION LINE

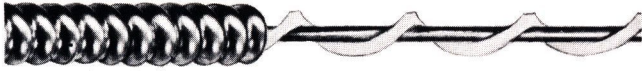

A low-loss, highly flexible coaxial cable, the H3 3/8" Heliax is ideally suited for VHF communication, low power signal measurement, and RF distribution and instrumentation systems. This cable can be hand formed around obstructions and easily pulled through conduit. Both inner and outer conductors are of high conductivity copper with air dielectric insulation for low attenuation. H3 is manufactured in continuous splice free lengths and fittings may be factory attached if desired. All cables are shipped under pressure and should be maintained under pressure. The cable is completely weatherproof and immune to saltspray, temperature fluctuations and other environmental conditions.

Type Number:	H3-50
Characteristic Impedance:	50 ohms
Maximum Frequency:	10,800 mc
Velocity:	89.5%
Peak Power Rating:	10 kw
Outer Conductor Diameter:	0.500"
Inner Conductor Diameter:	0.162"
Weight (lb. per foot):	0.234

Part No. 099 0008 \$8.00 per length plus \$ .72 per foot

## ANDREW H5 HELIAX TRANSMISSION LINE

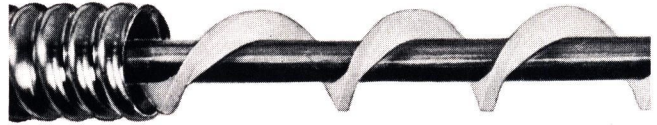

The preferred RF cable for VHF/UHF communications, AM, FM and microwave systems operating at frequencies up to 3000 mc, the H5 7/8" Heliax is manufactured from high conductivity copper and offers three unique properties: performance, strength and flexibility. Produced in continuous splice free lengths, H5 provides the lowest possible VSWR. It is available also with black polyethylene jacket or with Teflon insulation. Connectors may be either field or factory attached and are fully compensated electrically to assure excellent performance.

	50 Ohms	75 Ohms
Type Number:	H5-50	H5-75
Maximum Frequency:	5200 mc	30 mc
Velocity:	92%	92%
Peak Power Rating:	44 kw	29 kw
Insulation:	Poly.	Poly.
Outer Conductor Diameter:	1.005"	1.005"
Inner Conductor Diameter:	0.358"	0.229"
Weight (lb. per foot):	0.421	0.410

Part No. 099 0204 (Type H5-50) \$12.00 per length plus \$1.40 per foot  
 Part No. 099 0398 (Type H5-75) \$12.00 per length plus \$1.30 per foot

## ANDREW H3 HELIAX TRANSMISSION LINE ACCESSORIES

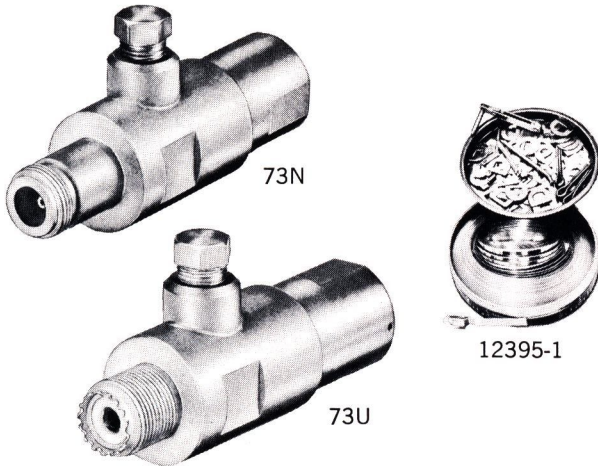

73N CONNECTOR — Type N jack mates with Type N plug, UG-21D/U (Type 10804-36).

Part No. 099 0396 00 \$16.00

73U CONNECTOR — Type UHF jack mates with Type UHF plug, PL-259A (Type 10805-1).

Part No. 099 0397 00 \$8.00

WRAPLOCK — Stainless steel wraplock used to attach cable to tower at five foot intervals (Type 12395-1).

Part No. 097 5010 00 \$12.50

## ANDREW H5 HELIAX TRANSMISSION LINE ACCESSORIES



EIA FLANGE — Includes inner connector, hardware and "O" ring gasket. 50 ohms (Type 75R) or 75 ohms (Type 75R-75).

Part No. 099 0283 00 (Type 75R) \$16.00  
 Part No. 099 0399 00 (Type 75R-75) \$16.00

TYPE N JACK — Mates with Type N plug (UG-21D/U). 50 ohms (Type 75N).

Part No. 099 0400 00 \$16.00

UHF JACK — Mates with UHF plug (PL-259A). Not recommended for use above 470 mc. 50 ohms (Type 75U) or 75 ohms (Type 75U-75).

Part No. 099 0401 00 (Type 75U) \$16.00  
 Part No. 099 0402 00 (Type 75U-75) \$16.00



# TRANSMISSION LINES



**END TERMINAL** — For use below 174 mc only. 50 ohms (Type 75T) or 75 ohms (Type 75T-75).

Part No. 099 0281 00 (Type 75T) \$20.00  
 Part No. 099 0403 00 (Type 75T-75) \$20.00

**MITER ELBOW** — Has EIA swivel flanges on both ends. Includes inner connector "O" ring gasket and hardware. 50 ohms (Type 1060) or 75 ohms (Type 1070).

Part No. 099 0404 00 (Type 1060) \$30.00  
 Part No. 099 0405 00 (Type 1070) \$30.00

**GAS BARRIER** — Connects pressurized cable to unpressurized cable. 50 ohms (Type 1260A).

Part No. 099 0203 00 \$32.00

**REDUCER** — Connects 1 5/8" and 7/8" EIA flanges. Includes two inner connectors, "O" rings and hardware. 50 ohms (Type 1860).

Part No. 097 5405 00 \$40.00

**INNER CONNECTOR** — Used to join 7/8" EIA flanges. 50 ohms (Type 18275) or 75 ohms (Type 25385).

Part No. 099 0406 00 (Type 18275) \$4.00  
 Part No. 099 0407 00 (Type 25385) \$4.00

**INNER CONDUCTOR ADAPTER** — Connects 7/8" 50 ohm EIA to 7/8" 51.5 ohm EIA (Type 4850).

Part No. 097 5958 00 \$8.00

**HOISTING KIT** — Used to hoist Heliac or pull through conduits. Also used as top anchor on vertical installations (Type 19256A).

Part No. 099 0408 00 \$5.00

**GROUNDING KIT** — Provides positive ground connection to tower (Type 24810).

Part No. 099 0409 00 \$2.80

**INSULATED HANGER** — Used to attach Heliac to base insulated tower. May be bolted or wraplocked (Type 11662-2).

Part No. 099 0410 00 \$4.00

**WRAPLOCK** — Stainless steel wraplock used to attach cable to tower at five foot intervals (Type 12395-1).

Part No. 097 5010 00 \$12.50

## ANDREW H7 HELIAX TRANSMISSION LINE

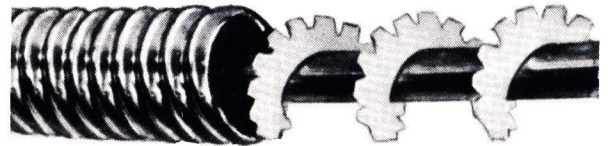

Often the specified air dielectric cable for medium power FM and high frequency antenna installations, the H7 1 5/8" Heliac is also popular at microwave frequencies because of its very low attenuation. As one continuous splice free length from transmitter to antenna, Heliac H7 eliminates connector maintenance problems. This cable will outlast rigid copper line or semi-flexible aluminum cable, has greater crushing strength, is highly resistant to impact damage and is lightweight. H7 is also available with black polyethylene jacket.

	50 Ohms	75 Ohms
Type Number:	H7-50	H7-75
Maximum Frequency:	2800 mc	30 mc
Velocity:	91%	91%
Peak Power Rating:	145 kw	100 kw
Outer Conductor Diameter:	1.830"	1.830"
Inner Conductor Diameter:	0.688"	0.430"
Weight (lb. per foot):	0.875	0.718

Part No. 099 0235 (Type H7-50) \$16.00 per length plus \$3.00 per foot  
 Part No. 099 0411 (Type H7-75) \$16.00 per length plus \$2.80 per foot

## ANDREW H7 HELIAX TRANSMISSION LINE ACCESSORIES

**EIA FLANGE** — Includes "O" ring gasket, inner connector and hardware. 50 ohms (Type 77R) or 75 ohms (Type 77R-75).

Part No. 097 5436 00 (Type 77R) \$40.00  
 Part No. 099 0412 00 (Type 77R-75) \$40.00

**TYPE N JACK** — Mates with Type N plug (UG-21D/U). 50 ohms (Type 77N).

Part No. 099 0237 00 \$40.00

**UHF JACK** — Mates with Type UHF plug (PL-259A) or equivalent. 50 ohms (Type 77U).

Part No. 099 0413 00 (Type 77U) \$40.00



**REDUCER CONNECTOR** — Provides for direct attachment of 1 $\frac{5}{8}$ " Heliac to antennas with  $\frac{7}{8}$ " EIA flange. 50 ohms (Type 77S).

Part No. 099 0236 00 \$50.00

**MITER ELBOW** — Has swivel flanges at each end, includes "O" ring gasket, inner connector and hardware. 50 ohms (Type 1061) or 75 ohms (Type 1071).

Part No. 099 0414 00 (Type 1061) \$48.00  
Part No. 099 0415 00 (Type 1071) \$48.00

**INNER CONNECTOR** — Used to join 1 $\frac{5}{8}$ " EIA flanges. 50 ohms (Type 15069) or 75 ohms (Type 24259).

Part No. 097 6219 00 (Type 15069) \$8.00  
Part No. 099 0418 00 (Type 24259) \$8.00

**INNER ADAPTER** — Used to connect 1 $\frac{5}{8}$ " EIA flanges to 51.5 ohm flat flange (Type 4851).

Part No. 097 5447 00 \$10.00

**GROUNDING KIT** — Provides a positive ground connection to grounded tower (Type 24811).

Part No. 099 0419 00 \$3.00

**HOISTING KIT** — Used for hoisting cable or pulling through conduit. May be used as top anchor of tower installation (Type 24312).

Part No. 099 0420 00 \$12.00

**INSULATED HANGER** — Used at five foot intervals (Type 24622).

Part No. 099 0124 00 \$8.00

**WRAPLOCK** — Stainless steel wraplock used to attach cable to tower at five foot intervals (Type 12395-1).

Part No. 097 5010 00 \$12.50

## ANDREW 83A SEMI-FLEXIBLE TRANSMISSION LINE



Recommended for VHF communications, aircraft applications, low power signal measurement and RF distribution systems, the Andrew 83A  $\frac{3}{8}$ " is a small size air dielectric cable with an efficiency comparable to the largest solid dielectric cables. Often preferred in many applications for its small diameter, light weight and ability to withstand high temperatures, the 83A is constructed entirely of copper and ceramic. When installed with its gas-tight end terminals and maintained under dry air pressure, it is completely weatherproof and capable of retaining its high efficiency indefinitely. Where weight is important, the outer conductor may be made of aluminum instead of copper.

<i>Type Number:</i>	83A
<i>Characteristic Impedance:</i>	50 ohms
<i>Frequency Range:</i>	0-3110 mc
<i>Velocity:</i>	83.3%
<i>Peak Power Rating:</i>	6 kw
<i>Outer Conductor Diameter:</i>	0.375" O.D.
	0.311" I.D.
<i>Inner Conductor Diameter:</i>	0.114" O.D.
<i>Shipping Weight (per foot):</i>	0.18 lbs.

Part No. 097 5301 \$ .80 per foot



**GAS BARRIER** — For use between pressurized and unpressurized cable sections. 50 ohms (Type 1261B) or 75 ohms (Type 1271).

Part No. 099 0238 00 (Type 1261B) \$60.00  
Part No. 099 0416 00 (Type 1271) \$60.00

**END TERMINAL** — Mates to 1 $\frac{5}{8}$ " flange. For use below 174 mc. 50 ohms (Type 2061) or 75 ohms (Type 2071).

Part No. 097 7042 00 (Type 2061) \$50.00  
Part No. 099 0417 00 (Type 2071) \$50.00



## TRANSMISSION LINES

### ANDREW 83A SEMI-FLEXIBLE TRANSMISSION LINE ACCESSORIES

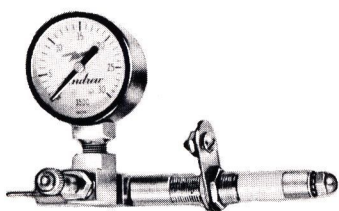

1701AGV

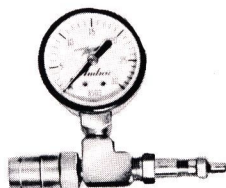

990GV

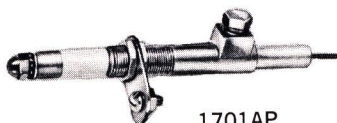

1701AP



8319A



1701AR

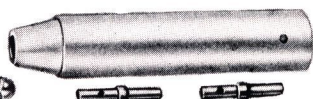

8329A



6102

**END TERMINAL** — Includes gas inlet and pressure gauge with inner and outer connectors (Type 1701AGV).

Part No. 099 0421 00 \$12.00

**END TERMINAL** — With removable exhaust plug and includes connectors (Type 1701AP).

Part No. 097 5309 00 \$8.00

**END TERMINAL** — With needle valve for gas release and includes connectors (Type 1701AR).

Part No. 099 0422 00 \$10.00

**CABLE CAP** — Includes pressure gauge and gas inlet valve (Type 990GV).

Part No. 099 0423 00 \$4.00

**CONNECTOR** — For joining two sections of cable and includes inner connectors (Type 8319A).

Part No. 097 6296 00 \$1.00

**ADAPTER** — Has Type UHF jack on one end. Other end attaches to 1701AGV or equivalent (Type 4868).

Part No. 097 5788 00 \$8.75

**ADAPTER** — For connecting to 7/8" cable (Types S450 or 737 cable) and includes inner connectors (Type 8329A).

Part No. 099 0424 00 \$10.00

**MOUNTING STRAP** — Used to attach line to wood support (Type 6102).

Part No. 099 0425 00 \$ .10

### ANDREW 740 SEMI-FLEXIBLE TRANSMISSION LINE

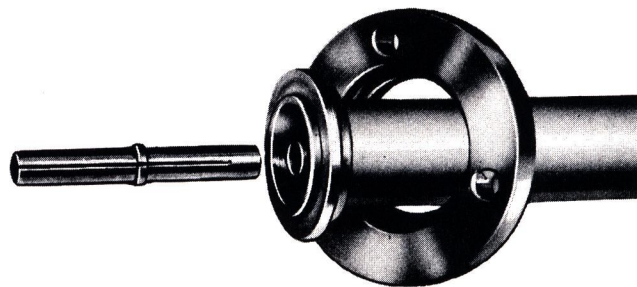

The 740 7/8" Andrew semi-flexible cable has a very high efficiency as compared to solid dielectric cables of similar size. The line is also an excellent choice for directional AM broadcast arrays. Inner and outer conductors are of soft temper copper tubing. The line is manufactured in 100' lengths which are factory spliced to form continuous lengths up to 1,000'. The inner conductor is supported by low loss steatite insulators. Type 740 has 7/8" flat flanges attached and is shipped under pressure. Each length includes end cover caps and a gauge and valve assembly. Specify cable caps or end fittings desired. Type S450 is designed for use with solder type connectors. It is unflanged and available with end terminals attached.

<i>Type Number:</i>	740
<i>Characteristic Impedance:</i>	50 ohms
<i>Frequency Range:</i>	0-780 mc
<i>Velocity:</i>	87.2%
<i>Power Rating:</i>	
<i>AM Broadcast</i>	3.2 kw with VSWR = 3
<i>FM at 108 mc</i>	2.3 kw with VSWR = 1.75
<i>Communications at 174 mc</i>	2.1 kw with VSWR = 1.5
<i>Outer Conductor Diameter:</i>	0.875" O.D. 0.795" I.D.
<i>Inner Conductor Diameter:</i>	0.313" O.D. 0.263" I.D.
<i>Shipping Weight (per foot):</i>	0.50 lbs.

Part No. 099 0187	(Type 740)	\$15.00 per length plus \$1.35 per foot
Part No. 097 5610	(Type S450)	\$1.35 per foot

### ANDREW 740 SEMI-FLEXIBLE TRANSMISSION LINE ACCESSORIES

**ADAPTER** — Has Type UHF jack for RG-8/U cable; other end has 7/8" flange for connection to Type 740. Teflon insulated for use to 470 mc. Includes hardware. Use 10805-13 plug (Type 4855).

Part No. 097 6611 00 \$11.00

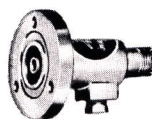

4855

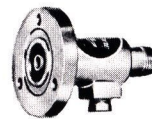

12291A

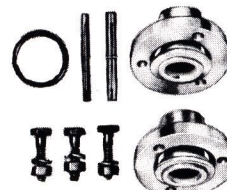

13223A-1

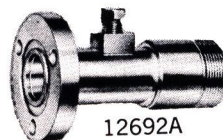

12692A



**ADAPTER** — Has Type N jack for RG-8/U; other end has 7/8" flange for connection to Type 740 line. Includes connecting hardware (Type 12291A).

Part No. 099 0426 00 \$11.00

**SWIVEL FLANGES** — Pair of swivel flanges includes inner connector and hardware (Type 13223A-1). Spare swivel flange (Type 13223A-2) includes inner connector and hardware.

Part No. 099 0075 00 (Type 13223A-1) \$9.75  
Part No. 097 7580 00 (Type 13223A-2) \$6.00

**ADAPTER** — To Type LC plug (Type 12692A).

Part No. 097 6884 00 \$28.00

## ANDREW S450 SEMI-FLEXIBLE TRANSMISSION LINE ACCESSORIES

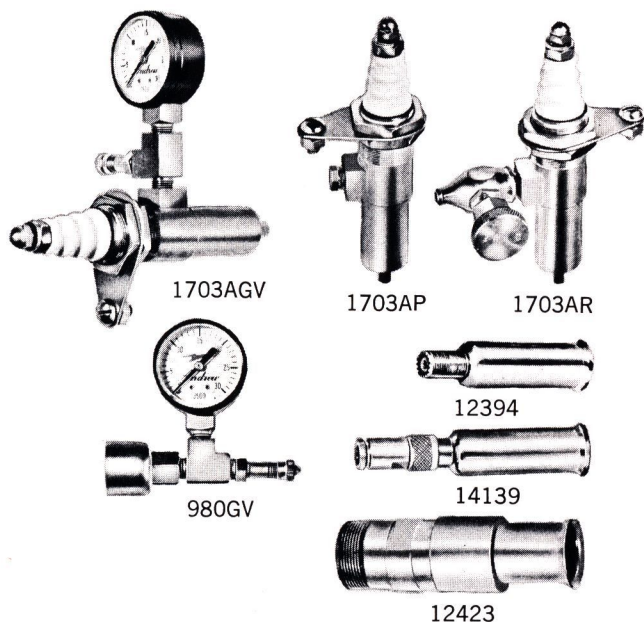

**END TERMINAL** — Includes gauge, valve and connectors (Type 1703AGV).

Part No. 097 7550 00 \$16.00

**END TERMINAL** — Includes gas release plug and connectors (Type 1703AP).

Part No. 097 4937 00 \$11.00

**END TERMINAL** — Includes release valve and connectors (Type 1703AR).

Part No. 097 4938 00 \$14.00

**CABLE CAP** — Includes gauge and valve (Type 980GV).

Part No. 099 0427 00 \$6.00

**ADAPTER** — Has Type UHF jack, attaches to end terminal (Type 12394).

Part No. 099 0428 00 \$7.00

**ADAPTER** — Has Type N jack, attaches to end terminal on S450, includes Type N plug (Type 14139).

Part No. 099 0429 00 \$8.00

**ADAPTER** — Has LC jack, attaches to end terminal on S450 (Type 12423).

Part No. 099 0430 00 \$17.50

## ANDREW 560 RIGID TRANSMISSION LINE

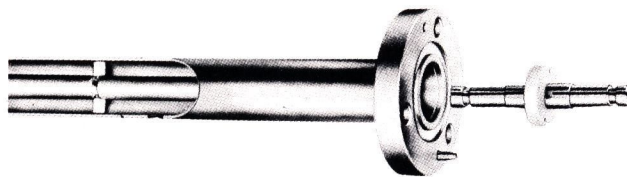

Ideally suited for transmitter room interconnections, the Andrew 560 7/8" is a high efficiency line with Teflon insulators that support the inner conductor and afford extremely low loss. Constant impedance throughout the length of the line is insured by undercutting the inner conductor at the insulators. An EIA anchor insulator connector at each flange supports the inner conductor weight in vertical runs. 560 is supplied in standard 20' sections. Each section includes EIA connector, "O" ring gasket and hardware. Special lengths are available by specifying Type 2760 and length in inches.

Type Number:	560
Characteristic Impedance:	50 ohms
Frequency Range:	0-3000 mc
Velocity:	99.8%
Peak Power Rating:	43 kw
VSWR (100' with matched load max. to upper frequency limit):	1.25
Outer Conductor Diameter:	0.875" O. D. 0.785" I. D.
Inner Conductor Diameter:	0.341" O. D. 0.291" I. D.
Shipping Weight — (12 sections per crate):	400 lbs.
Shipping Dimensions:	14" x 13" x 245"
Part No. 099 0432	\$72.00 per section

## ANDREW 560 RIGID TRANSMISSION LINE ACCESSORIES

Each of the following fittings includes "O" ring gasket, inner connector and hardware.

**ELBOW** — VSWR less than 1.03 up to 2400 mc (Type 1060).

Part No. 099 0202 00 \$30.00

**GAS BARRIER** — VSWR is less than 1.03 up to 2600 mc (Type 1260A).

Part No. 099 0203 00 \$32.00

**SOFT SOLDER FIELD FLANGE KIT** — Consists of sleeves with fixed ring and sliding ring (Type 1560A).

Part No. 099 0433 00 \$9.00

**ADAPTER** — Mates with Type N plug. VSWR is less than 1.05 up to 1000 mc and 1.15 up to 2700 mc. Gas tight (Type 2260).

Part No. 099 0037 00 \$20.00

**ADAPTER** — Mates with Type LC plug. VSWR is less than 1.05 up to 1000 mc, and 1.09 up to 2900 mc. Gas tight (Type 2360).

Part No. 097 5959 00 \$32.00



## TRANSMISSION LINES

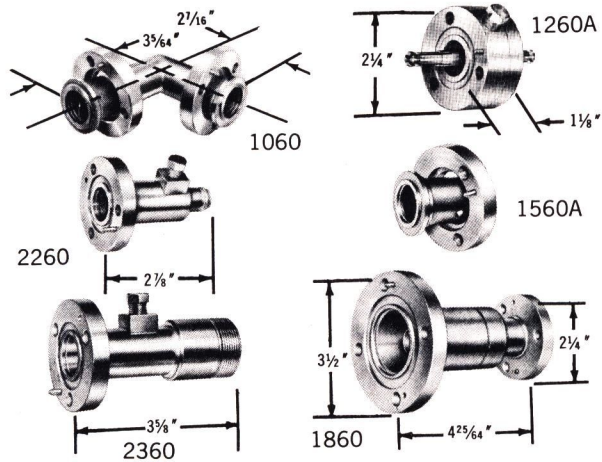

**REDUCER** — Connects Type 560 to Type 561 line. VSWR is less than 1.03 up to 1900 mc. Includes connectors and hardware for both ends (Type 1860).

Part No. 097 5405 00 \$40.00

**INNER CONNECTOR** — VSWR is less than 1.02 to 2800 mc. Shown with 560 line (Type 18275).

Part No. 099 0510 00 \$4.00

**RIGID HANGER** — Used at top of the tower (Type 14328).

Part No. 099 0169 00 \$6.00

**SLIDING HANGER** — Used at six foot intervals (Type 14327).

Part No. 099 0511 00 \$3.00

**SPRING HANGER** — Used at 100' intervals (Type 13889).

Part No. 099 0512 00 \$9.00

**ANGLE ADAPTER** — Attaches 14328, 14327 and 13889 to tower members up to 7/8" thick with no drilling required (Type 13555).

Part No. 097 6124 00 \$3.00

**HORIZONTAL ANCHOR** — Attaches line to enter wall at angles up to 45°. Includes weather-proof cover (Type 3900).

Part No. 099 0513 00 \$18.00

## ANDREW 561 RIGID TRANSMISSION LINE

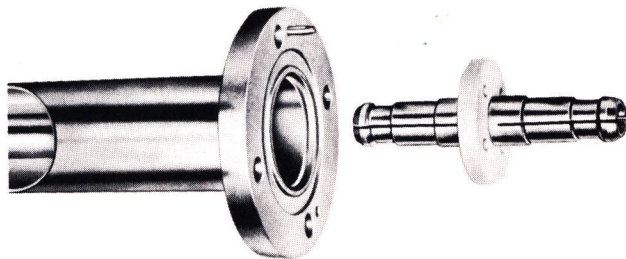

A very low VSWR line that is field proven for transmitter room interconnections, the Andrew 561 1 5/8" Teflon insulated line has compensated inner conductors. Anchor insulator connectors at each flange support the inner conductor on vertical runs and provide for differential expansion. Conductors and con-

nectors are fully compatible with EIA standards. The line is supplied in 20' sections. Special lengths are available by specifying Type 2761 and length in inches. Each section includes inner connector, "O" ring gasket, nuts, bolts and lockwashers. Where weight is important, aluminum lines are available.

<i>Type Number:</i>	561
<i>Characteristic Impedance:</i>	50 ohms
<i>Frequency Range:</i>	0-2700 mc
<i>Velocity:</i>	99.8%
<i>Peak Power Rating:</i>	140 kw
<i>VSWR (100' with matched load max. to upper frequency limit):</i>	1.10
<i>Outer Conductor Diameter:</i>	1.625" O. D. 1.527" I. D.
<i>Inner Conductor Diameter:</i>	0.664" O. D. 0.588" I. D.

<i>Shipping Weight — (6 sections per crate):</i>	290 lbs.
<i>Shipping Dimensions:</i>	12" x 8" x 245"

Part No. 097 7096	(Type 561)	\$90.00 per section
Part No. 097 5966	(Type 2761)	\$30.00 per length plus \$ .35 per inch

## ANDREW 561 RIGID TRANSMISSION LINE ACCESSORIES

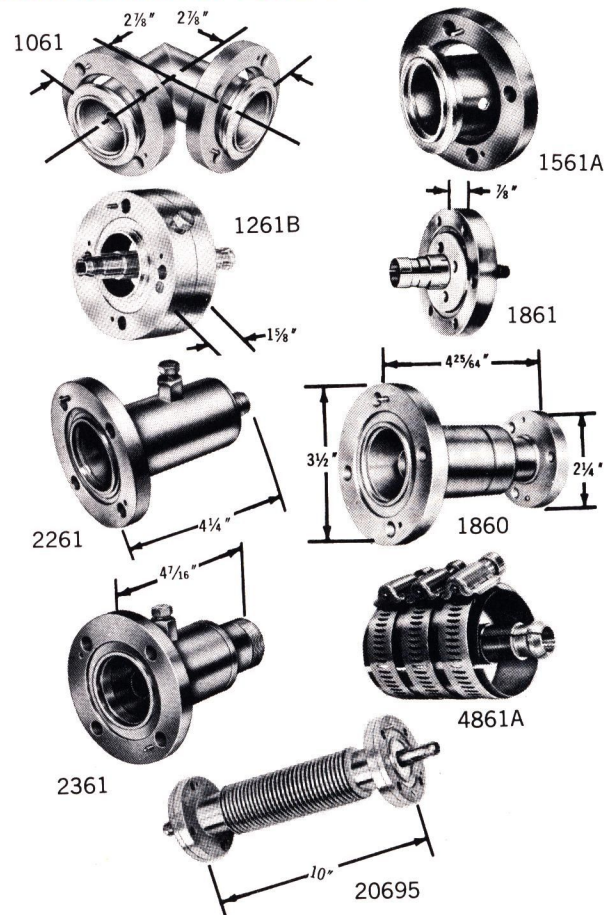

Each of the following fittings includes "O" ring gasket, inner connector and hardware.

**MITER ELBOW** — Has swivel flanges at each end. VSWR is less than 1.04 up to 2800 mc (Type 1061).

Part No. 097 5620 00 \$48.00



**GAS BARRIER** — VSWR is less than 1.05 up to 2800 mc (Type 1261B).

Part No. 099 0238 00 \$60.00

**ADAPTER** — Type N jack, mates with Type N plug (10804-6, not included). VSWR is less than 1.06 up to 3000 mc. Includes gas barrier and gas vent plug (Type 2261).

Part No. 097 7544 00 \$42.00

**ADAPTER** — Type LC jack, mates with Type LC plug (12418-1, not included). VSWR is less than 1.08 up to 2700 mc. Includes gas barrier and removable gas vent plug (Type 2361).

Part No. 097 5527 00 \$58.00

**FLEXIBLE SECTION** — Ten-inch flexible section accommodates vibration and angles up to 30°. Handles 140 kw peak power and pressure to 30 psi. VSWR is less than 1.04 up to 1200 mc and less than 1.1 up to 2.0 kmc. Frequency range 0-2.7 kmc. Maximum offset is 1/4" (Type 20695). Eighteen-inch flexible section is similar to Type 20695. VSWR is less than 1.05 up to 500 mc. Frequency range 0-500 mc. Maximum offset is 3/4" (Type 19170).

Part No. 099 0434 00 (Type 20695) \$140.00

Part No. 099 0435 00 (Type 19170) \$200.00

**SOFT SOLDER FIELD FLANGE KIT** — Consists of sleeves with fixed ring and sliding ring (Type 1561A).

Part No. 097 6351 00 \$18.00

**REDUCER** — Connects Type 561 to Type 562A. Has EIA flanges on both ends. VSWR is less than 1.02 up to 1000 mc (Type 1861).

Part No. 097 6050 00 \$75.00

**REDUCER** — Attaches 561 to 560. VSWR is less than 1.03 up to 1900 mc. Includes connectors and hardware for both ends (Type 1860).

Part No. 099 0436 00 \$40.00

**UNPRESSURIZED STRAIGHT COUPLING** — Connects unflanged sections of Type 561. Includes inner connector and clamps (Type 4861A).

Part No. 099 0437 00 \$8.00

**RIGID HANGER** — Attaches at top of tower. Use two if tower is over 300' high (Type 13924).

Part No. 097 5969 00 \$8.00

**SLIDING HANGER** — Used at 10' intervals to prevent lateral motion of line (Type 14378).

Part No. 097 5972 00 \$6.00

**SPRING HANGER** — Has brass housing, stainless steel spring and clamp. Use at 50' intervals. Accommodates expansion of the line (Type 14379).

Part No. 097 5970 00 \$12.00

**ROUND MEMBER CLAMP** — Galvanized iron clamp attaches hanger to tower members up to 3" in diameter. Order one per hanger (Type 13550).

Part No. 097 6745 00 \$4.00

**LATERAL BRACE** — Used at the bottom of vertical runs to prevent lateral motion while accommodating expansion. Includes rubber cushion and end fittings for 1/2" thin wall conduit (Type 3921).

Part No. 097 7277 00 \$18.00

**HORIZONTAL HANGER** — For horizontal mounting, permits axial movement (Type 3911).

Part No. 097 7535 00 \$12.00

**HORIZONTAL ANCHOR** — Attaches line to enter building wall at angles up to 45°. Includes weather-proof cover (Type 3901).

Part No. 097 5968 00 \$25.00

**GROUNDING CLAMP** — For grounding insulated line to tower (Type 12430).

Part No. 099 0509 00 \$8.00

**EXTENSION SPACER** — Used with noninsulated line hangers to space them the same distance from tower as insulated hangers (Type 13552).

Part No. 097 6744 00 \$3.00

**ANGLE ADAPTER** — Galvanized clamp which attaches hanger to tower angle members up to 7/8" thick without drilling. Order one per hanger (Type 13555).

Part No. 097 6124 00 \$3.00

## ANDREW 562A RIGID TRANSMISSION LINE

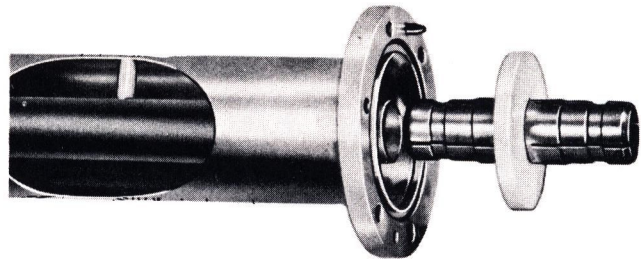

A Teflon insulated line, the Andrew 562A 3 1/8" is a versatile low VSWR line fully compatible with EIA standards. Inner conductor connectors use an Andrew designed piston ring spring to insure uniform and positive contact. The line is supplied in 20' sections. Special lengths are available by specifying Type 2762A and length in inches. Each section includes inner connector, "O" ring gasket, nuts, bolts and lockwashers. Where weight is important, aluminum construction is available.

Type Number:	562A
Characteristic Impedance:	50 ohms
Frequency Range:	0-1600 mc
Velocity:	99.8%
Peak Power Rating:	400 kw
VSWR (100' with matched load max. to upper frequency limit):	1.05
Outer Conductor Diameter:	3.125" O. D. 3.027" I. D.
Inner Conductor Diameter:	1.315" O. D. 1.231" I. D.
Shipping Weight — (4 sections per crate):	425 lbs.
Shipping Dimensions:	13" x 14" x 245"

Part No. 097 7283 (Type 562A) \$140.00 per section

Part No. 099 0438 (Type 2762A) \$50.00 per length plus \$ .50 per inch



# TRANSMISSION LINES

## ANDREW 562A RIGID TRANSMISSION LINE ACCESSORIES

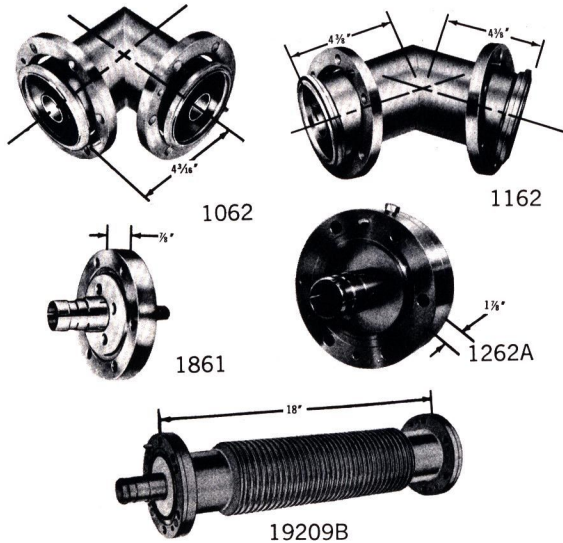

Each of the following fittings includes "O" ring gasket, inner connector and hardware.

**MITER ELBOW** — Has EIA swivel flanges at each end. VSWR is less than 1.02 up to 1000 mc. Outer conductor is extra heavy brass (Type 1062).

Part No. 097 5621 00 \$80.00

**MITER ELBOW** — Similar to 1062 except without flanges, for use with Type 4862A coupling (Type 1062-2).

Part No. 099 0439 00 \$40.00

**45° MITER ELBOW** — Has same construction as 1062. VSWR is less than 1.02 up to 1000 mc (Type 1162).

Part No. 099 0440 00 \$90.00

**REDUCER** — Connects Type 562A to Type 561, 1 5/8" line. Mates with EIA standard flanges at both ends. VSWR is less than 1.02 up to 1000 mc (Type 1861).

Part No. 097 6050 00 \$60.00

**GAS BARRIER** — Includes inlets on both sides. Connects pressurized section to unpressurized section. VSWR is less than 1.02 up to 1600 mc (Type 1262A).

Part No. 097 5754 00 \$75.00

**FLEXIBLE SECTION** — Accommodates vibration between equipments. Suitable for high voltage systems. Frequency range is 0-1600 mc. Maximum offset is 1/2"; maximum stretch or compression, 1/4". Maximum pressure is 30 psi; maximum VSWR is less than 1.05 up to 1200 mc. Can form angles up to 30°. Includes connectors for each end. Do not use for expansion (Type 19209B).

Part No. 099 0441 00 \$300.00

**BREAKAWAY SECTION** — Permits easy opening of transmission line run. Impedance is 50 ohms, and VSWR is under 1.025 up to 1100 mc. Outer conductor bolts into place when extended and is pressure tight (Type 2962).

Part No. 099 0442 00 \$200.00

**MALE TO MALE ADAPTER** — Certain components such as flexible sections, breakaway sections and flexible cable end fittings include built-in inner connectors. This unit connects between such devices (Type 23187).

Part No. 097 7262 00 \$20.00

**UNGASSED COUPLING** — Connects sections of unflanged 562A line (Type 4862A).

Part No. 099 0443 00 \$24.00

**END TERMINAL** — For low frequency application (Type 2062).

Part No. 099 0444 00 \$60.00

**ADAPTER** — Mates with Type N plug (10804-6). VSWR is less than 1.02 up to 1000 mc (Type 2262).

Part No. 099 0445 00 \$80.00

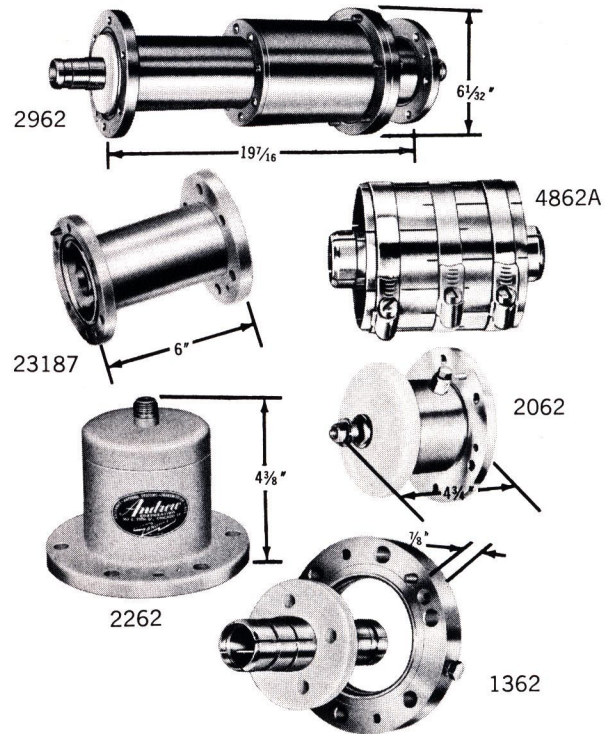

**GAS INLET COUPLING** — Has 1/8" inlets with pipe plugs. Includes special inner connector (Type 1362).

Part No. 099 0446 00 \$45.00

**RIGID HANGER** — Used at the top of the tower. Use two if tower is more than 300' high (Type 13927).

Part No. 097 7018 00 \$14.00

**GROUNDING CLAMP** — Grounds insulated line to tower. Includes flexible ground connection (Type 12431).

Part No. 099 0503 00 \$12.00

**SPRING HANGER** — Attached at 10' intervals to support weight and accommodate differential expansion of line (Type 13925).

Part No. 097 6122 00 \$18.00

**INSULATED SPRING HANGER** — Similar to 13925 except includes 14063 insulator and hardware (Type 13926).

Part No. 097 6768 00 \$26.00



**LATERAL BRACE** — Used at the bottom of vertical runs to prevent lateral motion of line while accommodating expansion and contraction. Includes rubber cushion connectors and end fittings for use with 1/2" thin wall conduit (Type 3922).

Part No. 099 0504 00 \$18.00

**HORIZONTAL HANGER** — Permits axial movement caused by expansion and contraction (Type 3912).

Part No. 099 0505 00 \$15.00

**HORIZONTAL ANCHOR** — Attaches horizontal runs to building wall at any angle up to 45°. Includes a weatherproof cover (Type 3902).

Part No. 099 0506 00 \$40.00

**EXTENSION SPACER** — Used with non-insulated spring hangers to space them the same distance from the tower as insulated hangers (Type 13552).

Part No. 099 0507 00 \$2.00

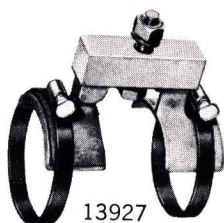

13927

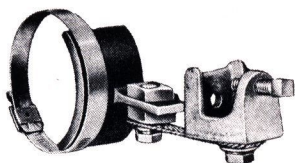

12431

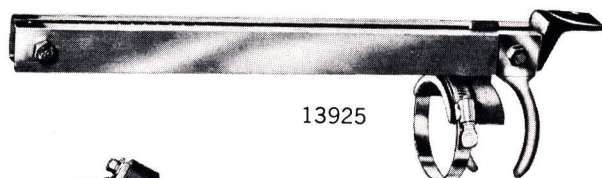

13925



3922

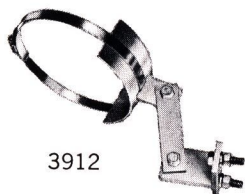

3912

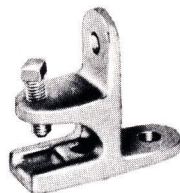

13555



13552

**ANGLE ADAPTER CLAMP** — Galvanized iron clamp which attaches hanger to tower having angle members up to 7/8" thick (Type 13555).

Part No. 097 6124 00 \$3.00

**ROUND MEMBER CLAMP** — Galvanized iron and attaches hanger to tower having round members 3/4" to 3" in diameter (Type 13550).

Part No. 097 6745 00 \$4.00

**INSULATOR** — For use with 3 1/8" 562A rigid transmission line (Type 14063).

Part No. 097 6746 00 \$6.50

## ANDREW 1910A AUTOMATIC DEHYDRATOR

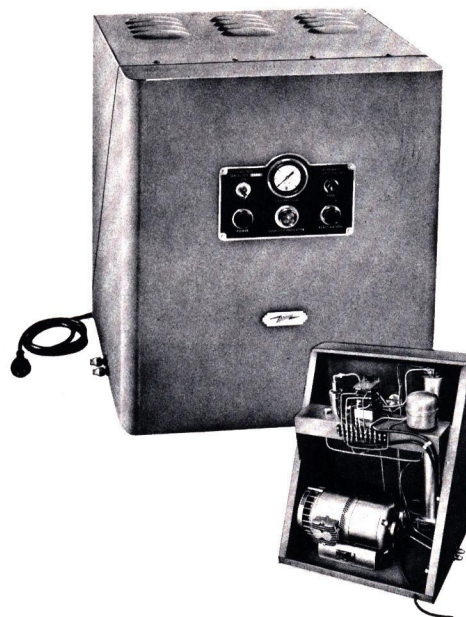

A piston type compressor unit that provides dry air for pressurization of air dielectric coaxial transmission line, the 1910A uses carbon rings to assure oil-free dry air and years of maintenance-free service. The compressor unit is driven by a heavy duty 1/4 hp motor.

The 1910A automatic dehydrator maintains a constant dry air pressure in the line of 5 psi. A special dehydrator is available with dual outputs of 22-30 psi and constant 5 psi. The 30 psi side acts as a reservoir for the 5 psi side. For normal applications, 5 psi is adequate.

A solenoid operated valve prevents line pressure leak back. Line pressure and condition of desiccant are indicated on the front panel. A heater reactivates the desiccant every four hours of compressor operating time. Complete reactivation is accomplished in two hours while the valve holds the pressure in the line. In an average system, reactivation will occur only once in several weeks.

*Compressor Output:* 1.4 cu. ft. per minute at 10 psi. *Output Connection:* Flare fitting for 1/4" tubing; 20 ft. of tubing included. *Power Consumption:* 380 watts by compressor; 1,250 watts during first hour of reactivation. *Power Source Required:* 115 v, 60 cps (standard); 115 v, 50 cps (on special order). *Dehydrator Capacity:* 7/8" line diameter, 40,000'; 1 5/8" line diameter, 10,000'; 3 1/8" line diameter, 2,500'; 6 1/8" line diameter, 700'. *Size:* 21" W, 24" H, 16" D. *Weight:* 135 lbs.

Part No. 097 5624 00

\$450.00

## ANDREW 878 DRY AIR HAND PUMP

The 878 delivers output air of 50°-60° F., dewpoint differential depending upon intake conditions. Pressurizes up to 1,000' of 7/8" cable and up to 250' of 1 5/8" cable. Supplied with 1 lb. of silica gel and 8' of hose. *Weight:* 12 lbs.

Part No. 097 5960 00

\$48.00



## TRANSMISSION LINES

### ANDREW 858 NITROGEN TANK FITTINGS

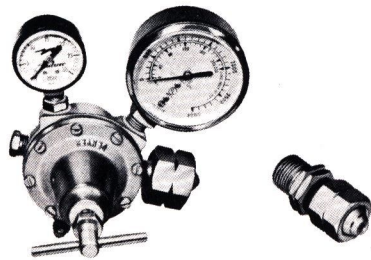

This 858 kit includes a pressure regulator, high and low pressure gauges and 10' of 1/4" O. D. soft temper copper tubing with flare fittings to fit 1/8" pipe threads and adapters to both Air Reduction or Ohio Chemical nitrogen tanks. The nitrogen tanks should be obtained locally.

Part No. 097 7534 00

\$48.00

### AMPHENOL SOLID DIELECTRIC TRANSMISSION LINES



Amphenol coaxial cable center conductors are selected for their mechanical and/or electrical properties. They may be solid or stranded wires. The solid wire results in lowest cable attenuation. Stranding increases cable flexibility but also increases attenuation. Two adjacent braids provide more effective shielding action than one braid, but they are not as effective as two braids separated by a dielectric such as is found in triaxial constructions. Of the jacket types, Type I has good weathering and abrasion properties and can be used for direct burial but is of the contaminating type and will cause cable attenuation to increase with age; and the Type IIa has all of the advantages of the Type I but is non-contaminating. Type II is a gray-polyvinyl chloride jacket.

Type No.	Part No.	Price Per Foot Lengths 1'-499'	Price Per Foot Lengths 500'-999'	Price Per Foot Lengths Over 1,000'
RG 8/U	099 0146	\$ .15	\$ .14	\$ .12
RG 213/U	099 0186	.15	.14	.12
RG 11/U	099 0136	.14	.13	.11
RG 11A/U	099 0447	.15	.14	.12
RG 17/U	099 0137	.72	.66	.57
RG 218/U	099 0249	.76	.70	.60
RG 220/U	099 0077	1.33	1.21	1.04

Type	Impedance	Cap. Mmfd./Ft.	Jacket Type	Over-all Diameter	Weight 100'
RG 8/U	52 ohms	29.5	I	.405"	10.5 lbs.
213/U (Formerly RG 8A/U)	50 ohms	29.5	IIa	.405"	10.3 lbs.
RG 11/U	75 ohms	20.5	I	.405"	9.2 lbs.
RG 11A/U	75 ohms	20.5	IIa	.405"	9.0 lbs.
RG 17/U	52 ohms	29.5	II	.870"	46.3 lbs.
218/U (Formerly RG 17A/U)	50 ohms	29.5	IIa	.870"	46.7 lbs.
220/U (Formerly RG 19A/U)	50 ohms	29.5	IIa	1.120"	—

### PRODELIN 100-815 RIGID 800 TRANSMISSION LINE

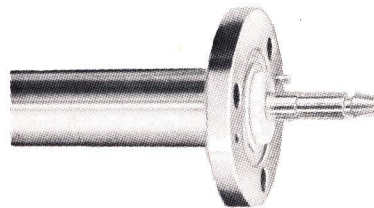

Constructed of high conductivity copper tube, the Prodelin 100-815 7/8" transmission line is manufactured in 20' lengths, flanged at both ends. Includes anchor insulator-connector assembly, "O" ring and hardware.

Type Number:	100-815
Characteristic Impedance:	50 ohms
Peak Test Voltage, 60 cps:	6 kv
Velocity:	99.7%
Outer Conductor Diameter:	.875 O. D.
	.785 I. D.
Inner Conductor Diameter:	.341 O. D.
	.291 I. D.
Shipping Weight — (16 sections per crate):	245 lbs.
Shipping Dimensions:	12" x 12" x 243"

Part No. 099 0452

\$70.00 per section

### PRODELIN 100-815 RIGID 800 TRANSMISSION LINE ACCESSORIES

FLANGE — Fixed flange for silver brazing. Includes silver solder ring insert (Type 300-815).

Part No. 099 0453 00

\$3.00

RING — "O" ring for 7/8" flanges (Type 308-815).

Part No. 099 0454 00

\$ .20

ANCHOR INSULATOR — Connector assembly, silver plated (Type 302-815).

Part No. 099 0455 00

\$4.00

ELBOW ASSEMBLY — Miter, 45°, swivel flanged, male-female. Includes one anchor insulator-connector, "O" ring and hardware (Type 448-815).

Part No. 099 0456 00

\$27.00

ELBOW ASSEMBLY — Miter, 90°, male-female, swivel flanged. Includes one anchor insulator-connector, "O" ring and hardware (Type 494-815).

Part No. 097 7026 00

\$27.00



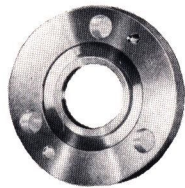

300-815

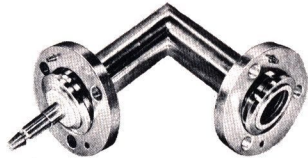

494-815



302-815

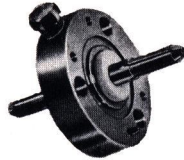

500-815



448-815



505-815

**GAS BARRIER** — Includes "O" ring and extra long hardware. Incorporates 1/8" IPS gas inlet port (Type 500-815).

Part No. 097 7025 00 \$25.00

**END SEAL ASSEMBLY** — Flanged with gas inlet port. Includes "O" ring and hardware (Type 505-815).

Part No. 099 0457 00 \$20.00

### PRODELIN 100-825 RIGID 800 TRANSMISSION LINE

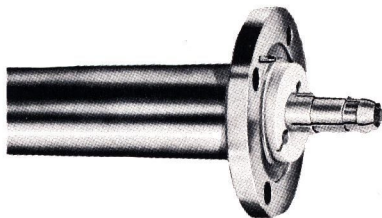

Constructed of high conductivity copper tube, the Prodelin 100-825 1 5/8" transmission line is manufactured in 20' lengths, flanged at both ends. Includes anchor insulator-connector assembly, "O" ring and hardware.

Type Number:	100-825
Characteristic Impedance:	50 ohms
Peak Test Voltage, 60 cps:	11 kv
Velocity:	99.7%
Outer Conductor Diameter:	1.625 O. D.
	1.527 I. D.
Inner Conductor Diameter:	.664 O. D.
	.588 I. D.
Shipping Weight — (8 sections per crate):	280 lbs.
Shipping Dimensions:	12" x 12" x 243"
Part No. 097 7081	\$80.00 per section

### PRODELIN 100-825 RIGID 800 TRANSMISSION LINE ACCESSORIES

**FLANGE** — Fixed flange, 3 1/2" in diameter for silver brazing. Includes silver solder ring insert (Type 300-825).

Part No. 099 0458 00 \$5.00

**RING** — "O" ring gasket for 1 5/8" flanges (Type 308-825).

Part No. 097 7252 00 \$ .25

**ANCHOR INSULATOR** — An insulator-connector assembly, silver plated (Type 302-825).

Part No. 097 7084 00 \$10.00

**CONNECTOR** — Inner conductor connector, silver plated (Type 310-825).

Part No. 099 0459 00 \$7.75

**GAS BARRIER** — Includes "O" ring and 2" long hardware. Incorporates 1/8" IPS gas inlet port (Type 500-825).

Part No. 097 7085 00 \$40.00

**END SEAL** — Assembly, flanged with gas inlet port, includes "O" ring and hardware (Type 505-825).

Part No. 099 0460 00 \$55.00

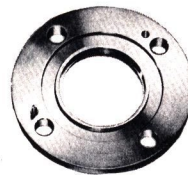

300-825

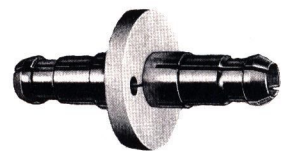

302-825



310-825

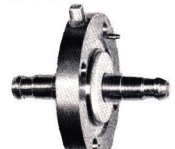

500-825

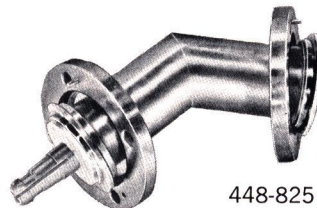

448-825

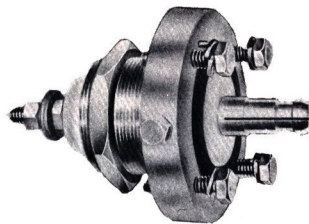

505-825

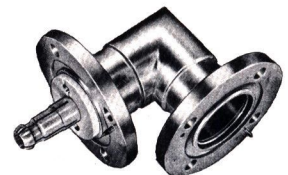

494-825

**ELBOW ASSEMBLY** — Miter, 45°, female, swivel flanged. Includes one anchor insulator-connector, "O" ring and hardware (Type 448-825).

Part No. 097 7511 00 \$40.00

**ELBOW ASSEMBLY** — Miter, 90°, male-female, reinforced, swivel flanged. Includes one affixed male anchor insulator, "O" ring and hardware (Type 494-825).

Part No. 097 6739 00 \$40.00



## TRANSMISSION LINES

### PRODELIN 100-835 RIGID 800 TRANSMISSION LINE

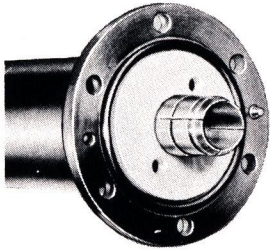

Constructed of high conductivity copper tube, the Prodelin 100-835 3 1/8" transmission line is manufactured in 20' lengths, flanged at both ends. Includes anchor insulator connector assembly, "O" ring and hardware.

Type Number:	100-835
Characteristic Impedance:	50 ohms
Peak Test Voltage, 60 cps:	19 kv
Velocity:	99.7%
Outer Conductor Diameter:	3.125 O. D. 3.027 I. D.
Inner Conductor Diameter:	1.315 O. D. 1.231 I. D.
Shipping Weight — (4 sections per crate):	270 lbs.
Shipping Dimensions:	12" x 12" x 243"
Part No. 097 6631	\$130.00 per section

### PRODELIN 100-835 RIGID 800 TRANSMISSION LINE ACCESSORIES



**FLANGE** — Fixed flange, 5-3/16" in diameter, for silver brazing. Includes silver solder ring insert (Type 300-835).

Part No. 097 6944 00 \$10.00  
44

**RING** — "O" ring gasket for 3 1/8" flanges (Type 308-835).

Part No. 097 6742 00 \$ .40

**CONNECTOR** — Inner conductor connector only, silver plated, spring loaded (Type 310-835). Used with clamp type coupling (Type 305-835).

Part No. 097 6635 00 (Type 310-835) \$10.00  
Part No. 097 6640 00 (Type 305-835) \$9.75

**GAS BARRIER** — Includes "O" ring gasket and 2 1/4" long hardware. Incorporates 1/8" IPS gas inlet port (Type 500-835).

Part No. 097 6945 00 \$75.00

**ELBOW ASSEMBLY** — Sweep, 90°, cast bronze, swivel flanged. Includes affixed male anchor insulator-connectors, "O" ring and hardware (Type 485-835).

Part No. 097 6632 00 \$70.00

**ELBOW ASSEMBLY** — Miter, 90°, male-female, reinforced, swivel flanged. Includes one affixed male anchor insulator-connector, "O" ring and hardware (Type 494-835).

Part No. 097 6986 00 \$68.00

**END SEAL** — Assembly, flanged, with gas inlet port, includes "O" ring gasket and hardware (Type 505-835).

Part No. 099 0461 00 \$90.00

### PRODELIN SPIR-O-LINE SEMI-FLEXIBLE TRANSMISSION LINE

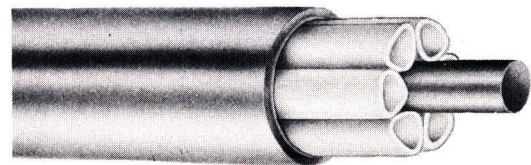

Jacketed Type	Unjacketed Type	Size	Impedance	Weight 1,000' Jacketed	Weight 1,000' Unjacketed
259/U	260/U	3/8"	50 ohms	140 lbs.	100 lbs.
252/U	253/U	1/2"	50 ohms	225 lbs.	175 lbs.
255/U	254/U	7/8"	50 ohms	655 lbs.	555 lbs.
257/U	258/U	1 5/8"	50 ohms	1,380 lbs.	1,200 lbs.

A semi-flexible, aluminum sheathed air dielectric coaxial cable, the Spir-O-line has excellent broadband characteristics and is usable for a wide variety of operating services. Low attenuation is made possible by a unique cable design using intimate six-point tangential contact with compressed dielectric tubes formed about the inner conductor. Spir-O-line is highly crush resistant. The high-conductivity aluminum sheath has excellent corrosion resistance; however, a Spir-O-line cable with a non-contaminating polyethylene jacket is available for use in salt atmosphere, direct burial, under water or in other reactive atmospheres. Spir-O-



line is shipped in exact lengths required with cable ends factory sealed before shipment.

Type	Part No.	Price Per Foot Less Than 1,000'	Price Per Foot Per 1,000' Reels	Reel Charge
259/U	099 0448	\$ .90	\$ .56	\$ 30.00
252/U	099 0449	1.00	.65	70.00
255/U	099 0450	1.70	1.15	110.00
257/U	097 7078	3.80	2.54	190.00
260/U	099 0451	.80	.53	30.00
253/U	097 7023	.90	.60	70.00
254/U	097 7527	1.50	1.02	110.00
258/U	097 8131	3.40	2.28	190.00

Standard reels are 1,000' (plus or minus 10%). Reels are extra but returnable for credit within a period of one year. All reels should be returned freight prepaid directly to Prodelin Inc., 307 Bergen Ave., Kearny, N.J.

## PRODELIN SPIR-O-LINE SEMI-FLEXIBLE TRANSMISSION LINE ACCESSORIES

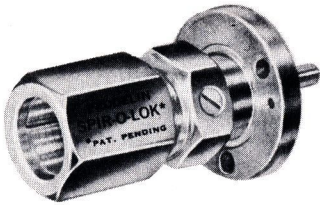

81-875

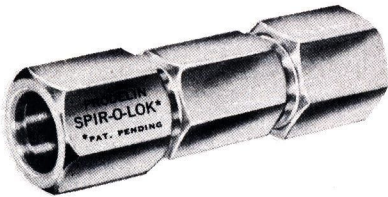

79-375

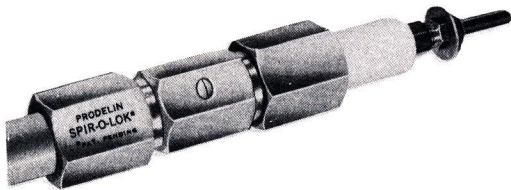

95-375

**ADAPTERS** — 50 ohm adapters for use with Spir-O-line to EIA (RETMA).

Type No.	Cable Size	Part No.	Price
81-875	7/8" to 7/8"	097 7529 00	\$ 16.00
81-1625	1 5/8" to 1 5/8"	097 7079 00	40.00
82-500	1/2" to 7/8"	099 0484 00	15.00
82-875	7/8" to 1 5/8"	097 7528 00	50.00
82-1625	1 5/8" to 3 1/8"	099 0485 00	100.00
85-500	1/2" to 7/8" (Female)	099 0486 00	14.00
85-875	7/8" to 7/8" (Female)	099 0487 00	18.00
85-1625	1 5/8" to 7/8"	097 7080 00	50.00
124-1625	1 5/8" to 1 5/8" (Female)	099 0488 00	60.00

**COUPLINGS** — 50 ohm couplings for Spir-O-line.

Type No.	Cable Size	Part No.	Price
79-375	3/8"	099 0489 00	\$ 10.00
79-500	1/2"	099 0490 00	10.00
79-875	7/8"	099 0116 00	12.00
79-1625	1 5/8"	099 0491 00	60.00

**END SEALS** — 50 ohm end seals for Spir-O-line.

Type No.	Cable Size	Part No.	Price
95-375	3/8"	099 0492 00	\$ 18.00
95-500	1/2"	099 0493 00	18.00
95-875	7/8"	099 0494 00	20.00
95-1625	1 5/8"	097 8132 00	60.00

**WRAPLOCK** — Stainless steel wraplock, 1/2" wide on 100' spool, used for attaching Spir-O-line cable to tower supporting members (Type 20-150).

Part No. 099 0501 00

\$12.00



**DEHYDRATOR** — Hand pump consists of blue indicating gel, and will pressurize up to 1,000' of 7/8" or 250' of 1 5/8" Spir-O-line (Type 30-150).

Part No. 099 0517 00

\$43.00

## JOHNSON FEED-THRU BOWL INSULATORS

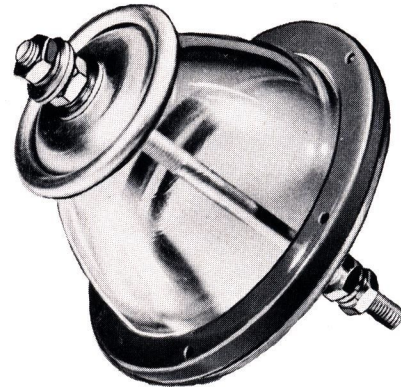

Designed to carry RF transmission line through a wall. Complete assembly includes heavy electrical glass feed-thru bowls, cork gasket and steel mounting flange with six 3/16" mounting holes. Bowl is 6-5/16" maximum diameter and 4 3/8" high. Mounting flange has 7 3/8" diameter. Fittings include spun aluminum corona shield, 1/2"-13 threaded stud (except 135-15-4 which has 5/8"-18 threaded stud, hollow), washers and nuts.

135-15-1 — One bowl and fittings, 10 1/4" stud.

135-15-3 — Two bowls and fittings, 16" stud for walls up to 4" thick.

135-15-7 — Two bowls and fittings, 24" stud for walls up to 12" thick.

Part No. 097 1501 00	(Type 135-15-1)	\$15.40
Part No. 097 6673 00	(Type 135-15-3)	\$27.10
Part No. 097 5646 00	(Type 135-15-7)	\$27.60



# MONITORING & TEST



## HEWLETT-PACKARD 335BR FM MONITOR

Continuous indication of broadcast frequency and of modulation level at all times is provided by the 335BR FM Monitor. It is not necessary to reset the carrier level or re-align circuits because the monitor does not depend upon a tuned circuit. It is specifically designed to be operated without adjustment week after week. The unit has FCC type approval, and it includes provision for operation of a remote modulation meter and remote peak modulation indicator lamp.

*Frequency Range:* 88-108 mc. Supplied with crystal to match frequency of transmitter. *Deviation Range:*  $\pm 3$  kc. *Accuracy:* Better than  $\pm 1000$  cps ( $\pm 0.001\%$ ). *RF Power Required:* 2 watts. *Peak Limit Range:* 50-

120% modulation (75 kc = 100%). Provision for external peak limit indicators.

*Audio Output Frequency Range:* 20 cps to 20 kc. Response flat within  $\pm 0.5$  db. *Distortion:* Less than 0.25% at 100% modulation. *Output Voltage:* 10 volts into 20,000 ohms, at low frequencies. *Noise:* At least 75 db below audio output level resulting from 100% modulation at low frequencies. *Monitoring Output:* 4.0 mw into 600 ohms, balanced, at 100% modulation at low frequencies. *Power:* 115 v  $\pm 10$  v, 60 cps, 165 watts. *Size:* 19" W, 10 $\frac{1}{2}$ " H, 14 $\frac{1}{2}$ " D. *Weight:* 45 lbs.

Part No. 097 4911

\$1,550.00



## GENERAL RADIO 1931-B AM MODULATION MONITOR

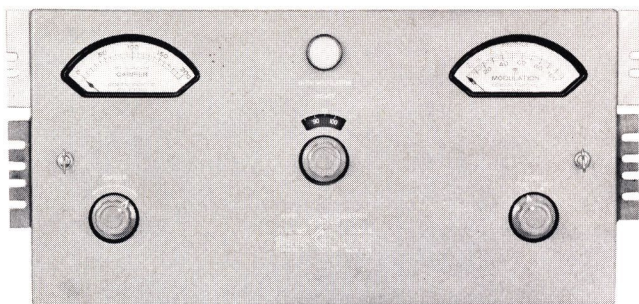

Measures percentage modulation on positive or negative peaks, indicates overmodulation, monitors program level and measures transmitter audio frequency response and carrier shift when modulation is applied. Operates in either 0.5-8 mc range or 3-60 mc range, depending on input coil used. *Primary Power:* 105-125 v, 50/60 cps, 50 watts. *Size:* 19" W, 8 $\frac{3}{4}$ " H, 10" D. *Weight:* 32 lbs.

Part No. 097 5947 00	<b>\$650.00</b>
No Part Number	<b>\$13.43</b>
Spare set of tubes.	
No Part Number	<b>\$8.73</b>
FCC set of spare tubes.	

## GENERAL RADIO 1181-B FREQUENCY DEVIATION MONITOR



Gives direct indications of magnitude and direction of frequency deviation of AM transmitter. Positive indication is provided for failure of either transmitter carrier or monitor crystal oscillator. *Frequency Range:* 0.5-1.6 mc (specify crystal frequency). *Deviation Range:*  $\pm 30$  cps. *Primary Power:* 105-125 or 210-250 v, 50/60 cps, 125 watts. *Size:* 19" W, 15 $\frac{3}{4}$ " H, 13" D. *Weight:* 51 lbs.

Part No. 097 5948	<b>\$1,025.00</b>
No Part Number	<b>\$27.57</b>
Spare set of tubes.	
No Part Number	<b>\$19.39</b>
FCC set of spare tubes.	

## NEMS-CLARK 108 PHASE MONITOR

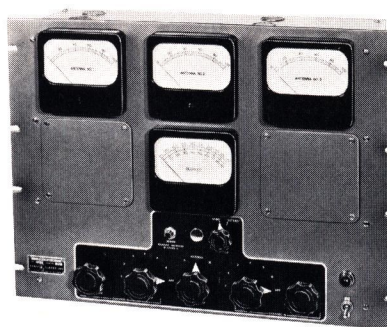

Provides an indication of the phase relations in directional antenna systems, and is tailored for the particular installation. It usually incorporates provision for indicating the relative amplitudes of the currents in the various antennas, as well as the phase relation. Specify requirement for monitoring 2, 3, 4, or over 4 elements.

*Frequency Range:* 100 kc to 2 mc. *Phase Angle Range:* 0° to 360°. *Monitoring Accuracy:* 1°. *Resolution:*  $\frac{1}{2}$ °. *RF Input Impedance:* 50 or 70 ohms nominal. *RF Voltage Range:* 1-7 v. *Tubes:* Two 6AU6, two OB3, one 5Y3 and three 6AL5. *Power Requirements:* 105-125 v, 80 watts. *Size:* 19" W, 14" H, 7" D. *Weight:* 20 lbs.

Part No. 099 0366 00 (2 element)	<b>\$700.00</b>
Part No. 099 0367 00 (3 element)	<b>\$725.00</b>
Part No. 099 0368 00 (4 element)	<b>\$750.00</b>
Part No. 099 0369 00 (over 4 element)	<b>Price on Request</b>

## GENERAL RADIO 1301-A LOW DISTORTION OSCILLATOR



Used as a tone source for distortion measurements and as a power source for bridge measurements at audio frequencies. The 1301-A is also satisfactory for use as a general purpose laboratory oscillator.

*Frequency Range:* 27 fixed frequencies between 20 and 15,000 cps. *Frequency Calibration:* Within  $\pm 1\frac{1}{2}\%$  +0.1 cps. *Frequency Stability:* Not greater than 0.02% per hour after 10 minutes of operation.

*Output Impedance:* 600 ohms balanced to ground; 600 ohms unbalanced; 5,000 ohms unbalanced. *Power Supply:* 105-125 (or 210-250) volts, 25-60 cps (power consumption 45 watts). *Accessories Supplied:* Power cord, multi-point connector and spare fuses. *Size:* 19" W, 7" H, 12" D. *Weight:* 13 $\frac{1}{2}$  lbs.

Part No. 277 0008 00	<b>\$595.00</b>
----------------------	-----------------



## MONITORING & TEST

### GENERAL RADIO 1932-A DISTORTION AND NOISE METER

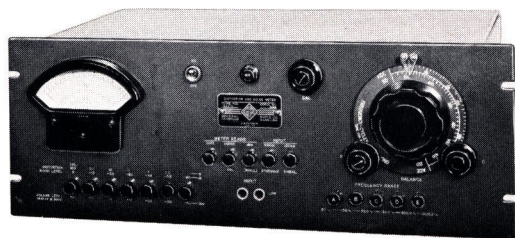

Measures distortion, noise and hum level in audio frequency circuits. In conjunction with the 1931-B Modulation Monitor, the 1932-A can be used to measure these quantities directly in the output of the transmitters.

**Distortion Range:** Full scale deflections for 0.3%, 1%, 3%, 10% or 30% distortion. **Noise Measurement Range:** 80 db below reference calibration level, or 80 db below an AF signal of 0 dbm level at maximum sensitivity. **Audio Frequency Range:** 50-15,000 cps (fundamental) for distortion measurements; 30-45,000 cps for noise and hum measurements. **DBM Range:** Power level range is from +20 to -60 dbm. **Residual Noise Level:** Less than -80 db.

**Input Impedance:** 100,000 ohms unbalanced or 600 ohms bridging input. **Accessories Supplied:** Line cord, cable for connecting to 1931-B, spare fuses. **Power Supply:** 105-125 (or 210-250) volts, 50-60 cps. The line input power is 65 watts. **Size:** 19" W, 7" H, 12" D. **Weight:** 37 $\frac{3}{4}$  lbs.

Part No. 277 0002 00

\$725.00

### BARKER & WILLIAMSON 410 DISTORTION METER

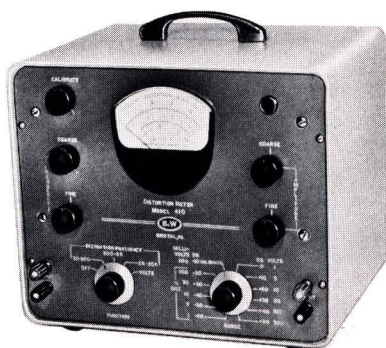

Ideal for FCC proof of performance tests and general laboratory use in measuring audio distortion, noise level and ac voltage level, the B & W 410 operates over a wider frequency range and provides increased sensitivity than earlier models.

The distortion meter measures distortion on fundamental frequencies from 20-20,000 cps and indicates harmonics up to 100,000 cps. Distortion levels as low as 0.1% can be indicated and measurements may be made on signal levels of 0.1-30 v rms. Distortion ranges provided are 1% full scale, 3%, 10%, 30% and 100% (full scale). The unit is designed for optimum accuracy on 600 ohms but is satisfactory on sources up to 100,000 ohms.

48

The 410 voltmeter input impedance is 1 megohm, and it has an accuracy of  $\pm 5\%$  on measurements from 0.0005-300 v. Residual noise is less than 0.02 mv. For noise and db measurements, the unit is calibrated in 1 db steps from 0 db to -15 db. The attenuator provides additional ranges from -60 db to +50 db in 10 db steps.

The chassis, panel and case are of aluminum and attractively styled and finished in two tone gray. **Size:** 11 $\frac{1}{4}$ " W, 9" H, 8" D. **Weight:** 11 lbs.

Part No. 099 0569 00

\$189.50

### BARKER & WILLIAMSON 404 LINEAR DETECTOR

Provides RF detection and audio bridging circuits. For use with any distortion meter. **RF Range:** 400 kc to 30 mc. **Size:** 8 $\frac{3}{4}$ " W, 5" H, 7 $\frac{1}{2}$ " D.

Part No. 097 2208 00

\$105.00

### BARKER & WILLIAMSON 200 AUDIO OSCILLATOR

Resistance capacitance type for making frequency response, distortion and other audio measurements.

**Ranges:** 30-300, 300-3,000, 3,000-30,000 cps. **Output:** 10 v into 500 ohm load. Less than 1% rms harmonics 30-15,000 cps with 500 ohm load. **Response:** Better than  $\pm 1$  db 30-15,000 cps. **Calibration Accuracy:** 3% of scale reading. **Size:** 13 $\frac{3}{4}$ " W, 9 $\frac{1}{2}$ " H, 7 $\frac{1}{4}$ " D. **Shipping Weight:** 17 lbs.

Part No. 097 1186 00

\$138.00

### NEMS-CLARK 120-E FIELD INTENSITY METER

A lightweight instrument for the measurement of a wide range of radio signal intensities.

**Frequency Range:** 540-1600 kc. **Field Intensity Range:** 10 mv/meter to 10 v/meter. **Accuracy of Attenuators:** 2%. **Output Indicator:** Direct reading panel meter. **Antenna:** Shielded, unbalanced loop. **Power Requirements:** Batteries, five 1 $\frac{1}{2}$  v, two 67 $\frac{1}{2}$  v (provisions for external supply). **Size:** 13" W, 9" H, 5 $\frac{3}{4}$ " D. **Weight:** 12 $\frac{1}{2}$  lbs. with batteries.

Part No. 097 5516 00

\$850.00

### NEMS-CLARK 121 ACCESSORY UNIT

Designed as a companion unit to the 120-E (also 120-D, WX-2A, WX-2B, WX-2C and WX-2D). Its principal function is to operate 1 ma recorders of the Esterline Angus type to give a permanent record of field strength. It can also be used as a general purpose recording and monitoring amplifier when a high input impedance is desired and 5 v dc is available.

**Input Required:** Approximately 5 v dc. **Output:** 1 ma into loads up to 2,000 ohms. **Speaker:** 4" panel mounted. **Power Source:** 117 v, 50-60 cps, or 6 v dc. **Power Input:** 15 watts ac or 2.5 amps dc. **Size:** 12 $\frac{1}{2}$ " W, 6 $\frac{1}{2}$ " H, 4 $\frac{1}{2}$ " D. **Weight:** 10 lbs.

Part No. 099 0370 00

\$175.00



# SPEECH INPUT

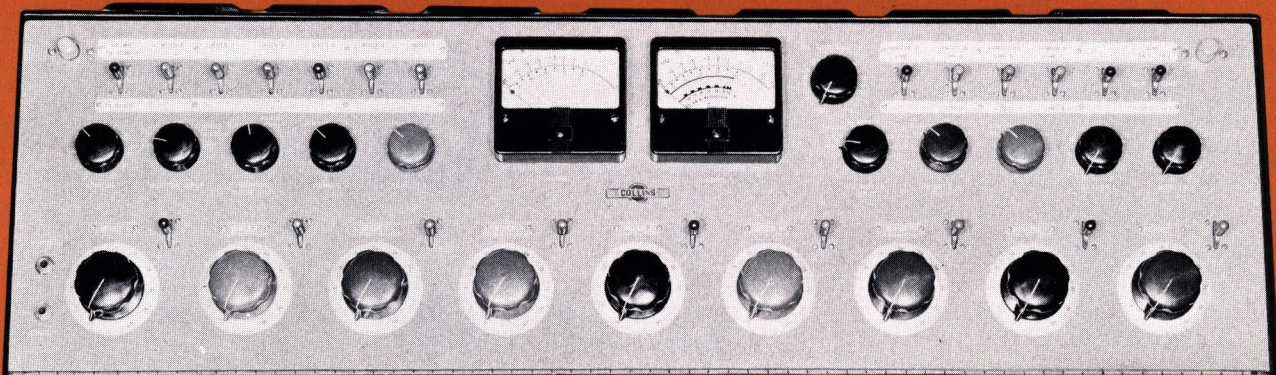

## COLLINS 212E-1 DUAL CHANNEL SPEECH INPUT CONSOLE

The Collins 212E-1 assures broadcasters and recording studios of meeting a wide range of audio mixing requirements. Designed to meet the needs of most complex installations, the 212E-1 also serves equally well for the small, growing audio installation.

Beginning with the modules required for single studio operation, the Collins 212E-1 can be expanded by simply adding plug-in modules to mix 9 of 22 inputs and to provide two program lines and monitor circuits.

The 212E-1 is also adaptable for stereo broadcasting. This is usually achieved by replacing a rotary switch with an additional attenuator which is used as a level control for the additional monitoring channel. The stereo version of the 212E-1 requires an additional 356B-1 Program/Monitor Amplifier. A switch can be provided so that monoaural programming is carried on both channels simultaneously.

Although it has a wide variety of functions and controls, the 212E-1 is easily mastered even by the inexperienced operator. Color coded knobs and switches, in addition to write-in strips for line switches and mixing attenuators, make it possible to vary control functions without confusion to the operator.

Space is provided in the 212E-1 Console cabinet for

seven preamplifiers plus booster, program, monitor and cueing amplifiers. A 499G-1 Rack Mounting Shelf is supplied for the power supply and relay units.

Spare contacts on lever-switches and an unwired lever-switch are included for any desired custom wiring. An external position on the second VU meter input switch can be terminated at a patch panel to provide VU monitoring of external audio circuits. Talk-back on a remote line is simplified to a single switch operation after the initial setup of two switches. Lever-switches permit the selection of two program sources for each low level input fader and selection of four program sources for each remote input fader. The mixer attenuators are Daven step-type, with outputs connected to a key-switch so that each input can be fed to either of the two program channels when the Console is used for dual channel operation. The second channel also can be used for audition purposes during normal single-line program operation. All program, audition and remote lines may be monitored audibly and by VU meter.

Reliability of the 212E-1 has been proven by using carefully engineered, highly stable circuits and the finest quality components. The 212E-1 maintains excellent frequency response and low noise and distortion.



# SPEECH INPUT

**Maximum Number of Channels:** Seven low level channels, two remote channels, two program channels, one monitor channel and one cueing channel when provided with: ten 356A-1 Preamplifiers, two 356B-1 or 356E-1 Amplifiers, one 356B-1 Program/Monitor Amplifier, one 274K-1 Relay Unit, two 409X-2 Power Supplies and two 499G-1 Rack Mounting Shelves.

**Power Source:** 115 v or 230 v ac  $\pm 10\%$ , 50-60 cps, single phase.

**Input Impedance:** Low level — 30/150/250/600 ohms balanced or unbalanced, shipped wired for 150 ohms. Remote lines — 150/600 ohms, shipped wired for 600 ohms.

**Output Impedance:** Line — 150/600 ohms, shipped wired for 600 ohms. Monitor — 600 ohms.

**Input Level:** Low — -50 dbm nominal (100 db gain). Remote — 0 dbm.

**Gain:** Low level to program line 100 db. Remote line

to program line 54 db.

**Output Level:** Program — +18 dbm (65 mw). Monitor — +39 dbm (8 watts).

**Response:**  $\pm 1.5$  db, 50-15,000 cps at program line.

**Distortion:** Less than 1% at +18 dbm at program line. Less than 3% at 8 watts out of Monitor Amplifier.

**Noise:** At least 68 db below +18 dbm output with -50 dbm low level input. (Equivalent input noise level -118 dbm or less.)

**Size:** 41 $\frac{1}{8}$ " W, 11" H, 22 $\frac{1}{2}$ " D.

**Weight:** 135 lbs. (less modules).

**Part No. 522 0773**

**\$2,350.00**

Includes basic cabinet, four 356A-1 Preamplifiers, two 356A-1 Booster Amplifiers, two 356B-1 Program/monitor Amplifiers, one 409X-2 Power Supply and cable, one 274K-1 Relay Unit with necessary plug and cable assembly, one 499G-1 Rack Mounting Shelf, one set of tubes and instruction book.

**No Part Number**

**\$20.43**

FCC set of spare tubes for 212E-1 as listed above.

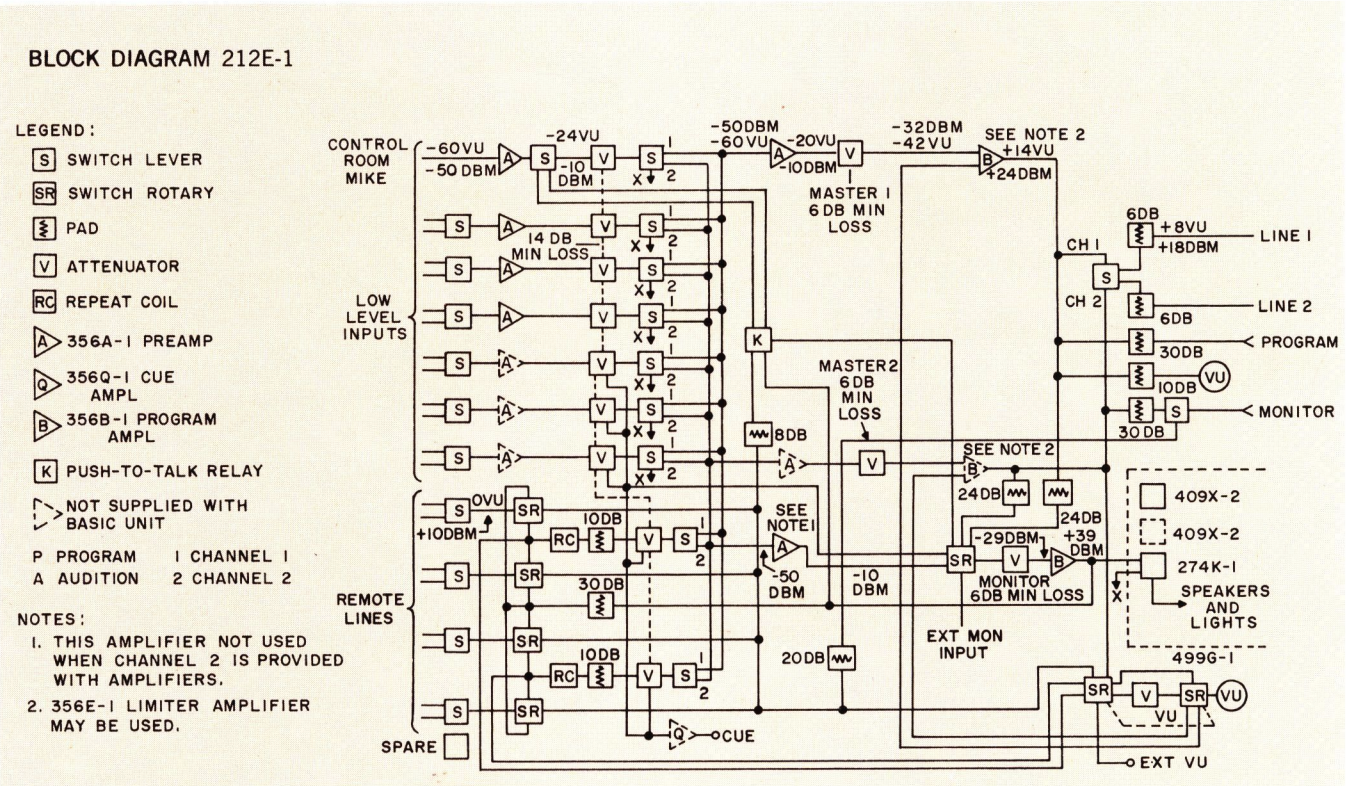

## COLLINS 212G-1 SPEECH INPUT CONSOLE

Incorporating many design and control functions of the 212E-1 and 212F-2 Consoles, the 212G-1 is a flexible, self-contained unit that provides complete control over simultaneous broadcasting and auditioning from any combination of 9 of 13 inputs. The 212G-1 is also an effective console for use in stereo broadcasting but reduces the normal monitoring facilities.

The Collins 212G-1 Console is designed for medium-size radio stations and recording studios which demand a versatile console at production line price. Main features of the 212G-1 are its quality, reliability, ease of

servicing plug-in modules and wide variety of controls.

The long, low design of the 212G-1 assures easy operation on an uncrowded control panel. Finger-fitted knobs with big skirts are easily grasped for exact level control.

The VU meter is centered on the panel directly in front of the operator. The lights are external to the meter and may be replaced without removing the meter face. The meter lights operate from the relay supply voltage giving visual indication of proper operation. A switch allows the VU meter to measure program or



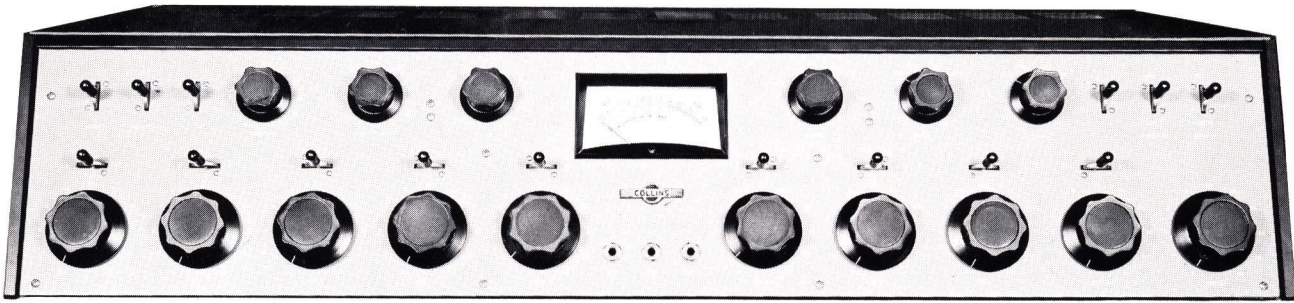

external audio levels and gain reduction when a 356E-1 Limiting Amplifier is substituted for a Collins 356B-1 Program Amplifier.

The 356B-1 Monitor Amplifier input may be switched to program, audition or external inputs. Six cueing-type attenuators, a plug-in cueing amplifier and a cueing speaker free the 212G-1 monitor circuits from cueing service.

The hinged top of the Collins 212G-1 Console provides adequate room to service components while the panel remains in position and the unit is operating. No high voltage points are exposed when the cabinet is opened. A cover protects the terminal wiring strip and connector wiring.

Any of eight circuits may be selected on a terminal strip for control of speakers and warning lights. Extra wiring terminals and two spare lever-switches are provided.

Only two tube types are used in the 212G-1. Slots in the bottom, back and top of the Console provide adequate ventilation for low operating temperatures insuring longer component life.

**Maximum Number of Channels:** Six low level channels, two medium level channels, one net/remote channel, one program channel, one monitor channel and one cueing channel when provided with: eight 356A-1 Preamplifiers, one 356B-1 or 356E-1 Amplifier, one 356B-1 Program/Monitor Amplifier, one 274K-2 Relay Unit, one 356Q-1 Cueing Amplifier and one 409X-2 Power Supply.

**Power Source:** 115 v or 230 v ac  $\pm 10\%$ , 50-60 cps, single phase.

**Input Impedance:** Low level — 30/150/250/600 ohms balanced or unbalanced, shipped wired for 150 ohms. Net/remote lines — 50/150/250/600 ohms, shipped wired for 600 ohms. Medium level — 600 ohms unbalanced.

**Output Impedance:** Line — 150/600 ohms, shipped wired for 600 ohms. Monitor — 600 ohms.

**Input Level:** Low — -50 dbm nominal (100 db gain). Net/remote — 0 dbm. Medium — -10 dbm nominal (60 db gain).

**Gain:** Low level to program line 100 db. Remote line to program line 53 db. Medium level to program line 62 db.

**Output Level:** Program — +18 dbm (65 mw). Monitor — +39 dbm (8 watts).

**Response:**  $\pm 1.5$  db, 50-15,000 cps at program line.

**Distortion:** Less than 1% at +18 dbm at program line. Less than 3% at 8 watts out of Monitor Amplifier.

**Noise:** At least 68 db below +18 dbm output with -50 dbm low level input. (Equivalent input noise level -118 dbm or less.)

**Size:** 41 1/4" W, 8 1/4" H, 21 1/8" D.

**Weight:** 75 lbs. (less modules).

**Part No. 522 1605** **\$1,650.00**  
Includes basic cabinet, five 356A-1 Preamplifiers, two 356B-1 Program/monitor Amplifiers, one 409X-2 Power Supply, one 274K-2 Relay Unit, one set of tubes and instruction book.

**No Part Number** **\$20.43**  
FCC set of spare tubes for 212G-1 as listed above.

### BLOCK DIAGRAM 212G-1

#### LEGEND:

- [S] SWITCH LEVER
- [SR] SWITCH ROTARY
- [Z] PAD
- [V] ATTENUATOR
- [RC] REPEAT COIL
- [A] 356A-1 PREAMP
- [D] 356Q-1 CUE AMPL
- [B] 356B-1 PROGRAM AMPL
- [K] PUSH-TO-TALK RELAY
- [>] NOT SUPPLIED WITH BASIC UNIT
- P PROGRAM
- A AUDITION

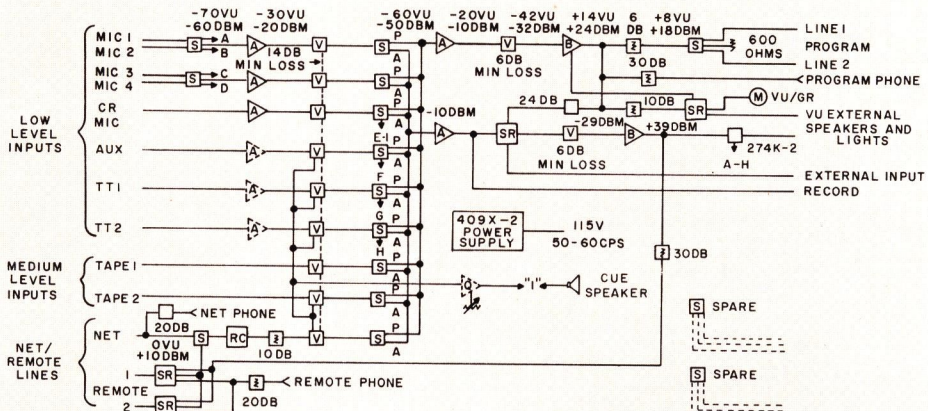



# SPEECH INPUT

## COLLINS 212F-2 SPEECH INPUT CONSOLE

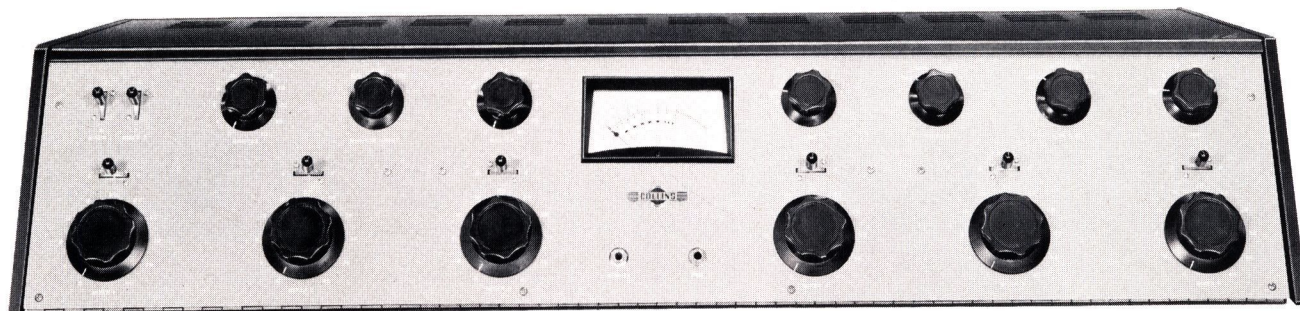

Combining economy and versatility, the Collins 212F-2 makes an outstanding contribution to high fidelity broadcasting or program control in small-size audio systems.

A completely self-contained unit, the 212F-2 provides complete control over simultaneous broadcasting and auditioning from any combination of 6 of 17 possible inputs: 5 of 7 possible low level inputs and a choice of 1 of 10 remote lines.

All plug-in modules have Howard Jones connectors, and an adapter cord is available to permit operation and service of the modules outside the cabinet.

The Collins 212F-2 uses only two types of amplifiers and two tube types, resulting in a minimum maintenance stock of spare tubes.

Three of the mixer attenuators have cueing positions. The output of the cueing circuit operates headphones, or a 356Q-1 Cue Amplifier will provide 100 mw for cue.

Four relays in the 274K-1 Relay Unit may be operated by the lever-switches in the first five input channels. These relays will control the operation of the warning lights and speakers in four studios.

The clean-cut styling of the Collins 212F-2 Speech Input Console makes it an attractive, integral part of any modern control room, and the styling is functional, too. The front panel tilts down and the top cover is hinged across the top of the back to provide quick, easy accessibility for installation, inspection or servicing of amplifiers, power supply, relay unit and wiring.

**Maximum Number of Channels:** Five low level inputs and one remote/net input to a program channel, monitor channel or cueing channel when provided with: seven 356A-1 Preamplifiers, two 356B-1 Program/Monitor Amplifiers (or one 356B-1 Program/Monitor Amplifier and one 356E-1 Limiting Amplifier), one 356Q-1 Cue Amplifier, one 274K-2

Relay Unit and one 409X-2 Power Supply.

**Power Source:** 115 v or 230 v ac  $\pm 10\%$ , 50-60 cps, single phase.

**Input Impedance:** Low level — 30/150/250/600 ohms balanced or unbalanced, shipped wired for 150 ohms. Net/remote — 50/150/250/600 ohms, shipped wired for 600 ohms. Medium level — 600 ohms.

**Output Impedance:** Line — 150/600 ohms, shipped wired for 600 ohms. Monitor — 600 ohms.

**Input Level:** Low — -50 dbm nominal (100 db gain). Net/remote — 0 dbm.

**Gain:** Low level to program line at least 100 db. Remote line to program line 53 db.

**Output Level:** Program — +18 dbm (65 mw). Monitor — +39 dbm (8 watts).

**Response:**  $\pm 1.5$  db, 50-15,000 cps at program line.

**Distortion:** Less than 1% at +18 dbm at program line. Less than 3% at 8 watts out of Monitor Amplifier.

**Noise:** At least 68 dbm below +18 dbm output with -50 dbm input. (Equivalent input noise level -118 dbm or less.)

**Size:** 41-1/16" W, 8-1/4" H, 21-1/8" D.

**Weight:** 67 lbs. (less modules).

**Part No. 522 2608** \$1,295.00  
Includes basic cabinet, three 356A-1 Preamplifiers, two 356B-1 Program/Monitor Amplifiers, one 409X-2 Power Supply, one 274K-2 Relay Unit, one set of tubes and instruction book.

**No Part Number** \$20.43  
FCC set of spare tubes for 212F-2 as listed above.

**Part No. 548 8232 00** \$3.00  
Gain reduction kit.

**Part No. 548 8233 00** \$3.75  
Cue speaker kit.

### BLOCK DIAGRAM 212F-2

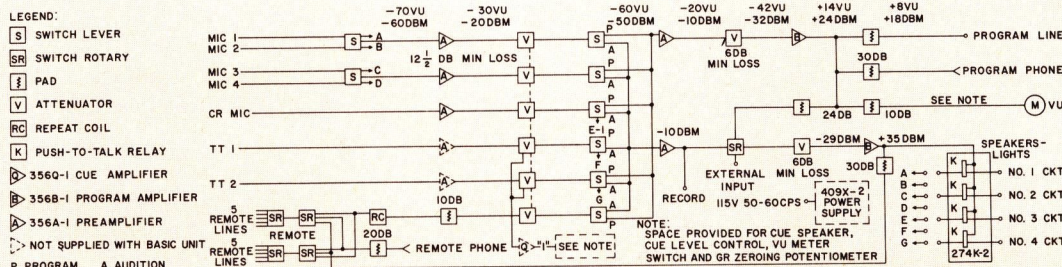



## COLLINS 356A-1 PREAMPLIFIER

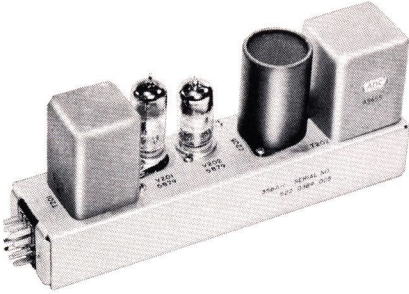

Usually used to feed a line amplifier in the Collins Consoles, the 356A-1 operates from a low level microphone or similar source and has sufficient output to drive a program amplifier or audition facilities.

*Input Impedance:* Unloaded transformer, source impedance 30/150/250/600 ohms balanced or unbalanced, shipped wired for 150 ohms.

*Input Level:* -60 db nominal.

*Output Impedance:* 150/600 ohms balanced or unbalanced, shipped wired for 600 ohms.

*Output Level:* +18 dbm maximum.

*Gain:* 40 db.

*Frequency Response:* ±1 db, 50-15,000 cps.

*Distortion:* 0.5% maximum.

*Noise:* -118 dbm at input, or 96 db below full output.

*Tubes:* Two 5879.

*Power Requirements:* 6.3 v ac or dc at 0.3 amp. 250 v dc at 6.5 ma or 300 v dc at 7.5 ma.

*Size:* 2 1/8" W, 4 5/8" H, 9 1/2" D.

*Weight:* 2 1/4 lbs.

Part No. 522 0389 005  
No Part Number  
100% spare tube kit.

\$68.00  
\$3.50

## COLLINS 356B-1 PROGRAM/MONITOR AMPLIFIER

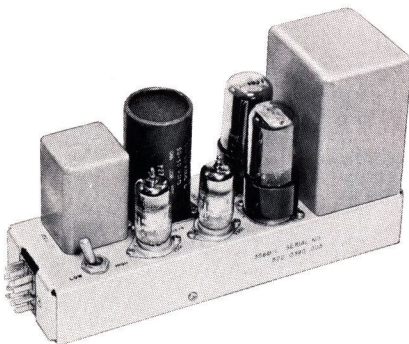

Used as the program line amplifier and monitor amplifier in Collins Consoles, the 356B-1 is a three stage amplifier with push-pull output and has a switch for high or low gain.

*Input Impedance:* Unloaded transformer, source impedance 150/600 ohms balanced or unbalanced, shipped wired for 600 ohms.

*Input Level:* -32 dbm.

*Output Impedance:* 150/600 ohms balanced or unbalanced, shipped wired for 600 ohms.

*Output Level:* +39 dbm (8 watts) maximum.

*Gain:* 56 db or 68 db, selected by toggle switch.

*Frequency Response:* ±1 db, 50-15,000 cps.

*Distortion:* 0.5% maximum at +30 dbm, 3% maximum at +39 dbm (8 watts).

*Noise:* -116 dbm at input, or 90 db below full output of 1 watt.

*Tubes:* Two 5879 and two 6V6.

*Power Requirements:* 6.3 v ac at 1.2 amps. 63 ma at 250 v dc at 1 watt output. 75 ma at 300 v dc at 1 watt output. 88 ma at 300 v dc at 8 watts output.

*Size:* 2 7/8" W, 5 3/4" H, 9 1/2" D.

*Weight:* 6 lbs.

Part No. 522 0390 005  
No Part Number  
100% spare tube kit.

\$88.00  
\$9.00

## COLLINS 356E-1 LIMITING AMPLIFIER

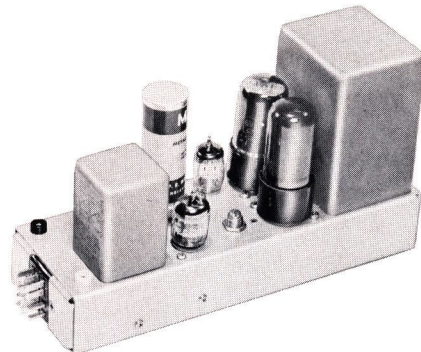

Designed for Collins Speech Input Consoles to permit unattended remote audio operation, the 356E-1 can be used to control level differences between two or more sources, as a program line compressor, in an expander-compressor operation or as a program amplifier.

The module consists of a push-pull variable gain input stage driving a push-pull output stage. A bias rectifier provides bias to regulate gain of the input stage. A decal to convert a VU meter to a gain reduction meter is furnished with the unit.

*Input Impedance:* Unloaded transformer, source impedance 150/600 ohms balanced or unbalanced, shipped wired for 600 ohms.

*Input Level:* -54 dbm to -24 dbm, with threshold control set at 0 dbm output. -34 dbm to -4 dbm, with threshold control set at +20 dbm output. -24 dbm to +6 dbm, with threshold control set at +30 dbm output. (0 dbm equals 1 mw across 600 ohms.)

*Output Impedance:* 150/600 ohms balanced or unbalanced.



## SPEECH INPUT

anced, shipped wired for 600 ohms.

**Output Level:** 0 dbm to +18 dbm, with threshold control set at 0 dbm output. +20 dbm to +30 dbm, with threshold control set at +20 dbm output. +30 to +36 dbm, with threshold control set at +30 dbm output.

**Response:** ±1 db, 50-15,000 cps.

**Distortion:** 1.5% maximum, 50-15,000 cps, with no compression. 2% maximum, 50-15,000 cps, at any level up to 30 db gain reduction, with threshold control set at +20 dbm output.

**Output Noise:** -50 dbm or less, with threshold control set for +20 dbm output.

**Compression Ratio:** Adjustable 1.6:1 to 5:1, with 3:1 optimum performance over a 30 db range at input.

**Attack Time:** 11 milliseconds, with switch set for dual operation. 62 milliseconds, with switch set for average operation.

**Release Time:** 0.9 seconds for 63% recovery, with switch set for dual operation. 5.2 seconds for 63% recovery, with switch at average operation.

**Gain:** 54 db.

**Controls:** Dual/Average toggle switch at top near front of chassis.

**Tubes:** One GL-6386 Variable Gain Input Amplifier, two 6V6GT Output Amplifiers and one 6AL5 Bias Rectifier.

**Power Source:** 6.3 v ac at 1.55 amps. 300 v dc at 77 ma.

**Size:** 3" W, 5<sup>3</sup>/<sub>8</sub>" H, 9" D.

**Weight:** 5 lbs.

**Part No. 522 0394 005**  
**No Part Number**  
 100% spare tube kit.

**\$130.00**  
**\$11.00**

## COLLINS 356Q-1 CUE AMPLIFIER

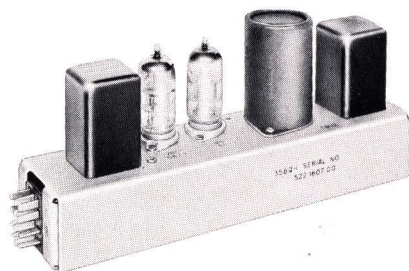

Designed for use in the Collins Consoles, the 356Q-1 is a two stage amplifier used to amplify signals from the cueing line. The 212G-1 has provisions for controlling the gain of the amplifier and includes a speaker for the output.

**Gain:** 55 db.

**Range:** 300-10,000 cps.

**Input Level:** -30 dbm nominal.

**Output Level:** +20 dbm (100 mw) nominal.

**Input Impedance:** 600 ohms nominal.

54

**Output Impedance:** 4 ohms.

**Tubes:** Two 5879.

**Power Requirements:** 6.3 v ac or dc at 0.3 amp. 300 v dc at 7.5 ma.

**Size:** 2<sup>1</sup>/<sub>8</sub>" W, 4<sup>5</sup>/<sub>8</sub>" H, 9<sup>1</sup>/<sub>2</sub>" D.

**Weight:** 2<sup>1</sup>/<sub>4</sub> lbs.

**Part No. 522 1607 00**  
**No Part Number**  
 100% spare tube kit.

**\$56.00**  
**\$3.50**

## COLLINS 409X-2 POWER SUPPLY

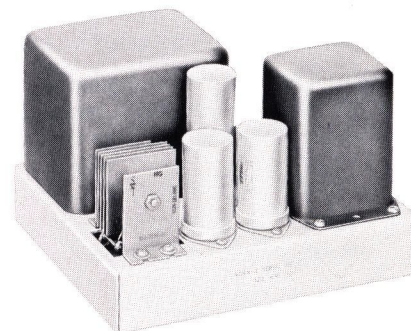

A plug-in module for Collins Consoles, this unit uses silicon rectifiers in the high voltage circuit for long life and to eliminate heat associated with vacuum tube rectifiers.

**Output Voltages:** Up to 250 ma at 300 v dc adjustable. 6.0 amps at 6.3 v ac. 1.0 amp at 12 v dc.

**Power Requirements:** 115/230 v ac ±10%, 50-60 cps, single phase.

**Power Input:** 225 watts maximum.

**Size:** 8" W, 6" H, 9<sup>1</sup>/<sub>2</sub>" D.

**Weight:** 25 lbs.

**Part No. 522 1691 00**

**\$110.00**

## COLLINS 409Y-1 POWER SUPPLY

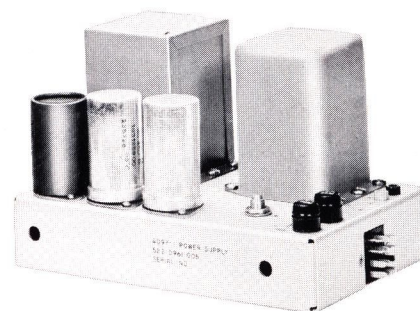

A small, general purpose power supply, the 409Y-1 is often used as an additional power supply with the



Collins 212E-1 Speech Input Console and has the same voltages as the 409X-2 but offers no dc voltages for relays.

*Output Voltages:* Up to 100 ma at 300 v dc, adjustable.  
3 amps at 6.3 v ac.

*Power Source:* 115/230 v ac, 50-60 cps, single phase  
(supplied wired for 115 v, 50/60 cps).

*Size:* 5½" W, 5⅝" H, 9½" D.

Part No. 522 0961 005

\$70.00

## COLLINS 274K-1 RELAY UNIT

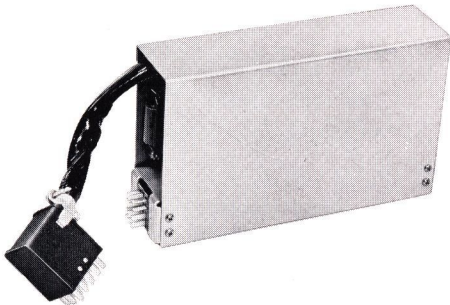

Used in Collins 212E-1 Console, this unit has four relays to control studio speakers and warning lights. Each relay is provided with a series shunt circuit to minimize switching transients and arcing. Noise is held to a minimum by mounting the relays on rubber. The 409X-2 Power Supply provides 12 v dc at 1 amp and studio wiring provides power for the warning lights.

*Connectors:* Howard Jones P-312-AB connector mounted on the front surface and P-315-CCE connector on a 5½" pendent cable.

*Size:* 2½" W, 5½" H, 9" D.

*Weight:* 2½ lbs.

Part No. 522 0391 005

\$85.00

## COLLINS 274K-2 RELAY UNIT

Used with the Collins 212G-1 and 212F-2 Consoles, the 274K-2 is similar to the 274K-1 in all specifications except that relays are unenergized in standby.

Part No. 522 1606 00

\$78.00

## COLLINS 499G-1 SHELF

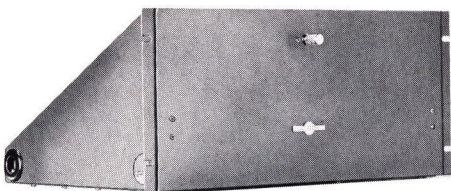

The 499G-1 is a rack mounting shelf used to mount

amplifiers, relay units and power supplies associated with the Collins 212E-1 Speech Input Console. The unit is a fixed type rack mounting shelf with a hinged, front panel 8½" H by 17⅜" W. The floor of the shelf is of cadmium plated, perforated sheet metal.

A Howard Jones barrier strip is mounted at the front or back of the unit. Holes on both sides at front and back allow wiring to individual style. The perforated bottom plate allows mounting components without drilling additional holes.

*Size:* 19" W, 8¾" H, 14" D. *Weight:* 11 lbs.

Part No. 522 0774

\$52.50

## COLLINS CONSOLE TEST CABLE



Permits operation and service of any module while removed from the console cabinet.

Part No. 541 6473 003

\$19.75

## COLLINS CONSOLE JUMPER PLUG

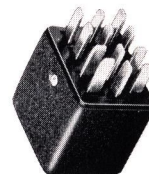

For use where high level signal inputs eliminate the need for 356A-1 Preamplifiers.

Part No. 541 6459 002

\$2.50

## COLLINS PLUG-IN BRACKET ASSEMBLIES

Plug-in bracket assemblies in 12-pin models without cable are available to facilitate mounting of 356A/B/E-1 Amplifiers in the 499G-1 Rack Mounting Shelf. Also available are 12- and 15-pin plug-in bracket assemblies with cable for use with 274K-1 or 274K-2 Relay Units.

Part No. 542 3038 002  
12-pin assembly without cable. \$3.00

Part No. 542 3040 003  
12-pin assembly with cable. \$5.25

Part No. 542 3039 002  
15-pin assembly without cable. \$5.50

Part No. 542 3041 004  
15-pin assembly with cable. \$7.25



# SPEECH INPUT

## COLLINS 26J-1 AUTO-LEVEL LIMITING AMPLIFIER

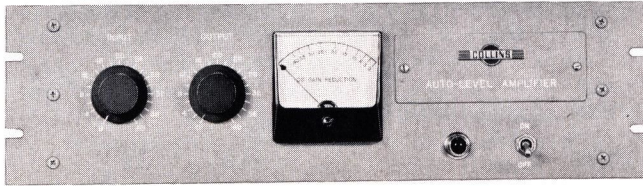

The average program level of the radio broadcast station can be automatically and effectively raised with the Collins 26J-1 Auto-Level Limiting Amplifier. The resulting effect of the 26J-1 is similar to turning up the volume of the radio receiver so that the low level transmission is as well received as the high level transmission.

Automatic fades between microphone and recorded music are also accomplished with the 26J-1. By setting the microphone level at a higher level than the turntable, the automatic fade occurs when the microphone is activated. The higher microphone level automatically fades the music into the background and allows the speech to come through clearly. When the voice portion is absent, the 26J-1 restores the music level to normal. Since these fades are done automatically and electronically, they are far smoother and superior to manual fades.

The 26J-1 does not act as a peak limiting amplifier but functions on a low compression ratio which allows limiting action without noticeable effect on program material. With the slow action and compression ratio of the 26J-1, it is possible to limit up to 30 db without a noticeable effect other than bringing up the average listening level of the program material.

Working in conjunction with the Collins 26U-1 Peak Limiting Amplifier, the two units provide excellent peak limiting as well as average program limiting. The wide dynamic ranges used in most classical and popular music require considerable compression to allow low and high passages to be broadcast equally well.

The Collins 26U-1 Peak Limiting Amplifier, ideally located at the transmitter, protects over-modulation of the transmitter, and the 26J-1 Auto-Level Limiting Amplifier, located at the studio, boosts the average and

low level program portions. Thus, these two units allow even the low-priced home and car receivers, which are not capable of reproducing wide dynamic ranges, to receive the entire broadcast as transmitted.

In those instances where there is not a good signal-to-noise ratio, such as old phonograph records and sports events with background noises, the 26J-1 can be operated as a straight amplifier. The limiting action may be disabled by turning off the gain reduction switch.

*Frequency Response:*  $\pm 1$  db, 50-15,000 cps.

*Gain:* 25 db maximum as shipped. 41 db maximum, with input pad changed from 22 db to 6 db.

*Input Impedance:* 600 ohms unbalanced.

*Input Level:* Adjustable,  $-26$  dbm to  $+30$  dbm. Easily changed 22 db "T" pad in input circuit available. (0 dbm equals 1 mw across 600 ohms.)

*Output Impedance:* 600 ohms unbalanced.

*Output Level:* Adjustable,  $-24$  dbm to  $+30$  dbm;  $+14$  dbm nominal.

*Distortion:* 1.5% maximum, 50-15,000 cps, with no compression. 2% maximum distortion, 50-15,000 cps, at any level up to 30 db gain reduction, with threshold set for 3:1 compression ratio.

*Output Noise:*  $-50$  dbm or less. (Threshold set for 3:1 ratio.)

*Compression Ratio:* 3:1 optimum; adjustable 1.6:1 to 5:1.

*Attack Time:* 11 milliseconds, with switch set for dual operation. 62 milliseconds, with switch set for average operation.

*Release Time:* 0.9 seconds for 63% recovery, with switch set for dual operation. 5.2 seconds for 63% recovery, with switch set for average operation.

*Power Source:* 115 v or 230 v ac, 50-60 cps, single phase. Shipped wired for 115 v.

*Size:* 19" W, 5½" H, 9" D.

*Weight:* 16 lbs.

Part No. 597 0359 00

\$275.00

No Part Number

\$13.81

FCC set of spare tubes (includes two silicon rectifiers).

BLOCK DIAGRAM 26J-1

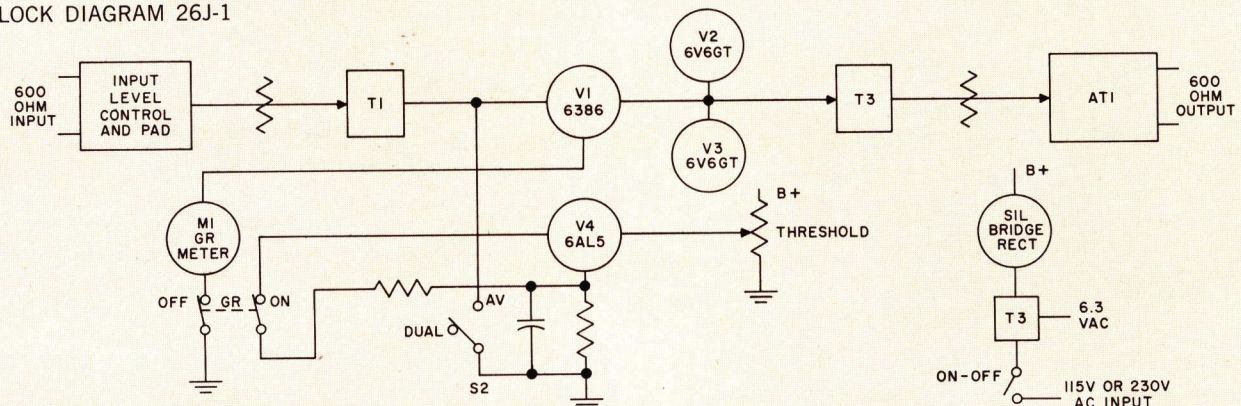



## COLLINS 26U-1 LIMITING AMPLIFIER

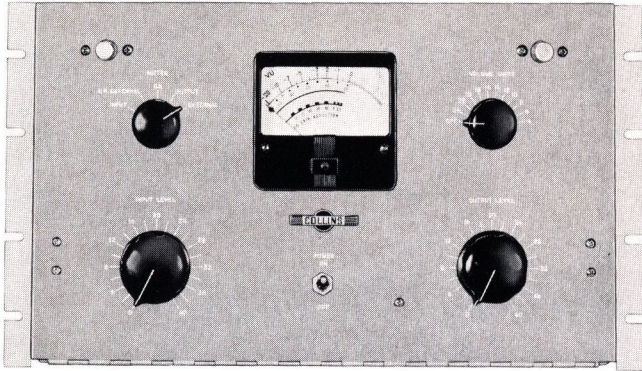

Designed to achieve maximum modulation with minimum distortion, the Collins 26U-1 Limiting Amplifier provides full tonal range broadcasting with thump-free performance.

The Collins Limiting Amplifier limits loud audio passages to prevent overmodulation, distortion and adjacent channel interference, while allowing low level passages to be broadcast in their true range.

The transmission range of the station's signal and the over-all efficiency of the transmitter are increased through the limiting action which permits a higher average modulation level.

When used with recording equipment or with a public address system, the 26U-1 prevents overloading, and by allowing a higher average audio level, the limiting amplifier improves the signal-to-noise ratio.

A self-balancing circuit eliminates the need of tube selection or delicate balancing procedures usually associated with peak limiters. The Collins Limiting Amplifier is capable of greater than 30 db compression.

Conventional circuitry, negative feedback, full wave rectification for control voltage and silicon rectifiers in the power supply are incorporated into this unit.

An illuminated VU meter with a special scale calibrated in VU and db of compression, which measures five functions, is provided in the Collins Limiting Amplifier. The VU meter attenuator and a rotary switch allow measurement of external gain reduction, db of compression and levels of input, output and external audio circuits. This external meter circuit measures

audio levels on other program lines, eliminating the need for an additional VU meter panel.

Silicon diodes and extended life electrolytic capacitors provide an efficient, low heat power supply with a minimum of maintenance. A voltage regulator provides stabilized reference voltages. Input, output and VU meter level controls are Daven step-type.

The 26U-1 consists of a push-pull variable gain input stage, a push-pull interstage voltage amplifier, and a push-pull output stage. A bias rectifier supplies dc bias from the signal output to regulate the gain of the input stage. A self-contained power supply provides the plate and filament voltages.

Designed for rack mounting, the Collins Limiting Amplifier has a minimum number of controls, tubes and tube types. It has a hinged front panel for access to internal wiring and components.

The panel is finished with blue-gray enamel, and the chassis is cadmium plated and chromate dipped.

*Frequency Response:*  $\pm 1.5$  db, 50-15,000 cps.

*Gain:* 32 db minimum.

*Input Impedance:* 600 ohms unbalanced.

*Input Level:* -20 dbm to +20 dbm. Note: 0 dbm equals 1 mw across 600 ohms.

*Output Impedance:* 600 ohms unbalanced adjustable, or 600 ohms balanced fixed level.

*Output Level:* -20 dbm to +20 dbm.

*Distortion:* 1.5% maximum.

*Output Noise:* -50 dbm or less.

*Compression Ratio:* 12:1 first 10 db above threshold.

*Attack Time:* Adjustable, 0.5-3.0 milliseconds.

*Release Time:* Adjustable, 2.2-5.2 seconds for 63% recovery.

*Power Source:* 115 v or 230 v ac, 50-60 cps, single phase. Shipped wired for 115 v.

*Size:* 19" W, 10½" H, 9" D.

*Weight:* 32½ lbs.

Part No. 522 0966 00

No Part Number

100% set of spare tubes.

\$425.00

\$15.00

BLOCK DIAGRAM 26U-1

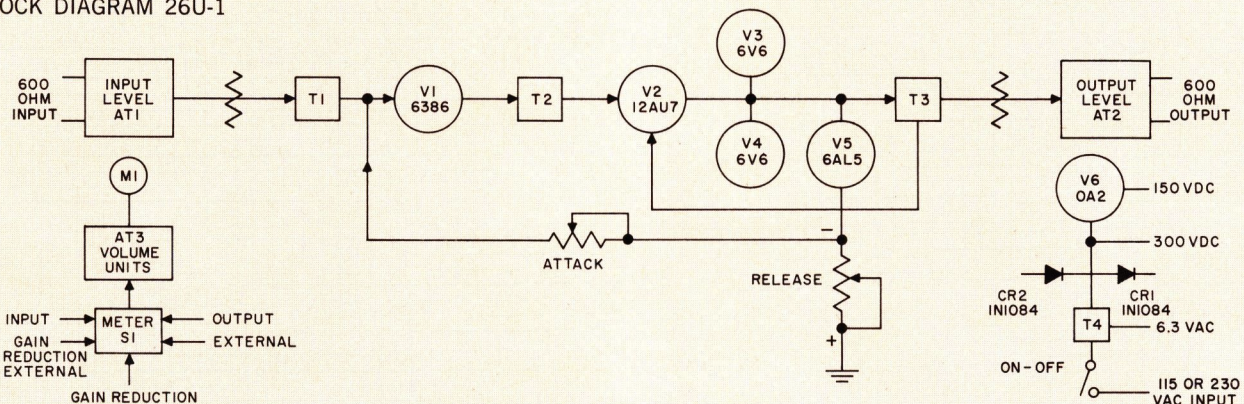



# RECORDING

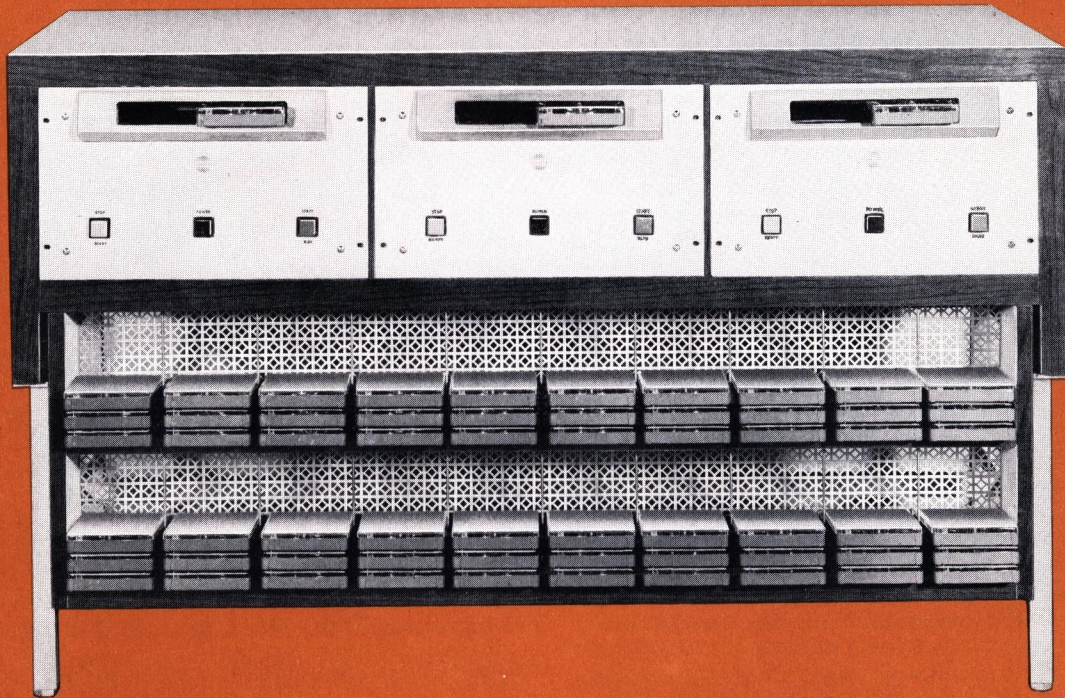

## COLLINS 642A-1 AND 216C-1 AUTOMATIC PROGRAMMING EQUIPMENT

Automatic tape programming with Collins equipment means perfection in recording and playback. Stored in 40-second to 31-minute endless tape cartridges, programs are conveniently and safely stored until air time. Then, the cartridge is inserted into the playback deck, one button pressed, and the program is on the air, on cue.

The ease of programming is only a feature of convenience to the broadcaster. The degree of perfection in cueing spot announcements and the resulting tight production are features the listening audience can observe as a mark of the truly professional broadcaster.

Cueing the tape with Collins equipment is an automatic process not dependent upon human skills. A fraction of a second before the start of the recording process on the upper half of the tape, a tone burst is recorded on the bottom half of the tape. This tone burst automatically stops the endless tape during the playback operation so that there is less than a 0.1-second start time for the next play.

The tone burst recorded on the tape automatically recues the tape for the next play. The playback units contain the necessary relay switching to automatically switch audio feed from an unlimited number of units into a single input of the speech input console. When any unit is started, all others are automatically disconnected from the line. Any unit that is running when another unit is started will continue to run until it is cued to the start position or is manually stopped.

The cartridge is inserted along a guide and under a sturdy retaining spring which keep the entire cartridge firmly in place. Pressure pads within the cartridge hold the tape flat and firmly against the record/playback head and cue head. A precision gap of 0.00015 of an inch in the record/playback head provides resolution of the complete audio range at the 7½-inch tape speed. The heads are built on laminated cores, which permit high recording levels without danger of core saturation. The laminated cores and the balanced double coil winding result in a signal-to-



noise ratio of 55 db or better as measured by the proposed NAB standard of 400 cps at 3% THD.

The capstan pressure roller, pivoting 110° from below the deck surface, snaps into position to hold the tape securely against the driving capstan. The tension of this roller is easily adjustable. The pressure roller resists wear and is accurately ground so that the tape is not fluted or stretched as it passes between the capstan and the pressure roller.

Pulling the pressure roller into position is a heavy duty solenoid guaranteed to last. This solenoid was activated over 2-million times in the Collins Quality Control laboratories and showed no appreciable wear. The pressure roller linkage system moves along two highly polished nylon tracks. Activation of the solenoid and pressure roller is a fast, tight operation. Shimmy and vibration are not present.

Mounted on a strong and accurately machined cast aluminum deck, the mechanical portions of the Collins playback and recorder units are guaranteed to stay in perfect alignment. The precision of the playback and record heads in relation to the capstan, solenoid-activated linkage system and flywheel requires more than a pressed mounting plate. The Collins deck has a cast structural reinforcement so that alignment of all moving parts is always perfect.

Driving the unit is a heavy duty Bodine synchronous motor with vertical ball thrust bearing. The motor is energized by inserting a tape cartridge. The life and low wear of the motor are features second only to the steady speed. The tape is moved through the unit at 7½ inches per second with 99.6% accuracy.

The motor is coupled to the flywheel with three resilient drive belts. This indirect drive, found in premium grade tape equipment, features much greater driving torque than in direct drive capstan systems. This torque is a must for syllable-splitting cueing required by present day broadcasting standards.

The machined and highly polished solid brass flywheel is typical of Collins precision. The flywheel and capstan, with two Oilite lateral bearings and a ball thrust vertical bearing, are absolutely wear-resistant and maintain their equal balance. The result is very important: the Collins playback unit holds flutter and wow to less than 0.2 of 1% RMS.

The units are finished in a blue-gray baked enamel, and extenders are furnished for rack mounting or other 19" width mounting requirements. The following specifications apply to both the 216C-1 Record and 642A-1 Playback Units:

*Power Source:* 105-125 v ac, 60 cps (50 cps model available on order), single phase.

*Frequency Response:* ±2 db 50-12,000 cps, ±4 db 50-15,000 cps, with 1,000 cps reference frequency.

*Harmonic Distortion:* 2% or less at 0 VU record level.

*Signal-to-Noise Ratio:* 55 db or better at 400 cps.

#### 642A-1 PLAYBACK SPECIFICATIONS

*Power Consumption:* 100 watts during operation, 25 watts standby.

*Gain:* 55 db at 1,000 cps.

*Size:* 15" or 19" W, 8¾" H, 13¾" D.

*Weight:* 40 lbs.

Part No. 522 2547 00 (Type 642A-1 Playback) \$575.00

#### 216C-1 RECORD SPECIFICATIONS

*Power Consumption:* 125 watts.

*Audio Inputs:* Microphone and line, both variable gain and capable of being mixed. Microphone input 250 ohm impedance (50/600 ohms optional). Will accommodate input levels from -65 dbm to -35 dbm. Line input 600 ohm impedance (50/250 ohms optional). Will accommodate levels from -15 dbm to +10 dbm.

*Size:* 15" or 19" W, 7" H, 13¾" D.

*Weight:* 15 lbs.

Part No. 522 2548 00 (Type 216C-1 Record) \$350.00

### COLLINS DESK WING CONSOLE

Functional and economical unit for housing three 15" Collins automatic programming playback units (or two playback units and one record unit) and 120 of the Series 300 tape cartridges. Sturdy construction and wear resistant Formica finish in walnut (DWW-3). Other finishes available on request. *Size:* 51" W, 30" H, 18" D. *Weight:* 150 lbs.

Part No. 097 5350 00 \$250.00

### COLLINS PRODUCTION CONSOLE CABINET

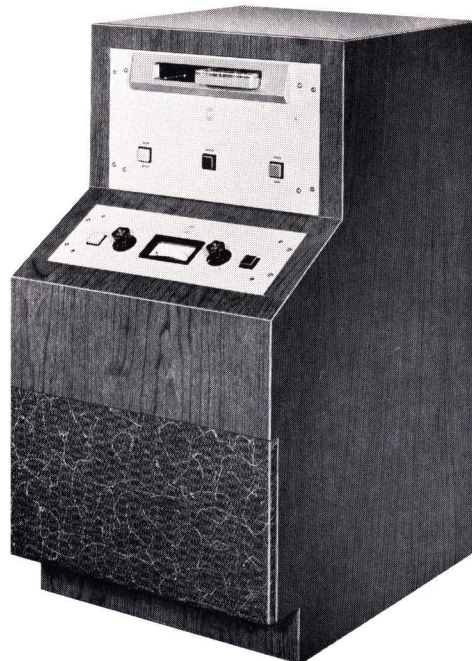

Complete Collins automatic programming recording and playback facilities may be mounted in this cabinet. Houses one 15" playback and one 15" recording amplifier. Has cutout for one 8" speaker (not included). Walnut (CWW-1) Formica finish. Other finishes available on request. *Size:* 18" W, 34" H, 24" D. *Weight:* 85 lbs.

Part No. 097 7522 00 \$110.00



# RECORDING

## COLLINS TAPE CARTRIDGE RACK

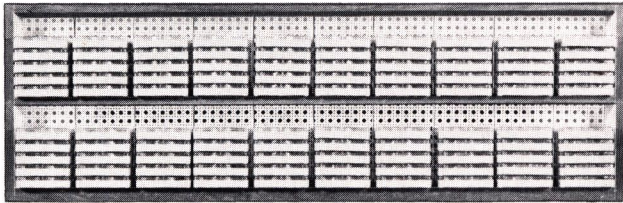

Formica covered wood rack holds 120 of the Series 300 cartridges used with Collins automatic programming equipment. Four rubber cushions allow rack to be set on top of programming wing. It also may be hung on wall. Walnut Formica. Other finishes available on request. *Size:* 45 $\frac{3}{4}$ " W, 14 $\frac{3}{8}$ " H, 4" D. *Weight:* 25 lbs.

Part No. 097 5727 00

\$52.50

## ABCO LAZY SUSAN CARTRIDGE RACK

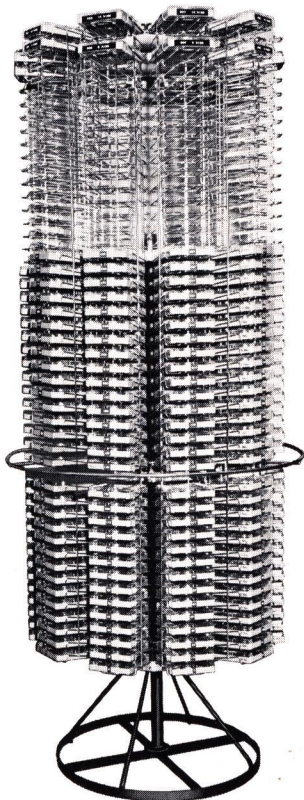

This sturdy, heavy Lazy Susan rack holds 500 of the Series 300 Collins automatic programming equipment tape cartridges. Ten chrome-plated racks with 50 slots each make storage and selection of cartridges fast and simple. Revolves easily on roller bearing hub and will not tip regardless of arrangement of cartridges. Cartridges held in wire holders at an angle to prevent slipping out while the rack is being revolved. Shipped knocked down. *Size:* Approx. 72" H, 36" diameter. *Weight:* Approx. 50 lbs.

Part No. 097 7559 00

\$275.00

60

## ABCO WIRE CARTRIDGE RACK

Individual wire rack holding 50 Collins automatic programming equipment cartridges. Identical rack to those used in the Lazy Susan. Includes tapped mounting brackets welded to wire rack. *Size:* Approx. 5" W, 1 $\frac{1}{2}$ " H, 7" D. *Weight:* Approx. 2 lbs.

Part No. 097 7560 00

\$25.00

## COLLINS 313T-4 REMOTE CONTROL PANEL

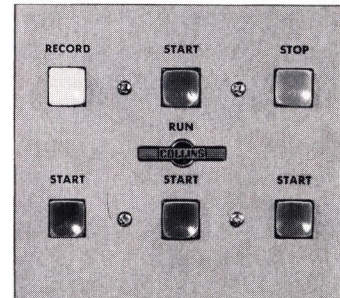

Three Collins automatic programming playback units, in addition to a record/playback system, may be operated with this control panel from a remote point in the broadcast studio. Buttons illuminate when in operation. *Size:* 5 $\frac{1}{8}$ " W, 2 $\frac{3}{4}$ " H, 4 $\frac{1}{2}$ " D.

Part No. 522 2552 00

\$55.00

## COLLINS 313T-3 REMOTE CONTROL PANEL

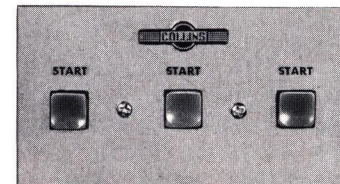

Has three illuminated "start" buttons for control of three or less playback units from a remote point. *Size:* 5 $\frac{1}{8}$ " W, 4 $\frac{1}{2}$ " H, 4 $\frac{1}{2}$ " D.

Part No. 522 2551 00

\$32.50

## COLLINS 313T-1 REMOTE CONTROL PANEL

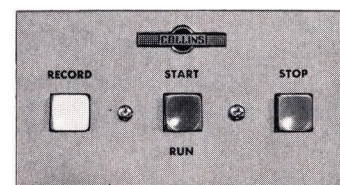

Has illuminated "start," "record" and "stop" buttons for control of one record/playback system from a remote point. *Size:* 5 $\frac{1}{8}$ " W, 2 $\frac{3}{4}$ " H, 4 $\frac{1}{2}$ " D.

Part No. 522 2550 00

\$32.50



## COLLINS AUTOMATIC PROGRAMMING LOADED CARTRIDGES

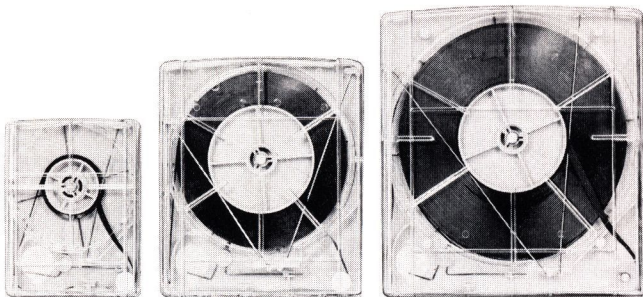

300

600

1200

Manufactured for Collins automatic programming equipment, these cartridges are loaded with fine quality, specially lubricated tape.

**300 Series:** Loaded cartridges packed six per box (minimum one box) in following lengths: 40, 70, 90, 100 seconds; 2½, 3, 3½; 5, 5½, 7, 7½, 10, 10½ minutes. Specify length.

Part No.	Length	Price
097 5205 00	40 seconds	\$15.00 per box
097 5206 00	70 seconds	\$15.30 per box
099 0191 00	90 seconds	\$15.60 per box
099 0192 00	100 seconds	\$15.90 per box
099 0193 00	2½ minutes	\$16.80 per box
099 0194 00	3 minutes	\$17.70 per box
097 5207 00	3½ minutes	\$18.00 per box
099 0195 00	5 minutes	\$19.80 per box
097 5208 00	5½ minutes	\$20.70 per box
099 0196 00	7½ minutes	\$23.40 per box
099 0197 00	10 minutes	\$25.80 per box
097 5209 00	10½ minutes	\$26.40 per box

**600 Series:** Loaded cartridges packed two per box (minimum one box) in following lengths: 11, 13½, 15, 16 minutes. Specify length.

Part No.	Length	Price
099 0198 00	11 minutes	\$11.00 per box
099 0199 00	13½ minutes	\$11.90 per box
099 0200 00	15 minutes	\$12.60 per box
097 5210 00	16 minutes	\$13.00 per box

**1200 Series:** Loaded cartridges packed two per box (minimum one box) in 31 minute lengths.

Part No. 097 5211 00 \$21.50 per box

## COLLINS AUTOMATIC PROGRAMMING BLANK CARTRIDGES

Identical to above cartridges for custom loading.

**300 Series:** Blank cartridges packed six per box (minimum one box). Up to 10½ minutes playing time.

Part No. 097 5528 00 \$13.20 per box

**600 Series:** Blank cartridges packed two per box (minimum one box). From 11 to 16 minutes playing time.

Part No. 097 5914 00 \$6.50 per box

**1200 Series:** Blank cartridges packed two per box (minimum one box). From 16½ to 31 minutes playing time.

Part No. 097 5915 00 \$9.40 per box

## COLLINS AUTOMATIC PROGRAMMING MM-151 BULK RECORDING TAPE

A fine quality, specially lubricated, Minnesota Mining tape in bulk lengths of 1,700' on 7" reels for use with Collins Automatic Programming blank cartridges.

Part No. 097 5852 00 \$7.07 each

For 12 or more, see below.

Part No. 097 5852 00 \$6.36 each  
12 or more.

## COLLINS AUTOMATIC PROGRAMMING TEST TAPE

Azimuth head alignment test tape for Collins automatic programming playback in 70-second length with 5,000 cps tone on cue track and 10,000 cps tone on program track.

Part No. 097 6076 00 \$6.00

## TAPE CARTRIDGE REPAIR KIT

Collins Automatic Programming cartridges may be repaired easily with this repair kit which includes 12 Teflon washers, 12 pressure pads and 12 center screws.

Part No. 099 0066 00 \$4.50

Minimum order of three kits as described above. \$1.50 per kit.

## AUDIOTAPE AND MM RECORDING TAPES

The following tapes are designed for conventional recorders (see description under Collins Automatic Programming MM-151 Bulk Recording Tape for specially lubricated bulk tape):

1251: Audiotape, 1200 ft., 7" reel.

1861: Audiotape, Mylar, 1800 ft., 7" reel.

111A-6: Minnesota Mining tape, 600 ft., 5" reel.

111A-12: Minnesota Mining tape, 1200 ft., 7" reel.

150-18: Minnesota Mining tape, Mylar, 1800 ft., 7" reel.

190-18: Minnesota Mining tape, plastic base, 1800 ft., 7" reel.

Part No. 097 2039 00 (Type 1251) \$2.34 each  
For 10 or more, see below.

Part No. 097 2039 00 (Type 1251) \$2.10 each  
10 or more.

Part No. 097 2992 00 (Type 1861) \$4.33 each  
For 10 or more, see below.

Part No. 097 2992 00 (Type 1861) \$3.90 each  
10 or more.

Part No. 272 1408 00 (Type 111A-6) \$1.50 each

Part No. 272 1407 00 (Type 111A-12) \$2.34 each  
For 12 or more, see below.

Part No. 272 1407 00 (Type 111A-12) \$2.10 each  
12 or more.

Part No. 097 7112 00 (Type 150-18) \$4.13 each  
For 12 or more, see below.

Part No. 097 7112 00 (Type 150-18) \$3.72 each  
12 or more.

Part No. 099 0040 00 (Type 190-18) \$3.67 each  
For 12 or more, see below.

Part No. 099 0040 00 (Type 190-18) \$3.30 each  
12 or more.



## RECORDING

### REEVES ST-466 BULK SPLICING TAPE

Reeves splicing tape for use with Collins Automatic Programming equipment recording tape. Mylar 1½ mil tape ¾" wide and supplied in 66' roll.

Part No. 099 0496 00

\$1.35

### ROBINS TS4-DLX SPLICER-CUTTER



Used for magnetic recording tape, this unit cuts two rounded indentations in the tape splice, giving the splice a "Gibson Girl" shape and leaving the edges of the tape free of adhesive. The unit can be removed from its base and mounted directly on any tape recorder. It comes complete with a roll of splicing tape and tape feed.

Part No. 097 2058 00

\$8.60

### MAGNERASER 200C TAPE ERASER



A compact and convenient bulk tape eraser that removes recorded signals from tape up to 35 mm in size and lowers background noise level up to 6 db below that of unused tape. A pushbutton safety switch prevents current from being applied when not in use. *Operating Voltage:* 100-130 v, 50-60 cps. *Size:* 2" H, 4" diameter. *Weight:* 2½ lbs.

Part No. 097 5172 00

\$18.00

### MICROTRAN HD-11M TAPE ERASER

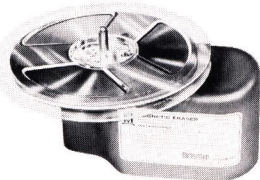

A bulk tape demagnetizer that develops a high intensity magnetic field to erase signals and noise without rewinding. Spindle mounting of reel permits rapid and thorough coverage. *Reel Size Range:* 5", 7", 10½" (spindle removable for use with other size reels). *Adapter Hub:* Available for use with 10½" reels. *Rating:* 117 v ac, 5 amps. *Size:* 5" W, 3" H, 8" D.

Part No. 099 0371 00

\$18.95

### AMPEX 601 SERIES RECORDER

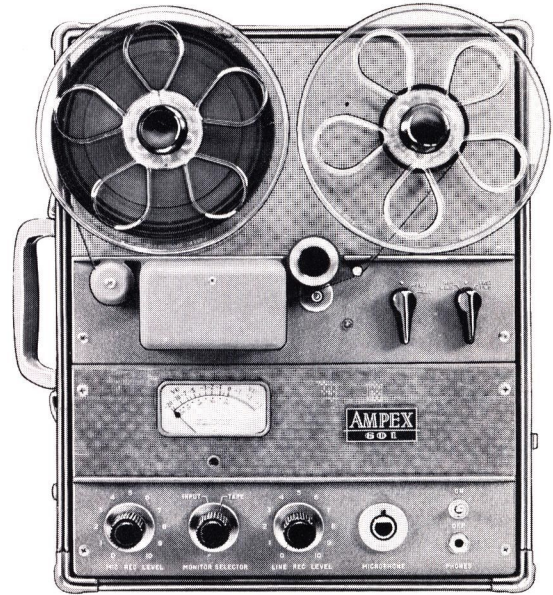

A lightweight and convenient portable recorder that is ideal in a variety of broadcast situations, the Ampex 601 has synchronous motor drive with a timing accuracy within 3.6 seconds during 30 minutes playback. Record and playback amplifiers are separate units.

The 601 Series is available in the following combinations: Portable — 7½ ips, half-track (Model 652); 7½ ips, full-track (Model 654); 3¾ ips, half-track (Model 656); and 3¾ ips, full-track (Model 658). Unmounted 7½ ips, half-track (Model 662); 7½ ips, full-track (Model 664); 3¾ ips, half-track (Model 666); and 3¾ ips, full-track (Model 668). Stereo portable — 7½ ips (Model 672) and 3¾ ips (Model 674). Stereo unmounted — 7½ ips (Model 676) and 3¾ ips (Model 678). Be sure to specify type number for correct combination.

*Frequency Response:* Down no more than 4 db 40-15,000 cps, ±2 db 40-10,000 cps. *Signal-to-Noise Ratio:* Over 55 db at 3% with full-track head. *Playback Output:* 600 ohms, 1.23 ohms balanced or unbalanced. *Power Requirements:* 117 v, 60 cps (50 cps on order), 0.52 amp, 61 watts. *Size:* 13¾" W, 16½" H, 8" D. *Weight:* Approx. 28 lbs.

Part No. 099 0467 00	(Type 652)	\$595.00
7½ ips, half track, with case.		
Part No. 099 0468 00	(Type 654)	\$595.00
7½ ips, full track, with case.		
Part No. 099 0469 00	(Type 656)	\$625.00
3¾ ips, half track, with case.		
Part No. 099 0470 00	(Type 658)	\$625.00
3¾ ips, full track, with case.		
Part No. 099 0471 00	(Type 662)	\$545.00
7½ ips, half track, unmounted.		
Part No. 099 0472 00	(Type 664)	\$545.00
7½ ips, full track, unmounted.		
Part No. 099 0473 00	(Type 666)	\$575.00
3¾ ips, half track, unmounted.		
Part No. 099 0474 00	(Type 668)	\$575.00
3¾ ips, full track, unmounted.		
Part No. 099 0475 00	(Type 672)	\$995.00
7½ ips, stereo, with case.		
Part No. 099 0476 00	(Type 674)	\$1,045.00
3¾ ips, stereo, with case.		
Part No. 099 0477 00	(Type 676)	\$950.00
7½ ips, stereo, unmounted.		
Part No. 099 0478 00	(Type 678)	\$995.00
3¾ ips, stereo, unmounted.		



## AMPEX 620 AMPLIFIER-SPEAKER



An ideal companion unit designed to match the Ampex 601 Series Recorder, the 620 has an 8-inch speaker that utilizes a high degree of bass and treble boost without undue harmonic or intermodulation distortion. The 10-watt power amplifier is of push-pull design. It is conventional high fidelity type but is unusual for its fast transient overload recovery.

*Over-all Frequency:* 65 to better than 10,000 cps. *Amplifier Frequency Response:* 20-20,000 cps,  $\pm 0.5$  db. *Input Impedance:* 20,000 ohms. *Output Impedance:* 12 ohms to external speaker. *Power Requirements:* 117 v, 50/60 cps, 0.5 amp, 55 watts. *Size:* 13" W, 16" H, 8" D.

Part No. 099 0483 00  
Amplifier-speaker, with case.

\$189.50

## AMPEX 351 TAPE RECORDERS



Designed for the most varied uses, the Ampex 351 is world renowned for meeting the high standards of the broadcast profession. It is available in console, portable or rack mounting, single track, double track or stereo versions, and can be mounted horizontally,

vertically or at any angle. It takes reels from 3" to 10 $\frac{1}{2}$ "; is available with speeds of 3 $\frac{3}{4}$  and 7 $\frac{1}{2}$  ips, or 7 $\frac{1}{2}$  and 15 ips.

The capstan idler, with solenoid control for accurate traction pressure, will disengage when power is shut off at end of reel and in case of power failure to avoid flat spots on idler puller. The unit uses direct drive hysteresis synchronous motor.

Available in console model (351C), portable model (351P) and rack mounting model (351U). These tape recorders are available for 50 cps operation on special order.

*Frequency Response:* 15 ips  $\pm 2$  db 30-15,000 cps; 7 $\frac{1}{2}$  ips  $\pm 4$  db 30-15,000 cps; 3 $\frac{3}{4}$  ips  $\pm 2$  db 50-7,500 cps. *Playback Timing Accuracy:*  $\pm 0.2\%$  ( $\pm 3.6$  seconds in 30 minutes). *Record Input:* Switch allows either microphone level low impedance input, or to bridge a 600 ohm line, balanced or unbalanced. *Playback Output:* +8 VU into 600 ohms, balanced or unbalanced. *Size:* Transport — 19" W, 15 $\frac{3}{4}$ " H. Amplifier — 19" W, 7" H. *Weight:* Transport — 58 lbs. Amplifier — 18 lbs.

Part No. 097 4693 00	(Type 351C)	\$1,750.00
60 cps, 7 $\frac{1}{2}$ and 15 ips,	full track.	
Part No. 099 0372 00	(Type 351P)	\$1,670.00
60 cps, 7 $\frac{1}{2}$ and 15 ips,	full track.	
Part No. 097 5145 00	(Type 351U)	\$1,570.00
60 cps, 7 $\frac{1}{2}$ and 15 ips,	full track.	

## MAGNECOR M-90AC RECORDER-AMPLIFIER

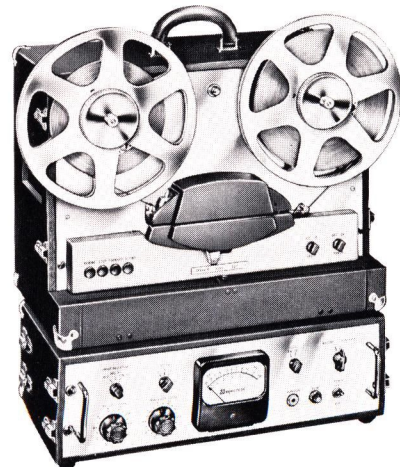

A portable recorder-amplifier combination, the M-90AC has a two-speed (7 $\frac{1}{2}$  and 15 ips) direct tape drive with outboard capstan bearing assuring low flutter. Integrated design, torque motor supply and take-up tension achieve timing accuracy of better than 3 seconds in 30 minutes. Available without carrying case (M-90ACX) for rack mounting and in monoaural or stereo models. Also available on special order are remote control (M-90R) and console cabinet.

*Frequency Response:*  $\pm 2$  db 30-15,000 cps at 15 ips,  $\pm 4$  db 30-15,000 cps at 7 $\frac{1}{2}$  ips. *Transport Size:* 19" W, 12 $\frac{1}{4}$ " H, 10 $\frac{1}{2}$ " D. *Weight:* 50 lbs. (with case). *Amplifier Size:* 19" W, 5 $\frac{1}{4}$ " H, 8 $\frac{3}{4}$ " D. *Weight:* 30 lbs. (with case).

Part No. 099 0462 00	(Type M-90AC)	\$1,385.00
Part No. 097 2888 00	(Type M-90ACX)	\$1,295.00
Part No. 097 2889 00	(Type M-90R)	\$40.00



# RECORDING

## MAGNECORD PT6-6A/J

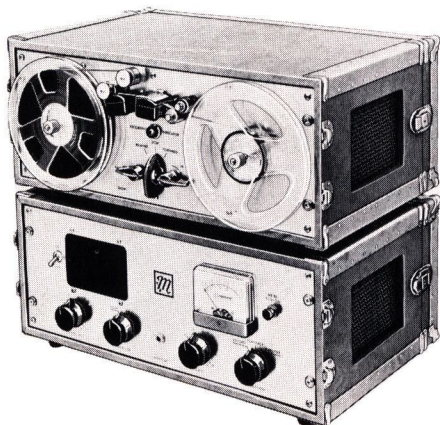

The PT6-6A Recorder and PT6-6J Amplifier are designed for either rack mounting or portable use. Powered by two-speed hysteresis synchronous motor for 7½ and 15 ips, selectable by switch. Low impedance and high impedance inputs are provided as well as 4, 8, 16 and 500 ohm outputs. The unit includes full-track erase and record/playback heads (half-track heads may be specified at no additional cost).

*Frequency Response:* ±2 db 50-15,000 cps at 15 ips; ±2 db 50-7,500 cps at 7½ ips. *Signal-to-Noise Ratio:* 50 db. *Distortion:* Less than 2% at 10 watts output. *Flutter:* 0.3% at 15 ips; 0.5% at 7½ ips. *Size:* Amplifier — 19" W, 7" H, 8" D. Recorder — 19" W, 7" H, 11" D. *Weight:* Amplifier — 21 lbs. in case. Recorder — 26 lbs. in case.

Part No. 097 3806 00	(Type PT6-6A)	\$425.00
With case.		
Part No. 097 4491 00	(Type PT6-6AX)	\$375.00
Without case.		
Part No. 097 3807 00	(Type PT6-6J)	\$295.00
With case.		
Part No. 097 4492 00	(Type PT6-6JX)	\$265.00
Without case.		

## SOUNDPAC TAPE PLAYBACK

A self-contained playback unit with 10 watt audio amplifier and speaker (TR-2) for playback of commercials recorded on Collins automatic programming equipment. Uses Collins continuous tape cartridges at 3¾ or 7½ ips. Available in portable case and in blonde, mahogany or walnut cabinet. *Size:* Approx. 14" W, 9" H, 14" D. *Weight:* Approx. 22 lbs.

Part No. 097 6151 00	\$169.50
----------------------	----------

## CROWN 800 TAPE RECORDERS

Available in either monaural or stereo models, the Crown B801 tape recorder has many advanced features to make it a professional unit for broadcast stations. Each unit is guaranteed to give top quality performance and is thoroughly tested to assure complete satisfaction.

Among its features: 3 heads for 15, 7½ and 3¾ ips operation, AM adjustment control, transistorized photo electric automatic stop for all functions, photo electric program cueing, all-electric relay and solenoid operation, 3-speed electronic reverberation for echo, auto-

matic shift from front panel for 3¾ and 7½ ips, automatic torque compensator, accepts 10½" reels, lowest record-playback intermodulation distortion in industry and over-size lifetime bearings. The stereo version (Type 824) is similar to the monaural unit shown except for the addition of an identical amplifier unit for the second channel. *Size:* Monaural — 19" W, 15" H, 10½" D. Stereo — 19" W, 18½" H, 10½" D. *Weight:* Monaural — 48 lbs. Stereo — 56 lbs.



Speed	Frequency Response	Flutter and Wow	Noise Ratio
15	±2 db, 30-30,000 cps	.06%	57 db
7½	±2 db, 30-20,000 cps	.09%	55 db
3¾	±3 db, 30-13,000 cps	.18%	51 db

Part No. 099 0479 00	(Type B801)	\$885.00
Less case.		
Part No. 099 0480 00	(Type 824)	\$995.00
Less case.		
Part No. 099 0481 00		\$52.00
Case for Type B801 monaural recorder.		
Part No. 099 0482 00		\$59.00
Case for Type 824 stereo recorder.		

## CROWN RC8 REMOTE CONTROL

This unit, with indicator light, is a duplicate of the rewind, play, forward and stop functions mounted on the recorder cabinet. The RC8 includes 25' cable.

Part No. 099 0158 00	\$85.00
Remote control unit.	

## CONCERTONE SERIES 90 TAPE RECORDERS

Designed for rugged reliability under continuous performance conditions, the Series 90 meets exacting broadcast requirements. The Concertone Edit-O-Matic® feature enables quick cueing, and a flutter filtering system virtually eliminates spurious vibrations and tape flutter.

The unit accommodates up to four heads for stereo. A multichannel erase head provides separate erase for each track to assure easy monophonic and sound-on-sound recording. Separate gain controls for each input signal permit recording from two different sources simultaneously, mixing sounds for proper balance. Handles all reel sizes from 5" to 10½". Available in monophonic full- or half-track and stereo 2- or 4-track versions in studio consoles, portable case or rack mounting.

*Tape Speeds:* 15 and 7½ ips; or 7½ and 3¾ ips. *Frequency Response:* ±2 db, 40-15,000 cps at 15 ips; ±2 db, 40-12,000 cps at 7½ ips; ±2 db, 50-7,500 cps at 3¾ ips. *Signal-to-Noise Ratio:* Full track — 55 db



at 7½ and 15 ips; 50 db at 3¾ ips. Stereo — 50 db at 7½ and 15 ips; 45 at 3¾ ips (based on 2% distortion). *Timing Accuracy:* 99.8% or better. *Flutter and Wow:* Less than 0.1% rms at 7½ and 15 ips; less than 0.3% rms at 3¾ ips. *Rewind and Fast Forward:* 90 seconds for 2,400 ft.

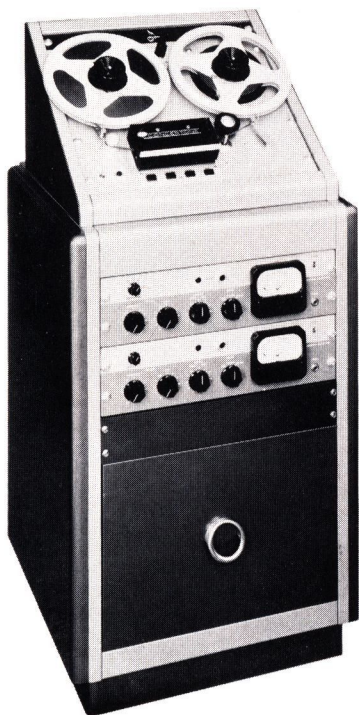

*Input Impedance:* High impedance unbalanced; 50, 250, 600 ohms balanced or unbalanced with plug-in transformers. *Output Impedance:* 600 ohms balanced with terminating switch to allow connections to high impedance input. *Output Level:* 0 VU. *Power Requirements:* Monophonic — Approx. 280 watts, 115 v, 60 cps (50 cps on special order). Stereo — Approx. 320 watts, 115 v, 60 cps. *Size:* Transport — 19" W, 15¾" H, 8" D. Amplifier — 19" W, 5¼" H, 8¼" D. *Weight:* Transport — 48 lbs. Amplifier — 12 lbs.

<b>Part No. 099 0373 00</b>	(Type 91)	<b>\$925.00</b>
Full track, 15 and 7½ ips, rack mounted.		
<b>Part No. 099 0374 00</b>	(Type 92)	<b>\$925.00</b>
Half track, 15 and 7½ ips, rack mounted.		
<b>Part No. 099 0375 00</b>	(Type 93)	<b>\$1,175.00</b>
Two track stereo, rack mounted.		
<b>Part No. 099 0376 00</b>	(Type 93-4)	<b>\$1,175.00</b>
Four track stereo, rack mounted.		
<b>No Part Number</b>	<b>No Charge</b>	
Factory installed conversion kit to 3¾ and 7½ ips. Specify "A" following model number.		
<b>No Part Number</b>	<b>\$35.00</b>	
Factory installed conversion kit for 50 cps operation. Specify "50 cps" following model number.		
<b>Part No. 099 0377 00</b>		<b>\$65.00</b>
Extra playback head, two track or four track stereo head, factory installed.		
<b>Part No. 099 0378 00</b>		<b>\$195.00</b>
Complete stereo head assembly. Four heads (erase, record, play, play) two or four track stereo. Factory installed.		
<b>Part No. 099 0379 00</b>	(Type 700105)	<b>\$29.95</b>
Transformer, 50-ohm microphone, input.		
<b>Part No. 099 0380 00</b>	(Type 700106)	<b>\$29.95</b>
Transformer, 250-ohm microphone, input.		
<b>Part No. 099 0381 00</b>	(Type 700107)	<b>\$29.95</b>
Transformer, 10,000-ohm line-level, input.		
<b>Part No. 099 0382 00</b>	(Type 700108)	<b>\$29.95</b>
Transformer, 600-ohm line-level, input.		
<b>Part No. 099 0383 00</b>	(Type 700122)	<b>\$60.00</b>
Portable case (for transport or two preamplifiers).		
<b>Part No. 099 0384 00</b>	(Type 700133)	<b>\$30.00</b>
*Portable case (for one preamplifier).		
<b>Part No. 099 0385 00</b>	(Type 700120)	<b>\$59.95</b>
Remote control with 25 ft. cord.		

## COLLINS TT-400/200 TURNTABLES



Collins Turntables feature a simplicity of design which requires only three moving parts in the drive mechanism. There is no complicated linkage system to break down or to add to wow or rumble.

The turntables are constructed of heavy cast aluminum with a blue-gray wrinkle finish. The turntables are non-magnetic. A gear speed shift offers selection of 33, 45 and 78 rpm, with neutral between slots. An indentation in the turntable eliminates the need for a spindle adapter for 7" 45 rpm records.

The tables are rim-driven by a single molded neoprene idler wheel. The idler wheel serves only to transfer power to the rim. It does not determine the speed of the table. Normal wear and reduction of the idler wheel have no effect on the precision of the platter speed.

*Noise Level (based on reference level of 7 cm/sec., at 1,000 cps):*

Speed	16" TT-400	12" TT-200
33⅓	-48 db	-49 db
45	-47 db	-49 db
78	-42 db	-46 db

*Speed Acceleration:*

Speed	16" TT-400	12" TT-200
33⅓	1/10 revolution	1/16 revolution
45	1/8 revolution	1/12 revolution
78	1/2 revolution	1/3 revolution

*Models:*

TT-400	— 16", 4-pole motor
TT-400S	— 16", synchronous motor
TT-450S	— 16", synchronous motor, 50 cps
TT-200	— 12", 4-pole motor
TT-200S	— 12", synchronous motor
TT-250S	— 12", synchronous motor, 50 cps

*Size:* TT-400 and TT-400S — 2" above base plate, 6" below base plate, over-all base 19⅝" square.

TT-200 — 1½" above table, 4¼" below table, base 15⅜" W, 14½" D.

TT-200S — Same as TT-200, except 6" below table.

*Weight:* TT-400 — 53 lbs. TT-200 — 22 lbs.

<b>Part No. 097 3736 00</b>	(Type TT-400)	<b>\$199.50</b>
<b>Part No. 097 3737 00</b>	(Type TT-400S)	<b>\$235.00</b>
<b>Part No. 097 6286 00</b>	(Type TT-450S)	<b>\$245.00</b>
<b>Part No. 097 3971 00</b>	(Type TT-200)	<b>\$110.00</b>
<b>Part No. 097 3811 00</b>	(Type TT-200S)	<b>\$147.50</b>
<b>Part No. 097 6285 00</b>	(Type TT-250S)	<b>\$157.50</b>
<b>Part No. 097 8123 00</b>		<b>\$3.50</b>
Rubber pad to fill turntable indentation for TT-400/200 series. Allows playing small hole 33⅓ rpm records.		
<b>Part No. 097 7253 00</b>		<b>\$8.80</b>
220 v to 115 v step-down transformer. 150 watts, for use with TT-400/200 turntables.		



# RECORDING

## COLLINS TURNTABLE CABINET

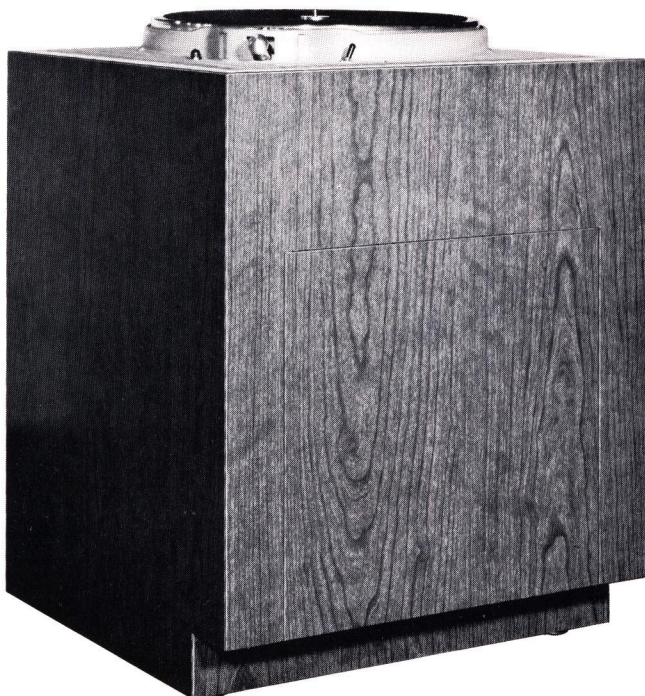

Has front door for accessibility to turntable components. Cutout on top for one Collins TT-400 or TT-200 Series Turntable. Cabinet finished in Kashmir walnut Formica. Other coverings available on special order. Specify turntable model number. *Size:* 24" W, 30" H, 24" D.

Part No. 097 6131 00 (Type TCFW-2) \$90.00  
For use with TT-200 series turntables.  
Part No. 097 6225 00 (Type TCFW-4) \$90.00  
For use with TT-400 series turntables.

## COLLINS 356H-1 PHONO EQUALIZER PREAMP

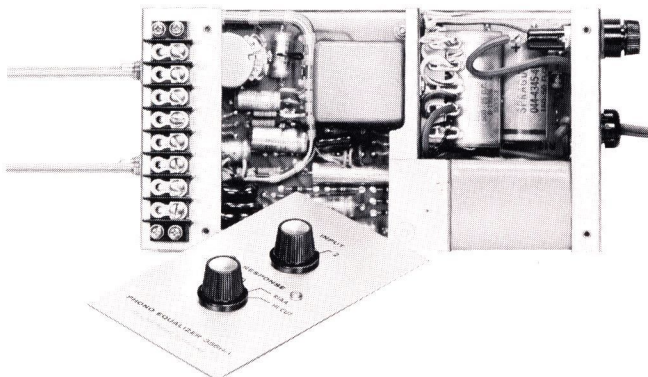

An economical unit to equalize and amplify the output signal of a magnetic phono cartridge, this small transistorized unit is used to replace passive equalizers and console or turntable preamplifiers. The housing of the unit is constructed of steel for magnetic shielding.

Control shafts are 3" long and may be cut to proper

length after mounting the unit in the cabinet. The 356H-1 provides choices between two inputs and between four response curves: (1) Flat, for test purposes, and mike preamp use; (2) Hi-Boost, which has a 4 db rise above normal at 15,000 cps; (3) Normal, which is the RIAA equalizing curve, and (4) Hi-Cut, which has a 4 db drop below the Normal curve at 15,000 cps.

*Frequency Range:* 30-15,000 cps, (Typical — "Flat" position  $\pm 1.5$  db, 20-20,000 cps). *Frequency Response:*  $\pm 1.5$  db from RIAA playback equalization response curve. *Output Level:* -10 dbm,  $\pm 3$  db with -50 dbm input at 1,000 cps. *Output Impedance:* 150/600 ohms, balanced or unbalanced. *Input Impedance:* High impedance bridging, unbalanced. *Distortion:* 1.0% maximum, 30-15,000 cps at -10 dbm output. *Output Noise:* Signal-to-noise ratio 60 db.

*Gain:* 40 db at 1000 cps minimum. *Power Source:* 120/240 v ac,  $\pm 5\%$ , 50/60 cps. *Size:* 4" W, 2" H, 7 $\frac{3}{4}$ " D. *Weight:* 5 lbs.

Part No. 522 2468 00

\$115.00

## GRAY 602C EQUALIZER

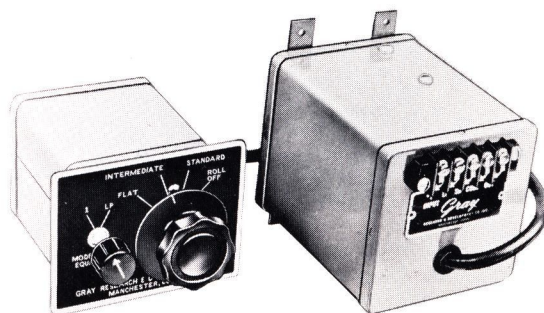

Normally used with standard microphone preamplifiers, making it unnecessary to purchase special audio input equipment when using magnetic cartridges. A convenient control permits instantaneous input switching from conventional records to microgroove. *Output Impedance:* 250 ohms balanced (150 or 50 ohms available). *Insertion Loss:* 20 db. *Output Level:* -67 VU at 4.7 cm/second. *Cable Length:* 18".

Part No. 272 1438 00

\$57.50

## GRAY 212-TN PLAYBACK ARM



A slide-in cartridge is used to allow instant change from standard groove to microgroove. The arm will accommodate all popular magnetic pickup cartridges, including Pickering, G. E., and Fairchild. Available for 12" (212-TN) recordings.

Part No. 099 0386 00

(Type 212-TN)

\$35.50



## GRAY 208 SERIES PLAYBACK ARMS

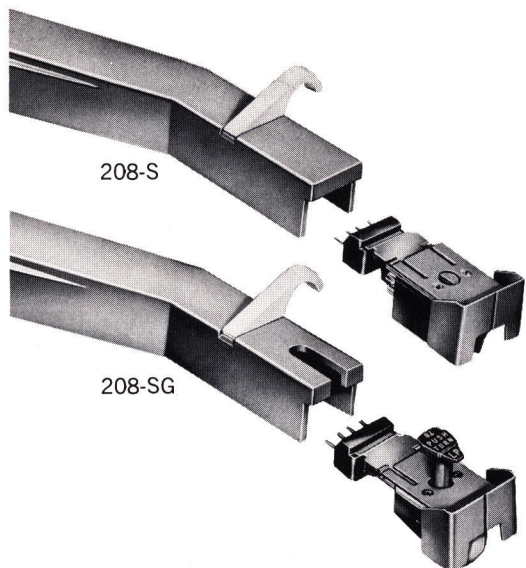

The Gray professional stereo tone arm is available in two models that are identical in performance. Model 208-S comes with a slide and modular weights for mounting single play stereo or monophonic cartridges. Model 208-SG has a special slot cut into the front of the tone arm to clear the stem of a G. E. turnaround cartridge allowing plug-in operation and comes with specific hardware for this application.

Accessory slide kits are available for multiple cartridge operation.

The 8-S accessory slide assembly includes the cartridge slide, modular weights, mounting hardware and compressible spacers for the installation of stereo or monophonic single play cartridges. The 8-S slide assembly with cartridge mounted is usable in either the 208-S or 208-SG interchangeably.

The 8-SG accessory slide assembly is specifically designed to mount the G. E. turnaround cartridge. With this cartridge installed, it will only fit the 208-SG arm; however, cartridges are interchangeable between arms in this model.

*Response:*  $\pm 1$  db from 5 cps to top end limit imposed by cartridge used. *Size:*  $2\frac{1}{8}$ " W,  $2\frac{5}{8}$ " H, 15" L. *Weight:* 2 lbs.

Part No. 099 0387 00 (Type 208-S) \$49.50  
Part No. 099 0164 00 (Type 208-SG) \$49.50

## REK-O-KUT PLAYBACK ARMS

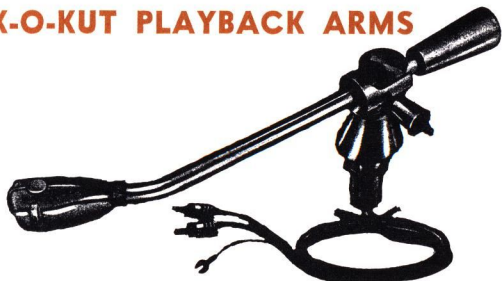

Tubular arm body with die cast aluminum cartridge shell and counterweight. Four-conductor lead accommodates all 3- and 4-wire stereo cartridges. Does not include but uses all standard cartridges. Available for either 16" (S-260) or 12" (S-320) recordings.

Part No. 099 0242 00 (Type S-260) \$34.95  
Part No. 099 0241 00 (Type S-320) \$32.95

## SHURE PLAYBACK ARMS



Accepts stereo and monophonic cartridges. Arm features precision ball bearings at all pivot points, plug-in head with positive alignment lock and variable adjustment. Supplied with arm rest, mounting template, mounting hardware and 4-foot cable assembly. *Size and Weight:* 12" arm (M232), 12 $\frac{1}{8}$ " L, 1 lb.; 16" arm (M236), 14 $\frac{1}{2}$ " L, 1 $\frac{1}{8}$  lbs.

Part No. 097 8118 00 (Type M232) \$29.95  
Part No. 097 8122 00 (Type M236) \$31.95

## GENERAL ELECTRIC CARTRIDGES AND STYLI

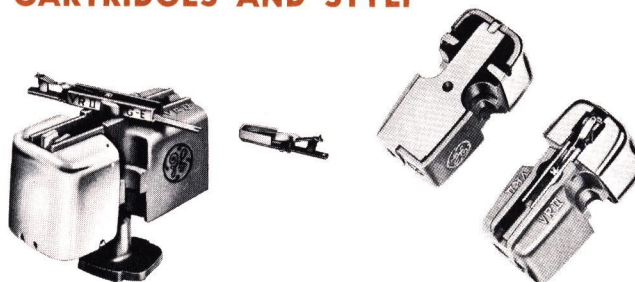

4GS-01D — Cartridge with 1 mil diamond stylus.

4GS-02D — Cartridge with 2.5 mil diamond stylus.

4GS-01S — Cartridge with 1 mil sapphire stylus.

4GS-02S — Cartridge with 2.5 mil sapphire stylus.

4GD-01D-02S — Cartridge with 1 mil diamond and 2.5 mil sapphire styli.

4GD-01D-02D — Cartridge with 1 and 2.5 mil diamond styli.

4GD-01S-02S — Cartridge with 1 and 2.5 mil sapphire styli.

4G-01D — 1 mil Diamond Stylus (above cartridges only).

4G-02D — 2.5 mil Diamond Stylus (above cartridges only).

4G-01S — 1 mil Sapphire Stylus (above cartridges only).

4G-02S — 2.5 mil Sapphire Stylus (above cartridges only).

Part No. 097 3844 00 (Type 4GS-01D) \$20.50  
Part No. 097 3845 00 (Type 4GS-02D) \$20.50  
Part No. 097 3846 00 (Type 4GS-01S) \$10.50  
Part No. 097 3847 00 (Type 4GS-02S) \$10.50  
Part No. 097 3848 00 (Type 4GD-01D-02S) \$22.50  
Part No. 097 3849 00 (Type 4GD-01D-02D) \$33.50  
Part No. 097 3850 00 (Type 4GD-01S-02S) \$12.95  
Part No. 097 3853 00 (Type 4G-01D) \$9.95  
Part No. 097 3854 00 (Type 4G-02D) \$9.95  
Part No. 097 3851 00 (Type 4G-01S) \$2.00  
Part No. 097 3852 00 (Type 4G-02S) \$2.00



# REMOTE



## COLLINS 808A-1 REMOTE TURNTABLE-CONSOLE

A compact, completely transistorized portable unit, the three-channel 808A-1 is designed for quick, easy, high fidelity program origination in remote broadcasting. Ideal for promotion-type shows, the turntable-console offers complete facilities to feed program material into a telephone line to the broadcast station. The unit also will allow independent control of public address facilities and can be used to drive a remote amplifier such as the Collins 212H-1.

The 808A-1 is especially suited for combination work in a small announce booth; for schools where an economical unit but complete facilities are needed; for use in conjunction with sound systems; and for standby studio facilities at the transmitter site in case of breakdown between the studio and transmitter.

The 808A-1 eliminates the need for multiple equipments. Once on location, the unit can be plugged in, connected to a remote line and it is ready for use. It can simultaneously combine the two self-contained turntable outputs with any one of three remote inputs. Built-in phono equalization meets RIAA standards. A VU meter indicates program level, and a headphone jack is provided for program monitoring. Line terminals and microphone jacks are located on the back of the unit.

A bottom dust cover, easily removed, protects the lower portions of the turntables, cabling and amplifiers. The preamplifiers attach to the control panel, which is

removable as a unit for servicing. Legs are detachable and self-storing beneath the unit. The sturdy, modern-looking cabinet is made of steel with a white and gray baked enamel finish. The panel and trim strips are brushed aluminum.

Controls on the panel include the following: an external input selector switch, which will select one of the external outputs of Mike 1, Mike 2 or NEMO; motor power switches which energize the turntable motors; three cue switches which are gauged to the fader control; three separate fader controls for the three inputs; master gain, which controls the over-all output signal; ac power switch, which is gauged to the public address gain; public address gain, which allows independent adjustment of the public address or other remote systems; headphone gain; and turntable shift levers for selection of proper turntable speed of 33, 45 or 78 rpm.

The remote amplifier, made up of six low level modules and one line amplifier module, uses eight General Electric 1175A low noise transistors and two Motorola 651 push-pull Class A-B transistors. Bias is stabilized over a wide temperature range by the use of a germanium diode. The turntable preamplifiers conform to NAB and RIAA specifications and feature a feedback design which offers a consistently stable performance.

Two Collins TT-200 Turntables with Rek-O-Kut



S-320 pickup arms and General Electric sapphire cartridges are furnished with the 808A-1. Specially designed for radio broadcast use, Collins Turntables maintain 99.95% accurate speed and have negligible wow and flutter. They are mounted on a strong cast aluminum base, and precision machining is used throughout.

**Frequency Response:** ±2 db, 50-15,000 cps with 1,000 cps reference. **Gain:** 100 db minimum on mike input. **Balanced Inputs:** Mikes 1 and 2, 50-600 ohms, -55 dbm nominal. NEMO input 600 ohms, 0 dbm nominal. **Noise:** Signal-to-noise ratio, 55 db. **Distortion:** 2% maximum, 50-15,000 cps at +18 dbm. **Power Output:** +18 dbm (+8 VU) into 600 ohm program line. Adjustable, high impedance public address output. **Power Source:** 120 v ac, ±10%, 60 cps, 1 phase. **Size:** 33½" W, 33" H (with legs), 20½" D. **Weight:** 78 lbs.

Part No. 522 2609 00

\$825.00

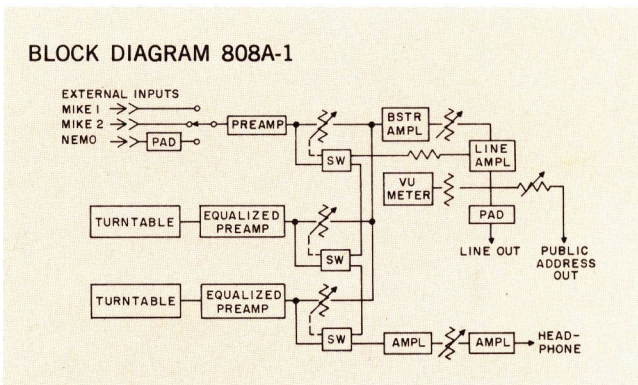

**COLLINS 212H-1 REMOTE AMPLIFIER**

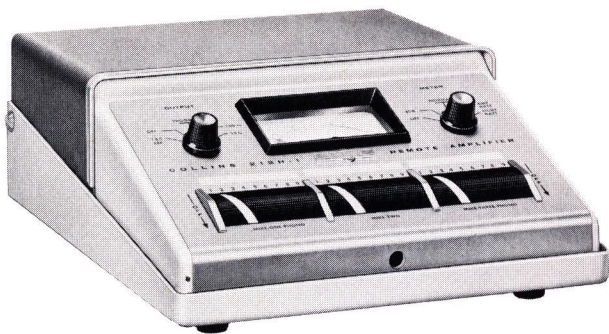

The only one of its kind on the market with so many advanced and deluxe features, the Collins 212H-1 is a three channel remote amplifier that provides adequate facilities for most remote applications.

The 212H-1 is transistorized throughout and is built into a highly punishable thermoplastic and vinyl-clad aluminum case. A handle is mounted on the rear chassis to allow quick and easy handling between remote locations. A snap-on cover of durable thermoplastic protects the panel, controls and VU meter.

The unit is completely self-contained and operates from fourteen 1.5 volt flashlight batteries. These batteries supply power to the amplifier for about 200 hours. The supply is interlocked with the headphone jack so

that the unit requires headphones to be plugged in before it becomes operational. The VU meter indicates remaining battery voltage.

A built-in phono equalizer on two of three channels provides instantaneous switching between two phonos and a microphone, or between three microphones. A built-in multiple tone generator allows a quick response check of the remote line or provides a standby tone of 100, 1000 or 5000 cps. Sure-grip thumb wheels 2¼" wide indicate volume input control by a diagonally moving white stripe.

**Frequency Response:** ±3 db 50-15,000 cps (1000 cps reference at +8 dbm output).

**Gain:** 90 db nominal on mike input.

**Output:** Line — Normal, +8 VU (+18 dbm) into 600 ohms; Low, 0 VU (+10 dbm) into 600 ohms; Bridge — -40 dbm into 250 ohms.

**Power Source:** Self-contained batteries — twelve 1.5 v flashlight batteries for amplifier and two 1.5 v batteries for meter light.

**Distortion:** 2% maximum 50-15,000 cps +18 dbm output.

**Noise:** -115 dbm equivalent input noise or less (-55 dbm input, -60 db noise).

**Inputs:**

- One:
  - a. Unbalanced mike.
  - b. Phono, equalized for magnetic cartridge.
- Two:
  - a. Low impedance balanced mike.
  - b. Self-contained tone generator.
- Three:
  - a. Unbalanced mike.
  - b. Phono, equalized for magnetic cartridge.

**Output Connectors:**

- a. Program line, binding terminal posts.
- b. Bridge feed, male Cannon connector.
- c. Program monitor, headphone jack.

**Ambient Temperature Range:** -20°C to +50°C (-4°F to +122°F).

**Ambient Humidity Range:** Up to 95%.

**Size:** 10" W, 4½" H, 12" D.

**Weight:** 11 lbs.

**Color:** Green, white and gray.

Part No. 522 2419 00  
Includes batteries.

\$375.00

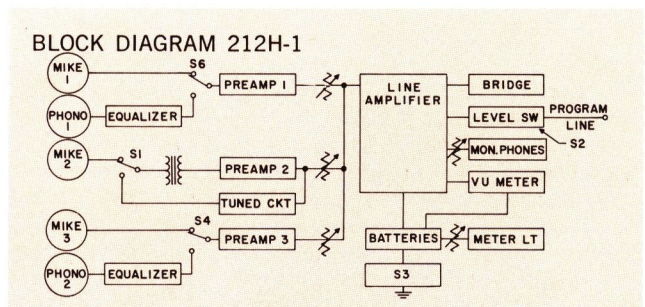



# REMOTE

## COLLINS 212Z-1 REMOTE AMPLIFIER



Weighing a total of 22 pounds including batteries and carrying case, the 212Z-1 offers full functions for remote broadcasts. This transistorized remote amplifier mixes inputs from up to four microphones, with program line and communication line outputs as well as an auxiliary output for PA feed.

A power source of both 115 v ac and batteries assures uninterrupted service. Should the ac power fail, an automatic changeover switches the 212Z-1 to battery power and reverts when ac power is restored. A light on the panel indicates when the 212Z-1 operates on ac power. The self-contained batteries have a long life of about 75 hours.

The Collins 212Z-1 is attractively styled — yet rugged and convenient to use. Housed in a Royalite carrying case, the 212Z-1 securely fastens to the bottom of the case. The 212Z-1 has a black and metallic blue-gray abrasion-resistant finish.

The four channel mixing circuit incorporated in the amplifier is designed to work with all microphones having a 30 to 600 ohm impedance. The output circuit matches a 600 ohm line. Provisions are made for two program lines and a telephone through the output switch.

Although simultaneous program feed and communication cannot take place over a single line at the same time, the output switch allows rapid interchange between communication and the amplifier output on the same line.

The power supply is a shielded, full-wave unit with germanium diodes and multi-section filtering. A power interlock switch insures no battery drain when the unit is in its closed carrying case.

The Collins 212Z-1 Remote Amplifier is completely transistorized throughout. The tone oscillator, preamplifiers and interstage amplifiers use 2N422 hermetically-sealed low noise transistors. The driver employs a 2N465 transistor. The output amplifier, with transformer coupling on the input and output sides, has push-pull 2N44 transistors.

Since line levels are most easily set up by means of a steady audio tone, the 212Z-1 includes a built-in audio tone oscillator as a standard feature.

One or two headphones may be plugged into the monitor jacks. Where loudspeaker monitoring or feed for local public address is desired, the PA terminals are used. An isolated PA feed and an individual gain control allow the operator to handle the program and simultaneously ride gain on the PA system. A multiple jack on the side permits two units to be used simultaneously and controlled by one master gain control.

*Frequency Response:* ±1.5 db 50-15,000 cps.

*Input:* 4 channels selected by Daven step-type attenuators numbered to correspond with input plugs.

*Input Impedance:* 30-600 ohms.

*Gain:* 90 db maximum.

*Noise Level:* 55 db below normal output level.

*Distortion:* Less than 1½% at +5 dbm.

*Power Output:* Normal +11 dbm; emergency +16 dbm.

*Output Impedance:* 600 ohms (150 ohms available).

*Power Source:* 115 v or 230 v ac 50/60 cps or self-contained batteries, such as one 4.5 v Burgess D-3 or Eveready 726, and two 22.5 v Eveready 763. Life of 22.5 v battery is approximately 75 hours; 4.5 v approximately 90 hours. (Batteries not supplied with unit.)

*Microphone Connections:* 4 Cannon XL-3-13N, P-3-13, Hubbell 7557, Cannon UA-3-13 or UA-3-14 available at additional cost.

*Ambient Temperature Range:* 0°-45° C.

*Ambient Humidity Range:* Up to 95%.

*Size:* 15½" W, 6½" H, 14½" D.

*Weight:* 22 lbs. (with batteries).

<b>Part No. 522 0330 003</b> 212Z-1 without batteries.	<b>\$595.00</b>
<b>Part No. 015 0520 00</b> (Type 763) Two batteries required in addition to one Type 726 battery (below).	<b>\$1.64 each</b>
<b>Part No. 015 0519 00</b> (Type 726) One battery required in addition to two Type 763 batteries (above).	<b>\$.97 each</b>
<b>Part No. 522 0330 043</b> Cannon P-3-13 connectors for 212Z-1.	<b>\$15.00</b>
<b>Part No. 522 0330 063</b> Hubbell 7557 connectors for 212Z-1.	<b>\$15.00</b>
<b>Part No. 522 0330 033</b> Cannon UA-3-13 connectors for 212Z-1.	<b>\$15.00</b>

BLOCK DIAGRAM 212Z-1

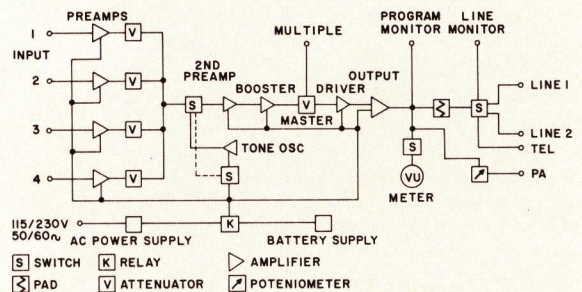



## MARTI REMOTE PICK-UP EQUIPMENT

Sold exclusively by Collins Radio Company and designed for program origination away from broadcast studios, the Marti Remote Transmitter and Receiver provide quality transmission of sports, spot news reports and interviews on frequencies assigned for exclusive use by broadcasters. The unit is compact and light enough to be carried into stadiums and press boxes as easily as a multi-channel remote amplifier.

The audio quality of the Marti for music or voice transmission is guaranteed to be equal to or better than lines with coverage up to 40 miles radius depending upon the type and location of the transmitting and receiving antennas. The Marti Receiver is equipped with an automatic relay that operates an alarm system in the station to indicate a forthcoming broadcast.

The unit may legally be used instead of lines even where lines are available. Many stations, after installing the Marti system, have standing sponsorship of all their remote programs and have actually paid for the equipment in savings on line charges alone. The equipment also opens new program possibilities that are overlooked because of inconvenience in using other, cumbersome and less reliable means.

The Marti Transmitter is operated either by ac or batteries. Designed for continuous duty, the equipment meets the most stringent FCC requirements regarding bandwidth.

It is easily portable and lightweight and does not require frequent tuning. The transmitter and transistorized power supply and associated equipment are easily installed in a car for permanent and immediate use.

### M-3-60B TRANSMITTER



*RF Output:* 15 watts.

*Frequency:* 152-172 mc.

*Crystal Multiplication:* 36.

*Spurious Emission:* Attenuated 90 db. Harmonics suppressed 65 db or more.

*Frequency Stability:*  $\pm 0.0005\%$  with crystal oven.

*Modulation:* 25 F3 maximum (normally adjusted for  $\pm 10$  kc swing).

*Audio Inputs:* Two adjustable for 50, 150, 250, or 600 ohms input.

*Audio Input Level:* -70 db.

*Modulation Control:* Push-pull limiter.

*Noise Level:* Better than -45 db.

*Over-all Response with Matched Receiver:*  $\pm 3$  db, 75-7,500 cps.

*Distortion:* Less than 3%.

*Temperature Range:* -40° C to +70° C.

*Power Requirements:* 117 v ac, 140 watts.

*Size:* 14" W, 7" H, 10" D.

*Weight:* 16 lbs.

<b>Part No. 099 0550</b>	(Type M-3-60B) Includes 117 v ac power supply.	<b>\$545.00</b>
<b>Part No. 099 0551</b>	(Type M-3-60B/TPS) Same as M-3-60B but with a 12.6 v transistorized power supply on the same chassis and a 117 v power supply.	<b>\$590.00</b>
<b>Part No. 099 0552</b>	(Type M-3-60C) Communications-quality 25-watt base transmitter with a frequency range of 152-172 mc. For 117 v ac operation.	<b>\$300.00</b>
<b>Part No. 099 0553</b>	(Type M-3-60C/11RS-2Q) Complete base station of communications-quality and a broadcast-quality remote pick-up receiver on the same chassis. Frequency range of 152-172 mc. For 117 v ac operation.	<b>\$600.00</b>
<b>Part No. 099 0554</b>	(Type XT-1) Crystal for M-3-60B transmitter.	<b>\$8.50</b>
<b>Part No. 099 0555</b>	(Type DFT) Dual frequency kit for M-3-60B transmitter, less crystal.	<b>\$25.00</b>
<b>Part No. 099 0556</b>	(Type DF-RMC) Dual frequency kit for M-3-60C/11RS-2Q.	<b>\$20.00</b>

### 11RS-2Q RECEIVER

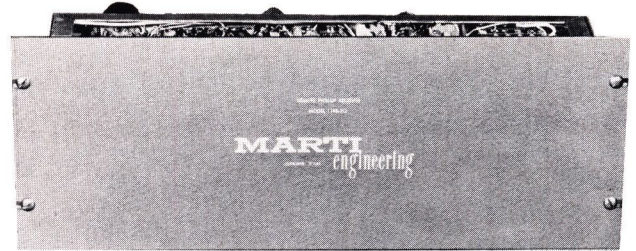

*Sensitivity:* 0.6 mv or less for 20 db quieting.

*Frequency Range:* 150-174 mc.

*Selectivity:* -100 db at  $\pm 30$  kc; -6 db or less at  $\pm 15$  kc.

*Spurious Response:* Attenuated at least 100 db.

*Frequency Stability:*  $\pm 0.0005\%$  with crystal oven.

*Audio Output:* +4 VU at 600 ohms.

*Temperature Range:* -40° C to +70° C.

*Size:* 17" W, 6" H, 3 $\frac{3}{8}$ " D.

<b>Part No. 097 6630</b>	(Type 11RS-2Q)	<b>\$350.00</b>
<b>Part No. 099 0557</b>	(Type RA-150) 12.6 v mobile receiver, communications-quality. To mate with M-3-60B/TPS and TPS-TC for complete two-way communication with an M-3-60C/11RS-2Q base station.	<b>\$150.00</b>
<b>Part No. 099 0553</b>	(Type M-3-60C/11RS-2Q) Complete base station of communications-quality and a broadcast-quality remote pick-up receiver on the same chassis. Frequency range of 152-172 mc. For 117 v ac operation.	<b>\$600.00</b>
<b>Part No. 099 0466</b>	(Type XR-1) Crystal for 11RS-2Q receiver or RA-150 receiver.	<b>\$14.00</b>
<b>Part No. 099 0465</b>	(Type DFT) Dual frequency kit for 11RS-2Q receiver, less crystal.	<b>\$25.00</b>
<b>Part No. 099 0556</b>	(Type DF-RMC) Dual frequency kit for M-3-60C/11RS-2Q.	<b>\$20.00</b>



# REMOTE

## TPS-1 POWER SUPPLY

*Input Voltage:* 12-16 v dc.

*Current:* Standby — 6 amps; transmit — 13 amps.

*Outputs:* 6.3 v, 6 amps (regulated). 330 v ac to the rectifier system.

*Duty Cycle:* Continuous.

*Efficiency:* Approximately 85%.

*Size:* 17" W, 6" H, 3 3/8" D.

*Weight:* 7 1/2 lbs.

Part No. 097 6653 00 (Type TPS-1) \$89.50

## MARTI REMOTE EQUIPMENT ACCESSORIES

**MOBILE ASSEMBLAGE** — Consists of control unit, all battery and control cables and mounting rack for the M-3-60B/TPS transmitter (Type TPS-TC).

Part No. 099 0541 00 \$35.00

**REMOTE CONTROL CONSOLETTTE** — For use with M-3-60C or M-3-60C/11RS-2Q (Type RMC-1).

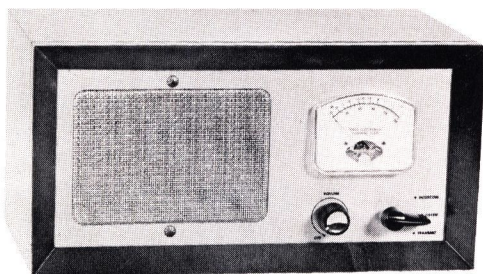

Constructed of wood cabinet and aluminum anodized front panel, complete with VU meter. *Size:* 14" W, 9" H, 10" D.

Part No. 099 0542 00 \$117.50

The following antennas are tuned or cut to frequency with a standing wave ratio of less than 1.5:1 and are designed for 50-52 ohm transmission lines.

**SINGLE RING ANTENNA** — Essentially non-directional, horizontally polarized and unity gain.

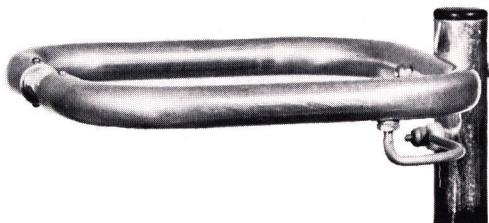

Specify whether for portable (PA-1) or mobile (MA-1) use.

Part-No. 097 6952 (Type PA-1) \$17.50  
Part No. 097 6953 (Type MA-1) \$17.50

**TWO RING ANTENNA** — Essentially non-directional, horizontally polarized. Has a gain of 3 db (Type RA-2).

Part No. 099 0543 \$60.00

**ANTENNA BUMPER MOUNT** — Chain link bumper mount (Type ASP-143) for use with mobile antenna.

Part No. 097 6880 00 \$7.95

**FOUR RING ANTENNA** — Essentially non-directional, horizontally polarized. Has a gain of 6 db and power gain of 4. *Impedance:* 52 ohms. *Weight:* 11 lbs.

Part No. 097 6950 \$131.75

**FIVE ELEMENT YAGI ANTENNA** — Uni-directional antenna. *Nominal Impedance:* 50 ohms.



*Average Gain:* 9 db. *Typical VSWR:* Under 1.5. *Typical Rear Signal Rejection:* 25 db. *Power Handling Capacity:* 60 watts. *Input Connector:* Type AN-SO-239 (Amphenol Type 83-1R). *Polarization:* Horizontal or vertical.

Part No. 099 0177 \$25.00

**COAXIAL STACKING HARNESS** — Required for stacking two, five element Yagi antennas. It is made up of two sections of RG-11/U 75 ohm coaxial cable joined at the center by a coaxial "T" fitting. Each "half" of the phasing harness is an odd multiple of a quarter wave length and by virtue of its characteristic impedance and length, steps the 50 ohm antenna impedance to 100 ohms. When the two cables are joined at the "T" connector, the impedance again becomes 50 ohms (Type 2YC).

Part No. 099 0190 \$11.25

**KREKO VERTICALLY POLARIZED ANTENNA** — This vertically polarized base antenna has a gain of 6 db (Type SC-155-B).

Part No. 099 0544 \$112.50

**VEHICLE ROOFTOP ANTENNA** — Designed especially for mounting on a vehicle, this antenna has a 3 db gain (Type ASP-177).

Part No. 099 0545 \$24.00

**COAXIAL CABLE AND CONNECTORS** — The following coaxial cables and connectors may be used with the Marti Remote Pick-Up Equipment:

Part No. 099 0146 \$13.00  
RG 8/U coaxial cable, 100'.  
Part No. 099 0137 \$60.00  
RG 17/U coaxial cable, 100'.  
Part No. 099 0546 00 \$ .75  
RG 8/U connector PL-259 (Type 83-1SP).  
Part No. 099 0547 00 \$1.20  
RG 8/U straight adapter PL-258 (Type 83-1J).  
Part No. 099 0548 00 \$9.50  
RG 17/U to RG 8/U connector (Type GR-6355).  
Part No. 097 7023 \$100.00  
RG 253/U Spir-O-line cable, 1/2", polyethylene jacketed, 100'.  
Part No. 099 0549 00 \$13.00  
Spir-O-line RG 253/U to PL-258 connector (Type 87-500).



# MICROPHONES

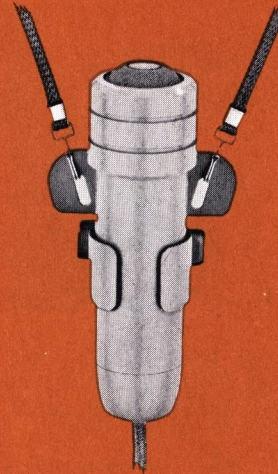
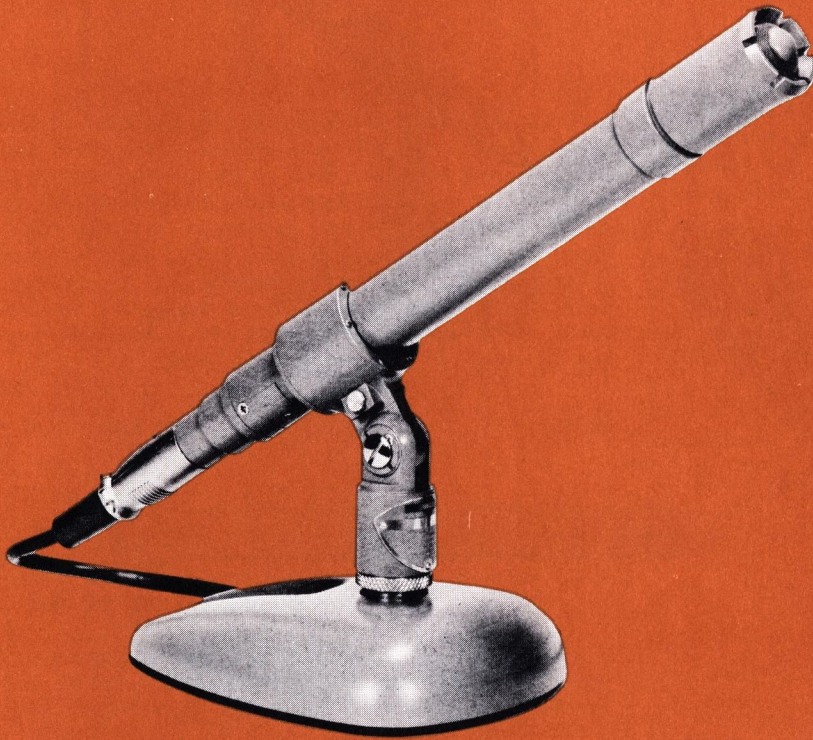

## COLLINS M-100 MICROPHONE

Gives a flexibility unequaled by any other microphone in its price range. Its response is smooth and uniform from 40 to 20,000 cps, but it may be adjusted for varying audio conditions when used by the soprano or the low-voiced sportscaster, or on exceptionally difficult remote broadcasts. Simple screwdriver adjustments allow a low frequency cutoff at 40, 80 or 160 cps, and a high frequency cutoff at 10,000 or 20,000 cps.

The Collins M-100 is a dynamic, omnidirectional microphone that may be used with any amplifiers having a 35-80 ohm or 150-250 ohm input. Includes 20 ft. of cable and desk stand with grip cam-lock to allow easy removal from the stand without disconnecting.

*Impedance:* 50 ohms or 200 ohms, selectable. *Frequency Response:* 40-20,000 cps. *Output Level:* -62 db, with reference to 1 mw/10 dynes/cm<sup>2</sup>. *Size:* 10½" long, 1" diameter. *Weight:* 9½ oz. *Color:* Non-reflecting blue-gray.

Part No. 099 0078 00

\$115.00

## COLLINS M-20 MICROPHONE

This small and rugged lavalier microphone frees hands in one-man speaking situation such as weather shows and demonstrations. It is small enough to be hidden behind a necktie or lapel. Supplied with lavalier clip and 25 ft. of 3-conductor cable. Essentially omnidirectional polar pattern. Desk stand available on order.

*Impedance:* 50 ohms or 200 ohms, selectable. *Frequency Response:* 60-18,000 cps. *Output Level:* -57 db, with reference to 1 mw/10 dynes/cm<sup>2</sup>. *Size:* 4" long, 1" diameter. *Weight:* 3½ oz. *Color:* Non-reflecting blue-gray.

Part No. 097 5464 00

\$36.00

Part No. 097 6627 00

\$3.00

Replacement lavalier clip for M-20.

Part No. 097 5826 00

\$3.50

Desk stand for M-20.

If You Didn't Get This From My Site,  
Then It Was Stolen From...

[www.SteamPoweredRadio.Com](http://www.SteamPoweredRadio.Com)



# MICROPHONES



M-30



M-40



M-50



M-60

## COLLINS M-60 REMOTE MICROPHONE-AMPLIFIER

This completely self-contained unit combines a one channel remote amplifier and a high quality omnidirectional microphone. The amplifier has six plug-in transistors which are powered by a 5.4 v mercury cell having a 50-hour life expectancy. Includes earplug headphone.

*Amplifier Output:* +12 dbm at 2% or less distortion. *Frequency Response:*  $\pm 1.5$  db 60-15,000 cps. *Relative Noise at Amplifier Input:* -119 dbm. *Size:* 12 $\frac{3}{4}$ " long, 1" diameter. *Weight:* 18 oz. *Color:* Non-reflecting blue-gray.

Part No. 097 5779 00

\$225.00

## COLLINS M-30 MICROPHONE

Assures high fidelity reproduction of both voice and music to meet professional and quality public address system requirements. Includes stand and 12 ft. cable. Essentially omnidirectional polar pattern.

*Impedance:* 50 ohms or 200 ohms, selectable. *Frequency Response:* 50-15,000 cps. *Output Level:* -59 db, with reference to 1 mw/10 dynes/cm<sup>2</sup>. *Size:* 6 $\frac{5}{8}$ " long, 1 $\frac{3}{4}$ " diameter. *Weight:* 16 oz. with stand. *Color:* Non-reflecting blue-gray.

Part No. 097 6647 00

\$48.50

## COLLINS M-40 MICROPHONE

Ideal for panel discussions, dinner meetings and interviews. Equipped with desk stand and 20 ft. of three-conductor, plastic jacketed cable. Essentially omnidirectional polar pattern.

*Impedance:* 50 ohms or 200 ohms, selectable. *Frequency Response:* 40-20,000 cps. *Output Level:* -59 db, with reference to 1 mw/10 dynes/cm<sup>2</sup>. *Size:* 9 $\frac{5}{8}$ " long, 1" diameter. *Weight:* 11 oz. *Color:* Non-reflecting blue-gray.

Part No. 097 5463 00

\$72.50

## COLLINS M-50 MICROPHONE

Provides highly directional sound selectivity to double conventional working distance and cut out unwanted sounds. Eliminates booms and pops, but gives accurate, natural pickup of voice and music. Desk or floor stand available on order.

*Impedance:* 50 ohms or 200 ohms, selectable. *Frequency Response:* 40-15,000 cps. *Output Level:* -55 db, with reference to 1 mw/10 dynes/cm<sup>2</sup>. *Size:* 7 $\frac{1}{4}$ " long, 1 $\frac{7}{8}$ " diameter. *Weight:* 1 lb., 10 oz. (without cable). *Color:* Non-reflecting blue-gray.

Part No. 097 7569 00

\$62.50



## ELECTRO-VOICE 666 CAROID MICROPHONE



This microphone provides high discrimination against sounds from back hemisphere. Permits close talking with no bass accentuation and increases working distance over pressure microphones by factor of 1.7:1 due to polar pattern. Clamp-on stand mount with  $\frac{5}{8}$ "-27 thread,  $\frac{1}{2}$ " pipe thread adapter and 20' cable included.

*Impedance:* Changeable on internal terminal board. Wired for 150 ohms, taps at 50 and 250 ohms. *Frequency Response:* 30-16,000 cps. *Output Level:* -55 db. *Size:* 7 $\frac{1}{2}$ " long, 1 $\frac{3}{4}$ " diameter. *Weight:* 11 oz. *Color:* Gray.

Part No. 097 3036 00

\$153.00

## ELECTRO-VOICE 665 CAROID MICROPHONE

Similar in design and function to the Electro-Voice 666, but for less exacting applications. Includes 18' cable.

*Impedance:* 50 ohms or 200 ohms, selectable by recessed switch. *Frequency Response:* 50-14,000 cps. *Output Level:* -55 db. *Size:* 7 $\frac{1}{8}$ " long, 1 $\frac{1}{8}$ " diameter. *Color:* Gray.

Part No. 097 2211 00

\$90.00

## ELECTRO-VOICE AND ALTEC-LANSING MICROPHONES

A complete line of Electro-Voice and Altec-Lansing general purpose and specialized microphones, stands, call letter plates and accessories is sold by your Collins Broadcast Equipment Sales Engineer.

## COLLINS M-20 MICROPHONE DESK STAND



A small, non-reflecting blue-gray stand that holds the Collins M-20 Microphone. The M-20 is held with a felt padded clamp that allows the microphone to be slipped in and out of the stand easily.

Part No. 097 5826 00

\$3.50

## ELECTRO-VOICE 419 MICROPHONE DESK STANDS

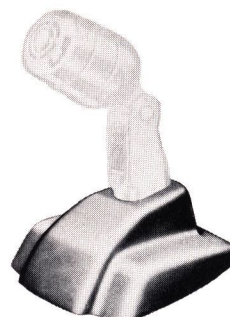

Model 419 is used with microphones using large-type stud such as EV Model 665. Model 418 desk stand is similar but for use with microphone using small-type stud. Both have die cast base and gray finish.

Part No. 097 3835 00

(Type 419)

\$6.00

Part No. 097 3132 00

(Type 418)

\$6.00

## ELECTRO-VOICE 420 MICROPHONE DESK STAND

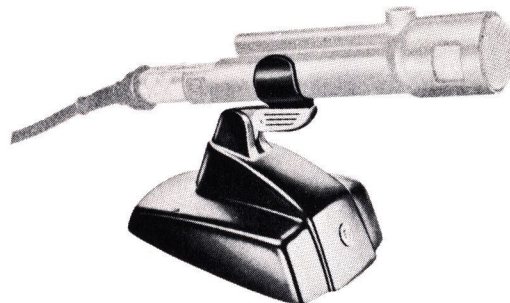

For use with microphones one inch in diameter. Clamp attachment mounts one inch cylindrical microphones without tools. Heavy cast iron, gray finish. *Weight:* 3 lbs.

Part No. 097 2438 00

\$12.00

## ATLAS DS-7 MICROPHONE DESK STAND

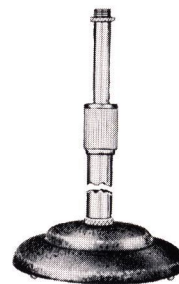

A general purpose, chrome plated adjustable desk stand with base of cast iron and finished in gun metal shrivel finish. Stable base is equipped with pads to prevent damage to desk. Equipped with standard "velvet action" clutch adjustment. Thread size at microphone end is  $\frac{5}{8}$ "-27. Adjustable from 8" to 12". *Weight:* 3 lbs.

Part No. 097 1119 00

\$3.00



# MICROPHONES

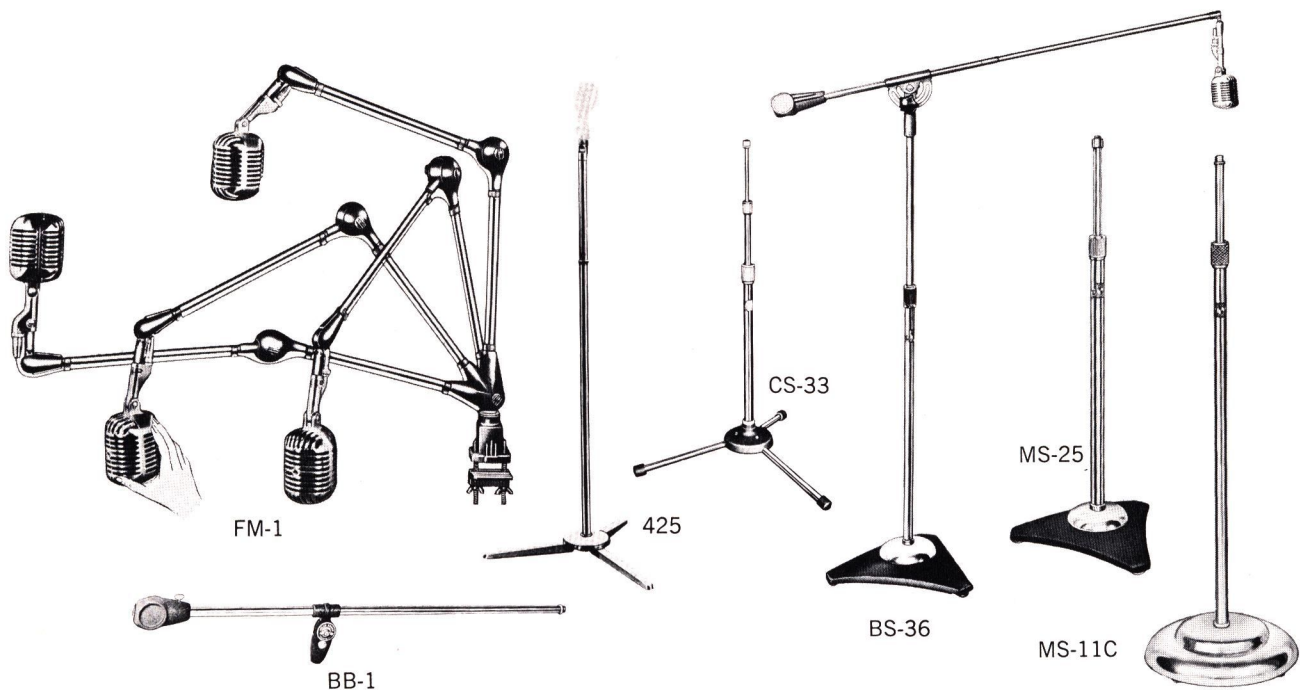

## FLEXO MIKESTER FM-1

This arm will handle any mike up to 4 lbs. It can be instantly positioned, incorporates a patented enclosed spring-controlled swiveling device, swings out 36" in any direction when fully extended. Clamps or screws to any position. Clips hold cable in place. *Weight:* 4<sup>3</sup>/<sub>4</sub> lbs.

Part No. 097 1499 00 \$8.60

## ELECTRO-VOICE 425 FLOOR STAND

One hand height control from 37" to 66". Push-button operated. Locks on release. Die-cast base with satin chrome finish. *Weight:* 7<sup>1</sup>/<sub>2</sub> lbs.

Part No. 097 1636 00 \$18.00

## ATLAS CS-33 MICROPHONE FLOOR STAND

Fully collapsible unit with "come apart" base design. The stand has a spring lock leg-holding mechanism so it may be easily disassembled for carrying. No tools or screw fastenings are required to hold the base assembly together. Chrome plated legs tipped with skid-proof rubber shock absorbent bumpers eliminate vibrational conductivity. Model CS-33 adjusts from 26" to 64" and weighs 4 lbs.

Part No. 097 1267 00 \$8.10

## ATLAS BS-36 MICROPHONE BOOM STAND

Features "safety air-lock cushion" built into the vertical section to prevent slippage of the upright. Deluxe model BS-36W with ball bearing swivel castors

available. *Boom Length:* 62". *Vertical Length:* 48" to 72". *Base Diameter:* 17". *Weight:* 33 lbs. *Finish:* Chrome and gun metal.

Part No. 097 1500 00 (Type BS-36) \$37.80  
Part No. 097 1790 00 (Type BS-36W) \$43.80

## ATLAS BB-1 MICROPHONE BOOM

This 31" microphone boom may be attached to any type of floor stand. All swivel parts are precision die castings resulting in smooth operation and secure positioning. Boom is chrome plated and has 5/8"-27 thread. *Weight:* 3<sup>1</sup>/<sub>2</sub> lbs.

Part No. 097 0984 00 \$4.50

## ATLAS MS-25 FLOOR STAND

Features "safety air-lock cushion" to prevent slippage of telescoping section. Uses a large diameter, oversize telescoping tube (7/8" telescoping tube, 1 1/8" base tube). Terminated in 5/8"-27 thread. *Finish:* Chrome and gray wrinkle. *Height Adjust:* 37" to 66". *Base Diameter:* 17". *Weight:* 24 lbs.

Part No. 097 1510 00 \$15.60

## ATLAS MS-11C FLOOR STAND

Features an extended length clutch body, inner lined with a wear-proof locking collet which grips without jamming, slipping or sudden dropping. Includes self-leveling, shock absorbing base pads, plus three additional "anti-tip" points located between the base pads. Terminates in a 5/8"-27 thread. *Finish:* Chrome or gray wrinkle (Model MS-10C). *Height Adjust:* 35" to 65". *Base Diameter:* 10". *Weight:* 12 lbs.

Part No. 097 1511 00 (Type MS-11C) \$7.80  
Part No. 097 5729 00 (Type MS-10C) \$8.58



# STUDIO ACCESSORIES

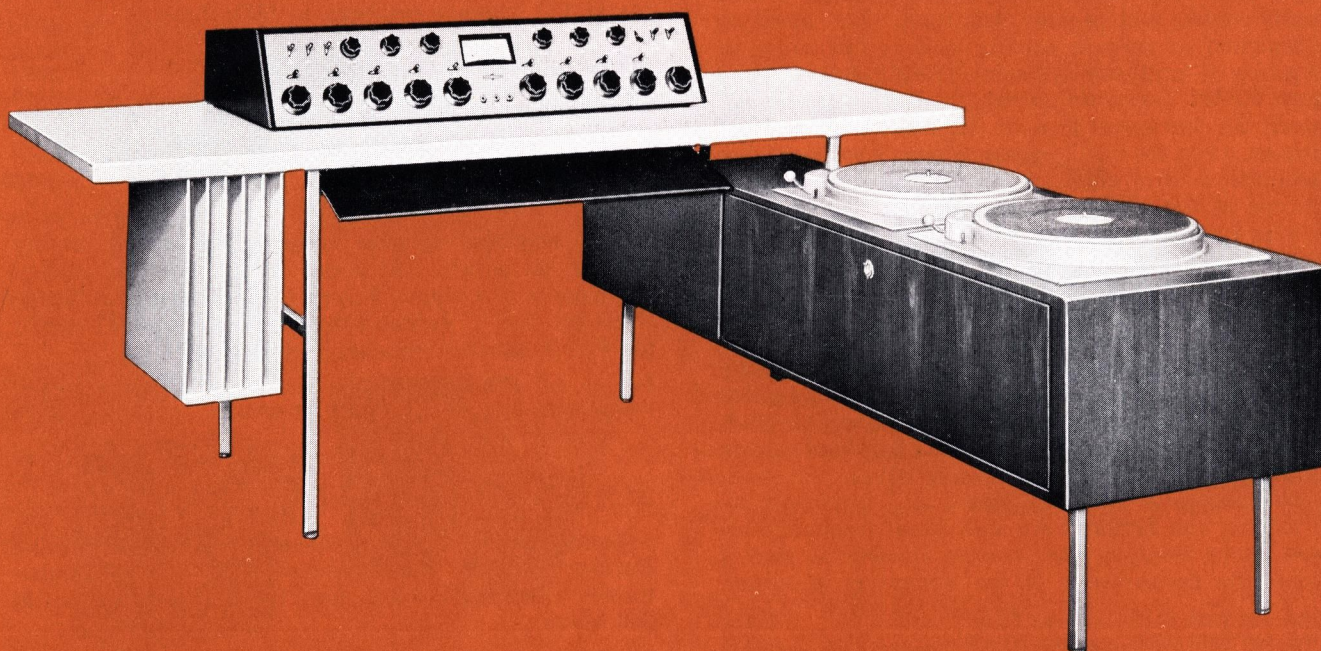

## COLLINS CUSTOM CONTROL DESKS

Attractiveness is combined with operational efficiency and economy in Collins control desks, custom designed to each broadcaster's requirements. These desks are sturdily constructed of wood covered with any of a wide range of patterns of long lasting Formica.

Among the features that may be incorporated without sacrificing attractiveness are adjustable feet, built-in record compartments, hidden console cables

and provisions for rack mounting.

A Collins automatic programming desk wing console may be placed on left wing to give complete studio facilities in one compact unit. Collins will provide free estimates upon submission of the physical layout of the studio and an outline of functions desired for inclusion in the desk.

No Part Number

Price on Request

77



**COLLINS CS-8/12 LOUDSPEAKERS**

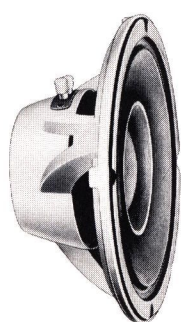

CS-8

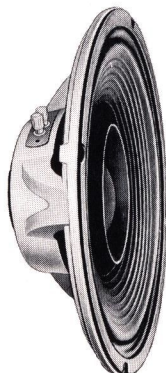

CS-12

Producing the very finest in high fidelity sound, the Collins CS-8 and CS-12 loudspeakers produce a consistently stable and precise definition. The speakers are designed to operate equally well at full range or as woofers in multiway systems. The CS-8 and CS-12 feature Radax construction, which divides the sound between the two cones in each speaker. A mechanical crossover, when the smaller cone responds to the higher frequencies, occurs at 2,000 cps in the CS-8 and at 1,800 cps in the CS-12.

A slug-type magnet is used for concentrating flux density into the air gap. This type magnet has the lowest possible leakage and greatest structural strength. The high frequency long throw voice coil remains in the air gap even on the longest of excursions to prevent non-linear operation.

An edge-wound voice coil, which gains an equivalent of five extra watts from most amplifiers over round-wire coils, is wound with precision, flattened ribbon conductor.

Each speaker is carefully tested and inspected before leaving the factory. An individual frequency response curve check is run on each speaker so that it matches the performance of the laboratory standard.

Part No. 097 6038 00	(Type CS-8)	\$13.50
Part No. 097 6039 00	(Type CS-12)	\$14.75
Part No. 097 1706 00		\$4.95

Jensen ZY-2002 Transformer for Collins CS-8/12 Speakers.

**JENSEN H-222 SPEAKER**



A coaxial, 12" speaker, the H-222 has electrically and acoustically independent "woofer" and "tweeter," and employs the through-bore compression driver tweeter. *Frequency Range:* 30-15,000 cps. *Impedance:* 16 ohms. *Power Rating:* 25 watts. *Baffle Opening:* 10½". *Weight:* 12 lbs. Jensen transformer (ZY-2003) for H-222 speaker matches to 600 ohms.

Part No. 097 1713 00	(Type H-222)	\$62.50
Part No. 097 1724 00	(Type ZY-2003)	\$5.95
Part No. 097 4919 00	(Type ST-946)	\$3.50

Jensen balance control.

**JENSEN P12-T SPEAKER**

This economy speaker is ideal for a high fidelity system to which additional units may be added. *Impedance:* 3.2 ohms. *Power Rating:* 12 watts. *Baffle Opening:* 10½". Jensen transformer (Model ZY-4002) for P12-T speaker matches to 600 ohms.

Part No. 097 2119 00	(Type P12-T)	\$7.08
Part No. 097 2121 00	(Type ZY-4002)	\$3.69

**JENSEN P8-T SPEAKER**

Similar to the P12-T. *Impedance:* 3.2 ohms. *Power Rating:* 12 watts. *Baffle Opening:* 6¾". Jensen transformer (Model ZY-4002) for P8-T speaker matches to 600 ohms.

Part No. 271 0016 00	(Type P8-T)	\$5.34
Part No. 097 2121 00	(Type ZY-4002)	\$3.69

	CS-8	CS-12
<i>Frequency Response:</i>	50-13,000 cps	30-13,000 cps
<i>EIA Sensitivity Rating:</i>	42 db	43 db
<i>Free-Space Cone Resonance:</i>	55 cps	40 cps
<i>Power Handling Capacity:</i>		
<i>Program Material:</i>	20 watt	20 watt
<i>Peak:</i>	40 watt	40 watt
<i>Critical Damping Factor:</i>	15	15
<i>Impedance:</i>	8 ohm	8 ohm
<i>Mechanical Crossover:</i>	2000 cps	1800 cps
<i>Voice Coil Diameter:</i>	2"	2"
<i>Total Flux:</i>	70,700 maxwells	70,700 maxwells
<i>Power Required for 100 db level:</i>	15 watt	12 watt
<i>Mounting:</i>	Four ¼" holes equally spaced on 7⅝" circle	Four ¼" holes equally spaced on 11½" circle
<i>Baffle Opening:</i>	7⅞"	11"
<i>Size:</i>	8⅜" diameter, 3½" deep	12¼" diameter, 3½" deep
<i>Weight:</i>	4½ lbs.	5½ lbs.



## JENSEN LEVEL CONTROLS

Designed for use in voice coil or line circuits of similar nominal impedance, Jensen level controls are of the two-section L-pad type. They provide continuously adjustable level without disturbance of other circuit levels or total impedance. Single hole panel mounting. Complete with lock nut, pointer knob and flat metal escutcheon plate. Model ST-760 for 4 ohms impedance, 15 watts. Model ST-411 for 8 ohms impedance, 35 watts.

Part No. 097 2190 00	(Type ST-760)	\$5.25
Part No. 097 2207 00	(Type ST-411)	\$5.25

## JENSEN ST-946 BALANCE CONTROL

The ST-946 30-watt balance control is for adjusting balance of high frequency units. *Impedance:* 16 ohms. Leads 25" long attached. Used with Jensen H-222 speaker.

Part No. 097 4919 00	\$3.50
----------------------	--------

## JENSEN ZY-2002 TRANSFORMER

Transformer for Collins CS-8/12 Speakers (8 ohms) matches to 600 ohms.

Part No. 097 1706 00	\$4.95
----------------------	--------

## ARGOS Baffles

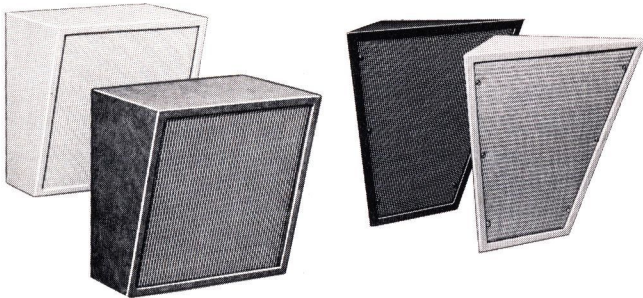

Entire front is inset with plastic grille and cloth covered panel. Constructed of plywood and hardboard for good resonant tone. Extra reinforcing blocks and four bolts installed for mounting speakers. Covering is plastic coated leatherette. Available in blonde or walnut. Slanting corner baffle for 8" speaker (SCB-8A) or 12" speaker (SCB-12A). *Weight:* 6 lbs. or 8 lbs. Wall baffle for 8" speaker (WB-8C) or 12" speaker (WB-12C). *Weight:* 2½ lbs. or 4¼ lbs.

Part No. 097 2671 00	(Type SCB-8A)	\$7.90
Walnut finish.		
Part No. 097 4184 00	(Type SCB-8A)	\$7.90
Blonde finish.		
Part No. 097 2672 00	(Type SCB-12A)	\$10.95
Walnut finish.		
Part No. 097 4185 00	(Type SCB-12A)	\$10.95
Blonde finish.		
Part No. 097 6006 00	(Type WB-8C)	\$4.05
Walnut finish.		
Part No. 097 6008 00	(Type WB-8C)	\$4.05
Blonde finish.		
Part No. 097 6007 00	(Type WB-12C)	\$5.55
Walnut finish.		
Part No. 097 6009 00	(Type WB-12C)	\$5.55
Blonde finish.		

## BRUSH BA-206 HEADPHONES



The Brush BA-206 headphones have an exceptionally flat response out to 10,000 cps and create outstanding fidelity of reception. Their high impedance and negligible power requirements allow monitoring without any effects on associated equipment. The special "Metalseal" crystal elements provide maximum protection against excessive humidity.

Part No. 099 0495 00	\$30.90
----------------------	---------

## BRUSH BA-200 HEADPHONES



Ideal for general purpose service, the Brush BA-200 headphones have a frequency range from 100 to 5,000 cps. They are especially suitable for general laboratory and studio work as well as for the skilled amateur. *Impedance:* 45,000 ohms at 1,000 cps. *Weight:* 6 oz.

Part No. 273 0002 00	\$16.05
----------------------	---------

## TRIMM HEADPHONES

Lightweight, rugged headphones with black Bakelite shell and cap. Rubber covered headband. *Impedance:* 600 ohms (Model 156) or 17,000 ohms (Model 157). *Weight:* 5 oz.

Part No. 273 0003 00	(Type 156)	\$9.00
Part No. 273 0004 00	(Type 157)	\$9.00

## TELECHRON 1H1612 STUDIO CLOCK

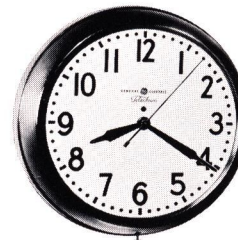

The Telechron "Commerce" clock has a 12" dial, rich brown case.

Part No. 097 1735 00	\$13.95
----------------------	---------



## STUDIO ACCESSORIES

### KAAR CONALERT



Designed expressly for CONELRAD Radio Alert. Built for 24-hour service, it gives automatic alarm with visual and aural warning. At time of radio alert, the speaker is automatically connected, you hear CONELRAD message and red pilot lamp on panel is lighted. Provision is also made for external alarm. Available in either cabinet or rack mounting models.

Part No. 097 2831 00 \$140.00  
Rack mounted.

### MIRATEL AIR ALERT



Designed to control visible and/or audible alarm circuits on CONELRAD signal from local or sky wave stations. Frequency tunable from 550 to 1600 kc. Built-in speaker operates upon alarm. Relay circuit is voltage regulated. External bell or light control terminals and antenna terminals on rear terminal board. Available for rack or table mounting.

Part No. 097 3192 00 \$99.50  
Rack mounted.

### PATCH CORDS

The plugs are of the shielded type, with the sleeves tied together and grounded. The circuit is maintained through connections to the plug tips. The following lengths are available: 6"; 12"; 24"; 36"; 48"; 60"; and 120". Other patch plugs, phone jacks and single circuit jacks available.

Part No. 361 0010 00	(6")	\$7.85
Part No. 361 0011 00	(12")	\$7.95
Part No. 361 0012 00	(24")	\$8.25
Part No. 361 0013 00	(36")	\$8.50
Part No. 361 0014 00	(48")	\$8.75
Part No. 361 0015 00	(60")	\$9.00
Part No. 361 0016 00	(120")	\$10.25

### TRIMM JACK PANELS



These panels are available in 12 pair, single row and 24 pair, double row models to fit any standard 19" rack and include such features as: solid 5/8" thick Bakelite panel with steel reinforcing; heavy gauge, special spring temper nickel/silver alloy leaves; ground lugs aligned to allow single ground bus to be run full length of strip; large palladium silver contacts; connection lugs fanned out for ease of soldering.

Part No. 097 3561 00 \$27.00  
12-pair, single row.  
Part No. 097 4200 00 \$50.00  
24-pair, double row.

### TRIMM 427-6 TERMINAL BOARD

Contains two groups of terminals, each 13 terminals long and 6 terminals high.

Part No. 097 6282 00 \$9.50

### SHIELDED WIRE AND MICROPHONE CABLE

8758 — Belden 2-conductor #20, twisted, shielded pair, stranded copper conductors, vinyl insulated.

8738 — Belden 2-conductor #22, twisted, shielded pair, solid copper conductors, vinyl insulated.

425-0023-00 — Shielded pair, #20 stranded, glass insulated.

439-5900-00 — Two-conductor #22 stranded, 7 No. 30 conductors, one red and one black conductor with one #22 groundwire. Shield is single right-hand wrap, #30 AWG maximum diameter of stranding. Nylon jacket, maximum outside diameter is .140".

8422 — Belden, shielded microphone cable, 2-conductor #22.

8412 — Belden, shielded microphone cable, 2-conductor #20.

423-0219-00 — High voltage wire, 15 kv breakdown insulation.

425-0061-00 — Shielded pair, #16 stranded cotton insulated, 15 amps.

425-0151-00 — Shielded pair, #12 stranded cotton insulated, 20 amps.

Part No. 097 6030 00	(Type 8758)	\$ .04 per ft.
Part No. 097 6029 00	(Type 8738)	\$ .03 per ft.
Part No. 425 0023 00	(Type 425 0023 00)	\$ .06 per ft.
Part No. 439 5900 00	(Type 439 5900 00)	\$ .07 per ft.
Part No. 097 1142 00	(Type 8422)	\$ .07 per ft.
In lengths of less than 100 ft. More than 100 ft., see below.		
Part No. 097 1142 00	(Type 8422)	\$ .06 per ft.
In lengths of 100 ft. or more. Less than 100 ft., see above.		
Part No. 425 0250 00	(Type 8412)	\$ .09½ per ft.
In lengths of less than 100 ft. More than 100 ft., see below.		
Part No. 425 0250 00	(Type 8412)	\$ .08½ per ft.
In lengths of 100 ft. or more. Less than 100 ft., see above.		
Part No. 423 0219 00	(Type 423 0219 00)	\$ .23 per ft.
Part No. 425 0061 00	(Type 425 0061 00)	\$ .08 per ft.
Part No. 425 0151 00	(Type 425 0151 00)	\$ .10 per ft.



## CANNON CONNECTORS

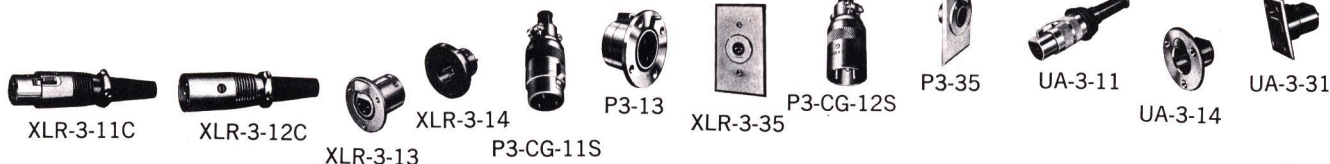

Collins Radio Company is an authorized distributor of the full line of Cannon Connectors. The following is a listing of those connectors most often required in audio applications. All are three-contact plugs unless otherwise indicated.

- P3-CG-11S — Cannon female cable plug.
- P3-CG-12S — Cannon male cable plug.
- P3-13 — Cannon female panel receptacle.
- P3-14 — Cannon male panel receptacle.
- P3-35 — Cannon single gang female wall receptacle.
- P3-35-2G — Cannon 2 gang female wall receptacle.
- XLR-3-11C — Cannon female cable plug.
- XLR-3-11SC — Cannon female cable plug with latch-lock cable clamp.
- XLR-3-12C — Cannon male cable plug.
- XLR-3-12SC — Cannon male cable plug with latch-lock cable clamp.
- XLR-3-13 — Cannon female panel receptacle, flush mount.
- XLR-3-13N — Cannon female panel receptacle with lock nut.
- XLR-3-14 — Cannon male panel receptacle, flush mount.
- XLR-3-14N — Cannon male panel receptacle with lock nut.
- XLR-3-35 — Cannon single gang female wall receptacle.
- XLR-3-35-2G — Cannon 2-gang female wall receptacle.
- XLR-3-36 — Cannon single gang male wall receptacle.
- XLR-3-36-2G — Cannon 2-gang male wall receptacle.
- UA-3-11 — Cannon female cable plug.
- UA-3-12 — Cannon male cable plug.
- UA-3-13 — Cannon female panel receptacle, flush mount.
- UA-3-14 — Cannon male panel receptacle, flush mount.
- UA-3-31 — Cannon female wall mount receptacle.
- UA-3-32 — Cannon male wall mount receptacle.

Part No. 370 2180 00	(Type P3-CG-11S)	\$4.16
Part No. 370 2190 00	(Type P3-CG-12S)	\$3.40
Part No. 370 2060 00	(Type P3-13)	\$3.68
Part No. 370 2090 00	(Type P3-14)	\$2.19
Part No. 370 2150 00	(Type P3-35)	\$5.79
Part No. 370 2170 00	(Type P3-35-2G)	\$12.50
Part No. 097 5372 00	(Type XLR-3-11C)	\$1.03
Part No. 097 5371 00	(Type XLR-3-11SC)	\$2.24
Part No. 097 5370 00	(Type XLR-3-12C)	\$.99
Part No. 097 5369 00	(Type XLR-3-12SC)	\$2.21

Part No. 097 5368 00	(Type XLR-3-13)	\$1.03
Part No. 097 5367 00	(Type XLR-3-13N)	\$1.03
Part No. 097 5366 00	(Type XLR-3-14)	\$.79
Part No. 097 5365 00	(Type XLR-3-14N)	\$.96
Part No. 097 5364 00	(Type XLR-3-35)	\$2.90
Part No. 097 5363 00	(Type XLR-3-35-2G)	\$6.30
Part No. 097 5362 00	(Type XLR-3-36)	\$2.84
Part No. 097 5361 00	(Type XLR-3-36-2G)	\$6.20
Part No. 370 2082 00	(Type UA-3-11)	\$3.89
Part No. 370 2081 00	(Type UA-3-12)	\$3.20
Part No. 370 2079 00	(Type UA-3-13)	\$2.97
Part No. 370 2083 00	(Type UA-3-14)	\$1.82
Part No. 099 0463 00	(Type UA-3-31)	\$2.97
Part No. 099 0464 00	(Type UA-3-32)	\$1.82

## BUD CR-1773-A RACK CABINET

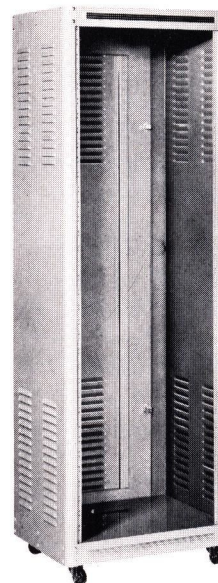

A heavy duty rack cabinet that is custom-made for Collins Radio Company. Finished in blue-gray, this cabinet is made of sturdy steel with a door on the back and provision at the top for mounting a blower fan. Provides 70" of panel space. Shipped knocked down. Size: 19" W, 76" H, 17 1/8" D.

Part No. 097 6100 00 \$75.00

## RACK CABINET BLANK PANELS

These blank panels of 3/16" aluminum are finished in blue-gray to match the BUD CR-1773-A Rack Cabinet. Size: 19" W, 1 3/4"; 3 1/2"; 5 1/4"; 7"; 8 3/4"; 10 1/2"; 12 1/4"; and 14" H.

Part No. 502 8389 113	(1 3/4")	\$2.90
Part No. 502 8393 103	(3 1/2")	\$3.75
Part No. 502 8397 113	(5 1/4")	\$4.50
Part No. 502 8401 103	(7")	\$5.00
Part No. 502 8405 103	(8 3/4")	\$5.75
Part No. 502 8409 113	(10 1/2")	\$6.75
Part No. 502 8413 103	(12 1/4")	\$7.40
Part No. 502 8417 103	(14")	\$8.25



# INDEX

## BY DESCRIPTION

Accessories, Transmission Line . . .	32-45	Cabinets, Turntable . . . . .	66	Custom Control Desk . . . . .	77
Actuator, Rotary . . . . .	16	Cable Assembly, Remote Control . . .	16	Damages in Shipment . . . . .	5
AG Potential Unit . . . . .	17	Cable, Coaxial . . . . .	32-45, 72	DC Current Unit . . . . .	17
Air Alert . . . . .	80	Cable, Studio . . . . .	80	Dehydrator . . . . .	41, 45
AM Modulation Monitor . . . . .	47	Call Letter Plates . . . . .	75	Deicer, FM Antenna . . . . .	29
AM Towers . . . . .	30, 31	Cannon Connectors . . . . .	81	Delivery . . . . .	5
AM Transmitters . . . . .	8-14	Cartridges, Automatic Programming . . . . .	61	Desk, Custom Control . . . . .	77
AM Transmitter, Remote Control . .	15-17	Cartridges, Blank Tape . . . . .	61	Desk Stands, Microphone . . .	73, 75-76
Amplifier, 250-watt . . . . .	20, 23	Cartridges, Playback Arm . . . . .	67	Desk Wing Console . . . . .	59
Amplifier, 5,000-watt . . . . .	23	Cartridge Repair Kit . . . . .	61	Detector, Linear . . . . .	48
Amplifier, Cue . . . . .	54	Cartridge Tape Racks . . . . .	60	Distortion & Noise Meter . . . . .	48
Amplifier, Limiting . . . . .	53, 56, 57	Cell, Beacon Light Control . . . . .	31	Down Payment . . . . .	4
Amplifier, Program/Monitor . . . . .	53	Choke, Tower Lighting . . . . .	14	Dual Frequency Kit, Remote . . . . .	71
Amplifier Recording & Monitoring . .	48	Clip, M-20 Microphone . . . . .	73	Dual Momentary Relay . . . . .	17
Amplifiers, Remote . . . . .	69-70	Clock, Studio . . . . .	79	Dummy Loads . . . . .	14
Amplifier, Tape Recording 58-59, 62-65		Coaxial Stacking Harness . . . . .	72	Emergency Service . . . . .	5
Antenna Current Transformer . .	15, 16	Coil, Isolation . . . . .	27	Equalizers, Phono Pre-amp . . . . .	66
Antenna Coupling Units . . . . .	14	Conalnet Receiver . . . . .	80	Eraser, Tape . . . . .	62
Antenna, FM . . . . .	28-29	Conelrad Frequency Change . . .	10, 13	Exciter, FM . . . . .	20, 23, 24
Antenna Metering Kit, Remote . . .	14	Connectors, Audio . . . . .	81	Feed-Thru Bowl . . . . .	45
Antennas, Remote . . . . .	72	Connectors FM Antenna . . . . .	30, 72	Field Intensity Meter . . . . .	48
Antenna Stacking Harness . . . . .	72	Connectors, Remote Amplifier . . .	70	Field Service . . . . .	5
Antenna Tuning Units . . . . .	14	Connectors, Transmission Line . . . . .	32-45, 72	Fittings, Nitrogen Tank . . . . .	42
Antenna, Yagi . . . . .	72	Console, Bracket Assembly . . . . .	55	Floor Stands, Microphone . . . . .	75-76
Arms, Playback . . . . .	66-67	Console, Desk Wing . . . . .	59	FM Antennas . . . . .	28-29
Audio Oscillators . . . . .	47, 48	Console Jumper Plug . . . . .	55	FM Exciter . . . . .	20, 23, 24
Audio Wire . . . . .	80	Console, Production Cabinet . . . . .	59	FM Monitor . . . . .	46
Auto-Level Limiting Amplifier . . . .	56	Consoles, Speech Input . . . . .	49-52, 68	FM Stereo Multiplex Generator . . .	24
Automatic Programming Equipment . . . . .	58-61	Console Test Cable . . . . .	55	FM Towers . . . . .	30, 31
Azimuth Head Alignment Tape . . . .	61	Console-Turntable, Remote . . . . .	68-69	FM Transmitters . . . . .	18-23
Baffles, Speaker . . . . .	79	Contactors, RF . . . . .	27	Frequency Deviation Monitor . . . . .	47
Balance Control . . . . .	78, 79	Control, Balance . . . . .	79	Gain Reduction Kit, 212F-2 . . . . .	52
Batteries, Remote Amplifier . . .	69, 70	Control, Beacon Light . . . . .	31	Ground Screen . . . . .	31
Beacon Light Control . . . . .	31	Control Panels, Remote . . . . .	60	Ground Strap . . . . .	31
Blank Rack Panels . . . . .	81	Control Unit, Remote . . . . .	72	Ground Wire . . . . .	31
Booms, Microphone . . . . .	76	Conversion Kits, Tape Recorder . . .	65	Guarantee . . . . .	5
Bowl, Feed-Thru . . . . .	45	Conversion Kits, Transmitter . . . . .	14	Head Alignment Tape . . . . .	61
Bracket Assembly, Console . . . . .	55	Cords, Patch . . . . .	80	Headphones . . . . .	79
Bumper Mount, Antenna . . . . .	72	Coupling, Antenna . . . . .	14, 72	Heating Element, FM Antenna . . . .	29
Cabinet, Rack & Panels . . . . .	81	Crystals, Transmitter . . . . .	10, 13, 20, 23, 71	Housing, Isolation Coil . . . . .	27
Cabinets, Speaker . . . . .	59, 79	Cue Amplifier . . . . .	54		
Cabinets, Tape . . . . .	60	Cue Speaker Kit, 212F-2 . . . . .	52		



Isolation Coil	27	Power Supply, Remote	71-72	Strap, Ground	31
Isolators, Feed-Thru Bowl	45	Preamplifiers, Phono Equalizer	66	Studio Cable	80
Jack Panels	80	Preamplifier, Speech Input		Studio Clock	79
Jumper Plug, Console	55	Console	53	Styli	67
Latching Relay	17	Prices	4	Substitution of Equipment	4
Lavalier Microphone Clip	73	Production Console Cabinet	59	Tape, Bulk	61
Level Controls	79	Program/Monitor Amplifier	53	Tape Cartridges	61
Light Control, Beacon	31	Pump, Transmission Line	41	Tape Cartridge Racks	60
Limiting Amplifier	53, 56, 57	Racks, Tape Cartridge	60	Tape Cartridge Repair Kit	61
Line, Transmission	32-45	Rack Cabinet	81	Tape Eraser	62
Linear Detector	48	Rack Cabinet Panels	81	Tape, Head Alignment	61
Loads, Dummy	14	Rack Mounting Shelf	55	Tape, Lubricated	61
Loops, Phase Sampling	27	Receiver, Conelrad	80	Tape Playback	58-59
Loudspeakers	78-79	Receiver, Remote	71	Tape Recorders	58-59, 62-65
Marti Remote Equipment	71-72	Receptacles, Connector	81	Tape Recorder Conversion Kits	65
Meters, Distortion & Noise	48	Recorder, Automatic		Tape, Recording	61
Meter, Field Intensity	48	Programming	58-59	Tape Splicer, Cutter	62
Meter Panel	16	Recorders, Portable	62-64	Taxes on Equipment	4
Meter, Remote	16	Recorders, Tape	58-59, 62-65	Terminal Board	80
Meter, Sampling Unit	17	Recording Tape	61	Terms of Sale	4
Microphones	73-75	Rectifiers, FM Transmitter	20, 23	Test Cable, Console	55
Microphone Booms	76	Regional Sales Offices	3	Test Equipment	47-48
Microphone Cable	80	Relay, Dual Momentary	17	Towers, AM & FM	30, 31
Microphone Call Letter Plates	75	Relay, Latching	17	Tower Lighting Chokes	14
Microphone Clip, M-20	73	Relay Unit, Console	55	Tower Lighting Remote Control	16
Microphone Stands	73, 75-76	Remote Antenna Metering Kit	14	Transformer Antenna Current	15, 16
Modification of Equipment	4	Remote Control, Recorders	60, 64, 65	Transformers, Loudspeaker	78, 79
Modulation Monitor	47	Remote Control,		Transformers, Ring	31
Monitor, Frequency Deviation	47	Transmitters	15-17, 72	Transformers, Tape Recorder	65
Monitor, FM	46	Remote Meter Kits	14	Transformer, Turntable	65
Monitor, Modulation	47	Remote Microphone-Amplifier	74	Transistors,	
Monitor, Phase	47	Remote Transmitter	71	FM Transmitter	20, 23, 24
Monitor/Program Amplifier	53	Remote Transmitting Accessories	72	Transmission Line	32-45, 72
Multiplex, FM Stereo	24	Remote Turntable-Console	68-69	Transmission Line	
Nitrogen Tank Fittings	42	Returned Goods	5	Accessories	32-45, 72
Ordering Information	4	RF Contactors	27	Transmission Line Dehydrators	41, 45
Oscillators, Audio	47, 48	Rheostat, Motorized Plate	17	Transmission Line Pump	41, 45
Pad, Turntable Indentation	65	Ring Antenna	28-29	Transmitters, AM	8-14
Panels, Blank	81	Ring Transformers	31	Transmitters, AM Conversion Kits	14
Panels, Jack	80	Rotary Actuator	16	Transmitters, FM	18-23
Panels, Remote Control	60	Sales Offices, Regional	3	Transmitter, Remote	71
Patch Cords	80	Sampling Loops, Phase	27	Tubes, Console Modules	53-54
Phase Monitor	47	Sampling Unit, Meter	17	Tubes, Limiting Amplifier	54, 56, 57
Phase Sampling Loops	27	Screen, Ground	31	Tubes, Monitor	47
Phasor	25-26	Service, Emergency	5	Tubes, Speech Input Console	50-52
Phono Equalizer Pre-amp	66	Shelf Assembly, Console	55	Tubes, Transmitter	10, 13, 20, 23
Plate Rheostat	17	Shielded Wire	80	Tuning Units, Antenna	14
Plates, Microphone	75	Shipment of Equipment	5	Turntables	65
Playback Arms	66-67	Short Wave Conversion	10, 13	Turntable Arms	66-67
Playback Arm Cartridges	67	Signed Orders	4	Turntable Cabinet	66
Playback, Automatic		Speakers	79	Turntable-Console, Remote	68-69
Programming	58-59	Speaker Cabinets	59, 79	Turntable Indentation Pad	65
Playback Tape Cartridges	61	Speech Input Consoles	49-52, 68	Turntable Transformer	65
Power Reduction Kits	10, 13	Splicer, Tape	62	Vehicle Antenna	72
Power Supplies, Console	54	Stacking Harness, Antenna	72	Wire, Ground	31
		Stands, Microphone	73, 75-76	Wire, Shielded	80
		Station Layouts	6-7	Yagi Antenna	72
		Stereo Multiplex Generator, FM	24		
		Stereo Playback Arms	67		
		Stereo Tape Recorders	62-65		



# INDEX

## BY TYPE NUMBER

1H1612 Clock	79	100-825 Transmission Line	43	252/U-260/U Transmission Line	44
2YC Stacking Harness	72	100-835 Transmission Line	44	274K Relay Units	55
4G Cartridge and Styli	67	108 Phase Monitor	47	300 Cartridge	61
11RS-2Q Receiver	71	108-0C Remote Control	15	300-815 Flange	42
20-150 Wrap Lock	45	108-0D Remote Control	15	300-825 Flange	43
20V-3 AM Transmitter	8	108-0F Remote Control	16	300-835 Flange	44
20V-3 Antenna Current Transformer	15	108-1C Remote Control	15	300J-2 Conversion Kit	14
20V-3 Remote Antenna		108-1D Remote Control	15	302-815 Insulator	42
Metering Kit	14	108-1F Remote Control	16	302-825 Insulator	43
20V-3 Tower Lighting		108-3A Antenna Current	16	305-835 Connector	44
Filter Choke	14	108-4A-1 Latching Relay	17	308-815 Ring	42
21E Conversion Kit	14	108-5A-1 Tower Lighting	16	308-825 Ring	43
21E/M AM Transmitter	11	108-6A-AC Potential	17	308-835 Ring	44
21E/M Antenna Current		108-8C/D Meter Sampling	17	310-825 Connector	43
Transformer	15	108-9A/B/C/D-1 DC Current	17	310-835 Connector	44
21E/M Remote Antenna		108-10A Rotary Actuator	16	313T Remote Control Panels	60
Metering Kit	14	108-13B Meter Panel	16	335BR FM Monitor	46
21E/M Tower Lighting		108-18 Dual Momentary Relay	17	340 Tower	30
Filter Choke	14	108-21B Motorized Plate Rheostat	17	351 Recorders	63
22R Flange	32	108-34 Cable Assembly	16	356A-1 Preamplifier	53
26J-1 Limiting Amplifier	56	111A Recording Tapes	61	356B-1 Program/Monitor	
26U-1 Limiting Amplifier	57	120-E Intensity Meter	48	Amplifier	53
30-150 Dehydrator	45	121 Accessory Unit	48	356E-1 Limiting Amplifier	53
37M FM Antenna	28	124-1625 Adapters	45	356H-1 Phono Equalizer Pre-amp	66
42E Antenna Coupling	14	135-15 Insulators	45	356Q-1 Cue Amplifier	54
49U-1 Housing	27	144A-1 Isolation Coil	27	404 Linear Detector	48
75N Jack	33	145-101-13 RF Contactor	27	409X-2 Power Supply	54
75R Flange	33	150-18 Recording Tape	61	409Y-1 Power Supply	54
75T Terminal	34	156/157 Headphones	79	410 Distortion Meter	48
75U Jack	33	170KD Tower	30	418/419 Microphone Desk Stands	75
77N Jack	34	172G Dummy Load	14	420 Microphone Desk Stand	75
77R Flange	34	180 Tower	30	425 Microphone Stand	76
77S Connector	35	190-18 Recording Tape	61	427-6 Terminal Board	80
77U Jack	34	200 Oscillator	48	448-815 Assembly	42
79 Couplings	45	200C Tape Eraser	62	448-825 Assembly	43
81 Adapters	45	208-S Playback Arms	67	480 Tower	30
81M Phasor	25	212E-1 Console	49	485-835 Assembly	44
82 Adapters	45	212F-2 Console	52	494-815 Assembly	42
83A Transmission Line	35	212G-1 Console	50	494-825 Assembly	43
85 Adapters	45	212H-1 Remote Amplifier	69	494-835 Assembly	44
90 Recorder	64	212-TN Playback Arm	66	499G-1 Shelf	55
91-93 Recorders	64	212Z-1 Remote Amplifier	70	500-815 Gas Barrier	43
95 End Seals	45	216C-1 Record Amplifier	58	500-835 Gas Barrier	44
100-815 Transmission Line	42	220 Tower	30	505-815 End Seal	43



505-825 End Seal	43	2360 Adapter	37	A-2101 Ring Transformer	31
505-835 End Seal	44	2361 Adapter	39	ASP-143 Bumper Mount	72
550A-1 Conversion Kit	14	2962 Break-away Section	40	ASP-177 Antenna	72
550A-2 AM Transmitter	10	3900 Anchor	38	B801 Recorder	64
550A-2 Remote Antenna		3901 Anchor	39	BA-200/206 Headphones	79
Metering Kit	14	3902 Anchor	41	BB-1 Microphone Boom	76
560 Transmission Line	37	3911 Hanger	39	BS-36 Microphone Stand	76
561 Transmission Line	38	3912 Hanger	41	CR-1773-A Rack Cabinet	81
562A Transmission Line	39	3921 Brace	39	CS-8/12 Loudspeakers	78
564A Phase Sampling Loop	27	3922 Brace	41	CS-33 Microphone Stand	76
600 Cartridge	61	4850 Adapter	34	CWW-1 Production Console	59
601 Recorder	62	4851 Adapter	35	DF Dual Frequency Kits	71
602C Equalizer	66	4855 Adapter	36	DS-7 Microphone Desk Stand	75
620 Amplifier-Speaker	63	4861A Coupling	39	DWW-3 Desk Wing Console	59
642A-1 Playback	58	4862A Coupling	40	FM-1 Microphone Holder	76
652-678 Recorders	62	4868 Adapter	36	H2 Transmission Line	32
665/666 Microphone	75	6102 Mounting Strap	36	H3 Transmission Line	33
740 Transmission Line	36	8319A Connector	36	H5 Transmission Line	33
786M-1 Stereo Multiplex Generator	24	8329A Adapter	36	H7 Transmission Line	34
808A-1 Turntable-Console	68	8412/8422 Cables	80	H-22 Loudspeaker	78
824 Recorder	64	8738/8758 Cables	80	HD-11M Tape Eraser	62
830A-2 FM Exciter	23	10804-36 Connector	33	M-3-60 Remote Transmitters	71
830B-1 FM Transmitter	18	10805-1 Connector	33	M-20 Microphone	73
830D/F/H-1 FM Transmitter	23	11662-2 Hanger	34	M-30 Microphone	74
830E-1 FM Transmitter	21	12291A Adapter	37	M-40 Microphone	74
858 Tank Fittings	42	12394 Adapter	37	M-50 Microphone	74
878 Pump	41	12395-1 Wrap Lock	33, 34, 35	M-60 Remote Microphone	74
980GV Cable Cap	37	12423 Adapter	37	M-90 Recorder-Amplifier	63
990GV Cable Cap	36	12430 Clamp	39	M-100 Microphone	73
1060 Elbow	34, 37	12431 Clamp	40	M232/236 Playback Arms	67
1061 Elbow	35, 38	12692A Adapter	37	MA-1 Antenna	72
1062 Elbow	32, 40	13223A Flange	37	MM-151 Recording Tape	61
1070 Elbow	34	13550 Clamp	39, 41	MS-11C Microphone Stand	76
1071 Elbow	35	13552 Spacer	39, 41	MS-25 Microphone Stand	76
1072 Miter Elbow	32	13555 Adapter	38, 39, 41	P3 Connectors	81
1162 Elbow	40	13889 Hanger	38	P8/12-T Loudspeaker	78
1181-B Frequency Deviation		13924 Hanger	39	PA-1 Antenna	72
Monitor	47	13925 Hanger	40	PT6-6 Recorder-Amplifier	63
1200 Cartridge	61	13926 Hanger	40	RA-2 Antenna	72
1251 Recording Tape	61	13927 Hanger	40	RA-150 Receiver	71
1260A Gas Barrier	34, 37	14068 Insulator	41	RC8 Remote Control	64
1261B Gas Barrier	35, 39	14139 Adapter	37	RG Transmission Line	42
1262A Gas Barrier	32, 40	14327 Hanger	38	RMC-1 Remote Control	72
1271 Gas Barrier	35	14328 Hanger	38	S-260/320 Playback Arms	67
1272 Gas Barrier	32	14378 Hanger	39	S450 Transmission Line	36
1301-A Oscillator	47	14379 Hanger	39	SC-155-B Antenna	72
1362 Coupling	40	15060 Connector	35	SCB-8A/12A Baffles	79
1560A Flange Kit	37	18275 Connector	34, 38	ST-466 Splicing Tape	62
1561A Flange Kit	39	19170 Flexible Section	39	ST-760/411 Level Control	79
1701 End Terminal	36	19209B Flexible Section	40	ST-946 Balance Control	78, 79
1703 End Terminal	37	19256A Hoisting Kit	34	TCFW Turntable Cabinets	66
1860 Reducer	34, 38, 39	20695 Flexible Section	39	TI-2017/2035 Ring Transformer	31
1861 Reducer	39, 40	22417 Hanger	32	TPS-1 Power Supply	72
1861 Recording Tape	61	22418 Hanger	32	TPS-TC Mobile Assemblage	72
1862 Reducer	32	23145 Grounding Kit	32	TR-2 Playback	64
1910A Dehydrator	41	23187 Adapter	40	TS4-DLX Splicer-Cutter	62
1931-B Modulation Monitor	47	24259 Connector	35	TT-200/400 Turntables	65
1932-A Distortion Meter	48	24312 Hoisting Kit	35	UA Connectors	81
2061 End Terminal	35	24622 Hanger	35	WB-8C/12C Baffles	79
2062 End Terminal	32, 40	24810 Grounding Kit	34	WG-52 Dummy Load	14
2071 End Terminal	35	24811 Grounding Kit	35	XLR Connectors	81
2072 End Terminal	32	25385 Connector	34	XR-1 Crystal	71
2260 Adapter	37	63305-C Beacon Light Control	31	ZY-2002 Transformer	78, 79
2261 Adapter	39	700105-700108 Transformers	65	ZY-2003 Transformer	78
2262 Adapter	40	A-1971 Ring Transformer	31	ZY-4002 Transformer	78



# INDEX

## BY PART NUMBER

013 0020	37M-1	29	097 5209 00	300	61	099 0516 00	23145	32
013 0030	37M-2	29	097 5210 00	600	61	099 0517 00	30-150	45
013 0040	37M-3	29	097 5211 00	1200	61	099 0541 00	TPS-TC	72
013 0050	37M-4	29	097 5220 00	A-1971	31	099 0542 00	RMC-1	72
013 0060	37M-5	29	097 5301	83A	35	099 0543	RA-2	72
013 0070	37M-6	29	097 5309 00	1701AP	36	099 0544	SC-155-B	72
013 0080	37M-7	29	097 5350 00	DWW-3	59	099 0545	ASP-177	72
013 0090	37M-8	29	097 5361 00	XLR-3-36-2G	81	099 0546 00	83-13P	72
013 0099	Deicer	31	097 5362 00	XLR-3-36	81	099 0547 00	83-1J	72
013 0107 00	Screen	39	097 5363	XLR-3-35-2G	81	099 0548 00	GR-6355	72
015 0519 00	726	70	097 5364	XLR-3-35	81	099 0549 00	87-500	72
015 0520 00	763	70	097 5365	XLR-3-14N	81	099 0550	M-3-60B	71
097 0811 00	Strap	31	097 5366	XLR-3-14	81	099 0551	M-3-60B/TPS	71
097 0984 00	BB-1	76	097 5367	XLR-3-13N	81	099 0552	M-3-60C	71
097 1119 00	DS-7	75	097 5368	XLR-3-13	81	099 0553	M-3-60C/11RS-2Q	71
097 1142 00	8422	80	097 5369	XLR-3-12SC	81	099 0554	XT-1	71
097 1185 00	410	48	097 5370	XLR-3-12C	81	099 0555	DFT	71
097 1186 00	200	48	097 5371	XLR-3-11SC	81	099 0556	DF-RMC	71
097 1267 00	CS-33	76	097 5372	XLR-3-11C	81	099 0557	RA-150	71
097 1445 00	Strap	31	097 5405 00	1860	34	271 0016 00	P8-T	78
097 1453 00	108-4A-1	17	097 5419 00	145-201-13	27	272 1407 00	111A-12	61
097 1454 00	108-8C	17	097 5420 00	145-202-13	27	272 1408 00	111A-6	61
097 1458 00	108-10A	16	097 5436 00	77R	34	272 1438 00	602C	66
097 1461 00	108-18	17	097 5447 00	4851	35	273 0002 00	BA-200	79
097 1499 00	FM-1	76	097 5463 00	M-40	74	273 0003 00	156	79
097 1500 00	BS-36	76	097 5464 00	M-20	73	273 0004 00	157	79
097 1501 00	135-15-1	45	097 5511 00	145-101-13	27	277 0002 00	1932-A	48
097 1510 00	MS-25	76	097 5516 00	120-E	48	277 0008 00	1301-A	47
097 1511 00	MS-11C	76	097 5527 00	2361	39	361 0010 00	Cord	80
097 1528 00	PM-12	29	097 5528 00	300	61	361 0011 00	Cord	80
097 1636 00	425	76	097 5610	S450	36	361 0012 00	Cord	80
097 1646 00	108-5A-1	16	097 5620 00	1061	38	361 0013 00	Cord	80
097 1693 00	37M-10	29	097 5621 00	1062	32	361 0014 00	Cord	80
097 1698 00	63305-C	31	097 5624 00	1910A	41	361 0015 00	Cord	80
097 1706 00	ZV-2002	79	097 5646 00	135-15-7	45	361 0016 00	Cord	80
097 1713 00	H-222	78	097 5727 00	Rack	60	370 2060 00	P3-13	81
097 1724 00	ZV-2003	78	097 5729 00	MS-10C	76	370 2079 00	UA-3-13	81
097 1735 00	1H1612	79	097 5779 00	M-60	74	370 2081 00	UA-3-12	81
097 1790 00	BS-36W	76	097 5788 00	4868	36	370 2082 00	UA-3-11	81
097 1846 00	108-3A	16	097 5754 00	1262A	32	370 2083 00	UA-3-14	81
097 1937 00	108-34	16	097 5826 00	Stand	75	370 2090 00	P3-14	81
097 1976 00	108-0C	15	097 5852 00	MM-151	61	370 2150 00	P3-35	81
097 1977 00	108-1C	15	097 5914 00	600	61	370 2170 00	P3-35-2G	81
097 2004 00	108-21B	17	097 5915 00	1200	61	370 2180 00	P3-CG-11S	81
097 2016 00	108-9A-1	17	097 5947 00	1931-B	47	370 2190 00	P3-CG-12S	81
097 2017 00	108-9B-1	17	097 5948	1181-B	47	421 1010 00	Wire	31
097 2018 00	108-9C-1	17	097 5958 00	4850	34	423 0219 00	Cable	80
097 2019 00	108-9D-1	17	097 5959 00	2360	37	425 0023 00	Cable	80
097 2036 00	108-6A	17	097 5960 00	878	41	425 0061 00	Cable	80
097 2039 00	1251	61	097 5966	2761	38	425 0151 00	Cable	80
097 2049 00	108-8D	17	097 5968 00	3901	39	425 0250 00	8412	80
097 2051 00	108-0D	15	097 5969 00	13924	39	429 5900 00	Cable	80
097 2052 00	108-1D	15	097 5970 00	14379	39	452 8389 113	Panel	81
097 2058 00	TS4-DLX	62	097 5972 00	14378	39	452 8393 103	Panel	81
097 2068 00	108-21B	17	097 6006 00	WB-8C	79	452 8397 113	Panel	81
097 2069 00	108-21V	17	097 6007 00	WB-12C	79	452 8401 103	Panel	81
097 2119 00	P12-T	78	097 6008	WB-8C	79	452 8405 103	Panel	81
097 2121 00	ZY-4002	78	097 6009 00	WB-12C	79	452 8409 113	Panel	81
097 2190 00	ST-760	79	097 6029 00	8738	80	452 8413 103	Panel	81
097 2207 00	ST-411	78	097 6030 00	8758	80	452 8417 103	Panel	81
097 2208 00	404	48	097 6038 00	CS-8	78	452 8418 103	Panel	81
097 2211 00	665	75	097 6039 00	CS-12	78	452 8419 103	Panel	81
097 2438 00	420	75	097 6050 00	1861	39	452 8420 00	Panel	81
097 2671 00	SCB-8A	79	097 6076 00	Tape	61	452 8421 00	Panel	81
097 2672 00	SCB-12A	79	097 6100 00	CR-1773-A	81	452 8422 00	Panel	81
097 2831 00	Conalert	80	097 6122 00	13925	40	452 8423 00	Panel	81
097 2888 00	M-90ACX	63	097 6124 00	13555	38	452 8424 00	Panel	81
097 2889 00	M-90R	63	097 6131 00	TCFW-2	66	452 8425 00	Panel	81
097 2992 00	1861	61	097 6151 00	TR-2	64	452 8426 00	Panel	81
097 3009 00	108-0F	16	097 6219 00	15069	35	452 8427 00	Panel	81
097 3012 00	108-1F	16	097 6225 00	TCFW-4	66	452 8428 00	Panel	81
097 3035 00	108-13B	16	097 6282 00	427-6	80	452 8429 00	Panel	81
097 3036 00	666	75	097 6285 00	TT-250S	65	452 8430 00	Panel	81
097 3132 00	418	80	097 6286 00	TT-450S	65	452 8431 00	Panel	81
097 3192 00	Alert	75	097 6296 00	8319A	36	452 8432 00	Panel	81
097 3362 00	A-2101	31	097 6351 00	1561A	39	452 8433 00	Panel	81
097 3561 00	Panel	80	097 6611 00	4855	30	452 8434 00	Panel	81
097 3736 00	TT-400	65	097 6627 00	Clip	73	452 8435 00	Panel	81
097 3737 00	TT-400S	65	097 6630	11RS-2Q	71	452 8436 00	Panel	81
097 3806 00	PT6-6A	64	097 6631	100-835	44	452 8437 00	Panel	81
097 3807 00	PT6-6J	64	097 6632 00	485-835	44	452 8438 00	Panel	81
097 3811 00	TT-200S	65	097 6635 00	310-835	44	452 8439 00	Panel	81
097 3835 00	419	75	097 6647 00	M-30	74	452 8440 00	Panel	81
097 3844 00	4GS-01D	67	097 6653 00	TPS-1	72	452 8441 00	Panel	81
097 3845 00	4GS-02D	67	097 6673 00	135-15-3	45	452 8442 00	Panel	81
097 3846 00	4GS-01S	67	097 6640 00	305-835	44	452 8443 00	Panel	81
097 3847 00	4GS-02S	67	097 6739 00	494-825	43	452 8444 00	Panel	81
097 3848 00	4GD-01D-02S	67	097 6742 00	308-835	44	452 8445 00	Panel	81
097 3849 00	4GD-01D-02D	67	097 6744 00	13552	39	452 8446 00	Panel	81
097 3850	4GD-01S-02S	67	097 6745 00	13550	39	452 8447 00	Panel	81
097 3851	4G-01S	67	097 6746 00	14068	41	452 8448 00	Panel	81
097 3852	4G-02S	67	097 6768 00	13926	40	452 8449 00	Panel	81
097 3853	4G-01D	67	097 6845 00	500-835	44	452 8450 00	Panel	81
097 3854	4G-02D	67	097 6880 00	ASP-143	72	452 8451 00	Panel	81
097 3971 00	TT-200	65	097 6884 00	12692A	37	452 8452 00	Panel	81
097 4184 00	SCB-8A	79	097 6920 00	TI 2017	31	452 8453 00	Panel	81
097 4185 00	SCB-12A	79	097 6944 00	300-835	44	452 8454 00	Panel	81
097 4200 00	Panel	80	097 6950	Antenna	72	452 8455 00	Panel	81
097 4491 00	PT6-6AX	64	097 6952	PA-1	72	452 8456 00	Panel	81
097 4492 00	PT6-6JX	64	097 6953	MA-1	72	452 8457 00	Panel	81
097 4693 00	351C	63	097 6986 00	494-835	44	452 8458 00	Panel	81
097 4911	335BR	46	097 7018 00	13927	40	452 8459 00	Panel	81
097 4919 00	ST-946	79	097 7023	253/U	45	452 8460 00	Panel	81
097 4937 00	1703AP	37	097 7025 00	500-815	43	452 8461 00	Panel	81
097 4938 00	1703AR	37	097 7026 00	494-815	42	452 8462 00	Panel	81
097 4974 00	145-102-13	27	097 7042 00	2061	35	452 8463 00	Panel	81
097 5010 00	12395-1	33	097 7078	257/U	45	452 8464 00	Panel	81
097 5145 00	351U	63	097 7079 00	81-1625	45	452 8465 00	Panel	81
097 5172 00	200C	62	097 7080 00	85-1625	45	452 8466 00	Panel	81
097 5205 00	300	61	097 7081	100-825	43	452 8467 00	Panel	81
097 5206 00	300	61	097 7084 00	302-825	43	452 8468 00	Panel	81
097 5207 00	300	61	097 7085 00	500-825	43	452 8469 00	Panel	81
097 5208 00	300	61	097 7096	561	38	452 8470 00	Panel	81
097 7112 00	150-18	61	097 7112 00	150-18	61	099 0404 00	1060	34
097 7252 00	308-825	43	097 7252 00	308-825	43	099 0405 00	1070	34
097 7253 00	Transformer	65	097 7253 00	Transformer	65	099 0406 00	18275	34
097 7262 00	23187	40	097 7262 00	23187	40	099 0407 00	25385	34
097 7277 00	3921	39	097 7277 00	3921	39	099 0408 00	19256A	34
097 7283	562A	39	097 7283	562A	39	099 0409 00	24810	34
097 7511 00	448-825	43	097 7511 00	448-825	43	099 0410 00	11662-2	34
097 7522 00	CWW-1	59	097 7522 00	CWW-1	59	099 0411	H7-75	34
097 7527	254/U	45	097 7527	254/U	45	099 0412 00	77R-75	34
097 7528 00	82-875	45	097 7528 0					



