



TRANSISTORS

The Miracle of the Electronic Age



LAFAYETTE
 Leads the Field in
TRANSISTORS
 Circuits Kits & Components

Lafayette
 Radio

To Speed Shipment on Your Order Please Mention
CATALOG T4 - 56
 Remit by Check or Money Order. Include sufficient
 money for Postage. We Refund unused amounts.

- | | |
|------------------|-------------------|
| NEW YORK, N.Y. | 100 Sixth Ave. |
| BRONX, N.Y. | 542 E. Fordham Rd |
| NEWARK, N.J. | 24 Central Ave. |
| PLAINFIELD, N.J. | 139 West 2nd St. |
| BOSTON, MASS. | 110 Federal St. |



**STAY AHEAD IN
TRANSISTORS**

LAFAYETTE

DEMONSTRATION CIRCUITS

**SCHEMATIC OF TWO TRANSISTOR POCKET RADIO
WITH REGENERATIVE CIRCUIT & TRANSFORMER STAGE**

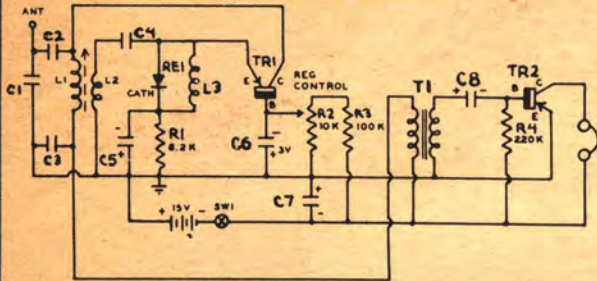

Lafayette complete kit #KT-68 complete parts, including Transistors, Transformer, Condensers, Resistors, Plastic case, Battery Holders, batteries, etc. (Less Earphones) **11.80**
For optimum results Lafayette Super Power Dynamic Earphone MS-260 is recommended **3.95**

CIRCUIT DIAGRAM OF LAFAYETTE 3 TRANSISTOR TELEPHONE PICK-UP AMPLIFIER

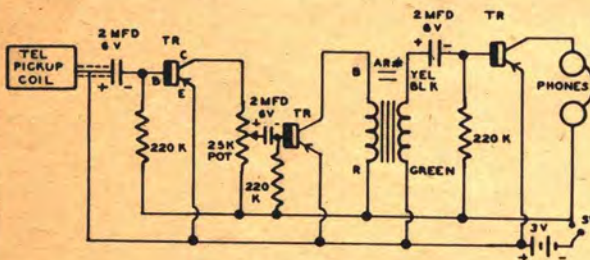

The Lafayette Transistor Telephone Pick-Up Amplifier Kit No. KT-76, includes all necessary parts, chassis, transistors, transformer, condensers, resistors, battery holder, batteries, phone tips, etc. (less Earphone and Telephone Pick-up Coil) Net **9.95**
For optimum results, Lafayette Super Power Earphone MS-260 is recommended. Net **3.95**

CIRCUIT DIAGRAM OF LAFAYETTE 3 TRANSISTOR AUDIO AMPLIFIER WITH CLASS 'B' PUSH-PULL FOR SPEAKER OPERATION

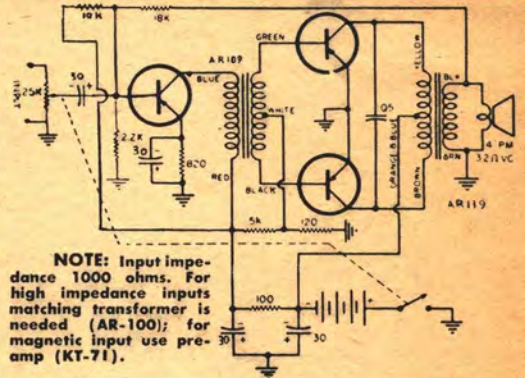

NOTE: Input impedance 1000 ohms. For high impedance inputs matching transformer is needed (AR-100); for magnetic input use pre-amp (KT-71).

Lafayette Kit — KT-69; including all parts, transistors, transformers, chassis, sockets, volume control, resistors, condensers, etc. complete with diagram and instructions. Net **17.95**

**SCHEMATIC OF
CODE PRACTICE
OSCILLATOR**

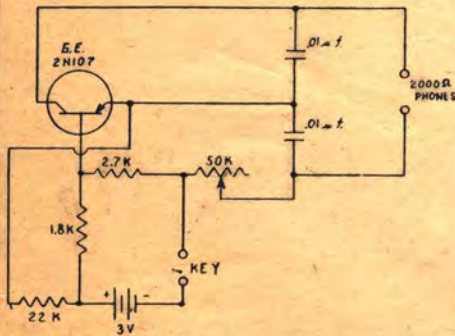

Lafayette's Kit — KT-72, including all parts, transistor, Masonite board, Telegraph Key, battery holder, batteries, condensers, resistors, Schematic and instructions (less earphones). Net **2.99**

TRANSISTOR RADIO RECEIVER

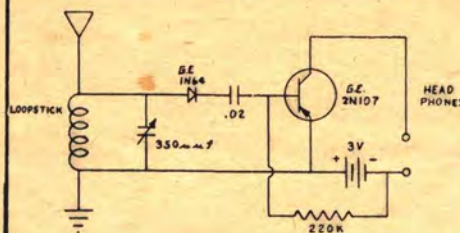

ESSENTIAL LIST OF PARTS REQUIRED

- 1 — Loopstick MS-11 **.39**
 - 1 — Variable New Miniature Condenser 365 mmf — MS-215 **.69**
 - 1 — Crystal Diode 1N64 **.50**
 - 1 — Miniature Aerovox .02 mfd Type P82 Condenser **.38**
 - 1 — 220K — 1/2 Watt Resistor **.05**
 - 1 — Raytheon CK-722 Transistor **.99**
 - 1 — Battery Holder MS-138 **.37**
 - 2 — 1 1/2 V. Penlite Cells #7 Cell .08 each **.16**
 - 1 — Transistor Socket MS-252 **.22**
- ADDITIONAL R/C COUPLED AUDIO STAGE CAN BE ADDED WITH THE FOLLOWING PARTS**
- 1 — Raytheon CK-722 Transistor **.99**
 - 1 — 15K — 1/2 Watt Resistor **.05**
 - 1 — 220K 1/2 Watt Resistor **.05**
 - 1 — .02 mfd Ceramic Condenser C-603 **.16**
 - 1 — Transistor Socket MS-252 **.22**

For optimum results: Lafayette's Super Power Dynamic Earphone MS-260 is recommended. Net **3.95**

**TWO TRANSISTOR
RADIO RECEIVER**

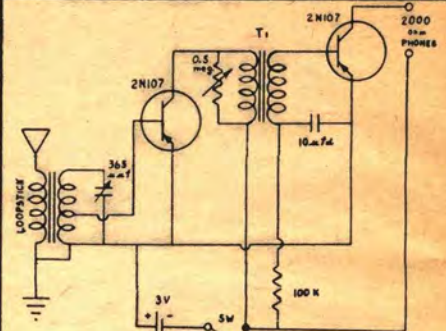

ESSENTIAL LIST OF PARTS

- 1 — Loopstick MS-11 (Note: Loopstick is to be modified — tapped between 15 and 20 turns from the free end of coil and then rewound as before and connected as indicated in diagram) **.39**
- 1 — New Miniature Variable Condenser 365 mmf — MS-215 **.69**
- 2 — G.E. — 2N107 Transistors **1.25 ea.** **2.50**
- 1 — Miniature 1/2 meg Volume Control with Switch VC-39 **.69**
- 1 — Miniature Barco 10 mfd Cond. P70-10 **.59**
- 1 — Argonne Transistor Transformer AR-100 **2.95**
- 1 — 100K 1/2 Watt Resistor **.05**
- 1 — Battery Holder for 2 #7 Cells MS-138 **.37**
- 2 — 1 1/2 Volt Penlite #7 Cell .08 each **.16**

For optimum results Lafayette's Super Power Dynamic Earphone MS-260 is recommended. Net **3.95**

Leads the Field in

TRANSISTORS & Kits Components



NEWEST PRACTICAL APPLICATIONS

THREE TRANSISTOR BROADCAST RECEIVER

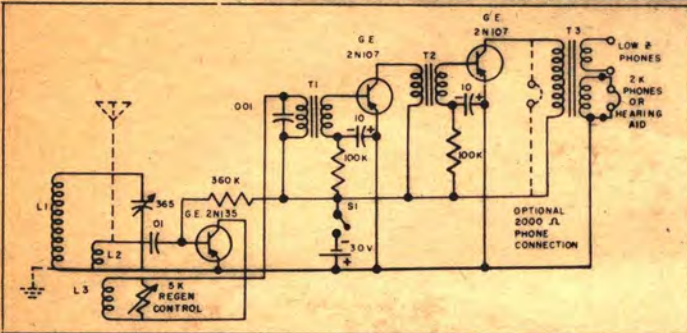

A simple regenerative receiver utilizing 2N135 transistor in RF section and 2N107 transistors for audio. Optimum interstage coupling is achieved with Argonne transistor transformers. High or low impedance earphones may be used. Coils are hand wound as follows:
L1 - 33 turns, #26 enamel wire close wound in loop 5 1/8" x 2 7/8".
L2 - 3 turns #26 enamel wire, wound next to the ground end of L1.
L3 - 5 turns #26 enamel wire, wound over ground end of L1.

LIST OF ESSENTIAL PARTS

Qty	Description	Price Each	Qty	Description	Price Each
1	G.E. 2N135—Transistor	3.95	1	AR-100—T3 for high imp. phones	2.95
2	G.E. 2N107—Transistor @ 1.25	2.50	1	AR-130—T3 for low imp. phones	2.95
1	MS-215—Min. Variable Cond.	.69	1	MS-260—High imp. phones	3.95
2	AR-100—Argonne Trans. T1, T2	@ 2.95	1	MS-100—Low imp. phones	1.95
1	VC-27—Regenerative Control w/s/w.	.69	2	Barco P70—10 Min. 10 mfd Cond.	@ .59 1.18

SOLAR POWERED RADIO

A transistorized receiver powered by sunlight and having an auxiliary mercury power supply. This unit, described in Radio-Electronics March 1956, uses only standard components and achieves excellent sensitivity and selectivity.

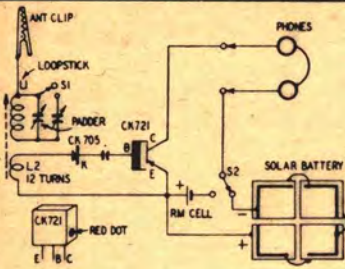

List of Essential Parts

DESCRIPTION	PRICE	DESCRIPTION	PRICE
CK-721 Transistor	2.40	P-82 .1-200V Cond.	.41
CK-705 Diode (1N66)	.65	RM625RT Mercury Cell	.27
B-15 Photocell	6.00	SW14 SPST Slide Switch	.12
C-730 Padder Condenser	.26	MS-72 Earphone	1.95
EFL Loopstick	.90	MS-252 Transistor Socket	.22

SIGNAL TRACING PROBE

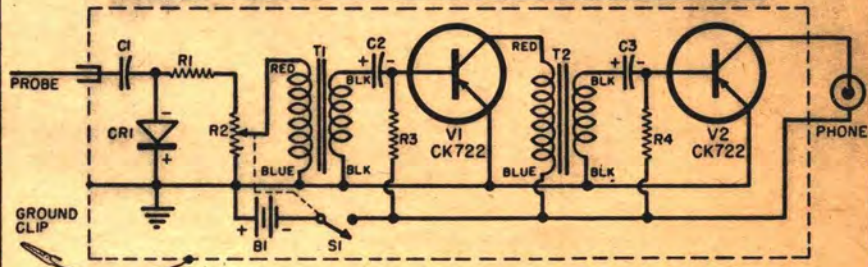

An inexpensive servicing instrument incorporating an RF detector, two stages of audio amplification, a gain control and its own power supply. Article appears in February 1956 issue of Radio & Television News.

LIST OF MAJOR COMPONENTS

Symbol	Description	Net Price Each	Symbol	Description	Net Price Each
V1, V2	CK722 Transistors	.99	R1	220,000 1/2 W Resistor	.05
T1, T2	Argonne A107 Transformers	2.95	R3	100,000 1/2 W Resistor	.05
CR1	1N34 Crystal Diode	.65	R4	4700 1/2 W Resistor	.05
B1	Mallory TR132 Battery	.80	C1	1500 MMf Disc Ceramic Cond.	.09
R2	VC39 - .5 Meg Control w/s/w.	.69	C2, C3	Spragus 1081 - 2mfd 6V Cond.	.58

TRANSISTORIZED SCOPE CALIBRATOR

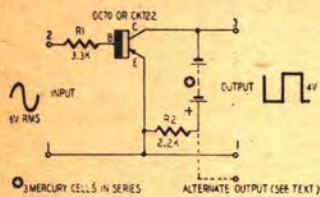

A simple scope calibrator using mercury cells and which provides a more accurate and stable voltage standard than gas regulator calibrators built into expensive oscilloscopes. A minimum of components is required for this precision calibrator which is fully treated in the February 1956 issue of Radio-Electronics.

LIST OF ESSENTIAL PARTS

Qty.	Description	Net Price Each
1	CK722 Transistor	.99
3	Mallory RM625RT Mercury Cells	.27
1	2200 Ohm 1/2 W Resistor	.05
1	3300 Ohm 1/2 W Resistor	.05

RADIO I.F. TESTER

A pocket instrument which is an I.F. signal generator, an audio tone and continuity tester capable of aligning, testing and adjusting superhet receivers.

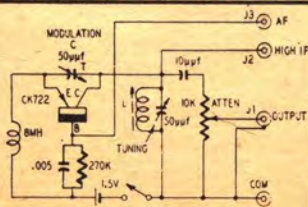

LIST OF ESSENTIAL PARTS

Qty.	Description	Net Price Each
1	CK722 Transistor	.99
1	APC 50 - 50 mmf Air Variable	1.21
1	TS214 - Variable Coil	.29
1	SW10 - SPST Toggle Switch	.30
1	VC34 - 10K Pot	.49
1	C732 - 50 mmf Mica Trimmer	.24
1	Meissner 19-2078 8 MH Choke	.53
1	Aerovox P83Z - .005 Cond.	.26

SCHEMATIC DIAGRAM OF HAZELTINE 7 TRANSISTOR RECEIVER

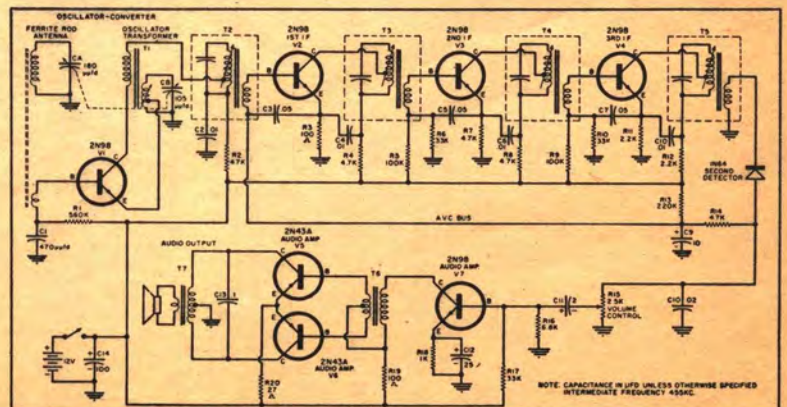

This receiver features three I.F. stages and a Class B push-pull audio output stage. Lafayette's matched subminiature receiver components consisting of the variable condenser MS261, loop antenna MS264, oscillator coil MS265 and matched 455 KC I.F. transformers MS268 and MS269 should be used. Argonne transistor transformers AR101 and AR135 to be used for T6 and T7 respectively.



TRANSISTORS ~ DIODES

RAYTHEON



TEXAS INSTRUMENT



MARVELCO



GENERAL ELECTRIC TRANSISTORS



Type	Class	Net Each	Application	Freq. Cutoff Mc	** α/β	Coll. Dissip. Mw	Pwr. Gain db	DC Coll. Volts	DC Coll. Ma	Coll. Cutoff Ua	Oper. Temp. °C
2N43	p-n-p	7.15	AF	2.5	0.98	150***	44	-45	-50	15	100
2N44	p-n-p	3.95	AF	2.5	0.97	150***	43	-45	-50	15	100
2N45	p-n-p	3.25	AF	2.5	0.94	150***	30	-45	-50	15	100
2N76	p-n-p	2.80	AF	2.5	0.99	50	42	-20	-10	10	60
2N78	n-p-n	3.05	RF-IF	6.0	50	65	65	15	20	6.0	85*
2N81	p-n-p	6.40	AF	6.0	60	50	50	-20	-15	16	100
2N107	p-n-p	1.25	AF	1.0	0.95	50	38	-12	-10	10	60
2N123	p-n-p	7.40	Switch	8.0	0.98	100		-15	-125	6.0	85*
			RF-IF								
2N135	p-n-p	2.70	RF-IF	4.5	20	100		-20	-50	5.0	85*
2N136	p-n-p	3.10	RF-IF	6.5	40	100		-20	-50	5.0	85*
2N137	p-n-p	6.55	RF-IF	10.0	60	100		-10	-50	5.0	85*
2N167	n-p-n	7.85	Switch	8.0	0.975	65		30	75	1.5	85*
2N169	n-p-n	2.65	AF	2.5	20	50		15	20	6.0	75*
2N170	n-p-n	1.75	AF	2.5	20	25	12	6	20	5.0	50*
4JD1A17	p-n-p	6.40	AF	2.5	0.985	150	39	-45	-50	16	85*
USAF 2N43A	p-n-p	6.80	AF	1.0	39	150***	39	-45	50	16	85
2N168	n-p-n	2.90	IF	6.0	20	50	30	15	-20	2	85
2N186	p-n-p	2.70	AF	0.8	24	75†	28	-25	200	16	60
2N186A	p-n-p	3.30	AF	0.8	24	180††	30	-25	200	16	60
2N187	p-n-p	2.95	AF	1.0	36	75†	30	-25	200	16	60
2N187A	p-n-p	3.65	AF	1.0	36	180††	32	-25	200	16	60
2N188	p-n-p	3.40	AF	1.2	54	75†	32	-25	200	16	60
2N188A	p-n-p	4.10	AF	1.2	54	180††	34	-25	200	16	60
2N189	p-n-p	2.45	AF-Driver	.8	24	75	37	-25	50	16	60
2N190	p-n-p	2.65	AF-Driver	1.0	36	75	39	-25	50	16	60
2N191	p-n-p	2.90	AF-Driver	1.2	54	75	41	-25	50	16	60
2N192	p-n-p	3.25	AF-Driver	1.5	75	75	43	-25	50	16	60

1300 Mw Power Output Class B; ††750 Mw Power Output Class B. α/β = Current Amplification; α is decimal, β is whole number.

* Storage Temperature; ** Average rating, all other ratings maximum; *** Power output 45 Mw



RAYTHEON TRANSISTORS



Type	Class	Net Each	Application	* Freq. Cutoff Mc	* α/β	Coll. Dissip. Mw	Power Gain db	Noise db	DC Coll. Volts	DC Coll. Ma	* Coll. Cutoff Ua	Oper. Temp. °C
2N63	p-n-p	3.55	AF-RF	0.6	22	33	39	25	-22	-10	6.0	85
2N64	p-n-p	3.95	AF-RF	0.8	45	33	41	22	-15	-10	6.0	85
2N65	p-n-p	4.35	AF-RF	1.2	90	33	42	20	-12	-10	6.0	85
2N106/CK727	p-n-p	4.35	Low Noise-AF	0.8	25	30	36	12	-6	-10	12	85
2N111/CK759	p-n-p	2.80	RF-IF	3.0	40				-6	-5	1.0	85
2N112/CK760	p-n-p	2.80	RF-IF	5.0	40				-6	-5	1.0	85
2N113/CK761	p-n-p	7.60	RF-IF	10.0	45				-6	-5	1.0	85
2N114/CK762	p-n-p	9.50	RF-IF	20.0	65				-6	-5	1.0	85
2N130	p-n-p	2.05	AF	0.6	22		39	25	-22	-10	6.0	85
2N131	p-n-p	2.05	AF	0.8	45		41	22	-15	-10	6.0	85
2N132	p-n-p	2.05	AF	1.2	90		42	20	-12	-10	6.0	85
2N133	p-n-p	2.40	Low Noise-AF	0.8	45		36	12	-15	-10	12	85
2N138	p-n-p	2.05	AF**		140	50***	30		-12	-20	6.0	40
CK721	p-n-p	2.40	AF-RF	0.8	45		41	22	-15	-10	6.0	70
CK722	p-n-p	.99	AF-RF	0.6	22		39	25	-22	-10	6.0	70
CK725	p-n-p	2.80	AF-RF	1.2	90		42	20	-12	-10	6.0	70
CK790	p-n-p	57.00	Switch, AF	0.4	14	50			-100			135
CK791	p-n-p	92.00	Switch, AF	0.6	24	50			-100			135
CK793	p-n-p	92.00	Switch, AF	0.5	16	50			-100			135

*Average ratings; All other ratings are maximum; **Class β Push-Pull operation;*** Power output; α/β = Current Amplification.

RCA TRANSISTORS



Type	Class	Net Each	Application	Freq. Cutoff Mc	* α/β	Col. Pwr. Dissip. Mw	Power Gain db	* Noise db	* DC Coll. Volts	* DC Coll. Ma	Coll. Cutoff Ua	* Oper. Temp. °C
2N77	p-n-p	2.80	AF	0.7	55	35	41	13	-25	-15	-10	50
2N104	p-n-p	3.15	AF	0.7	44		41	12	-30	-50	-10	70
2N105	p-n-p	2.85	AF	0.75	55	35	42	9	-25	-15	-5	50
2N109	p-n-p	2.10	AF**	7.0	50****		33		-25	-10	-10	50
2N139	p-n-p	2.80	IF	4.7	48	35	30		-16	-15		70
2N140	p-n-p	4.30	Conv.	7.0	45	35	27		-16	-15		70
2N175	p-n-p	7.80	AF***	0.85	65	20	43	6	-10	-2		50

*Maximum rating, all other ratings average; **Large signal audio applications; ***Special low-noise, low-level audio, ****Power Output 160 Mw; α/β = Current Amplification.

GENERAL ELECTRIC DIODES—RECTIFIERS

GENERAL PURPOSE AND T.V.

TYPE	NET	TYPE	NET
1N34A	.80	1N72	1.00
1N38A	1.40	1N73	16.20
1N48	.65	1N74	12.35
*1N48	1.80	1N75	2.65
1N51	.50	*1N75	6.00
1N52	1.40	1N81	1.95
*1N52	3.35	1N285	1.20
1N54A	1.50	1N314	15.85
1N58A	1.45	1N355	1.90
1N63	2.50	G6	2.25
*1N63	6.00	G7A	1.00
1N64	.50	G7B	1.20
1N65	.65	G7C	1.20
1N69	.90	G7D	2.40
1N70	2.40	G7E	2.40

*—Matched Pair

JUNCTION RECTIFIERS

TYPE	NET	TYPE	NET
1N91	1.23	1N153	6.90
1N92	2.88	1N158	9.38
1N93	3.60	1N315	3.96
1N151	4.14	1N368	3.03
1N152	5.35	USNIN 93	3.96

RCA DIODES

TYPE	NET	TYPE	NET
1N34A	.58	1N55A	2.10
1N38A	1.40	1N56A	1.15
1N54A	1.15	1N58A	1.30

SYLVANIA DIODES

TYPE	NET	TYPE	NET
1N21A	2.20	1N78	10.80
1N21B	2.90	1N78A	20.15
*1N21B (2)	8.00	*1N78A (2)	47.50
1N21BR	5.75	1N78R	15.70
*1N21B	14.00	1N79	2.50
1N21BR		1N81	1.05
1N21C	5.05	1N82	.90
*1N21C (2)	15.00	1N82A	1.00
1N21D	18.00	1N105	.50
1N23A	1.10	1N109	.50
1N23B	1.85	1N111	1.30
*1N23B (2)	4.30	1N112	1.05
1N23BR	4.30	1N113	1.65
*1N23B	10.80	1N114	1.05
1N23BR		1N115	.95
1N23C	3.65	1N120	1.10
1N23CR	9.40	1N132	.50
*1N23C (2)	14.40	1N137A	3.85
*1N23C	25.90	1N138A	3.85
1N23CR		1N160	5.75
1N23D	36.00	1N172	1.05
1N23DR	50.00	1N193	5.75
*1N23D	107.75	1N194	6.75
1N23DR		1N195	6.85
1N25	5.75	1N196	10.05
1N26	10.10	1N200	5.05
1N31	7.20	1N201	5.05
1N32	14.50	1N202	5.05
1N34A	.75	1N203	5.05
1N35	2.20	1N204	5.05
1N38A	1.30	1N205	5.05
1N39	3.95	1N206	5.05
1N39A	4.70	1N207	5.05
1N40	12.25	1N208	5.05
1N41	11.50	1N209	5.05
1N42	17.25	1N210	5.05
1N53	43.15	1N211	5.05
*1N53 (2)	104.95	1N212	5.05
1N54A	1.05	1N213	5.05
1N55A	2.10	1N214	5.05
1N56	1.05	1N215	5.05
1N56A	1.10	1N216	7.20
1N58A	1.30	1N217	7.20
1N59	4.30	1N218	7.20
1N59A	5.05	1N219	7.20
1N60	.50	1N220	7.20
1N63	1.65	1N221	7.20
1N64	.50	1N222	7.20
1N65	.65	1N401	5.05
1N67	1.65	1N402	5.05
1N69	.75	1N403	5.05
1N70	2.25	1N404	5.05
1N71	7.20	1N405	5.05
1N72	1.00	1N406	5.05
1N76	4.30	1N407	5.05
1N77A	36.75	1N408	5.05

*Matched Pair

TRANSISTORS - DIODES



RAYTHEON



TEXAS INSTRUMENT

HUGHES



MARVELCO



RAYTHEON DIODES

TYPE	NET	TYPE	NET
1N34	.65	CK715	.65
1N66	.65	CK717	9.40
1N67	1.57	CK719	9.40
1N68	1.57	CK735	Use 1N300
1N294	.70	CK735A	Use 1N300A
1N295	.41	CK736	Use 1N301
1N297	1.35	CK736A	Use 1N301A
1N298	.95	CK737	Use 1N302
1N300	5.55	CK737A	Use 1N302A
1N300A	6.55	CK738	Use 1N303
1N301	5.55	CK738A	Use 1N303A
1N301A	6.35	CK739	Use 1N305
1N302	6.35	CK740	Use 1N306
1N302A	7.90	CK742	Use 1N307
1N303	5.55	CK775	34.50
1N303A	6.35	CK776	41.50
1N305	2.00	CK801	2.00
1N306	2.00	CK802	2.00
1N307	2.60	CK840	12.50
1N432	5.55	CK841	12.50
1N432A	6.35	CK842	14.75
1N433	5.55	CK843	15.50
1N433A	7.00	CK844	16.50
1N434	5.55	CK845	20.50
1N434A	7.00	CK850	Use 1N436
1N436	5.55	CK851	Use 1N437
1N438	5.55	CK852	Use 1N438
1N439	5.55	CK853	Use 1N439
1N460	5.55	CK856	Use 1N432
1N460A	6.35	CK856A	Use 1N432A
CK705	Use 1N66	CK858	Use 1N460
CK705A	Use 1N294	CK858A	Use 1N460A
CK706A	Use 1N295	CK860	Use 1N433
CK707	Use 1N67	CK860A	Use 1N433A
CK708	Use 1N68	CK861	Use 1N434
CK709	9.40	CK861A	Use 1N434A
CK710	.87	CK863	9.40
CK711	9.40	CK863A	11.00
CK713A	Use 1N298		

HUGHES GERMANIUM DIODES

Type	Net Each	Type	Net Each
1N55B	5.04	1N118	1.16
1N68A	1.07	1N90	.55
1N67A	1.56	1N95	.65
1N99	1.62	1N96	.85
1N100	2.47	1N126*	.72
1N89	.55	1N127**	1.20
1N97	1.82	1N128***	1.01
1N98	1.66	1N198	2.02
1N116	.88	1N191	1.62
1N117	1.11	1N92	1.14

* Formerly 1N69A; ** Formerly 1N70A; *** Formerly 1N81A

HUGHES SILICON JUNCTION DIODES

Type	Net Each	Type	Net Each
HD6001	2.60	HD6007	5.53
HD6002	3.90	HD6008	5.85
HD6003	4.23	HD6009	4.06
HD6005	5.04	HD6011	5.69
HD6006	5.20		

RAYTHEON RF TRANSISTOR

High Frequency Type
Cut-Off Frequency
Prox 3MC



CK-768 1.50



MARVELCO TRANSISTORS



Type	Class	Net Each	Appli- cation	Freq. Cutoff Mc	α/β	Coll. Pwr. Dissip. Mw	Pwr. Gain db	Pwr. Output Mw	Noise db	DC Coll. Volts	DC Coll. Ma	Coll. Cutoff Ua	Temp. °C
HF-1	p-n-p	3.65	RF-IF	5.0	0.975	75	28***		22	-20	-8	5	55
HF-2	p-n-p	3.50	RF-IF	10.0	0.975	75	28		22	-12	-8	5	55
IF-*	p-n-p	3.50	RF-IF	3.0	0.985	75	40		11	-25	-8	5	55
IF-2	p-n-p	3.00	RF-IF	3.0	0.97	75	37.5		22	-25	-8	10	55
IF-3	p-n-p	2.00	RF-IF	3.0	0.96	75	35		22	-25	-8	10	55
JP-1	p-n-p	4.75	POWER		0.90	350**		350**	15	-45	-50**	500	55
						500**		400**			-100**		
J-1	p-n-p	1.80	AUDIO		0.97	150	40		11	-40	-10	15	55
J-2	p-n-p	1.60	AUDIO		0.94	150	35		22	-40	-10	15	55
J3	p-n-p	1.50	AUDIO		0.90	150	30		33	-40	-10	20	55
CQ-1	p-n-p	1.25	AUDIO		0.90	150	28.5		33	-40	-10	20	50
RF-1	p-n-p	1.50	RF-IF	2.5	0.94	75	32.5		33	-15	-8	10	50

All ratings max. except Freq. Cutoff and α/β (Current Amplification) are minimum.

* Ambient temperature. ** In Free Air, Higher figure with chassis attachment (heat sink), 1.5 Watt output in DC Switching Circuits (with heat sink). *** At 455kc; Gain at 2 Mc 16.5 db for HF-1, 19.5 db for HF-2.



TEXAS INSTRUMENT TRANSISTORS



Type	Class	Net Each	Appli- cation	Freq. Cutoff Mc	α/β	Coll. Pwr. Dissip. Mw	Power Gain db	Noise db	DC Coll. Volts	DC Coll. Ma	Coll. Cutoff Ua	Oper. Temp. °C
300	p-n-p	1.72	AF	0.7	19	100		40	-30	-50	10	75
301	p-n-p	2.32	AF	1.0	49	100		35	-30	-50	10	75
302	p-n-p	2.72	AF	1.3	55	100		33	-30	-50	10	75
310	p-n-p	2.36	AF-Driver	1.0		2***	37		-20		20	60
353	p-n-p	2.80	AF P-P			100****	23		-20	-150	15	75
903	n-p-n Si*	13.50	RF-Conv.	4.0	0.975	150	30.5	25	30	25	10	175
904	n-p-n Si	27.00	RF-Conv.	5.0	0.975	150	34	25	30	25	10	175
904A	n-p-n Si	36.00	RF-Conv.	8.0	1.000	150	35	25	30	25	10	175
905	n-p-n Si	36.00	RF-Conv.	6.0	1.000	150	36.5	25	30	25	10	175
951	n-p-n Si	27.00	AF-Servo		1.000	1000	30	50	60*	5	175	
952	n-p-n Si	27.00	AF-Servo		1.000	1000	30	80	50	6	175	
953	n-p-n Si	27.00	AF-Servo		1.000	1000	30	120	40	8	175	
970	n-p-n Si	27.00	Servo			8.75W	28	120	120	140	10	150
2N124	n-p-n	4.52	Switch	3.0	24	50		20	10	8	2	75
2N125	n-p-n	6.32	Switch	5.0	48	50		20	10	8	2	75
2N126	n-p-n	8.08	Switch	5.0	100	50		20	10	8	2	75
2N145	n-p-n	4.04	IF			65	33	20	5	3	75	
2N146	n-p-n	4.52	IF			65	36	20	5	3	75	
2N147	n-p-n	5.40	IF			65	39	20	5	3	75	
2N172	n-p-n	4.88	Conv.			65		16	5	3	75	
2N185/ 352	p-n-p	2.48	Audio		55	150****	40.5		-20	-150	15	50

All ratings are maximum. *Silicon - high temperature, low-level, high gain; **In free air; ***Power Output; ****250 Mw Power Output.

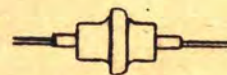

HUGHES GERMANIUM TRANSISTORS



TYPE	Class	Net Each	Appli- cation	Freq. Cutoff Mc	α	Col. Pwr. Dissip. Mw	Noise db	DC Coll. Volts	DC Coll. Ma	Coll. Cutoff Ua	Oper. Temp. °C
HA5001	n-p-n	9.10	Computer-RF	2.5	1.0	500	0.2 μ sec*	30	100	10	85
HA5002	n-p-n	5.20	IF-Audio	1.0	0.965	500	18	20	100	10	85
HA5003	n-p-n	6.50	IF-Audio	1.5	0.99	500	18	20	100	10	85

ALL RATINGS MAX. *Rise Time (micro seconds).



SYLVANIA TRANSISTORS



Type	Class	Net Each	Appli- cation	Freq. Cutoff Mc	α/β	Coll. Pwr. Dissip. Mw	Power Gain db	Power Output Mw	DC Coll. Volts	DC Coll. Ma	Coll. Cutoff Ua	Oper. Temp. °C
2N34	p-n-p	3.15	AF-Switch	0.6	40	50	40	125****	-25	-10	5.0	25
2N35	n-p-n	2.55	AF-Switch	0.8	40	50	40	125****	25	10	5.0	25
2N68	p-n-p	6.50	AF-Power	0.4	0.975	2.5W**	23	600***	-25	-1.5 Amp.	100	25
						4.0W						
2N94	n-p-n	2.85	RF-IF	3.5	0.97	50		20	10		3.0	25
2N94A	n-p-n	5.05	RF-IF	6.0	0.97	50		20	10		3.0	25
2N95	n-p-n	6.50	AF-Power	0.4	0.975	2.0W**	23	600***	25	1.5 Amp.	100	25
						4.0W						
2N101	p-n-p	6.90	AF-Power	0.4	0.975	1.0W**	23	600***	-25	-1.5 Amp.	100	25
						4.0W						
2N102	n-p-n	6.50	AF-Power	0.4	0.975	1.0W**	23	600***	25	1.5 Amp.	100	25
						4.0W						

*Maximum ratings, all others are average; Temperature is ambient. ** In Free Air, 4.0W with heat sink. ***Class A, 5 watt Push Pull Class B (Common Emitter or Collector), 10 Watts (Common Base), 12 Watts (Switching). ****Class B, Push-Pull (2 Units); α/β = Current Amplification.

Argonne TRANSISTOR TRANSFORMERS

AT LAST A COMPLETE LINE OF QUALITY TRANSFORMERS FOR EVERY TRANSISTOR APPLICATION AT A PRACTICAL PRICE!

• Nickel-Steel and Silicon Steel Laminations • Wound on Nylon Bobbins • Mylar Outer Wrap • Color Coded Leads

Have you been experimenting with transistor circuits? And have you been forced to make-do with compromise transformers or improvised units? And have you had to pay from \$6.00 to \$12.00 for them? The Argonne line brings you a wide variety for experimentation as well as for replacement. Efficiently designed to meet the needs of miniaturization and engineered to provide more power, handling capacity and improved frequency response with minimum distortion. All are nickel-steel laminations except asterisk which are silicon steel. Average net weight 1 1/4 oz; average shipping wt. 4 ozs.

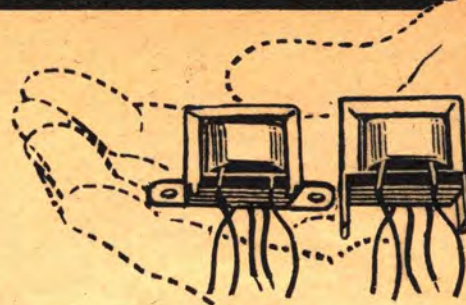

ANY TYPE

2.75 each

Lots of 10 Assorted

2.95

single, each

ARGONNE NUMBER	TYPE	IMPEDANCE		UNBALANCED CURRENT PRI D.C. MA	POWER MILLI-WATTS	D.C. RESISTANCE		OVERALL SIZE
		PRI-MARY OHMS	SECONDARY OHMS			PRI. OHMS	SEC. OHMS	
AR-100	Input	200,000	1,000	.0	100	3600	90	1" x 3/4" x 3/8"
AR-126	Input	150,000	1,500 CT	2.	100	3700	55	1" x 3/4" x 3/8"
AR-101	Input	100,000	3,000 CT	.5	100	3600	60	1" x 3/4" x 3/8"
AR-102	Input	100,000	1,500 CT	.5	100	3600	40	1" x 3/4" x 3/8"
AR-127	Input	50,000	3,000 CT	1.	100	2000	50	1" x 3/4" x 3/8"
AR-128	Input	50,000	1,500 CT	2.	100	3000	50	1" x 3/4" x 3/8"
AR-129	Input	50,000	1,000	2.	100	2500	20	1" x 3/4" x 3/8"
AR-103	Driver	20,000	2,000 CT	1.	100	400	50	1" x 3/4" x 3/8"
AR-104	Driver	20,000	1,000	.0	100	400	50	3/4" x 3/8" x 3/8"
AR-105	Driver	20,000	400	1.	100	600	30	1" x 3/4" x 3/8"
AR-130	Output	20,000	8	.5	100	400	0.6	3/4" x 3/8" x 3/8"
AR-131	Output	20,000	3.2	.5	100	400	0.3	3/4" x 3/8" x 3/8"
AR-106	Driver	16,000	4,000	1.	100	620	350	3/4" x 3/8" x 3/8"
AR-107	Driver	15,000	200	1.5	250	1000	20	1" x 3/4" x 3/8"
AR-108	Driver	10,000	3,000 CT	.0	100	200	100	3/4" x 3/8" x 3/8"
AR-109	Driver	10,000	2,000 CT	.0	100	500	50	3/4" x 3/8" x 3/8"
AR-110	Output	10,000	16	2.	150	600	2.5	3/4" x 3/8" x 3/8"
AR-132	Output	10,000	8	1.	100	600	.6	3/4" x 3/8" x 3/8"
AR-133	Output	10,000	3.2	1.	100	600	.3	3/4" x 3/8" x 3/8"
AR-111	Output	5,000	100	1.	100	600	10	3/4" x 3/8" x 3/8"
AR-134	Output	4,000 CT	8	4.	250	150	.8	1" x 3/4" x 3/8"
AR-135	Output	4,000 CT	3.2	4.	250	150	.3	1" x 3/4" x 3/8"
AR-112	Output	3,500	200	1.	150	120	25	1" x 3/4" x 3/8"
AR-113*	Driver	3,000 CT	1,000	9.	150	100	60	3/4" x 3/8" x 3/8"
AR-114	Output	2,500	11	10.	150	50	1.1	3/4" x 3/8" x 3/8"
AR-115	Input	2,000 CT	8,000 CT	.0	150	150	660	1" x 3/4" x 3/8"
AR-116	Output	2,000	200	4.	250	120	20	1" x 3/4" x 3/8"
AR-136*	Output	1,000 CT	100	4.	250	120	10	1" x 3/4" x 3/8"
AR-137*	Output	1,000 CT	8	4.	250	120	.9	1" x 3/4" x 3/8"
AR-138*	Output	1,000 CT	3.2	4.	250	120	.3	1" x 3/4" x 3/8"
AR-117	Output	500 CT	30	.0	100	20	1.5	3/4" x 3/8" x 3/8"
AR-118	Output	500 CT	16	.0	100	20	1.5	3/4" x 3/8" x 3/8"
AR-119	Output	500 CT	3.2	.0	100	20	.3	3/4" x 3/8" x 3/8"
AR-120*	Output	400 CT	11	1.	150	20	.9	3/4" x 3/8" x 3/8"
AR-121*	Output	300 CT	3.2	.0	150	20	.25	3/4" x 3/8" x 3/8"
AR-139*	Output	250 CT	8	2.	250	15	.7	1" x 3/4" x 3/8"
AR-122*	Output	250 CT	3.2	.0	150	11	.3	1" x 3/4" x 3/8"
AR-123	Input	200	2,000 CT	2.	150	11	50	1" x 3/4" x 3/8"
AR-124*	Output	200 CT	16	.0	250	20	1.3	3/4" x 3/8" x 3/8"
AR-140*	Output	200 CT	3.2	2.	100	10	.3	3/4" x 3/8" x 3/8"
AR-125	Input	3	4,000	.0	250	.14	50	3/4" x 3/8" x 3/8"

UTC SUBOUNCER AND SUB-SUBOUNCER TRANSFORMERS



For hearing aids, vest pocket radios, midget devices and other ultra-miniature equipment. Average frequency response 200-10,000 cps ± 3 db. High efficiency obtained through special nickel iron core materials and winding methods. Cellulose acetate insulation; 4 color-coded leads. SO dimensions: 9/16 x 3/8 x 3/16"; SSO, 7/16 x 3/4 x 3/16". Average shpg. wt. 2 oz. SO indicates sub-ouncer units and SSO sub-sub-ouncer. Fixed impedance ratio; 1250:1 for SO-1 and SSO-1; 1:50 for SO-3 and SSO-3; SO-5, 3000 ohms DC resistance; SSO-5, 4400 ohms.

Type	Use	Pri. Imp.	Pri. DC	Sec. Imp.	NET
SO-1	Input	200, 50	0	250K, 62.5K	3.92
SO-2	Audio, 1:3	10,000	0-.25 ma	90K	3.53
SO-3	Pl. to line	10K, 25K	3, 1.5 ma	200, 500	3.53
SO-4	Output	30,000	1 ma	50	3.53
SO-5	Reactor	50 hys @	1 ma DC*		2.94
SO-6	Output	100,000	.5 ma	60	3.92
SO-7	Interstage	20K, 30K	.5; .5 ma	800, 1200	3.00
SO-8	Interstage, PP Sec.	10,000	1 ma	2,000 CT	4.20
SO-9	Output, PP	500 CT	0 ma	3.2	3.60

SUBOUNCER TRANSFORMERS

SUB-SUBOUNCER TRANSFORMERS

Type	Use	Pri. Imp.	Pri. DC	Sec. Imp.	Net
SSO-1	Input	200, 50	0	250K, 62.5K	4.12
SSO-2	Audio, 1:3	10,000	0-.25 ma	90K	4.41
SSO-3	Pl. to line	10K, 25K	3, 1.5 ma	200, 500	3.63
SSO-4	Output	30,000	1 ma	50	3.63
SSO-5	Reactor	50 hys @	ma DC*		3.63
SSO-6	Output	100,000	.5 ma	60	3.63
SSO-7	Interstage	20K; 30K	.5; .5 ma	800; 1200	3.00
SSO-8	Interstage, PP Sec.	10,000	1 ma	2000 CT	4.20
SSO-9	Output	10,000	2 ma	16	3.00
SSO-10	Output	10,000	2 ma	3.2	3.00
SSO-11	Output	500; 600	3.5; 3.5	50; 60	3.00
SSO-12	Output	1K; 1.2K	3.3 ma	50; 60	3.00
SSO-13	Crystal Input	200,000	0 ma	1,000	4.50

UTC DOTS . . . TRANSISTOR TRANSFORMERS

5/16" DIA. . . . 13/32" LONG . . . 1/10th OZ. WEIGHT. High power rating, excellent response, low distortion, high efficiency, moisture proof, rugged, anchored leads.

Type	Use	Level Mw	Pri. Imp.	Pri. DC	Sec. Imp.	Net
DOT-1	Interstage	50	30K; 20K	5; .5 ma	1200; 800	5.88
DOT-2	Output	100	600; 500	3; 3 ma	60; 50	5.19
DOT-3	Output	100	1200; 1000	3; 3 ma	60; 50	5.19
DOT-4	Output	100	600	3 ma	3.2	5.19
DOT-5	Output	100	1200	2 ma	3.2	5.19
DOT-6	Output	100	10,000	1 ma	3.2	5.88
DOT-7	Input	25	200,000	0 ma	1000	6.47
DOT-8	Reactor					4.70

TRANSISTOR AUDIO TRANSFORMER

1.69

Subminiature, compact, high grade transistor audio transformers.

No.	Type	Pri.	Sec.	Size	Net
TR-79	Driver	7,500	1,000	3/4" x 1" x 3/8"	1.69
TR-80	Driver	10,000	2,000	3/4" x 3/4" x 3/8"	1.69
TR-81	Interstage	5,000	1,000	3/4" x 3/4" x 3/8"	1.69
TR-82	Driver	16,000	2,000	3/4" x 3/4" x 3/8"	1.69
TR-83	Output	500	3.2	3/4" x 3/4" x 3/8"	1.69
TR-86	Push-Pull Output	330	12	3/4" x 1" x 3/8"	1.69
Transistor Audio - For Power Transformers - 5 Watt					
TR-84	Output	48	3.2	1-9/16" x 1 1/8" x 1-9/16"	1.69
TR-85	Driver	100	200	1 1/4" x 1 1/2" x 1 1/4"	1.69





LAFAYETTE SPECIALIZES IN MINIATURE PARTS FOR TRANSISTOR CIRCUITS



TRANSISTOR ULTRA-MINIATURE ELECTROLYTIC CONDENSERS

7/32" Diameter — 25/32" Long

Latest subminiature electrolytic capacitors. Hermetically sealed aluminum cases, especially suitable physically and electrically for application in transistor and miniature electronic circuits. Long shelf-life, stable capacity and low leakage current. Super value in ultra-miniature electrolytics.

Cat. No.	Description	Dia.	Length	Price
CF-100	2 - mfd 6 Volt	7/32"	25/32"	.29
CF-101	4 - mfd 6 Volt	7/32"	25/32"	.29
CF-102	8 - mfd 6 Volt	7/32"	25/32"	.29
CF-103	10 - mfd 6 Volt	9/32"	25/32"	.29
CF-104	30 - mfd 6 Volt	9/32"	25/32"	.29
CF-105	50 - mfd 6 Volt	11/32"	25/32"	.35
CF-106	100 - mfd 6 Volt	11/32"	25/32"	.35
CF-120	2 - mfd 15 Volt	7/32"	1-7/32"	.39
CF-121	6 - mfd 15 Volt	7/32"	25/32"	.31
CF-122	10 - mfd 15 Volt	9/32"	25/32"	.33
CF-123	20 - mfd 15 Volt	13/32"	25/32"	.33
CF-124	30 - mfd 15 Volt	13/32"	25/32"	.33
CF-125	50 - mfd 15 Volt	15/32"	25/32"	.36
CF-126	100 - mfd 15 Volt	16/32"	1-12/32"	.45
CF-140	2 - mfd 25 Volt	7/32"	25/32"	.29
CF-141	6 - mfd 25 Volt	11/32"	25/32"	.29
CF-142	10 - mfd 25 Volt	11/32"	25/32"	.31
CF-143	25 - mfd 25 Volt	13/32"	25/32"	.35
CF-144	50 - mfd 25 Volt	13/32"	27/32"	.40

TRANSISTOR SOCKETS



• A LIFESAVER FOR YOUR TRANSISTORS!

Transistors may be damaged by the heat of soldering. The utilization of these specially developed transistor sockets prolongs the life of your transistor. Moulded from mica-filled low loss bakelite. Silver plated beryllium copper contacts. *For printed circuits. Size is overall.

Stock No.	Type	Cont.	Size	Net
MS-275	A	3	15/32"x11/32"x7/32"	.19
MS-253	A	5	15/32"x11/32"x7/32"	.19
MS-252	B	5	1/4" x 3/16"x3/8"	.22
MS-149*	C	5	1/4" x 3/16"x 3/8"	.22

SUBMINIATURE SOCKETS



Used in all subminiature radios, hearing aids and electronic devices that require subminiature tubes. Mica-filled low-loss bakelite. Silver-plated beryllium copper contacts. Shpg. wt. 2 oz. Size is overall.

Stock No.	Type	Cont.	Size	Net
MS-253	A	5	15/32"x11/32"x7/32"	.19
MS-254	A	6	13/32"x7/32"x9/32"	.19
MS-255	A	7	31/64"x7/32"x5/32"	.22
MS-256	B	8	13/32"x7/16"	.39

B & W MINIDUCTORS

Air wound, polystyrene insulation. Easily cut to size. All are 2" Long except 1" Diameter are 3"

Diam.	4 Turns		8 Turns		16 Turns		32 Turns		Net
	Type	Per In.	Type	Per In.	Type	Per In.	Type	Per In.	
1/2"	3001	3002	3003	3004	.36				
3/8"	3005	3006	3007	3008	.45				
5/8"	3009	3010	3011	3012	.54				
1"	3013	3014	3015	3016	.60				

SPRAGUE TRANSISTOR ULTRA-MINIATURE ELECTROLYTIC CONDENSERS

3/16" Diameter 1/2" Long



A New approach to reliability in reasonably-priced sub-miniature electrolytic capacitors. Smallest hermetically-sealed aluminum electrolytic capacitors made — They'll fit anywhere and work anywhere. Extremely low leakage current, long shelf life. Excellent replacement capacitors for transistorized radio sets presently on the market. Ideal for applications in Hearing Aids and other Miniature Electronic Equipment.

Catalog No.	Capacity	WVDC	Diam.	Length	Net
TE-1010	5 mfd	1	3/16	9/16	.58
TE-1055	25	3	1/4	5/8	.58
TE-1060	110	3	3/8	3/4	.65
TE-1080	1	6	3/16	1/2	.58
TE-1081	2	6	3/16	1/2	.58
TE-1082	3	6	3/16	1/2	.58
TE-1083	4	6	3/16	1/2	.58
TE-1084	5	6	3/16	1/2	.58
TE-1086	8	6	1/4	3/4	.61
TE-1087	10	6	1/4	3/4	.61
TE-1089	15	6	1/4	3/4	.61
TE-1091	25	6	1/4	3/4	.61
TE-1092	30	6	3/8	3/4	.65
TE-1095	40	6	3/8	3/4	.65
TE-1100	50	6	3/8	3/4	.65
TE-1101	60	6	3/8	3/4	.65
TE-1116	15	10	1/4	3/4	.61
TE-1118	25	10	1/4	3/4	.61
TE-1127	5	12	1/4	3/4	.61
TE-1128	10	12	1/4	3/4	.61
TE-1202	5	25	1/4	3/4	.65
TE-1203	6	25	1/4	3/4	.65
TE-1204	10	25	3/8	3/4	.67
TE-1205	15	25	3/8	3/4	.67

CAMBRIDGE THERMIONIC CORPORATION SLUG-TUNED COILS



For TV traps, broadband RF amplifiers, general HF circuits, etc. Coil bodies of LSM, LS3 and LS4 are HF paper base phenolic; LS5 and LS6 are ceramic. LS3 has larger slug and greater bandpass. LS4 for larger inductance and Q. Slugs tunable from either end. Locking feature. Sizes: LSM, 27/32x1/4" dia.; LS3, 1 1/8x3/8" dia.; LS4, 2x1/2" dia.; LS5, 1-1/16x3/8" dia.; LS6, 27/32x1/4" dia. Wt., 4 oz.

Type	Description	Net
LS3	Coil Form	.53
LS3	1 Mc Coil	1.02
LS3	5 Mc Coil	.92
LS3	10 Mc Coil	.95
LS3	30 Mc Coil	.90
LS3	60 Mc Coil	.90
LSM	Coil Form	.53
LSM	1 Mc Coil	1.00
LSM	5 Mc Coil	.95
LSM	10 Mc Coil	.90
LSM	30 Mc Coil	.90
LSM	60 Mc Coil	.90
LS4	Coil Form	.72
LS5	Coil Form	.70
LS6	Coil Form	.63

CAMBRIDGE THERMIONIC PRINTED CIRCUIT COIL FORMS



An internally threaded phenolic tube with collars and solder lugs, with powdered iron core that is adjustable from either end of the form. A simple vertical mounting by punching two to four holes in board. Winding area on form is 11/16" long. Types SPC1 have 5/16" core, Types SPC2 have 3/8" core.

Type No.	Tube Diam.	O.D.	Number of Lugs	Net
SPC1-A-2L	.219"	.356"	2	.29
SPC1-A-3L	.219"	.356"	3	.29
SPC1-A-4L	.219"	.356"	4	.29
SPC2-B-2L	.285"	.426"	2	.29
SPC2-B-3L	.285"	.426"	3	.29
SPC2-B-4L	.285"	.426"	4	.29

MINIATURE KNOB



Plastic knob, only 3/8" diameter fits 1/8" shafts, for miniature components such as Ferri-loopstock, sub-miniature pots, etc. MS-185 Net 7¢

BARCO TRANSISTOR ULTRA-MINIATURE ELECTROLYTIC CONDENSERS

1/8" Diameter — 3/8" Long



For applications in Transistor and Miniature Electronic Circuits, small hermetically-sealed aluminum electrolytic condensers. Low-leakage current, stable capacity. Will fit anywhere.

Type	Capacity	W.V.	Diam.	Length	Net
P25-.25	1/4 mfd	25V	1/8"	3/8"	.59
P25-.4	4 mfd	25V	1/8"	3/8"	.59
PT12-1	1 mfd	12V	1/8"	1/2"	.59
PT6-2	2 mfd	6V	11/64"	11/16"	.44
P6-8	8 mfd	6V	11/64"	11/16"	.44
P58-5	5 mfd	8V	11/64"	11/16"	.44
P520-2	2 mfd	20V	11/64"	11/16"	.44
PT12-2	2 mfd	12V	3/16"	17/32"	.44
P6-25	25 mfd	6V	1/4"	11/16"	.44
P12-16	16 mfd	12V	1/4"	11/16"	.44
P25-8	8 mfd	25V	1/4"	11/16"	.44
P40-5	5 mfd	40V	1/4"	11/16"	.44
P70-3	3 mfd	70V	1/4"	11/16"	.44
P6-80	80 mfd	6V	23/64"	11/16"	.59
P25-25	25 mfd	25V	23/64"	11/16"	.59
P40-16	16 mfd	40V	23/64"	11/16"	.59
P70-10	10 mfd	70V	23/64"	11/16"	.59
P6-160	160 mfd	6V	23/64"	1-9/32"	.73
P25-50	50 mfd	25V	23/64"	1-9/32"	.73
P40-30	30 mfd	40V	23/64"	1-9/32"	.73
P70-20	20 mfd	70V	23/64"	1-9/32"	.73

AEROVOX TYPE P82 METALLIZED-PAPER CAPACITORS



Tiny AeroVox Metallized-Paper tubular units are self-healing to protect against surge voltages. Hyvol K impregnated. In moisture resistant wax impregnated cardboard cases. Up to 78% smaller than equivalent paper units. Standard Tolerance ±20%. Shpg. Wt. 2 oz.

200 VOLTS			400 VOLTS		
Mfd.	Size	Each	Mfd.	Size	Each
.01	3/8x3/8"	.35	.01	3/8x3/8"	.38
.02	3/8x3/8"	.35	.02	3/8x3/8"	.38
.03	3/8x3/8"	.35	.03	3/8x3/8"	.38
.05	3/8x3/8"	.38	.05	3/8x3/8"	.41
.1	3/8x3/8"	.41	.1	3/8x3/8"	.47
.25	3/8x3/8"	.53	.25	3/8x3/8"	.59
.5	1/2x1 1/8"	.62	.5	1/2x1 1/8"	.68
1.0	1/2x1 1/8"	.76	1.0	1/2x2 1/8"	.94
2.0	3/4x1 1/8"	1.06			

AEROVOX TYPE P83Z MICRO-MINIATURES

Ultra-small metallized-dielectric capacitor particularly suited to replace the low capacity paper units now used. Hyvol K impregnated in humidity-resistant molded thermo-plastic cases. Shpg. Wt. 1 oz.

200 VOLTS			400 VOLTS		
Mfd.	Size	Each	Mfd.	Size	Each
.005	1/8x1/8"	.26	.002	1/8x1/8"	.26
.01	1/8x1/8"	.26	.003	1/8x1/8"	.26
.02	1/8x1/8"	.32	.01	1/8x1/8"	.32
.04	1/8x1/8"	.32			

CENTRALAB TYPE DM MIN-KAPS

Miniature capacitors for use where space is at a premium as in coils, pocket radios, hearing aids, etc. 17/32" long, 7/32" wide, 7/64" thick. Tolerance: .001 mfd to .002 mfd —20% +50%; .003 mfd to .01 mfd —20% +80%.



150 VOLTS D.C.W.			150 VOLTS D.C.W.		
Cap. Mfd.	Cat. No.	Net	Cap. Mfd.	Cat. No.	Net
.0001	DM-101	.21	.002	DM-202	.26
.0002	DM-201	.21	.003	DM-302	.26
.0003	DM-301	.21	.005	DM-502	.26
.0005	DM-501	.21	.01	DM-103	.38
.001	DM-102	.21	2X.005	DM2-502	.38



LAFAYETTE SPECIALIZES IN MINIATURE PARTS FOR TRANSISTOR CIRCUITS



SUBMINIATURE VOLUME CONTROLS



For Transistor & Subminiature Tube Circuits with S.P.S.T. Switch Size 23/32" Dia. 1/2" Deep.

The ultra small volume control is a positive marvel of engineering skill. Designed with today's trend toward miniaturization. It forms a perfect complement to subminiature transistor and tube circuits. Switch rating 6.5 amp at 1.5 Volt, 2 amps at 45 Volt. Size: Dia 23/32"; only 1/2" deep.

With S.P.S.T. Switch

VC-42 - 5,000 ohm
VC-43 - 10,000 ohm
VC-44 - 15,000 ohm
VC-45 - 25,000 ohm
VC-46 - 1/2 Meg
VC-47 - 1 Meg

79¢

in lots of 10

89¢ single each

HIGH-GAIN LOOPSTICK ANTENNAS



An excellent selection of highly efficient, low-cost, ferrite core antennas. Give high gain across complete broadcast band from 540 to 1600 KC when tuned with standard 365 mmf tuning condenser. Ideal as replacements for bulky, old-fashioned loop antennas on back of AM broadcast receivers. Give sensitive reception from all directions—you don't have to rotate your radio to pick up weak stations.

A. VARI-LOOPSTICK. A revolutionary antenna development. An extremely small yet very powerful replacement antenna with a "Q" of 240-275. Boosts sensitivity and signal to noise ratio considerably in portable receivers. With adjustable ferrite core for maximum peaking efficiency and precise tracking on entire broadcast band. Single hole snap-in mounting, plus mounting bracket. Equally efficient at any angle. 2 1/4" x 7/16". Shpg. wt., 4 oz.
MS-11 In lots of 10, Each 36¢
Singly, Each 39¢

B. ENERGIZED FERRI-LOOPSTICK. New 5" ferrite rod loopstick antenna with a "Q" of up to 350. Extremely high gain brings in even distant stations not normally received. New type adjustable coil with self-locking vinyl collar permits peaking antenna for super sensitive results. 3/8" x 5". Shpg. wt., 6 oz.
MS-287 Net 88¢

C. 7" SUPER LOOP. Super sensitive ferrite loopstick antenna with a "Q" of up to 425. Excellent for replacement of old style loops. Brings in even hard to get stations with incomparable ease. Adjustable for maximum sensitivity over length of 7 in. Complete with mount. Shpg. wt., 6 oz.
MS-44 Net 1.32

SYLVANIA TRANSISTOR KIT



COMPLETE KIT 4.95

For The Experimenter

The Sylvania Transistor Kit is supplied with the Transistor. Booklet "28 USES FOR JUNCTION TRANSISTORS," TWO Type 2N35 Transistors and one type 1N34A General Purpose Diode. Complete transistor circuits and detailed instructions make this kit easy to use. Ideal for the experimenter who wants to get the feel of transistorized circuits.

KIT Complete Kit **4.95**

TRANSISTOR POTENTIOMETERS DIME SIZE



For Transistor and Sub-Miniature Circuits

Versatile carbon controls for audio, tone and similar applications; specially designed for Transistor and Sub-miniature circuits. Only 3/4" diameter, Shaft 1" long 1/8" diameter. Shaft easily cut to desired length, includes nut and lock washer. Shpg. wt. 2 oz.

WITHOUT SWITCH

VC-32 1,000 ohms VC-24 25,000 ohms } **49¢**
VC-33 5,000 ohms VC-36 50,000 ohms } each
VC-34 10,000 ohms VC-37 1/2 Meg
VC-35 15,000 ohms VC-38 1 Meg
MS-185—Miniature Knob 3/8" Diam.—Net..... 7c

WITH S.P.S.T. SWITCH

These Versatile Sub-Miniature Controls with S.P.S.T. switch ratings 1 amp at 20 Volts, 1/4 amp at 67 1/2 volts. Control was especially designed for Transistor and Sub-Miniature applications; Bushing 1/4" diameter and 1/4" long, includes nut and lock washer. Only 3/4" diameter 33/64" deep, shaft 1" diameter, 1" long. Shaft can be cut to desired length.

VC-26 1,000 ohms VC-25 25,000 ohms } **69¢**
VC-27 5,000 ohms VC-31 50,000 ohms } each
VC-28 10,000 ohms VC-39 1/2 Meg
VC-29 15,000 ohms VC-40 1 Meg
MS-186—Miniature Knob 3/8" Diam.—Net..... 7c

MINIATURE KNOB



Plastic knob, only 5/8" diameter fits 1/8" shafts, for miniature components such as Ferris-loopstick, sub-miniature pots, etc.

MS-185 Net 7¢



MILLER TRANSISTOR I.F. TRANSFORMERS

These transformers have been designed for use with the Raytheon Transistor type CK760. They feature a tapped primary having an impedance near 25,000 ohms, and a secondary winding having an impedance near 600 ohms. 455 kc. Pri. 25 K Sec. 600. Size: 1/2" sq. x 3/4" high.

No. 2041 Net 1.62

MILLER TRANSISTOR LOOP ANTENNA



A fixed inductance loop with a large pickup field to insure adequate signal to the first stage. Inductor is tapped to match an input impedance of 600 ohms. Frequency range 540-1650 kc when used with a variable capacitor having a maximum capacity of 365 mmfd. Size: 1 1/4" x 9/16".
No. 2000 Loop Antenna Net 1.62

MILLER TRANSISTOR OSCILLATOR COIL



For use with a transistor to supply the local oscillator energy to the mixer stage. Used with a variable capacitor having a maximum capacity of 365 mmfd. Intermediate frequency 455 kc. Broadcast band 540-1650 kc. Padder .0004 mmfd. Mounting clip fits into a 5/16" diameter hole. Size: 3/8" x 1 1/8" high.
No. 2020 Net 1.18

39¢ MINIATURE VOLUME CONTROL

3/4" DIAMETER

Only 3/4" Diameter, overall depth approximately .4" including threaded shaft. Ideal for miniature radio, hearing aids, etc.

VC-18—Range 0-500,000 audio taper.. 39¢
VC-19—Range 0 to 1 Meg. linear taper 39¢
VC-20—Range 0 to 3 Meg. audio taper 39¢
In Lots of 10—\$3.25



35¢

4 POSITION MINIATURE SWITCH 3/4" DIAMETER

Has 4 positions, one marked OFF. Less than 1/2" deep including contact prongs. Self contained wheel type knob. Ideal for miniature radio, hearing aids for tone control switch, etc.

SP-88 Net .35
10 for 3.25

AN R/C RECEIVER COMPLETELY ASSEMBLED AND WIRED — INCLUDES TUBE — READY TO OPERATE!

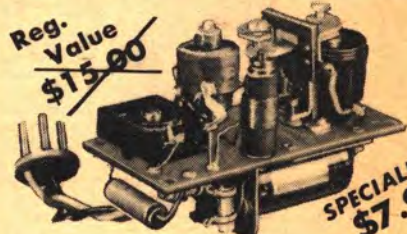

Reg. Value ~~\$15.00~~

SPECIAL! \$7.95

A truly sensational value in a superbly designed and constructed hard-tube R/C receiver. Operates on popular exam-free 27.255 MC remote control band. Extremely efficient and dependable, this amazing receiver has more than adequate sensitivity for a range of approximately 1 mile. Outstanding for economy of operation, its minimum life with initial 3S4 tube is several thousand hours! Ingeniously constructed for unmatched stability of performance, and to withstand unusual vibration and shock. Requires one 1.5 volt A battery, one 45 volt B battery and 24" antenna lead. Size: 1 3/8" x 1-15/16" x 3". Weight 3.3 oz.

F-208 Net 7.95



Z-9A Socket

15¢

Ceramic low-loss socket for Peterson type Z-9A, 27.255 MC Crystal.
Net 15¢

27.255 MC REMOTE CONTROL CRYSTAL

CRYSTAL



27.255 MC crystal used in remote radio control of hobby airplanes, boats, etc. Frequency lies within "citizen band"

Low drift, high output, dependable frequency control. Tolerance .04%. 0.720" wide x 0.309" deep x 0.758" high above pins; 1/2" between pins.
MS-296 Net 2.95

MUELLER MINI-GATOR CLIP



Smallest made steel, cadmium plated alligator jaws open 3/16". Length 1-1/16". Solder connection. For #20 or smaller wire. Uses No. 32 Insulator.

MUELLER 30 Each 7c 10 for 45c

MINIATURE AND SUB MINIATURE SPECIALTIES

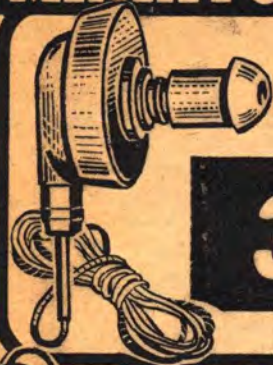

NEW!

395

SUPER POWER DYNAMIC EARPHONE FOR TRANSISTOR CIRCUITS

SPECIAL HIGH OUTPUT-FOR LOW POWER CIRCUITS

Lafayette brings you the answer to the problem of the low output inherent in transistor circuits, where the power is so low you cannot afford to lose any of it. You'll be amazed at the difference in volume when you use this new dynamic earphone. Extra efficient construction with a powerful magnet gives up to 3 times the volume of other dynamic earphones, and at the same time gives you the quality of reproduction that is possible only with a dynamic unit. We've tried it on all kinds of transistorized circuits, and this remarkably efficient earphone preserved the precious power so well that in many cases the program was plainly heard with the earphone 2 feet away from the ear. It is not, of course, limited in use to low power devices — it will give superior performance wherever a high impedance dynamic earphone is required. AC impedance 8000 ohms, DC resistance 2000 ohms. Comes complete with 3 ft. detachable plug-in cord. **MS-260**.....Net **3.95**

CRYSTAL EAR PHONE

Small, almost weightless, plastic ear phone with crystal element, that features high power and sensitivity. Ideal for all applications where a very high impedance unit is preferred. Fits comfortably in the ear. Complete with 3 ft. plastic covered cord.

CAN BE USED AS MICROPHONE

This unit is so powerful and sensitive that it can be used as a close-talking highly directional crystal microphone. Just screw off the ear-insert and your earphone becomes a mike to use for all sorts of experiments and gadgets.

MS-111.....Net **1.49**



ALL-PURPOSE DYNAMIC EARPHONE

- FOR RADIO & TV LISTENING
- FOR SUBMINIATURE, MINIATURE & TRANSISTOR RECEIVERS

A sensitive all-purpose earphone designed for your listening pleasure. Combines the range of a dynamic earphone with the performance of its special magnet to give you excellent reproduction. Lightweight and equipped with ear support that slips comfortably over your ear. You can relax! The support is practically invisible — the earphone can't slip out — it can't fall off. Ideal for use with TV and radio sets, amplifiers, miniature and transistor receivers etc. Complete with 3 ft. cord. A super value for the price!



- MS-273** — 3000 ohm impedance, 1000 ohm DC resistance, with phone tip plugs Net **1.95**
- MS-277** — 6 ohm impedance, with phone tip plugs. For silent radio and TV listening or viewing Net **1.95**
- MS-278** — 3000 ohm impedance, 1000 ohms DC resistance, with sub-miniature phone plug and matching phone jack Net **2.39**
- MS-279** — 6 ohm impedance, with subminiature phone plug and matching phone jack. For silent radio & TV listening or viewing Net **2.39**

NEW! GEM REMOTE CONTROL RELAY

3.47

- The Mighty Mite of the R/C Field
- Weighs less than 1/2 oz!
- Size: 3/4" H, 17/32" W, 1-1/16" L

A natural for remote control receivers, it is highly sensitive, and built to withstand severe crashes. The smallest commercial job available, it weighs less than 1/2 oz. Factory adjusted to pull in at 1.4 MA. drop out at 1.2 MA D.C. Single pole, double throw. Used in outstanding R/C receivers. 5,000 ohm coil.....Net **3.47**

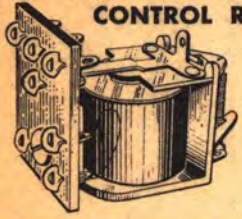

EARPHONE SUPPORT

A light, transparent plastic earphone support that fits comfortably around ear and is practically invisible. Earphone can't slip out nor fall off. Has 1/4" retaining hole for earphone. **MS-260, MS-273, MS-277, MS-278 and MS-279. MS-280**.....Net **29¢**



TELEX HEADSETS, EARSETS, SPEAKERS for Listening Comfort

TELEX MONOSET

Under-the-chin lightweight headset for individual listening. Reduces head fatigue. Removable white plastic ear plugs for easy cleaning. Magnetic type. Weighs 1.2 oz. Complete with 5 ft. cord and standard phone plug.

- MODEL 4600** — 128 ohms List **12.50** Net **7.35**
- MODEL 4625** — 2000 ohms List **12.50** Net **7.35**



TELEX CORD AND MINIATURE PLUG

5 ft. cord with 90° miniature plug. Shpg. wt., 5 oz.

- MODEL 9200** List **3.15** Net **1.85**



TELEX TWINSET

Banishes headachy ear pressure. Band rests on head and receivers set gently at temples; tubular sound arms pipe signal to ears. Only 1.6 oz. C.A.A. approved for pilots. Complete with 5 ft. cord and standard phone plug. Shpg. wt., 10 oz.

- MODEL 3791** — 64 ohms List **18.25** Net **10.73**



TELEX TELA-EAR

New miniature earphone that slips over either ear. A light, sanitary crystal-clear sound-shield transmits sound directly into the ear without touching it with a button receiver. Standard UN delegate earphone. Cannot fall or slide off. Sealed, rustproof receiver guarantees constant top performance. Complete with 5 ft. cord and standard phone plug. Shpg. wt., 8 oz.

- MODEL 8560** — 128 ohms — List **12.50** Net **7.35**
- MODEL 8561** — 2000 ohms — List **12.50** Net **7.35**



TELEX HI-FI DYNASET

Sensitive Hi-Fi under-the-chin dynamic headset. 50-8000 cycle response to 25 MW. Midget 3/4" 6-ohm speaker built right into the plug. Light gray finish. Shpg. wt., 6 oz.

- MODEL 6701** — 6 ohms — Complete List **14.75** Net **8.67**



TELEX DYNAMIC PILLOW SPEAKER

New dynamic miniature pillow speaker gives ultimate in tonal quality without distortion. For individual and institutional use. Stainless steel, moisture proof housing. Size: 3 3/4" dia., 1 1/8" max. thickness. With 5 ft. cord and standard phone plug. Shpg. wt., 8 oz.

- MODEL 8110** — 3.0 ohm List **10.20** Net **6.00**
- MODEL 8130** — 10,000 ohm List **12.10** Net **7.11**



TELEX MIDGET EARSET

The modern miniature earphone that slips on the ear. Convenient and comfortable to wear and holds receiver securely in place. 200 to 10,000 cycles frequency response. Reversible clear plastic frame fits either ear. Metal frame unit available for eyeglass wearers. Weight 1/2 oz. less cord. Complete with 5 ft. cord and standard phone plug. Shpg. wt., 7 oz.

- MODEL 4680** — 2000 ohms — Plastic
 - MODEL 4670** — 128 ohms — Plastic
 - MODEL 4643** — 2000 ohms — Metal
 - MODEL 4641** — 128 ohms — Metal
- List **11.30**, Net **6.64**



TELEX PILLOW SPEAKER

Only 2 1/4" diameter and only 3/8" thick! Ideal for comfortable radio or television listening through a pillow in bed or in a chair without disturbing others. Maroon waterproof plastic. Complete with 5 ft. cord and standard phone plug. Shpg. wt., 8 oz.

- MODEL 4500** — 128 ohms List **10.70** Net **6.29**
- MODEL 4530** — 2000 ohms List **10.70** Net **6.29**



LAFAYETTE

Leads the Field in
TRANSISTORS

**Circuits Kits
& Components**



Another
Lafayette
First!

SUBMINIATURE PHONE PLUG AND JACK



Latest and tiniest phone plug and jack available. Only 1" long x 3/4" diameter, overall. Highest quality styling and construction. Excellent for transistor and subminiature applications. Plug has removable sleeve. Jack can be mounted on panel up to 1/16" thick. Jack can be used for both open and closed circuits.

MS-281—Plug Net 22¢
MS-282—Jack Net 17¢

STANDARD PIEZO CDS-3 CADMIUM SULPHIDE PHOTOCELL



A miniature crystal photocell that is ideal for counting, activating and measuring applications. Rapid response—fast enough to operate the fastest relay. Resistance change response is proportional to light—highly linear from 1 ft. candle to 0.001 ft. candle permitting delicate measurements involving minute changes in light intensity. For light interruption applications, intensities as high as 150 ft. candles are useable. Min. current output 1.5 ma at 60 ft. candles and 90VDC with 10,000 ohm load. Dark current less than .2 ma at 90VDC. Max. dissipation 150 mw. Max. volt. 200V peak.

CDS-3 Photocell..... **3.60**

MINI-MIKE® TELEX SPEAKER-MICROPHONE



DYNAMIC SPEAKER-MICROPHONE

Truly an outstanding addition to the famous Telex line of miniature electronic equipment and parts. The new dynamic Speaker-Microphone Model 100 may be used as a speaker or a microphone and is only 1 x 1 x 3/4" in size. The advantages of miniaturization are amazingly combined with sensitivity and high quality dynamic performance.

Perfect for use in dictating machines, portable radio transceivers and other electronic equipment requiring super-small size transmitting-receiving units. The Mini-Mike has available a miniature external transformer for matching the microphone to grid circuits. Rugged construction throughout assures long-lasting dependability.

Sensitivity—microphone with transformer: 52 db blow 1 volt per dyne per sq. cm.; speaker: 124 db with 10 milli-watts of power input. Impedance—10 ohms. Construction—Weight 1 1/2 oz.; Size 1 x 1 x 3/4". Tough thermo-setting plastic and steel case.

Complete Unit—Part No. 9155—10 ohms **Net 4.65**
A miniature external transformer miniature—Size 1 1/16" x 5 1/16" x 1/2"—is available at extra cost for matching Speaker-Microphone Model 100 to grid circuits. No. 8918 Net 2.28

SUN BATTERY



International Rectifier's Sun Battery requires no external voltage source for operation. Average sun-light will generate a 2 ma current under a 10 ohm load. Can be connected directly to a milliammeter and used as a light measuring device. Can be used in series or series-parallel as power supply for transistorized equipment. Typical applications are—direct conversion of light to electricity—spectrophotometers—light measurement—traffic control—headlight dimmer—burglar alarms—timers—colorimeters—garage door opener—light beam communication. Specifications: 72"x443"x.040" 60 micro amps at 100 ft. candles with 55 ohm load. .5 volt in average sun-light. .25 volts at 100 ft. candles. Complete with 3/4" mtg. bracket and 6" leads.

MS-112..... Net 1.47

NEW! CLAIREX CRYSTAL PHOTOCELL TYPE CL-2



The latest version of this famous cadmium sulphide crystal features greater stability, greater sensitivity to low voltages, lower noise level at low life. Highly pure cadmium sulphide crystal extremely sensitive to light over the entire visible spectrum, with maximum response near green portion, exceptionally good sensitivity to red, and X rays and gamma rays. High output voltage and relatively high output current. Will operate a meter, a relay, a neon lamp, cold cathode gas triode, to full output at low frequencies. Ideal for constructing exposure meter, for linear with voltage. At 100V and 2 ft. ua. at 1V it is 100 ua, at 10V it is 10 ua. at 100 volts. Requires voltage or DC. Size 3/4" x 1/2" long.

CLAIREX-CL-2 Net 3.50

FLEA CLIPS FOR TRANSISTOR AND SUBMINIATURE CONTACTS



"Flea" clips are specially designed for subminiature work. Fit perfectly in holes in MS-262 board. Made of beryllium copper, silver plated finish. Simply insert wire thru hole for positive grip contact.

MS-263 Package of 12 Net 25¢

NEW!

TINY PLUG AND JACK



Lafayette is first to bring you this miniature plug and jack combination. Ideal as input and output terminations in transistor and subminiature receivers, hearing aids, etc. Extremely small convenient phenolic plug 13/32" dia. x 27/32" long, overall. Matching flat bakelite socket 3/4" long holes. A super value combination.

MS-283—Plug Net 12¢
MS-284—Jack Net 10¢
MS-285, 2 plug jack—1 1/4" long, 3/8" wide Net 12¢

SELENIUM PHOTOCELL 11.03



Barrier layer, self-generating type; light striking upon cell generates current sufficient to operate a relay directly without the use of auxiliary power. Lifetime of cell is unlimited. 600 microamperes of output at 100 foot candles. 2 inches in diameter. Mounted in a handsome plastic case.

MS-152—Photocell—Wt. 8 oz. ... 11.03

PERFORATED BAKELITE BOARD FOR TRANSISTOR AND SUBMINIATURE CIRCUITRY



Ideal base for mounting transistors and subminiature parts for builders and experimenters. Sturdy high grade bakelite 3-7/16" x 2 3/4" x 1/16" thick, with 1/8" clearance between holes. For contacts see MS-263 clips below.

MS-262 Net 19

NATIONAL FABRICATED LIFETIME SILICON SOLAR CELL



The first device to convert useful amounts of the sun's energy directly and efficiently into electricity. Conversion efficiency remains essentially constant even in poor light. Measures up to 0.5 volt on open circuit under direct noon sunlight, and converts solar energy to electrical power at a rate up to 10 mw. Permanent life-time p-n junction. Will operate on infra-red light. Only 1 3/4" dia. x 3/16" thick. Shpg. wt., 4 oz.

Type S-1 Net 20.00

TELEX MINIATURE PHONE PLUG AND JACK

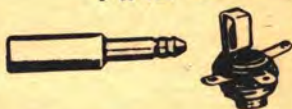

1/3 the size of previous small plugs and jacks, yet with all the quality of precision workmanship. Plug is 1-7/32" long by 1/4" diameter. Jack can be mounted on any panel up to 1/8" thick.

TELEX NO. 9231—PLUG35
TELEX NO. 8570—JACK (Closed Circuit).....24
TELEX NO. 9240—JACK (Open Circuit).....24

SHURE 1 INCH MIKE



Specially designed for miniature "build it yourself" equipment, transistor type devices, hearing aids, etc. Controlled reluctance type. Output level—71 db. Impedance type. Output level—75 db. Resistant to heat, humidity; shock proof. Muv metal shield. 1" diameter.

SHURE MC-11 Net 7.35

NEW!... SHURE 1 INCH RECTANGULAR MIKE



Experimenters' delight! 1" rectangular controlled reluctance microphone. Ideal for transistor hearing aids, amplifiers, etc. 1100 ohms impedance; output level—75 db. Resistant to heat, humidity; shock proof.

SHURE MC-20 Net 7.35

TRANSISTOR SINE-WAVE GENERATOR KIT



Reliable, compact transistorized test instrument! The pocket-sized audio signal generator! This generator can be a valuable test instrument in the hands of the experimenter or technician. With it he can service and check operation of P.A. systems, phonograph amplifiers, intercom systems and the audio section of auto sets, home radios and portables, size 3 1/4" x 2 1/8" x 1 5/8". Shpg. wt., 3 lbs. Kit comes complete with two transistors, metal cabinet, condensers, resistors, transformer etc. schematic diagram.

KT-83 Net 8.75

8.75

PLASTIC CASES FOR MINIATURE ELECTRONIC GEAR

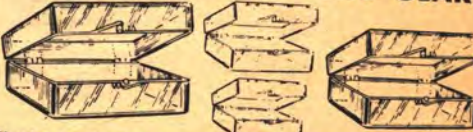

They're here! The miniature cases you've been clamoring for! Perfect for transistor, sub-miniature and miniature amplifier, pre-amplifier, receiver, transmitter, oscillator and miniature amplifier, etc. housing. Sturdy polystyrene case without partitions, circuit, ball-type hinge that permits removal of cover. Crystal clear to facilitate inspection and servicing. *Removable covers without hinge. *Hinged cover not removable.

STOCK NO.	SIZE L x W x H	NET	STOCK NO.	SIZE L x W x H	NET
MS-156	1 5/8 x 2 1/8 x 1"	.09	MS-161†	4 5/8 x 2 3/4 x 1"	.30
MS-157	2 1/8 x 1-3/16 x 1"	.12	MS-162†	4-15/16 x 3-9/16 x 1 1/4"	.32
MS-158	2 7/8 x 2 x 1"	.15	MS-163*	5 x 5 1/4 x 1-5/16"	.35
MS-159	3 5/8 x 2 5/8 x 1"	.18	MS-164*	5 3/4 x 3 x 1-3/16"	.22
MS-160*	4 5/8 x 2 1/4 x 3/4"	.20			

10 IN 1 TRANSISTOR SOCKET STRIP



A single 10 socket bakelite strip that can accommodate ten transistors. Excellent for saving space in layouts where more than one transistor is used. Can be sawed into any number of required sockets up to 10. Printed circuit eyelet contact terminations. Easy to mount with multiple mounting holes provided. Size: with multiple mounting holes provided. Size: 7 1/2" long, 15/16" wide, 1/4" thick.

MS-286 Net 6.68

BATTERIES TRANSISTOR, HEARING AD, PORTABLE, SUN

NEW! RCA TRANSISTOR BATTERIES



New RCA miniature batteries specially designed and constructed for Transistor and subminiature applications. Unusually high operating and shelf life. Rugged and dependable. All have 2-Snap Fasteners except VS400 has flashlight terminals and VS301 has 4-hole socket.

Type	Volts	Size Diam. x L. (in.)	SHPG. WT.	NET EACH
VS311	4.0	1/2 x 1	1 Oz.	.57
VS308	4.0	15/16 x 1-1/8	3 Oz.	.67
VS400	4.0	1-1/32 x 1-31/32	6 Oz.	1.72
VS310	6.0	1/2 x 1-1/4	1 Oz.	.70
VS307	6.0	15/16 x 1-1/4	3 Oz.	.77
VS300	9.0	31/32 x 1-31/32	5 Oz.	.94
VS309	9.0	1/2 x 1-7/8	2 Oz.	.84
VS301	3.6-9	8L x 1-9/16W x 2-13/16H	3 lb.	1.05

TRANSISTOR BATTERY HOLDERS



These Battery Holders were especially designed for use in transistor and sub-miniature electronic gear, are made of Aluminum Alloy, sturdy construction with insulated, nickel plated Brass eyelets for easy soldering.

STOCK NO.	DESCRIPTION	NET
MS-137	For 1 #7 Cell	.18
MS-138	For 2 #7 Cells	.37
MS-169	For 3 #7 Cells	.44
MS-170	For 4 #7 Cells	.57
MS-139	For 1 #Z Cells	.20
MS-140	For 2 #Z Cells	.37
MS-171	For 3 #Z Cells	.44
MS-172	For 4 #Z Cells	.57
MS-173	For 1 #1 Cell	.20
MS-174	For 2 #1 Cells	.37
MS-175	For 1 #2 Cell	.20
MS-176	For 2 #2 Cells	.37
MS-177	For U15 22 1/2 V Cell	.20
MS-178	For 2 U15 22 1/2 V Cells	.37
MS-179	For 2 Mallory RM-5020	.26
MS-180	For 4 Mallory RM-5020	.39
MS-181	For 2 Mallory RM12R	.26
MS-182	For 4 Mallory RM12R	.39
MS-183	For 1 #413 30 volt Cell	.24
MS-184	For 2 #413 30 volt Cells	.39
MS-225	For #Y-10 cell	.25

BURGESS TRANSISTOR AND HEARING AID BATTERIES



BURGESS REPLACES	VOLTS	SIZE L x W x H (in.)	SHPG. WT.	NET EACH
N	VS073	1 1/2	1-11/64 x 7/16 diam.	1 oz. .08
4D4	ER274	6	2-17/32 x 2 x 7-5/16	3 lb. 2.69
2M6	ER246	9	1 3/8 x 1 3/8 x 2 3/4	1 lb. 1.19
ER276	9	1-9/32 x 29/32 x 2-7/32	1 1/2 lbs. 1.16	
2U6	ER216	9	1 x 39/64 x 1 1/8	3 oz. 1.06
XX9	ER239	9, 13 1/2	1-9/32 x 29/32 x 2-7/32	4 oz. .85
K10	VS083	15	1 3/4 x 7/8 x 1-17/32	4 oz. 1.05
Y10	ER504E	15	1 x 39/64 x 1-7/16	2 oz. .77
K15	VS084	22 1/2	1 3/4 x 7/8 x 2-9/32	4 oz. 1.16
Y15	ER505E	22 1/2	1 x 39/64 x 1-31/32	2 oz. .98
K20	VS085	30	19/32 x 19/32 x 1-31/32	2 oz. .98
Y20	ER506E	30	1 3/4 x 39/64 x 2-17/32	6 oz. 1.37
Y20S	ER507E	30	1-3/16 x 19/32 x 1-13/32	2 oz. 1.23
	VS087	40	19/32 x 19/32 x 2-9/16	2 oz. 1.52
	VS088	21	3/8 x 17/32 diam.	3 oz. 1.25
	VS089	21	3-7/16 x 15/16 diam.	6 oz. 2.06

MALLORY MERCURY TRANSISTOR POWER-PAKS



TYPE	VOLTS	CAP. MAH.	H. x SIZE (in.)	MAX DRAIN MA	STD. PKG.	SIN. GLY.	NET EACH	STD. PKG.
TR-140R	1.3	1600	.980 x .505 x 1.227	200	2	1.23	1.12	
TR-152R	2.5	400	1.125 x .480	40	2	.77	.70	
TR-162R	2.5	500	.875 x .655	60	2	1.19	1.08	
TR-120R	2.5	800	.850 x .605 x 1.227	100	2	.88	.80	
TR-132R	2.5	1000	1.305 x .655	100	2	.99	.90	
TR-113R	4.0	250	.844 x .650	20	2	1.16	1.05	
TR-153R	4.0	400	1.687 x .480	40	2	.99	.90	
TR-163R	4.0	500	1.350 x .655	60	2	1.23	1.12	
TR-133R	4.0	1000	1.960 x .655	100	2	1.48	1.37	
TR-233R	4.0	2200	1.969 x 1.015	60	1	1.68	1.68	
TR-114R	5.0	250	1.060 x .650	20	2	1.29	1.17	
TR-164R	5.0	500	1.780 x .655	50	2	1.45	1.32	
TR-136R	5.0	1000	2.605 x .655	100	2	1.63	1.48	
TR-115R	6.5	250	1.295 x .650	20	1	1.40	1.40	
TR-165R	6.5	500	2.185 x .655	50	2	1.76	1.60	
TR-135R	6.5	1000	3.218 x .655	100	2	1.98	1.80	
TR-146R	8.0	1000	3.006 x .655	100	2	2.48	2.25	
TR-147R	8.0	1000	1 x .531 x 1.938	40	2	1.85	1.68	
TR-145R	7.5	350	1.185 x .640	20	2	1.49	1.35	

MALLORY MERCURY "A" and "B" BATTERIES

New standard size Mercury "A" and "B" Batteries for hearing aids, miniature radios and experimenters. Provide 2 to 3 times the service and shelf-life of ordinary types at lower operating costs. Unaffected by high temperatures. All have button contacts except "A" have tabs. Average shpg. wt. 2 1/2 oz.

"A" BATTERIES									
TYPE	VOLTS	CAP. MAH.	SIZE DIAM. H x F (in.)	MAX DRAIN MA	STD. PKG.	SIN. GLY.	NET EACH	STD. PKG.	
RM-1R	1.345	1,000	.620 x .650	100	4	.39	.35		
RM-3R	1.345	2,200	.980 x .650	60	4	.52	.47		
RM-4R	1.345	3,400	1.190 x .650	80	4	.72	.65		
RM-4RT*	1.345	3,400	1.190 x .650	80	4	.77	.70		
RM-4ZR	1.345	2,400	1.190 x .650	80	4	.58	.50		
RM-12R	1.345	3,600	.620 x 1.950	250	2	.83	.75		
RM-42R	1.345	14,000	1.190 x 2.375	1000	1	1.70	1.70		
RM-42RT*	1.345	14,000	1.190 x 2.375	1000	1	1.75	1.75		
RM-400R	1.345	80	.450 x .125	10	5	.29	.26		
RM-401R	1.345	800	.455 x 1.130	100	2	.39	.35		
RM-450R	1.345	400	.450 x .560	40	4	.31	.28		
RM-502R	1.345	2,400	.530 x 1.950	200	2	.64	.58		
RM-601R	1.345	1,800	.620 x 1.125	150	2	.56	.51		
RM-625R	1.345	250	.610 x .233	20	4	.30	.27		
RM-625RT*	1.345	250	.610 x .233	20	4	.32	.28		
RM-630R	1.345	350	.610 x .233	20	4	.31	.28		
RM-640R	1.345	500	.620 x .430	50	4	.33	.30		

"B" BATTERIES									
TYPE	VOLTS	SIZE L x W x H (in.)	MAX DRAIN MA	STD. PKG.	SIN. GLY.	NET EACH	STD. PKG.		
RM-411R	15	130	1 x 17/32	10	1	.95	.95		
RM-412R	22.5	130	1 x 17/32	10	1	1.25	1.25		
RM-413R	30	130	1 x 17/32	10	1	1.43	1.43		
RM-415R	45	130	1 x 17/32 x 3/2	10	1	2.20	2.20		

INTERNATIONAL SELENIUM SUN BATTERIES

CONVERT NATURAL OR ARTIFICIAL LIGHT TO ELECTRICAL POWER ECONOMICALLY!

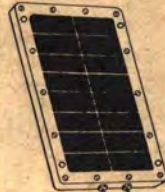

The International Sun Battery supplies electrical power to a load when exposed to sunlight or artificial light sources, and is specially processed for high illumination level and high current density operation. Mounted on bracket with 6" color coded pigtail leads attached. Impregnated for protection against humidity and atmospheric contaminants. The SB sun batteries are sealed in a phenolic case with plastic window, and mount by four holes in the frame.



TYPE	OVERALL DIMENSIONS INCH BY INCH	TYPICAL OUTPUT POWER FOR OPTIMUM MATCH TO LOAD					
		2000 foot candles		5000 foot candles		10,000 foot candles	
		Volts	MA	Volts	MA	Volts	MA
1B2PLB	0.72x0.44	0.24	1.0	0.25	2.0	0.26	3.5
1B5PLB	1.44x0.64	0.24	3.0	0.25	6.0	0.26	10.0
1B10PLB	1.69x0.88	0.24	5.0	0.25	10.0	0.26	17.0
1B15PLB	1.69x1.69	0.24	9.0	0.25	18.0	0.26	30.0
1B20PLB	2.0 x 2.0	0.24	12.0	0.25	23.0	0.26	37.0
1B30PLB	3.25x3.25	0.24	32.0	0.25	60.0	0.26	100
5B-16B10	4.8 x 8.1	4.0	5.0	4.0	10.0	4.0	18.0
5B-8B15	4.8 x 8.1	2.0	9.0	2.0	18.0	2.0	30.0

RCA and BURGESS PORTABLE BATTERIES

When ordering "A" & "B" combination packs, deduct 5% in lots of 3, assorted

BURGESS TYPE	RCA TYPE	VOLTS	SIZE L x W x H (in.)	SHPG. WT. LBS.	NET EACH
2TXK40	VS064	1 1/2, 6.0	2-13/32x1-11/32x7-5/32	2	3.38
4TZ60	VS054	1 1/2, 9.0	7-5/8x2-1/8x3-3/4	4 3/4	3.85
6TAR0	VS022	1 1/2, 9.0	9-31/32x2-1/4x4-7/16	4	4.36
17GD60	VS022	1 1/2, 9.0	15-1/16x4-3/8x7-1/16	2 1/2	6.71
TSZ50	VS050	6, 7 1/2, 7.5	8-1/2x3-11/32x2-3/8	4 1/2	4.17
TSZ50P	VS060	7 1/2, 7.5	8-1/2x3-11/32x2-3/8	4 1/2	4.17
FGA60	VS019	7 1/2, 9.0	9-5/16x2-21/32x4-5/16	7	4.80
CGM60	VS018	7 1/2, 9.0	9-7/16x3-1/8x4-1/32	4 1/2	4.80
76Z60	VS057W	7 1/2, 9.0	8-15/16x2-3/4x4-11/32	5 1/2	5.25
FGA60P	VS058	9.0	9-7/16x2-3/4x4-11/32	7	4.55
CG860	VS047	9.0	18-29/32x2-13/16x4-21/32	8	5.08
76Z60P	VS059	9.0	8-15/16x2-3/4x4-11/32	5 1/2	4.55



PORTABLE "A" BATTERIES					
		VOLTS	SIZE L x W x H (in.)	SHPG. WT. LBS.	NET EACH
1	VS035	1 1/2	1-15/16x3/8x3/4 diam.	4 oz.	.10
2D	VS069	1 1/2	2-9/16x1-9/32x2-31/32	9/16	.53
2F	VS141	1 1/2	2-19/32x1-3/8x4-1/4	1 1/4	.52
2	VS036	1 1/2	2-25/64x1-21/64 diam.	6 oz.	.10
4F	VS004	1 1/2	2-5/8x2-5/8x4-3/32	2	.88
8R	VS070	1 1/2	3-1/5/16x1-3/32 diam.	3 oz.	.35
21R	VS236	1 1/2	4-1/8x1-21/64 diam.	3 oz.	.25
37	VS034	1 1/2	6-1/8x1-5/16 diam.	1	.57
D3	VS072	1 1/2	1-31/32x3/8x5/16 diam.	4 oz.	.08
F3	VS067	4 1/2	3-7/8x1-5/8x2-1/16	1 1/4	1.70
G3	VS002	4 1/2	4-1/16x1-7/8x4-11/16	2	.74
74P1	VS009	6	2-1/32x2-21/32x4-1/8	2 1/2	.88
VS068	6	1-3/16x1-3/16x2-7/32	2 1/2	.88	
B5	VS129	3 1/2	3-29/32x7/8x2-27/32	1 1/4	.88
CS	VS065	7 1/2	2-7/32x1-15/16x3-1/32	1 1/4	.88
TS		7 1/2	2-17/32x2-19/32x3-29/32	2	.96

PORTABLE "B" BATTERIES					
BURGESS TYPE	RCA TYPE	VOLTS	SIZE L x W x H (in.)	SHPG. WT. LBS.	NET EACH
U15	VS014	22 1/2	1x39/64x1-31/32	4 oz.	.98
A30	VS036	1 1/2	3-9/16x2-1/4x4-5/16	2 1/2	1.75
B30	VS012	45	4-1/16x2-17/32x5-5/16	3 3/4	2.70
M30	VS013	45	3-9/16x1-3/4x5-1/2	3	2.07
U30	VS086	45	1-3/32x19/32x3-17/32	1/4	1.75
XX30	VS055	45	2-17/32x31/32x3-21/32	1 1/4	1.58
Z30	VS015	45	3x2-5/16x4-1/16	2	2.77
K45	VS082	67 1/2	2-11/16x1-5/16x2-1/4	1	

NEW!
Revolutionary
Design

2-GANG
SUPER-HET
Variable
Condenser

Argonne
"POLY-VARI-CON"

THE SMALLEST VARIABLE CONDENSER IN THE WORLD

$5\frac{5}{8}'' \times 1\frac{1}{16}'' \times 1\frac{1}{16}''$



365 MMF SINGLE GANG
SUPER-MIDGET
VARIABLE CONDENSER

The newest and one of the finest single gang variable condensers on the market. Designed to give exceptional performance in TRF and experimental circuitry. 10 to 365 mmf single gang. Tunes through 180°. Completely enclosed in plastic case. $5\frac{5}{8}'' \times 1\frac{1}{16}'' \times 1\frac{1}{16}''$.

MS-274 Net 1.25



1.95

Lafayette does it again with this new super 2 gang midget variable condenser. An exciting and proven innovation in the transistor parts field! Manufactured for top performance in transistor super-het circuits, it measures only $5\frac{5}{8}'' \times 1\frac{1}{16}'' \times 1\frac{1}{16}''$. Has 2 gangs specifically designed for transistor super-hets — 10 to 208 mmf capacitance on the antenna section, and 10 to 100 mmf on the cut oscillator section. Self contained trimmers. Tunes through 180°. Entirely enclosed in a transparent plastic case! The smallest complete 2 gang variable for super-hets in the world! Offers unlimited possibilities to the experimenter.

MS-270 Net 1.95

TRANSISTOR SUPER-HET
LOOP ANTENNA



The latest transistor loop antenna especially designed to match the input impedance of the RF stage in transistor super-het circuits. Requires maximum capacity of 208 mmf in RF section of variable condenser. Matched with the New Super Midget 2 gang variable condenser, MS-270 to give excellent sensitivity and selectivity through the entire broadcast band of 540-1650 kc. Wound on high efficiency iron core $3\frac{1}{2}''$ dia. x $\frac{1}{4}''$ dia.

MS-272—Ant. Coil Each, Net .95

TRANSISTOR
OSCILLATOR
COIL



For 455KC IF circuits. Matches MS-270 variable condenser when used with MS272 ant. loop; matches MS-261 variable cond. with MS264 ant. loop. Size $\frac{3}{8}'' \times 1''$.

MS-265.....In lots of 6, Ea. 69¢
 Singly, Each 79¢

MATCHED TRANSISTOR 455 KC I.F.'S

*FERRITE CORE—SLUG TUNED *ONLY $\frac{1}{2}''$ SQ. x $\frac{3}{4}''$ H

Products of the latest engineering research, these 455 KC transistor I.F. transformers are designed with improved ratios of primary to secondary turns and of capacity to inductance for perfect impedance matching. Exacting research has proven that matching 1st and 2nd I.F.'s having a primary impedance of 25,000 ohms and a secondary impedance of 600 ohms with a 3rd I.F. having a primary impedance of 25,000 ohms and a secondary impedance of 1,000 ohms gives vastly improved results in transistor superhet circuits. Lafayette is first to make these specially matched transistor 455 KC I.F. transformers available to you!

MS-268 1st and 2nd I.F. primary impedance 25,000 ohms, secondary 600 ohms .89
 MS-269 3rd I.F. primary impedance 25,000 ohms, secondary 1,000 ohms .89



VARIABLE CONDENSERS

MIDGET 2 GANG SUPER

2 gang. Front section 27 plates with capacity of 10.5 mmf to 365 mmf; rear section plates with capacity of 7.6 mmf to 132 m15 Individual trimmers on each section. End plates of RF section slotted for easy tracking. 180° rotation. Capacity increases counter clockwise. $\frac{3}{4}''$ diam. brass shaft, mounted on ball-bearings, extends $1\frac{1}{2}''$ from cadmium plated steel frame. Frame size: $1\frac{1}{16}''$ D x $1\frac{1}{2}''$ W x $1\frac{5}{16}''$ H. Standard mounting holes front and rear. Brass contact wiper. For superhet circuits with 455 KC IF. Shpg. wt., 10 oz.

MS-141 Net 98¢

2 GANG TRF

Same construction as above but each gang has 23 plates. Maximum capacity each section 365.7 mmf, minimum 10.3 mmf. Frame size $2\text{-}3\frac{1}{16}''$ D x $1\text{-}13\frac{1}{16}''$ W x $1\frac{3}{4}''$ H. Shpg. wt., 10 oz.

MS-142 Net 98¢

MIDGET 1 GANG TRF

Similar in construction to above but single gang with capacity from 10 to 365 mmf. Size $1\text{-}3\frac{1}{16}''$ D x $1\text{-}5\frac{1}{16}''$ H x $1\frac{3}{8}''$ W.

MS-214 Net 73¢

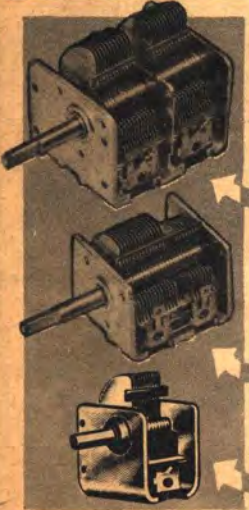

TRANSISTOR MINIATURE 2 GANG
SUPER-HET VARIABLE CONDENSER

ONLY $15\frac{1}{16}'' \times 1\frac{3}{8}'' \times 1\text{-}5\frac{1}{16}''$

All the new miniaturized transistor operated sets such as GE, Regency, etc., are using this truly miniature 2 gang variable. Lightweight — both the frame and plates are aluminum. Smooth ball bearing action over entire 180° rotation. Bakelite stator insulation. Capacity of 11 plate R.F. section is 6.3 to 123.1 mmfd; 9 plate oscillator section is 5.7 to 78.2 mmf. Effective range of trimmers 15 mmf. These add 2 mmf to minimum capacity. Capacity increases in counter clockwise direction. Flatted shaft, $\frac{1}{4}''$ diameter by $1\frac{1}{2}''$ long.

Frame size only $15\frac{1}{16}''$ D x $1\frac{3}{8}''$ W x $1\text{-}5\frac{1}{16}''$ H. Shpg. wt. 5 oz.

MS-261 Net .95

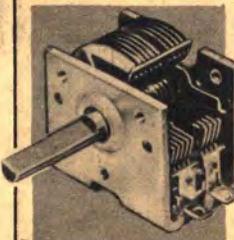

TRANSISTOR LOOP ANTENNA AND OSC. COIL



MS-264

A loop antenna with a primary inductance of 700 microhenry, especially designed with the proper tap to match the input impedance required in transistor circuits. Covers the entire broadcast band from 540-1650 KC when used with latest miniature type variable condensers such as used in G.E. Regency and other sub-miniature sets. (Lafayette MS-261 is ideal). Requires maximum capacity of 123 mmf in RF section of variable condenser. Wound on high efficiency iron core $4''$ long x $\frac{1}{4}''$ diam.

MS-264 Net .95 in lots of 6, Each .89

MS-265 Matching Oscillator Coil. In lots of 6, Each 69¢ Singly, Each 79¢



MS-265

69¢

MINIATURE 365 mmf
VARIABLE COND.

* ONLY $\frac{3}{16}''$ Thick

A new type of variable condenser that is ideal for the builder of transistorized and miniature equipment. Capacity variable from 10 to 365 mmf. Single gang, measures only $\frac{3}{16}''$ thick x $1\frac{1}{2}''$ square. Bushing and shaft extend $\frac{7}{8}''$. 180° rotation.

MS-215 Net 69¢



MATCHED SET

TRANSISTOR ANTENNA LOOP AND OSC. COIL
FOR USE WITH 365 MMF CONDS. SUCH AS MS142

A Transistor Loop Antenna with a fixed inductance loop; specially designed with $\frac{1}{2}''$ diameter Ferrite Rod to insure adequate signal to the first stage. Inductor is tapped to match an input impedance of 600 ohms. Frequency range 540-1650 Kc. when used with variable condenser having a maximum capacity of 365 mmfd. Dimensions $9\frac{1}{16}'' \times 4\frac{1}{8}''$.

MS-166 NET 1.25

OSCILLATOR COIL

Designed for transistor circuits to supply the local oscillator energy to mixer stage. Intermediate frequency 455 Kc. Used with a variable condenser maximum capacity of 365 mmfd. Mounting clip fits into $\frac{3}{8}''$ diameter hole. Dimensions $\frac{5}{8}'' \times 1\frac{1}{8}''$ high.

MS-165 Net 69¢





**100%
SUBMINIATURIZED**

6 TRANSISTOR SUPER HET CIRCUIT

WITH CLASS "B" PUSH PULL AMPLIFICATION



BUILD A 6 TRANSISTOR SUPER HET RECEIVER

- 100% SUBMINIATURE PARTS—NO COMPROMISES!
- LABORATORY DESIGNED—SENSITIVE, SELECTIVE, STABLE!
- CLASS B PUSH-PULL AMPLIFICATION—PLENTY OF POWER!

This circuit has been especially developed for the experimenter and engineer who wants a set of really-commercial quality. To make it possible, Lafayette has made available all the heretofore impossible to find subminiature electronic parts. The circuit uses 3 RF Transistors, 3 Audio Transistors, a crystal diode and features specially matched set of 3 I.F.'s, Oscillator, High Q Loop, Class B P.P. Audio Amplification, Transformer Coupling in Audio and output stages. Special care has been taken in the design for exact impedance matching throughout to assure maximum transfer of power. We supply all the basic electronic components, leaving chassis and cabinet and physical layout to your ingenuity.

COMPLETE LIST OF PARTS — LESS CHASSIS AND CASE ALL PARTS MAY BE PURCHASED INDIVIDUALLY

QUANT.	STOCK NO.	DESCRIPTION	NET EA.	TOTAL	QUANT.	STOCK NO.	DESCRIPTION	NET EA.	TOTAL
1	MS-270*	Variable Condenser	1.95	1.95	1	CF-122	10 mfd 15V Cond. ELECT.	.33	.33
2	MS-268	1st & 2nd I.F.	.89	1.78	1	CF-126	100 mfd 15V Cond. "	.45	.45
1	MS-269	3rd I.F.	.89	.89	1	CF-120	2 mfd 15V Cond. "	.29	.29
1	MS-265	Oscillator Coil	.79	.79	1	CF-103	10 mfd 6V Cond. "	.29	.29
1	MS-272*	Antenna Coil	.95	.95	1	X-1060	.05 mfd Paper Cond.	.29	.29
2	2N135*	G.E. Transistor	2.70	5.40	1	MS-173	Battery Holder	.20	.20
1	2N-136*	G.E. Transistor	3.10	3.10	1	VS-300	9 Volt Battery	.94	.94
3	2N107	G.E. Transistor	1.25	3.75	3	CJ-55A	5 Lug Terminal Strips	.06	.18
1	1N64	G.E. Diode	.50	.50	1	5206A	12 Ohm 1/2 Watt Res.	.05	.05
6	MS-275	Transistor Sockets	.19	1.14	1	5206A	68 Ohm 1/2 Watt Res.	.05	.05
1	AR-109	Driver Transformer	2.95	2.95	1	5206A	330 Ohm 1/2 Watt Res.	.05	.05
1	AR-120	Output Transformers, 10-12 Ohm Sec.	2.95	2.95	2	5206A	1000 Ohm 1/2 Watt Res.	.05	.10
1	SK-39	RCA 2 3/4" Speaker, 12 Ohm Voice Coil	1.79	1.79	2	5206A	2200 Ohm 1/2 Watt Res.	.05	.10
1	VC-27	Min. Pot with Switch	.69	.69	1	5206A	3300 Ohm 1/2 Watt Res.	.05	.05
1	MS-186	Min. Knob for V.C.	.07	.07	2	5206A	4700 Ohm 1/2 Watt Res.	.05	.10
7	C-601	.01 Ceramic Disc	.09	.63	2	5206A	6800 Ohm 1/2 Watt Res.	.05	.10
2	C-601	.005 Ceramic Disc.	.09	.18	1	5206A	27,000 Ohm 1/2 Watt Res.	.05	.05
2	C-601	5 mmf Ceramic Disc.	.09	.18	2	5206A	33,000 Ohm 1/2 Watt Res.	.05	.10
					1	5206A	47,000 Ohm 1/2 Watt Res.	.05	.05
					2	5206A	100,000 Ohm 1/2 Watt Res.	.05	.10

Complete List of Parts as listed above for 6 Transistor Super Het Circuit.
CI-100

Net **33.56**

***Alternate Components**

MS-261 Variable Condenser (.95) and Matching Loop Antenna MS-264 (.95).
If you desire to use a speaker with 3.2 ohm voice coil, use AR-119 output transformer instead of AR-120

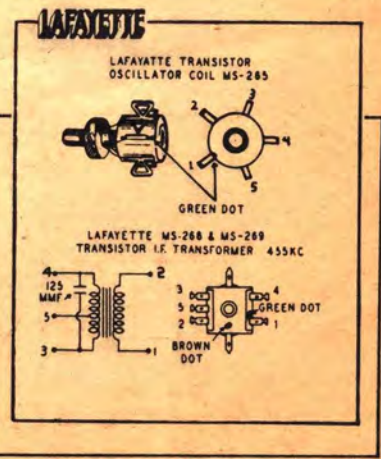
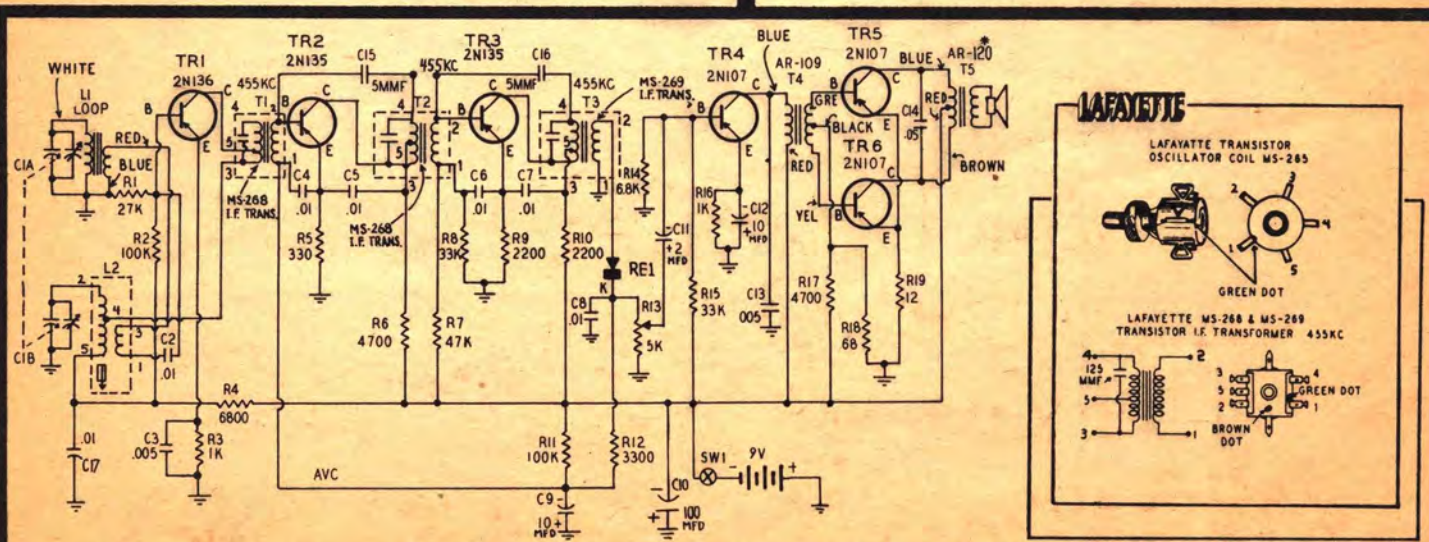

* AR-120 TRANSFORMER MATCHES 10-12 OHM VOICE COIL SPEAKERS SUCH AS RCA SPEAKER 2 3/4" SK-39
AR-119 MATCHES 3.2 OHM VOICE COIL SPEAKERS



100%
SUBMINIATURIZED

4 TRANSISTOR SUPER HET CIRCUIT



POCKET SIZE 1 3/8" x 2 1/2" x 3 1/2" — BUILT-IN ANTENNA! REQUIRES NO
EXTERNAL ANTENNA OR GROUND! FEATURES THE NEW ULTRA-MINIATURE
POLY-VARI-CON! 2 I.F. STAGES AND 2 RC COUPLED AUDIO STAGES!

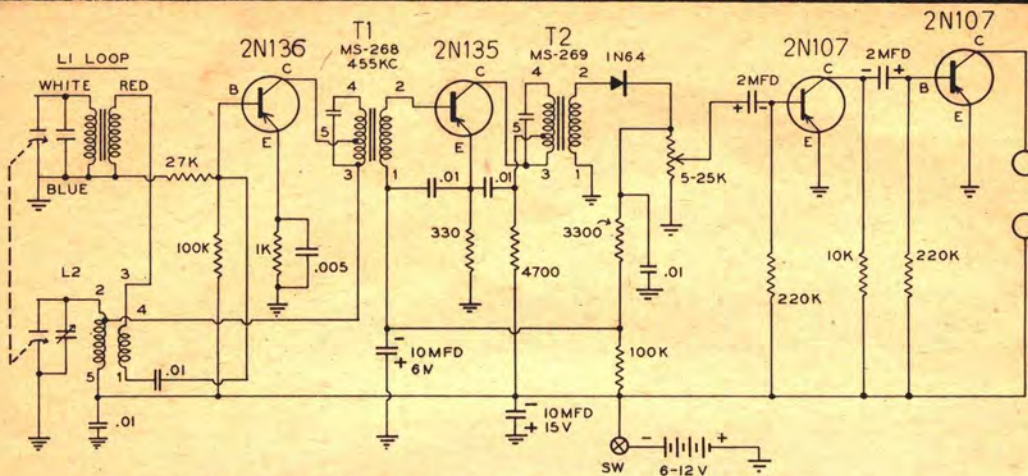

BUILD THIS FASCINATING SUPERHET RECEIVER

The introduction of the new, radically different Argonne POLY-VARI-CON ultra miniature variable condenser has made possible this truly subminiature superhet circuit that eliminates the need of outside antenna or ground. Lafayette has promptly designed the circuit published above to enable experimenters and engineers to build this unusual set that covers the entire broadcast band. You'll be amazed at the performance of this circuit which employs 4 transistors (2 high frequency types and 2 audio types) plus a germanium diode, 2 I.F. stages and 2 resistance coupled audio stages which feed into a miniature earpiece. The truly subminiature parts—from the 2-gang variable condenser that measures only 1-1/16" square x 5/8" to the tiny I.F.'s—will delight you. You can mount the entire set on a piece of bakelite board only 2 1/2" x 3 1/4" like the typical layout illustrated above. You can put the entire set in an inexpensive plastic box. We supply all the basic electronic components including a 2 1/2" x 4 1/4" board which can be cut to any convenient size leaving cabinet and physical layout to your ingenuity. Complete schematic supplied free.

COMPLETE LIST OF PARTS — LESS CASE

ALL PARTS MAY BE PURCHASED INDIVIDUALLY

QUANT.	STOCK NO.	DESCRIPTION	NET EA.
1	MS270	Poly-Vari-Con 2-gang Tuning Condenser	1.95
1	MS272	Loop Antenna	.95
1	MS265	Oscillator Coil	.79
1	MS268	1st IF Transformer	.89
1	MS269	2nd IF Transformer	.89
1	GE 2N-136	Transistor	3.10
1	GE2N135	Transistor	2.70
2	GE2N107	Transistors	ea. 1.25
1	C-601A	.005 Disc Ceramic Condenser	.09
3	C-601	.01 Disc Ceramic Condenser	ea. .09
1	CF120	2 mf 15V Electrolytic Condenser	.29
1	CF123	20 mf 15V Electrolytic Condenser	.33
2	CF100	2 mf 6V Electrolytic Condenser	ea. .29
1	VC25	25K ohm potentiometer w/switch	.69
1	1N64	Crystal Diode	.50
1	VS309	RCA Battery VS-309 9-volt	.84
4	MS275	Transistor Sockets	ea. .19
1	5206A	330 ohm 1/2 watt Resistor	.05
1	5206A	1000 ohm 1/2 watt Resistor	.05
1	5206A	3300 ohm 1/2 watt Resistor	.05
1	5206A	4700 ohm 1/2 watt Resistor	.05
1	5206A	10,000 ohm 1/2 watt Resistor	.05
2	5206A	100,000 ohm 1/2 watt Resistor	ea. .05
2	5206A	220,000 ohm 1/2 watt Resistor	ea. .05
1	MS293	Bakelite Mounting Board	.15
1		Volume Control Bracket	.05
1 Pkg.		Hardware, Consisting of Screws, Nuts, Bracket, Clip to mount battery, etc.	.25

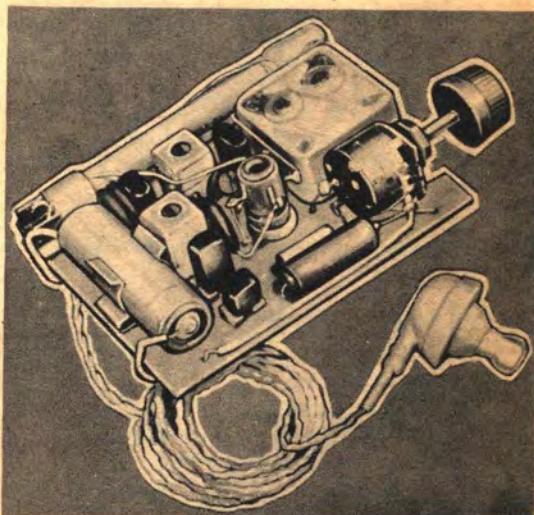

CI-101, Complete List of Parts as Listed Above, Less Earphones 19.10
MS-260, New Super Powered Dynamic Earphone—Ideal for Transistor Circuits Net 3.95

For Inexpensive Transparent Plastic Cases See PAGE 12.

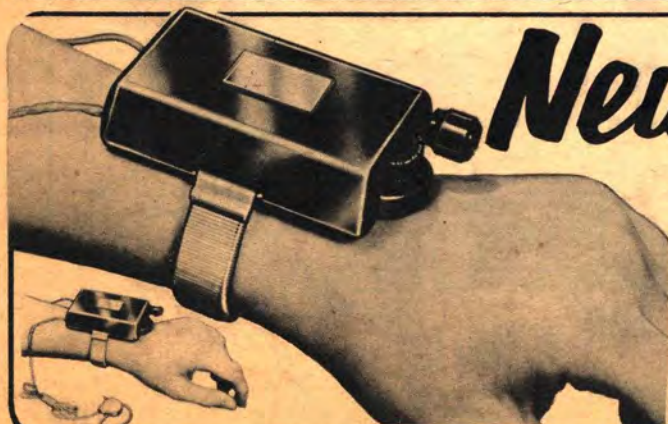

New

3 TRANSISTOR WRIST WATCH RADIO FOR EARPHONE OPERATION

← \$24.95
less battery

- COMPLETELY WIRED AND TESTED
- NEW REGENERATIVE RF REFLEX CIRCUIT
- NO OUTSIDE ANTENNA REQUIRED
- ONLY 2 3/4" x 1 3/4" x 3/4"

This all transistor radio is not a kit but is completely wired on a printed circuit board, and housed in a rugged plastic case with a stainless steel expansion wrist band. The new regenerative RF reflex circuit allows good selectivity and maximum sensitivity. In moderate signal areas up to 25 miles from a station no outside antenna is needed; the addition of a short length of wire will increase the range. It incorporates a 2 stage, transformer coupled amplifier which operates the sensitive earpiece. Covers entire broadcast band, 550 to 1600 kc. Operates on one long life mercury battery that lasts about 100 hours. Lightweight—weighs only 2.5 oz. Comes complete with earpiece but less battery. Shpg. wt., 1 lb.

WRIST WATCH RADIO WITH EARPIECE (less batteries) 24.95
MALLORY TR-145R BATTERY 1.49

TRANSISTOR Circuits & Kits



TWO TRANSISTOR POCKET RADIO RECEIVER KIT

With Regenerative Circuit and Transistor Transformer Audio Stage

Packed into a 2 1/2" x 3 1/2" x 1 1/4" Plastic Case, this Two Transistor Radio Receiver Kit offers many surprises. Regeneration "Soups Up" the performance of transistor Receivers. Simple transistor radios without regeneration are just crystal detectors followed by audio amplification and there is no R.F. amplification, and sensitivity and selectivity are always poor. In contrast With this, this Lafayette Kit, KT-68, utilizing a regenerative detector circuit and one stage of transformer coupled audio, gives you high gain and sharp selectivity. In the wee hours, you may pull in stations halfway around the country. At the beach, on picnics or camping trips, the set will deliver almost any station on the dial, with more than ample volume. It has more battery life than you would dream of getting from a tiny 15 volt battery. The kit comes complete, with TWO TRANSISTORS, Argonne specially designed Transistor Audio Transformer, Dynamic Earphone, Bakelite Board for mounting parts, Transparent Plastic Case, Condensers, Resistors, etc., including Schematic and instructions. Shpg. Wt. 1 1/2 lbs.

KT-68A—Complete kit with batteries but less earphone. Net 11.80
 KT-68—as above but with MS111 crystal earphone. Net 13.30
 MS-260—Super power, high output dynamic earphone for optimum results. Net 3.95



11.80

LESS EARPHONE

TRANSISTOR CODE PRACTICE OSCILLATOR KIT

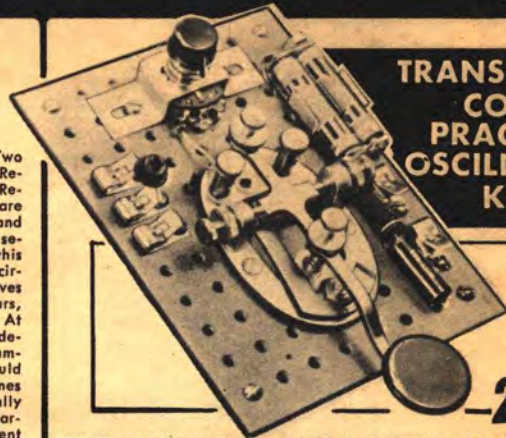

2.99

For those interested in mastering the international code, an audio tone oscillator is essential. The circuit of this transistorized feedback oscillator has the simplicity of the neon glow, the signal strength of the vacuum tube, and requires only two penlite cells for weeks of service. It may be used for solo practice, or two may send and receive with the same unit. Kit comes complete with Transistor, Telegraph Key, Resistors, Condensers, Masonite Board, etc., and Schematic Diagram. KT-72 Including batteries Shpg. Wt. 1 1/2 lbs. Net 2.99
 Cannon ECI—Single Headset Net 1.13

TRANSISTOR AUDIO AMPLIFIER

for SPEAKER OPERATION CLASS "B" PUSH PULL TRANSFORMER COUPLED 1/4 WATT POWER OUTPUT

Transformer coupling between transistor amplifier stages provides impedance matching and allows the use of less stages for the same overall gain than r-c interstage coupling. With the new Lafayette KT-69 Kit you can now build a self-powered (4-1 1/2 volt penlite cells) push-pull Class "B" transistor audio amplifier having a frequency response from 100-8,000 cps, and the overall power gain is in excess of 50 db. The Argonne Transistor Transformers used in the kit were specially designed for transistor circuits. An important feature of these transformers is their high inductance and low DC resistance. The total harmonic distortion at 400 cycles and 100 mw is 5%. Kit comes complete with 3 Transistors, 2 Argonne Push-Pull input and Output Transformers, Battery Holders, Resistors, Condensers, Aluminum Chassis, 3"x4"x1", and Schematic Diagrams. KT-69 Complete Kit Including batteries Shpg. Wt. 2 lbs. Net 1.395

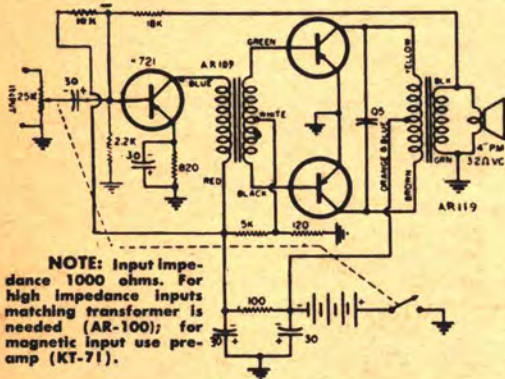
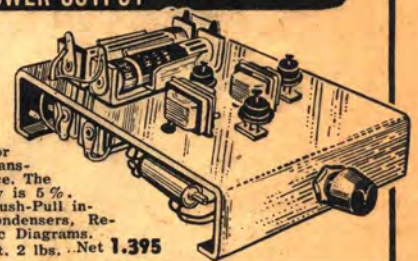

NOTE: Input impedance 1000 ohms. For high impedance inputs matching transformer is needed (AR-100); for magnetic input use preamp (KT-71).

TWO TRANSISTOR PREAMPLIFIER KIT

Humless — Distortionless — Noiseless

To you, the experimenter, with the Lafayette KT-71 you can now build a simple transistor preamp, in a matter of hours, for a cost considerably less than that of the commercially available single-tube magnetic pickup preamplifiers. The overall result will be a noiseless, and virtually distortionless amplifier. A straightforward circuit is used with grounded emitters and no tricky feedback (see diagram). The output impedance is very low and therefore long leads from the preamp cause no losses. The complete unit is mounted on aluminum chassis size 3"x4"x1" power supply and all. There are features to this little job not to be overlooked. The hum is practically zero. The hum pickup and microphonic susceptibility of the preamp are so low that the unit may be mounted directly below the arm on a changer. The kit comes complete with Two Transistors, Battery Holders, Resistors, Condensers, Aluminum Chassis, etc., and Schematic Diagram, and batteries. KT-71 Shpg. Wt. 2 lbs. Net 7.75

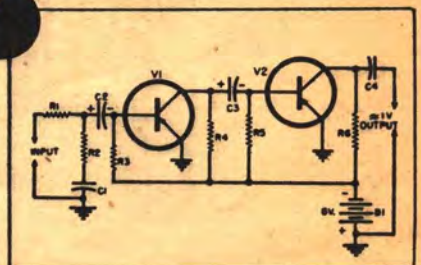
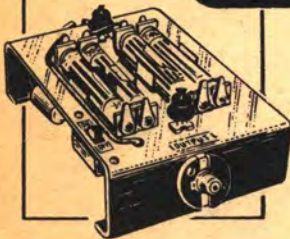

"BUILD THE GEIGAMP" CIRCUIT

Described in April 1956 Popular Electronics

A highly efficient Geiger Counter Transistorized Amplifier Circuit for speaker operation. This Transistor Geiger Amplifier will make your Geiger Counter clearly audible through a speaker with volume to spare. Just plug it into the Geiger Counter!

SEE TEXT OF ARTICLE FOR MISCELLANEOUS PARTS AND HARDWARE



Symbol	Stock No.	Description	Price
R1	VC-35	15,000 ohm subminiature pot	.49
R2	5206A	25,000 ohm 1/2W resistor	.05
R3	5206A	1,000 ohm 1/2W resistor	.05
C1	Aerovox type P-82	0.5 mfd, 200V metalized paper cap.	.62
V1, V2, V3	G.E. 2N107	Transistor @ 1.25 Ea.	3.75
T1	AR-109	Transistor driver transformer, 10K to 2K CT	2.95
T2	AR-119	Transistor output transformer, 500CT to 3.2 ohms	2.95
SW1	SW-14	SPST slide switch	.12
	SK-9	PM speaker 2 1/2" Dia., 3.2 ohm	1.29
	Mallory RM-1R	Battery 4 Ea. (In series) @ .35 Ea.	1.40
	ICA #29077	Cabinet Alum. 3 1/4" x 3 1/2" x 2" (cut to size)	.41

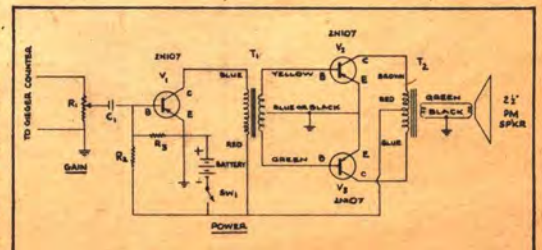

Learn About The Fascinating New Field Of Transistor Circuits

with the LAFAYETTE 13 IN 1 ADD A UNIT TRANSISTOR EXPERIMENTERS LAB KITS

LAFAYETTE EXCLUSIVE!

ADD A UNIT KITS

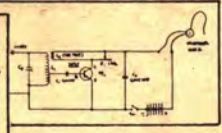
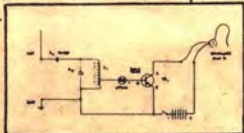
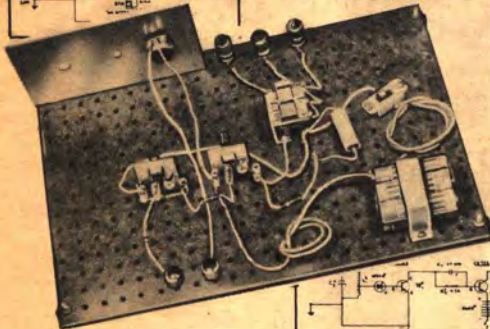
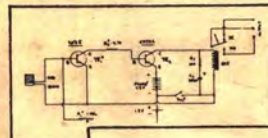
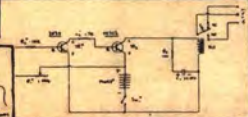
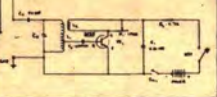
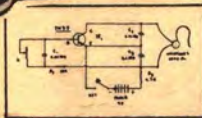
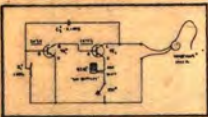
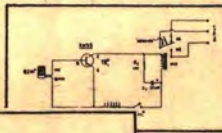
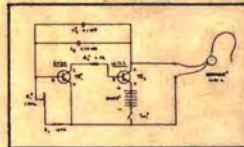
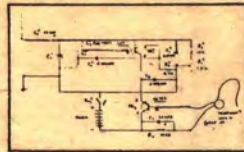
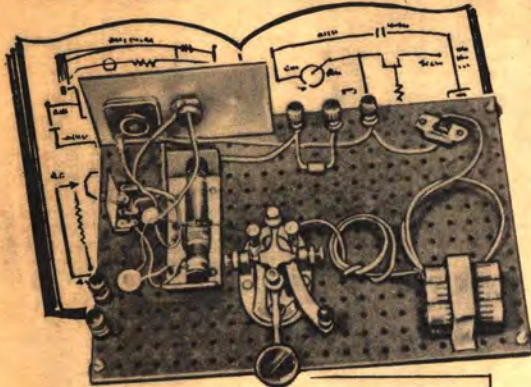

NEW! PRACTICAL! PROGRESSIVE!

Lafayette's transistor lab kits will introduce you to the new miracle of the electronic age — the transistor. You build practical operating units with both NPN and PNP transistors that teach you the fundamentals of transistor circuitry. Additional kits expand the usefulness of the basic kit without duplicating parts, so you can economically carry on further experiments. And Lafayette will have more expansion packages for you in the future. Start now!

THE 5-IN-1 BASIC KIT

- BUILD A SIMPLE RECEIVER
- BUILD A REGENERATIVE RECEIVER
- BUILD A CODE TRANSMITTER
- BUILD A LIGHT-POWERED RECEIVER
- BUILD A CODE PRACTICE OSCILLATOR

With the basic 5-in-1 Kit you can build any of these 5 projects. They are simple to assemble from the instructions and each in turn utilizes basic principles and some of the circuitry of the previous project. You build not only such basic units as receivers and code oscillator and transmitters but even a receiver operated by a sun battery! You learn to work with sub-miniature parts such as the exclusive Lafayette variable condenser that is only 3/16" thick by 1 1/2" square. Kit is complete with all parts, schematics, pictorials and instructions. Less headphone, tape and solder. Shpg. wt., 4 lbs.

KT-88 . . . 5-IN-1 BASIC KIT	Net 11.95
CANNON EC-1 . . . HEADPHONE	1.13
MS-273 . . . SENSITIVE MINIATURE EARPHONE	2.39

13-IN-1 EXPANSION KIT

- SENSITIVE PHOTO CELL RELAY
- RAIN ALARM
- LIGHT-POWERED OSCILLATOR
- ELECTRONIC RELAY
- SIMPLE PHOTO CELL RELAY
- HIGH GAIN RECEIVER
- ELECTRONIC METRONOME
- WIRELESS MICROPHONE

An exciting addition to the KT-88 kit to enable you to continue this fascinating and educational program of instruction, including the making of printed (etched) circuitry. The additional parts, diagrams and instructions (along with the parts in the basic 5-in-1 kit) cover the 8 added projects listed above. You'll be able to do such interesting things as broadcasting through your radio without connecting wires, detect moisture or rain, make light actuated relays and much more. And when you've done all these, you can look forward to more Lafayette expansion kits to increase the utility of the kits you already have. Kit is complete with all parts and instructions. Shpg. wt., 3 lbs.

KT-89 . . . EXPANSION KIT	NET 7.50
---------------------------	----------

Combination Deal

Net **18.75**

KT-88 and KT-89 Kit bought together

LORENZ REMOTE CONTROL TRANSMITTER KIT

FOR MODEL PLANES, BOATS AND CARS

14.95

Described in December 1954 Issue POPULAR ELECTRONICS

- LAFAYETTE'S entry for superb value in the popular remote control field!

The Lorenz Remote Control Transmitter is a highly efficient instrument designed to operate on the license free "Citizen Band" frequency of 27.255 megacycles. The only F.C.C. regulation is that an F.C.C. form 505 (supplied with kit) be filled out and sent to the nearest F.C.C. office. Designed for use with any "Citizen Band" remote control receiver such as Lafayette KT-84. Transmits signals which are picked up by the receiver for the purpose of remotely controlling model planes, boats, cars and other mechanical units. Its power output provides a wide range of control. Truly tops for value and dependable performance!

KT-87 . . . Less Batteries	Net 14.95
1—RCA VS 069 Battery	Net .53
2—RCA VSO-16 Batteries	2.28 Each Net 4.56



TRANSISTOR REMOTE CONTROL RECEIVER KIT

FOR MODEL PLANES, BOATS AND CARS

- THE MIGHTY MITE OF THE R/C FIELD!
 - WEIGHS 1 OZ.
 - 100% SUB-MINIATURIZED!
- Lafayette takes the lead in the popular R/C field with this super sensitive and efficient subminiature transistorized "Citizen Band" receiver kit. Operates on 27.255 MC and can be used with any "Citizen Band" remote control transmitter. A perfect mate for Lafayette Remote Control Transmitter Kit KT-87. Planned for compactness and sturdiness to withstand severe vibration and shock, yet weighs no more than 1 oz., 2-1/16" L x 1 1/2" W x 1-11/16" D, overall. Uses one 1-1/2 V and one 45V batteries. Battery size depends on size of model.

KT-84 . . . Less Batteries	11.75
----------------------------	-------

REMOTE CONTROL ESCAPEMENT

- At the lowest price anywhere!
- Weighs less than 1/2 oz.!

A fine, sturdy self-neutralizing escapement. Completely wired (not a kit). Converts electrical impulses from remote control receiver to mechanical motion for varying movement of plane, boat, or car. Very low current drain. Size: 1 3/8" L x 1/2" W. Shpg. Wt. 5 oz.

F-194	Net 2.45
-------	----------

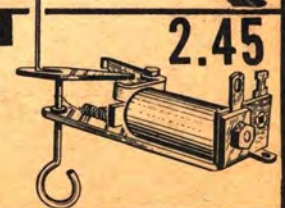

2.45

LAFAYETTE

Leads the Field in

TRANSISTORS Circuits Kits & Components



5 TRANSISTOR AUDIO AMPLIFIER KIT

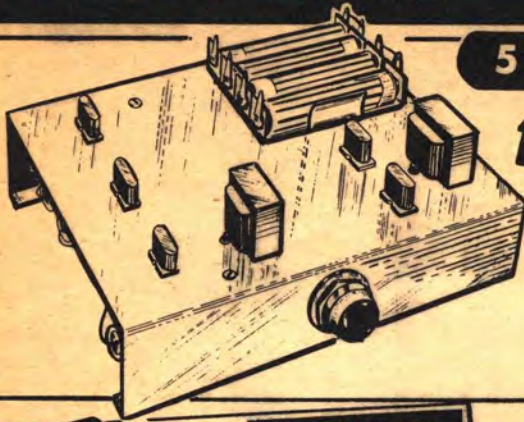

17.50

- Class B Push-Pull Output for speaker operation
- Preamp stage for magnetic cartridges
- Input for magnetic cartridge or crystal m'ke
- Input for crystal cartridge or tuner

Here is the first practical completely transistorized audio amplifier kit using 5 transistors and 2 special Argonne push-pull input and output transformers. Two inputs are provided, one for magnetic cartridges and crystal mikes, one for crystal cartridge and radio tuners. Operates on only 4-1 1/2 V penlite cells. The preamp stage is designed for such phono cartridges as the GE variable reluctance and other hi-fidelity magnetic cartridges, and provides extra amplification and equalization required. The preamp stage features extremely low distortion, noise and hum. The Argonne transformers are the highest quality. Specially designed for transistor circuits. A volume control is provided. Kit is complete with 5 transistors, two Argonne transformers, condensers, resistors, batteries, battery holders, chassis and all new necessary parts with schematic and pictorial diagrams and instructions for assembly and operation. Chassis size 5 1/4" L x 4" W x 1". Shpg. wt., 2 lb.

KT-82 Including batteries Net **17.50**

CADMIUM SULPHIDE PHOTOCELL RELAY KIT



11.50

Cadmium sulphide is another semi-conductor used as the active material in modern photocells. This kit utilizing the miniature clairez cadmium sulphide photocell has a high sensitivity, serves as the heart of burglar alarm systems; lighting control systems; door openers; motor or similar devices. The relay circuit is operated directly from the 110 volt A.C. line. Incorporates a 5823 cold-cathode tube resulting in quick relay operation at very low illumination levels. Relay contacts rated at 5 amps. Kit comes complete with clairez photocell, tube, resistors, condensers, metal case and chassis, size 3"x4"x5". Schematic diagram and instructions. Shpg. wt., 4 lbs.

KT-81 - Complete Kit Net **11.50**

TRANSISTOR POCKET RADIO RECEIVER KIT

Utilizing One Transistor and Crystal Diode Detector with New Miniature 365 mmf Variable Condenser

4.95

Here is an ideal low cost transistor pocket radio kit for students, hobbyists and the experimenter, who desire to obtain a practical knowledge of transistorized circuits. The circuit utilizes a Ferri-Loopstick and a specially designed miniaturized 365 Variable Condenser permitting the entire receiver to be built in a plastic case size 3" x 2" x 1". The 1N64 Crystal Diode is used as a detector. The transistor is connected as a grounded emitter amplifier. This receiver with a 50 foot antenna and good ground will bring in good reception over a 50 mile radius. The kit comes complete with transistor, crystal diode, battery holders, batteries, condensers, resistors, plastic case, etc., plus a 115 page book, showing more than 50 practical transistor circuits and How-To-Do-It-Instructions. Shpg. wt., 1 lb.



KT-80 Complete Kit (less earphones) **4.95**
 1 Miniature Crystal Ear Receiver MS-111 **1.49**

TRANSISTOR TELEPHONE PICK-UP AMPLIFIER KIT

TWO CAN LISTEN ON SAME PHONE CONVERSATION



With this ingenious Kit you can build a tiny transistorized telephone pick-up amplifier, with which two people can listen in on telephone conversations without the need of an extension phone. Also serves as a high gain amplifier to feed into a tape recorder, for recording telephone conversations. Can also be used as a portable amplifier with crystal microphone and matching transformer when desired. The circuit utilizes a transformer coupled audio for high gain and two R-C, coupled stages. Kit comes complete with 3 Transistors, Transistor Audio Transformer, Condensers, Resistors, etc., and Plastic Case. Size: 2 1/2" x 1 1/2" x 3 1/2". Including batteries Shpg. Wt. 2 lbs.

KT-76 Complete Kit (Less Telephone Pick-Up and Earphones) Net **9.45**

MS-16 Telephone Pick-Up Net **2.95**

MS-111-Crystal earphone for above **1.49**

MS-260-Super power high output dynamic earphone for optimum results Net **3.95**



BUILD A TRANSISTOR VOLTMETER

ESSENTIAL PARTS LIST



A Simple Transistor Amplifier Circuit Which can be Added to Standard 0-1 ma Meter To Increase Sensitivity By a 10:1 Ratio Increase Sensitivity to 100,000 Ohms Per Volt on DC and 10,000 Ohms Per Volt AC

Almost every serviceman, ham, school or commercial laboratory has 0-1 milliamper meter on hand. A compact and rugged voltmeter of High Sensitivity, 100,000 Ohms Per Volt DC and 10,000 ohms per volt AC, has been designed using two Transistors in cascade to operate a 0-1 milliamper movement (powered by a single 1.5 volt penlight cell) and thus increase the sensitivity of the meter by a factor of 10 to 1. It can be used in place of a VTVM. Full scale ranges are 1, 10, 100 and 1,000 volts DC at 100,000 Ohms Per Volt, and 10, 100 and 1,000 Volts AC at 10,000 Ohms Per Volt. YOU CAN PURCHASE ANY OR ALL THE PARTS NEEDED TO BUILD THIS HIGHLY SENSITIVE INSTRUMENT.

KT-74-COMplete LIST OF PARTS Net **14.95**

1	0-1 milliamper Meter #DS-10	4.50
2	CK722 Transistors	@ .99 ea. 1.98
2	Transistor Socket	@ .19 ea. .38
1	Roytheon CK705 Diode (use 1N66)	.65
1	0.5 of Paper Capacitor #X1269	.47
1	S.P.S.T. Slide Switch #SW-14	.12
1	D.P.D.T. Slide Switch #SW-17	.32
1	330K 1/2 watt Resistor 5%	.10
1	4.7K 1/2 watt Resistor 5%	.10
1	470 ohms 1/2 watt Resistor 5%	.10
1	1,000 ohm wirewound Pot. Clarostat 58-1000	.82
1	200 ohm wirewound Pot. Clarostat 58-200	.82
1	82K 1/2 watt Resistor 5%	.10
1	15K 1/2 watt Resistor 5%	.10
5	20 Meg. 1/2 watt Resistor 5%	@ .10 ea. .50
3	3.3 Meg. 1/2 watt Resistor 5%	@ .10 ea. .30
1	1 Meg. 1/2 watt Resistor 5%	.10
1	100K 1/2 watt Resistor 5%	.10
1	10K 1/2 watt Resistor 5%	.10
1	Bakelite Case 6 3/4" x 5 1/4" x 2 1/4" and Aluminum Panel (undrilled)	2.95
1	115 Page Book, showing Schematic and detailed instructions, as well as 50 other practical Transistor Circuits and How-To-Do-It Instructions	.50



LAFAYETTE

PIONEER • LEADER in TRANSISTOR KITS, CIRCUITS and PARTS



TRIUMPHS AGAIN!

NEW! TRANSISTOR CHECKER KIT

ANOTHER LAFAYETTE FIRST!

7.95

- Checks P-N-P and N-P-N Transistors
- Indicates at a glance — good, bad, high leakage and shorts
- Current gain checked with flip of switch

Lafayette forges ahead in the transistor field with its amazing new P-N-P and N-P-N Transistor Checker. Indispensable to the experimenter, dealer, serviceman and kit builder. Because of the difficulties encountered in transistor manufacture, it is almost impossible to control close tolerances. Lafayette Transistor Checker KT-86 is a must that saves you frustration and time. It checks both P-N-P and N-P-N transistors for leakage and shorts, and indicates at once whether transistor is good or bad. A flip of the switch and the current gain of the transistor is immediately shown on a clear meter dial. An ideal quality check! Pioneer and leader in the field of transistor kits, circuits and parts, Lafayette takes pride in offering this reliable checker to the transistor field at a price which only Lafayette know-how can make possible.

KT-86 — Transistor Checker Kit

\$7.95



SENSITIVE TRANSISTORIZED FIELD STRENGTH METER CIRCUIT

Described in July and August 1955 Issues of The Aerovox Research Worker*

LIST OF PARTS

Symbol	Stock No.	Description	Net Price Each
C1	C-601	.001 ufd Disc Ceramic Cap.	.09
C2	Bud LC 1643	35 ufd Variable Capacitor	1.77
C3	C-601	.005 ufd Disc Ceramic Cap.	.09
J1	Amphenol 83-1R	Connector	.48
J2	Mallory A-2	Jack	.10
R1		2700 Ohms \pm 5% $\frac{1}{2}$ W. Resistor	.10
R2		47,000 Ohms \pm 5% $\frac{1}{2}$ W. Resistor	.10
R3		1,000 Ohms \pm 10% $\frac{1}{2}$ W. Resistor	.05
R4		5,000 Ohms WW control	.91
R5	Mallory R5000L	100/1 Shunt (see Issue)	
R6		10/1 Shunt (see Issue)	
S1	Centralab PA 2000	Switch, SP, 8 pos.	1.62
S2	Centralab 1461	Switch, SP, 3 pos.	.88
S3	SW-12	Switch, Toggle, DPST	.56
X1	Sylvania 2N35	Transistor, N-P-N	2.55
D1	GE 67A	Diode	1.00
B1	Burgess 422	3 Volt Battery	.42
B2	Burgess Z	1.5 Volt Battery	.08
M	DS-11**	0-200 ua Microammeter	4.95
L1	ICA 29443	Case 7" x 5" x 3" (undrilled) Coils wound to resonate over desired frequency ranges	1.69

Parts May Be Purchased Individually

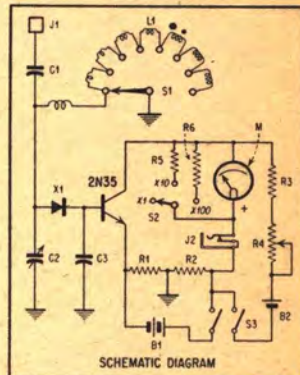

CONELRAD TRANSISTOR POCKET RADIO FOR CIVIL DEFENSE BANDS

Described in
April 1955 Issue of
Radio Television News

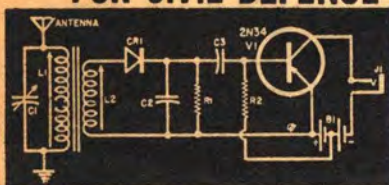

List of Principle Parts

Symbol	Stock No.	Description	Price
R1, R2	5206A	220,000 Ohm $\frac{1}{2}$ W. Resistor 2 @ .05 =	.10
C1	C-736	50-400 ufd Padder Capacitor	.35
C2	Aerovox P83Z	.005 ufd, 200 Volt Capacitor	.26
C3	CF-143	25 ufd-25 Volt Electrolytic Cap.	.35
L1, L2	MS-11	Antenna Coil	.39
S1	Mallory A-1	Open Circuit Jack	.38
CR1	Raytheon 1N34	1N34 Germanium Diode	.65
B1	Burgess Z	1 1/2 Volt Penlite Batteries 2 @ .08 =	.16
V1	GE 2N107	Transistor	1.25
	KT-48A	Complete List of Parts As Above	3.89

Parts may be purchased individually
Choice of Chassis, Case and Hardware left to builder.
Also Required: Single Earphone — MS-111..... 1.49
plus 4700 ohm $\frac{1}{2}$ W Resistor..... .05
(Connect across output of receiver)
For optimum performance we recommend:
Lafayette Super Power Dynamic Earphone MS-260..... 3.95

A TRANSISTOR TIMER

Described in October 1953 Issue
of Radio Television News

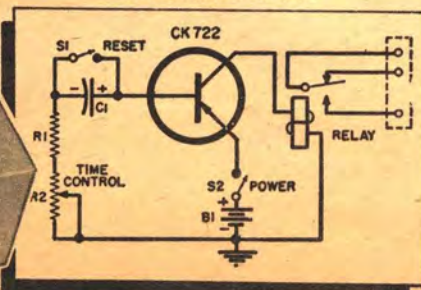

A NATURAL FOR THE PHOTO LAB

A "natural" for the photo lab, this timer requires no external power source and offers a wide selection of timing intervals. Most electronic timers suffer from two disadvantages — they require a source of line voltage and they become extremely warm when left on for any length of time. Both disadvantages result from the necessity of using vacuum tubes and comparatively high voltages. With these problems in mind, an effort was made to design a timer that would meet the following specifications: (a) Simple in construction and wiring; (b) Easy to operate (c) Completely self-contained, using no line power; (d) Generating as little heat as possible; (e) Rugged, yet compact.

Parts List

Symbol	Stock No.	Description	Net Price Each
C1	CF-126	100 ufd 15V Electrolytic Cap.	.45
R1		2000 Ohm 1/2W Resistor 5%	.10
R2	Mallory U35	50,000 Ohm Potentiometer	.82
S1	SPST	Push-Button Switch	.48
S2	SW-10	SPST Toggle Switch	.30
B1	V5068	6 Volt Battery	.60
	MS-175	Battery Holder	.20
	Advance SV 1C/5500D	Relay, 5500 Ohm Coil	6.98
	Raytheon CK-722	Transistor	.99
	MS-252	Transistor Socket	.32
	ICA 29440	Case, 6" x 4" x 3"	
		Gray Hammettone (undrilled)	.97
	9885	Knob	.18
	MS-228	Terminal Strip	.10
		4-36 x 3/8" Screws (4)	
		4-36 Nuts (4)	

KT-45A

Complete List of Parts as Above
Parts May Be Purchased Individually

12.39



New! GE TRANSISTOR TESTER



39 50

- A LOW COST TRANSISTOR TESTER PLUS
- 5 POPULAR RADIO-REPLACEMENT TRANSISTORS

An attractive completely assembled transistor tester that checks all PNP and NPN transistors for Good-Bad-Leakage and Gain. Has easy-to-read colored scale that indicates GOOD-FAIR-POOR on LEAKAGE test, and a separate graduated scale for GAIN test. Meter can be zero adjusted for additional accuracy. Includes 5 popular quality radio-replacement transistors consisting of high frequency RF-IF types 2N137, 2N136 and 2N135, and of audio types 2N78 and 2N44. Complete with easy-to-follow instructions and Transistor Interchangeability Information for the popular transistor radio sets.

GE Transistor Tester — Complete Net **39.50**



Smallest PM Speaker Made

FOR TRANSISTOR AND SUBMINIATURE CIRCUITS

SIZE: 1 1/2" Dia. x 15/16" Deep

At last — the tiny super speaker you've been searching for! Experimenter's, kit builders, and circuit designer's delight for Transistor and subminiature receivers, amplifiers, and circuits. The smallest PM speaker made! Only 1 1/2" diameter by 15/16" deep. Alnico 5 magnet — 10 ohm voice coil — total weight only 1 7/8 oz. Surprising frequency range and output for its size. Mounts at front by four 1/8" mounting holes on 1-9/32" x 1-9/32" mounting centers. A true Lafayette first super value at this unbelievable low price! Shpg. wt., 6 oz.

SK-61 Net **1.95**

SPEAKER WITH OUTPUT TRANSFORMER

With 3/8" x 7/8" x 11/16" 3/4 oz. matching transformer — matches 2000 ohms to 10 ohm voice coil. (Suitable for most transistor outputs). Shpg. wt., 8 oz.

SK-62 Net **2.95**

VECO THERMISTORS — VARISTORS

- MOST VERSATILE CIRCUIT ELEMENTS EVER DEVELOPED!
- A BOON TO THE EXPERIMENTER AND ENGINEER

These tiny semi-conductors are acutely sensitive to thermal or voltage changes. Thermistors and Varistors have great stability and have almost unlimited use in temperature measurement, control and compensation, switching, flow and power measurement, fire detection, gas analysis, time delay, overload protection, voltage regulation, feedback amplifier gain controls, volume speech limiters, etc.

UNIT	Type	Ohms	°C	OC	AC/DC	°C	Secs.	Ohms. Net
14X2	Washer	38 ± 10%	-4.6%	150	3.2 Amp.	0.1 W.	19	1 1.88
21W4	Washer	130 ± 10%	-5.2%	150	1.7 Amp.	0.1 W.	13	4 .98
23E3	Disc	310 ± 10%	-4.6%	125	200 MA.	6.0 MW	20	8 2.03
31A1	Bead	1250 ± 10%	-4.0%	150	25 MA.	0.1 MW	1	30 2.40
31D7	Disc	1200 ± 10%	-4.0%	150	25 MA.	0.1 MW	1	30 2.40
34A3	Bead	3500 ± 30%	-4.6%	300	130 MA.	6.0 MW	20	30 1.13
47A1	Bead	71,000 ± 30%	-5.6%	300	25 MA.	1 MW	25	150 2.25
51R2	Rod	100,000 ± 10%	-5.2%	150	13 MA.	2.5 MW	20	300 1.04

Test Requirement: 20.0 Volts ± 20% AC or DC must be applied across unit to pass 15.0 MA.

Test Requirement: 29.5 Volts ± 9% AC or DC must be applied across unit to pass 15.0 MA.

Varistor; all other Thermistors

Cold Resistance Ro at 25°C with no self heating.

Maximum Safe Continuous Temperature

Maximum Continuous Current

Dissipation Constant

Thermal Time Constant

Minimum Circuit Series Resistance. Excluding Thermistor

THERMISTOR-VARISTOR EXPERIMENTER KITS

Kit 168 — Includes 14X2, 21W4, 23E3, 31A1, 31D7 and 51A4 (47A1) thermistors, and 166-(124W1) Varistor. Complete with specs and technical data. **\$12.39 Value**

Kit 168A — Includes 14X2, 21W4, 23E3, 31A1, 31D7, 34A3, 47A1, 51R2 thermistors and 114W4, 124W1 varistors. Complete with specs and technical data. **\$17.18 Value**

SAFEGUARD YOUR HOME — BUILD A THERMISTOR FIRE ALARM

AN EFFECTIVE AND INEXPENSIVE SYSTEM TO WARN OF FIRE IN ITS EARLIEST STAGES

Described in March, 1956 Popular Electronics

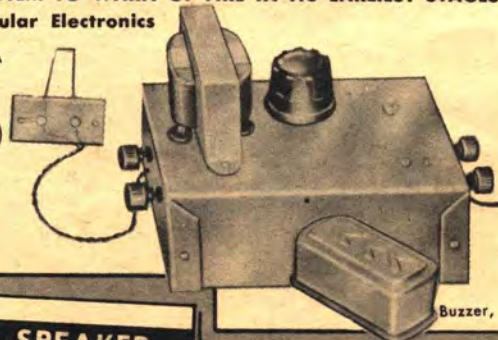
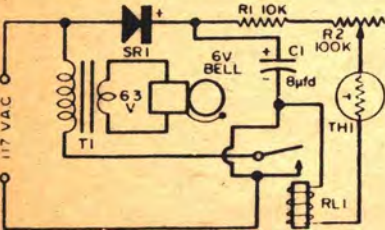

Buzzer, miscellaneous grommets, machine screws, wire and solder not supplied.

Symbol	Stock #	Description	Net Price Each
C1	X-164	8 mfd., 450 volt electrolytic capacitor	.73
R1	5206A	10,000 ohm, 1/2 watt resistor	.05
R2	IRC Q11-128 Advance	100,000 ohm potentiometer	.82
RL1	SO-1C-10,000D	Sensitive relay	3.87
SR1	RE-12 Stancor	65 ma selenium rectifier	.57
T1	P-6134	Filament transformer	1.71
TH1	Veco Type 51R2	Thermistor	1.15
	EL-13	Line cord & plug	.19
	ICA 29441	Case 5 1/4" x 3" x 2 1/8"	.94
	#13082	Insulated binding posts (4) @ 18¢	.72
	MS-232	2-lug tie point 1/4" knob for potentiometer	.02

RCA • RCA 2 3/4" PM SPEAKER •

REGULAR \$4.90 VALUE

This is the same miniature speaker used in hundreds of thousands of personal portable radios! Leave it to Lafayette — to offer it at an unheard of price! A genuine RCA 2 3/4" PM speaker — 1 oz. Alnico 5 magnet — 12 ohm voice coil — total weight only 4 oz! Only 1 1/4" overall depth — pre-attached for mounting. Just what you've been seeking for miniature equipment — receivers — amplifiers — intercoms — transistor circuits — wherever a really small, efficient speaker is needed! Shpg. wt. 8 oz. SK. 39 in lots of 3, each, Net **1.69**

Single, each Net **1.79**

CHICAGO TRANSISTOR TRANSFORMERS

1/4" x 3/8" x 3/8"

Smallest iron core audio transformer ever built! For Transistor and low power applications. Weighs less than 1/10 oz.! All 3/8" x 3/8" x 3/8" except UM-110-1/4" x 3/8" x 3/8".

Part No.	Use	Pri. Imp.	Sec. Imp.	Pri DC Res.	Sec DC Res.	Net
UM-110	Interstage	20,000	1,000	1675	285	5.59
UM-111	Output	1,000	50/60	120	9	3.82
UM-112	Input	200,000	1,000	4000	195	6.17
UM-113	Interstage	20,000	1,000	1350	205	4.26
UM-114	Output	500	50/60	70	9	3.82



LAFAYETTES NEW UNBEATABLE PRICES!

Triple Purpose Slim Crystal Microphone

NEW

**COMPLETE SET
MICROPHONE
SWIVEL ADAPTER
LAVALIER CORD**



5.95



- **UNIVERSAL DESIGN — MAY BE HAND-HELD, STAND-MOUNTED OR SUSPENDED BY LAVALIER CORD. ALL ACCESSORIES FURNISHED.**
- **FREQUENCY RESPONSE 60-10,000 CPS • ON-OFF SWITCH**

Here is a unique design in a high quality crystal microphone. It is slim in design, measuring only 6" long including cable connector. Mike itself measures only 4 3/8" L x 1 1/8" max. diam. and weighs only 6 oz. The special swivel stand adaptor fits on all standard 3/8"-27 stands and clamps to body of mike. Clamp is rotatable through 180°. The lavalier cord fits comfortably around neck, is adjustable for proper length and terminates in a bracket to hold microphone in proper position. This makes it ideal for lectures, demonstrators, etc., who must move about with both hands free. Has wide range smooth response for both music and voice and omnidirectional polar pattern. Locking type on-off slide switch is built-in. Attractive brushed satin-finish. Nothing like this has ever been offered before for less than about 3 times our price. Complete package consists of microphone, 7 ft. detachable cord, with cable connector, swivel stand adaptor and lavalier cord with bracket. Shpg. wt. 2 lbs.

PA-31..... Singly, Each **5.95**..... In Lots of 3, Each **5.65**
 PA-32—DESK MICROPHONE STAND..... **\$1.49**

NEW! EXCLUSIVE!

SLIM DYNAMIC MICROPHONE

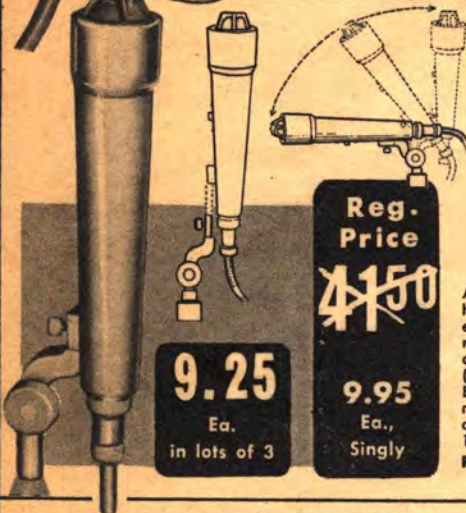

Reg. Price 4.50

9.25 Ea. in lots of 3
9.95 Ea. Singly

Again Lafayette leads the field with the latest design in slim type microphones. Here is a high-output dynamic mike of exceptional quality packed with both electrical and mechanical features at a price 1/3 that of any comparable microphone on the market today. Has very smooth response from 50-11,000 cycles. Built-in external switch gives you choice of either high impedance (50,000 ohms) or low impedance (250 ohms). Omni-directional tilttable head. Bracket has standard 3/8"-27 thread for use on stand. This bracket is instantly removable so mike can be handheld. Has cast case with satin-chrome finish and acoustically treated grille head. Ruggedly constructed. Size: 8" long, 1 1/4" diam. barrel. Shpg. wt. 2 lbs.

PA-29..... In lots of 3, Each **9.25**
 Singly, Each **9.95**

MICROPHONE VOLUME CONTROL ADAPTER

4.09



Designed to reduce or increase relative volume at the microphone. Used in high impedance circuits using shielded single conductor cable only. Reduces volume to workable level—reduces feedback noises. Employs standard microphone connectors—one off-center for easy mounting on mikes used with stands. Shpg. Wt. 8 ozs.

SWITCHCRAFT—329.....Net **4.09**

MICROPHONE SWITCH



Attaches between male and female of 75 series connectors. Push-to-talk or slide switch for permanent connection.

Amphenol 75-MC15..... **1.09**

ATLAS "FULL GRIP" MICROPHONE STANDS

The "full-grip" clutch mechanism and smooth-acting telescoping tube, permit fast, quiet adjustments at all times without wear or slipping. Height adjustment from 35" to 64". Gray swivel base gives maximum stability and includes self-leveling, shock-absorbing base pads plus three additional "anti-tip" points located between the base pads. Full chrome plated tube assemblies for lifetime wear. Base diameter 10". All models terminate in a 3/8"-27 thread. Shpg. wt. 9 lbs.

Atlas Model MS-10C..... **5.73**

Same as above except heavier and with tube extension to 65". Shpg. wt. 12 lbs.

Atlas Model MS-12C..... **6.17**

Same as above except full chrome finish on base and tube.

Atlas Model MS-11C..... **7.64**

ATLAS "VELVET ACTION" DESK STANDS

A decorative and fine appearing stand suitable for use on a banquet table. Uses "full-grip, velvet action" control adjustable from 18" to 32". Full chrome finish base and tube assembly. Base diameter 8". Supplied with base pads.

Atlas Model TS-6—Shpg. wt. 5 lbs..... **5.29**

MODEL DS-5 FIXED. Same finish and workmanship as floor models. 6" fixed height. Base diameter 6". Felt base pads included.

Atlas Model DS-5—Shpg. wt. 2 lbs..... **1.76**

MODEL DS-7 ADJUSTABLE. From 8" to 13". Uses heavy duty 3/8" and 1/2" tubing.

Atlas Model DS-7—Shpg. wt. 3 lbs..... **2.94**

AMPHENOL MICROPHONE CONNECTORS



SERIES 75. PRESSURE TYPE—SINGLE CONTACT
 Polished chrome plated brass fittings with 3/8"-27 threads

Type	Fig.	Description	Each
75-MC1F	A	Female with coupling ring	.31
75-MC1M	B	Male. Fits above connector	.21
75-PC1M	C	Male. Non-shorting, chassis mount. Fits MC1F	.23
75-CL-PC1M	D	As above, except closed circuit	.33
75-MC1F-A	E	Angle type, female connector coupling ring. Use with PC1M, etc.	.63
75-MC1P	F	Adaptor. Connects MC1F to standard phone plug	.30



"Y" CONNECTOR

Has 2 male and 1 female. For use when using more than 1 mike or speaker from single circuit.

MS-84.....Net **.85**

FLEXIBLE GOOSENECK

Attaches to any mike stand. Can be used where moderate adjustment is required. 3/8"-27 thread; male and female ends. Chrome finish.

ATLAS GN-13—13" long..... **1.62**

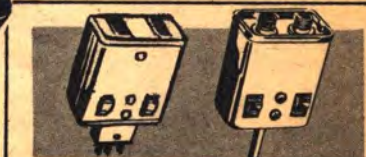

SWITCHCRAFT "MINI-MIX"

Miniature 2 Input Audio Mixer

Accommodates 2 high impedance inputs. Separate gain controls for mixing. Connected directly to equipment. No external cables. Minimum lead-length inside shielded housing minimizing "stray-pickups". Ideal for use with tape, wire or disc recorders, amplifiers, musical instruments, etc. Size: 2-1/18" x 1-13/16" x 1-1/16"

NO. 320—WITH MICROPHONE CONNECTOR INPUTS AND OUTPUTS..... **4.67**

NO. 310—WITH PHONE JACK INPUTS AND PHONE PLUG OUTPUT FITTING..... **4.67**

No. 315—with phone jack inputs and microphone connector output mating with standard mike connectors. **\$4.67**

No. 325—for recorders or amps using Jones connectors including recessed type in Wehcor Tape Recorders. **\$5.85**

No. 8266—cable assembly with plug and jack to use No. 310 where equipment jack is recessed **\$2.20**

MICROPHONES

*Fine Quality
At History Making Prices!*

A BUY OF A LIFETIME HIGH QUALITY TOP NOTCH CRYSTAL MICROPHONE

COMPARE IT WITH
ANY MIKE AT
2 to 3 TIMES
THE PRICE

3.95 each
in lots of 3
Singly, ea. 4.25

Lafayette makes history with a high quality **CRYSTAL MICROPHONE** at a price that is 60% less than any comparable Crystal Microphone on the market today. Excellent for PA systems, home recorders and general applications. Frequency response 30 to 10,000 cycles. Output level—52 db. provides ample output for use with low gain amplifiers. Uses quality moisture sealed crystal; Die cast case in rich green baked enamel finish, with chrome grill. Completely equipped with 5 feet of shielded cable. Mike may be used on any stand with 5/8"-27 thread. Grill diameter 2 3/4", depth 4/4", height 4 1/2". Shpg. Wt. 3 1/2 lbs.

STOCK NO.
PA-24

PA-24—In lots of 3, each..... **3.95**
Singly, each..... **4.25**



STUDIO CRYSTAL MICROPHONE

- DUAL CRYSTAL CARTRIDGES
- ALL DIRECTIONAL
- FINE QUALITY
- HIGH OUTPUT

6.95
ea. in lots of 3,
single, each
7.25

Here is a microphone with a 360° pickup, and the added power and sensitivity of two individually shock mounted and phased crystal cartridges. This arrangement assures you of maximum pickup from all sides. Swivel mounted to give fuller flexibility. Case is chrome plated. Standard 5/8"-27 thread. Overall size 7" H x 3" W complete with 4 ft. cable. Shpg. wt. 4 lbs. PA-17—
In lots of 3, each **6.95**
Singly, each..... **7.25**



CRYSTAL MICROPHONE CARTRIDGE

- REPLACEMENT FOR
ASTATIC SHURE, AND
MANY OTHER POPULAR
MICROPHONES

1.95

A universal crystal microphone cartridge with heavy flexible rubber cushioned rim designed for speedy, economical repair. Fits tens of thousands of the most popular microphones such as the astatic JT 30 etc. Overall diameter 2 1/8", depth 1/2". Output—52 db. Excellent frequency response. Shpg. wt. 8 oz.
PA-27—In lots of 3, each..... **1.75**
Singly, each..... **1.95**



A Fantastically Low Price! HIGH OUTPUT DYNAMIC MICROPHONE WORTH MANY TIMES ITS PRICE

List Price
~~\$47.80~~
12.45 ea.
In Lots of 3
Single, ea. **12.95**

AT LAST! A HI-FI Dynamic Mike for Public Address etc. at a price you'd expect to pay for a good crystal mike!
Lafayette went abroad to obtain a high quality **DYNAMIC MICROPHONE** at a price that is 70% less than any comparable dynamic microphone on the market today. Exceptionally fine for public address, recording and other general purpose use. Substantially flat response, 60-10,000 cps, assures faithful reproduction of speech and music. Impedance 40,000 ohms ±15% at 1000 cps. Output Level—55 db. Die cast metal case finished in light grey and fine chromium. Compact and light weight. Net Wt. 1 lb. Head at fixed tilt of 15°, equipped with 6 ft. well shielded low-loss special vinyl-jacketed cord. Standard 5/8"-27 thread. Dimensions 1-23/32" high, 2" wide, 3 3/4" deep. Shpg. Wt. 3 lbs.



STOCK NO.
PA-19

LAFAYETTE'S OWN LAPEL MICROPHONE

- FULL —55 db. OUTPUT LEVEL!
 - IDEAL GENERAL PURPOSE MIKE!
- Reg. 16.00 Value

Most compact—specially engineered crystal microphone. Attaches to the lapel. Only 1 1/8" in diameter. Fantastically light weight—weighs only 1/2 ozs. including 5 feet cord! Exceptional frequency responses provides high level speech intelligibility. Output level—55db. "Sealed-in" moisture proof crystal—pressure actuated. Handsome, heavily chrome plated case and clip for attaching to lapel. Ideal for inexpensive P.A. systems—hams—home recording—general purpose. High impedance. Includes 5 ft. of extra light weight shielded single conductor cable. Shpg. Wt. 1 lb. PA-18..... **Net 2.95**



*Never Before
At This
History Making
Price!*

A LAFAYETTE SCOOP!

Top Quality

CRYSTAL
MIKE

2.95

New, attractively styled crystal microphone for all general applications — public address, home recordings etc. Frequency response 30 to 10,000 cycles. Output level — 52 db; tilting head. Die cast case with rich gray baked enamel finish. Chrome grill. Completely equipped with 5 feet of shielded cable. Grill dia. 2 1/4", depth 3 3/4", height 4". Shpg. wt. 3 lbs. One of the best buys in the country.
PA-28..... Each **2.95**



MINIATURE CRYSTAL MICROPHONE

1.95

Here's a typical Lafayette special for the experimenter, student or dealer. An extremely sensitive and small crystal microphone used in hearing aids and other small apparatus. Can be used as lapel mike—miniature transmitter mike—for concealed locations, etc. Its size and performance gives it joint versatility. Brand new. Size only 1 3/4" Diam. x 5/16" deep. Imported to save you money.
MS-108..... **Net 1.95**



LAFAYETTE'S SPECTACULAR MULTITESTER VALUES

**HIGH SENSITIVITY 20,000 OHM PER VOLT DC
10,000 OHM PER VOLT AC MULTITESTER**

19.95

LOOK AT THESE FULL SCALE RANGES!

D.C. VOLTS: 0-6; 0-30; 0-120; 0-600; 0-1200;
0-6000 Volts—A.C. VOLTS: 0-6; 0-30; 0-120;
0-600; 0-1200 Volts—RESISTANCE: 0-10K; 0-100K;
0-1 Meg; 0-10 Megohms—D.C. CURRENT: 0-60
Microamp; 0-6; 0-60; 0-600 Millamps—DECIBEL:
-20 to +17 db (0 db = 0.774V)—CAPACITY:
.0001 - .01; .005 - .15 mfd—INDUCTANCE: 20-
2000 millihenry—OUTPUT RANGES: 0-6; 0-30;
0-120; 0-600; 0-1200 Volts

The new Lafayette high sensitivity Multitester is a complete instrument (not a kit). In addition to its unusual sensitivity of 20,000 OHMS PER VOLT ON D.C. AND 10,000 OHMS PER VOLT ON A.C., and the extraordinary number and scope of its ranges, it is packed with features that would make it cost at least twice as much if made in this country. Uses 1% precision resistors, silver contacts on selector switch, 35 ua 3" meter. Dependable, rugged and accurate. Even the test leads are heavy duty with high voltage insulation. Voltage source required for low capacity range is 120V A.C., for high range capacity and inductance scale is 6V A.C. Attractive plastic front with metal bottom. Size: 6 1/4" x 4 1/4" x 2 1/2". Complete with batteries and leads. Shipping weight 4 1/2 lbs.

RW-30A..... Singly, Each 19.95
In lots of 3, Each 19.25



NEW POCKET AC-DC VOM MULTITESTER
2,000 Ohm per Volt Sensitivity on both DC and AC

**160 ua 3" METER
1% PRECISION RESISTORS
SILVER CONTACT SELECTOR
SWITCH**

7.95

FULL SCALE RANGES

DC Volts: 0-10; 0-50; 0-500; 0-1000 Volts —
AC Volts: 0-10; 0-50; 0-500; 0-1000 Volts —
DC Current: 500 ua and 500 ma—Resistance:
0-10K; 0-1 Meg—Decibels: -20 to +22;
+20 to 36 db (0 db = 0.775 V) — Capacity:
250 mmfd to .2 mfd — .005 mfd to 1 mfd —
Output Ranges: 0-10; 0-50; 0-500; 0-1000 volts

Best Buy in America! A very accurate and sensitive VOM. This Multitester is a complete instrument (not a kit) with high quality and sensitive 160 microamp meter; 2000 ohm per volt on both AC and DC. Single selector switch, 1% precision resistors, 3" meter. Features extreme versatility, accuracy and ruggedness. In attractive plastic front panel, with metal bottom for ruggedness and shielding. First capacity range requires 50 volt AC source. Second capacity range requires 10 volt AC source. Size 4 1/4" x 3 1/2" x 1 1/4". Complete with test leads and batteries. Shipping weight 4 lbs.

RW-27A..... Complete 7.95



Sensitive Pocket AC-DC Multitester With Both Capacitance and Inductance Ranges

- 100 UA 3" METER
- 1% PRECISION RESISTORS
- INDUCTANCE RANGE
- CAPACITANCE RANGE
- 2000 OHMS PER VOLT SENSITIVITY ON BOTH DC AND AC
- SILVER CONTACT SINGLE SELECTOR SWITCH

12.95

AC VOLTS: 0-6, 0-12, 0-60, 0-300, 0-1200 VOLTS. DC VOLTS: 0-6, 0-12, 0-60, 0-300,
0-1200 VOLTS. DC CURRENT: 0-300 UA, 0-3 MA, 0-300 MA. RESISTANCE: 0-10K, 0-100K,
0-1 MEGOHM. DECIBELS: -20DB to +15DB, +17DB to +37DB. CAPACITANCE: 250 MMFD
to .1 MFD. INDUCTANCE: 0-1000 Henries.

An exceptional value in a convenient accurate, complete instrument at a price lower than that of kits not having comparable features. The 20 full-scale ranges are chosen by a single silver contact selector switch. A simply installed 1 1/2 V nightlight cell provides an internal source for resistance measurements. The instrument has a sensitivity of 2000 ohms per volt on both DC and AC and employs precision 1% tolerance resistors. The DB scales are calibrated for use across 600 ohm lines. The capacity range requires an external 60 volt AC source. The inductance scale requires an external 6 volt AC source.

Extremely versatile and compact instrument with a beautiful plastic front panel in a metal case to provide ruggedness and shielding. Size: 3 3/4" x 5 3/4" x 1 3/4". Complete with batteries and test leads. Shpg. wt., 3 lbs.

RW360A..... In lots of 3 12.45..... Singly, Ea. 12.95



ANOTHER OUTSTANDING LAFAYETTE VALUE

- Most advanced engineering to fit the Serviceman's needs.
- Priced to fit the Serviceman's Pocketbook.

TUBE TESTER!

26.95

A new streamlined tube tester with a realistic approach to the problem of quickly testing the ever increasing number of tube types. It incorporates new and advanced engineering features and all at a price of about half of even the most ordinary tube tester. Read these Specifications.

"FREE POINT" ELEMENT SELECTOR SWITCHING: Newly designed, it reduces possibility of obsolescence to a minimum because any pin may be used as a filament pin and voltage applied between it and any other pin, or even the "top cap". Tubes with tapped filaments or with filaments terminating in more than 1 pin are truly tested.

MULTIPURPOSE TUBES: Special isolating circuit allow each section of multi-purpose tubes to be tested individually as if it were in a separate envelope.

SHORTS AND LEAKAGES: Supersensitive method checks shorts and leakages up to 5 megohm between any and ALL elements; continuity between various sections individually indicated.

SIMPLICITY: Fast simple operation. The 4 position fast action snap switches are all numbered in exact accord with RMA standards. Thus when testing element terminating in pin No. 7 of a tube — you use button No. 7. You can't insert a tube in the wrong socket — there's one for each type of tube base.

TUBE TYPES: Tests all octal, loctal, 7 pin miniatures, 9 pin miniatures as well as the new novel and Sub-Minar types. Old type sockets used for testing obsolete types — that you rarely see anymore — have been eliminated.

SIZE: A practical size to carry with you as well as for use in the shop — only 8 1/2 x 6 3/4 x 2 1/4" deep. Shpg. Wt. 5 lbs.

MODEL TC-55 — complete with carrying case and instructions. **26.95**



NEW! SLOPING PANEL MULTITESTER

2,000 Ohm per Volt Sensitivity on both DC and AC

- SLOPING PANEL FOR EASY READING
- 4 RESISTANCE RANGES ON TWO SEPARATE SCALES
- SENSITIVE 3 1/4" 160 MICROAMP METER MOVEMENT
- 25 FULL SCALE RANGES INCLUDING 5 OUTPUT RANGES

14.95

This unusual Multitester is a complete instrument (not a kit) with high quality and sensitive 160 microamp meter. Features extreme versatility, accuracy and ruggedness. In an attractive bakelite front panel, with metal bottom for ruggedness and shielding. Single switch selects all ranges; 1% precision resistors used throughout. An outstanding instrument, for the professional, serviceman or laboratory. FULL SCALE RANGES: DC Volts: 0-10; 0-50; 0-250; 0-500; 0-1000. AC Volts: 0-10; 0-50; 0-250; 0-500; 0-1000. Output Volts: 0-10; 0-50; 0-250; 0-500; 0-1000. DC Current: 0-500 microamps; 0-2.5 MA; 0-25 MA; 0-250 MA; Resistance: 0-1K; 0-10K; 0-100K; 0-1 Meg; Decibels: +22 and +50 db (0 db = 0.755V-600 ohm). COMPLETE with test leads and BATTERIES. Convenient Pocket SIZE 3 3/4" x 5 3/4" x 2-2/5". Shpg. wt., 4 lbs.

RW-29Y.....NET 14.95.....In lots of 3, ea. 14.25



Great LAFAYETTE Buys on Phono Parts

3 SPEED TURNOVER HIGH OUTPUT PICKUP



ONLY 3.45
In Lots of 3
Singly Ea.
3.75

REG. VALUE 9.00

- 3 VOLT OUTPUT
- TURNOVER CARTRIDGE
- DUAL SAPPHIRE STYLI
- FREQUENCY RESPONSE TO 9000 CYCLES

Here is a real value in a 3 speed, pickup, complete with turnover cartridge and 2 sapphire styli to play all speeds. One stylus is 3 mil for standard (78) speed records, the other 1 mil for LP records. For all records up to 12 inch. Attractively styled and finely finished die cast arm. Easy single hole mount. Shpg. wt. 1 lb.
PK-89.....In lots of 3, Each **3.45**
Singly, Each **3.75**

HIGH FIDELITY PICKUP

WITH 8 OUTSTANDING FEATURES



\$5.25
Ea.
In Lots of 3
Singly
5.45

- 1 FREQUENCY RESPONSE 40-14,000 CPS
- 2 TURNOVER TYPE CARTRIDGE
- 3 DUAL SAPPHIRE STYLI
- 4 ADJUSTABLE NEEDLE PRESSURE
- 5 BASE ADJUSTABLE FOR HEIGHT
- 6 TRIP LEVER FOR AUTOMATIC STOP
- 7 EASY FINGER LIFT
- 8 FELT PADDED ARM REST

Reg. Value 15.00

We've never before seen a replacement pickup so packed with valuable features at even double the price. Not only does it have an unusually wide frequency response but it has refinements heretofore found only in expensive units. The base is adjustable so bottom of pickup may be set from 7/8" to 1 1/2" above mounting base. This makes mounting easy on panels below level of turntable. A trip lever is provided in case you want to install a switch to turn off the motor at the end of the cycle. (It may be disregarded if not used). A convenient metal knob on side adjusts the spring tension so that proper needle pressure may be applied even for old and worn records. The turnover cartridge has an output of one (1) volt and is equipped with a sapphire 1 mil stylus for LP records and a 3 mil sapphire stylus for 78 RPM records. The entire unit is beautifully styled, graceful in design, and finished in an attractive maroon enamel. Even such items as the arm rest and trip lever are finely finished in gleaming nickel. Overall length 10". Shpg. wt. 2 1/4 lbs.
PK-91.....In lots of 3, Each **5.25**
Singly, Each **5.45**

PK-92—SAPPHIRE LP REPLACEMENT NEEDLE**69¢**
PK-92—SAPPHIRE STD. (78) REPLACEMENT NEEDLE **69¢**

Regular **8.50**



A Fantastically Low Price!

HIGH FIDELITY TURNOVER CARTRIDGE

*40-14,000 Cycles

Never before has a turnover cartridge of this quality been offered at such a price. We didn't believe it possible till we tried it. Frequency response from 40 to 14,000 cycles ±2db. Has 2 sapphire styli to play all speeds and types of records. Needle pressure is only 5 grams on LP and 12-15 grams on 78 RPM. Output is .5 volts. Comes complete with turnover mechanism and knob. Fits Webster, Garrard, VM, Collaro and tone arms of leading manufacturers of record changers and players. This is one of the most outstanding values Lafayette has ever offered. You can't match it anywhere.

PK-79.....In lots of 3, Each **2.50**.....Singly, Each **2.75**

PK-84... SAPPHERE LP REPLACEMENT NEEDLE**69¢**

PK-85.SAPPHERE STD (78) REPLACEMENT NEEDLE ..**69¢**

Only **2.75**

HIGH FIDELITY CARTRIDGE

MADE BY RONETTE OF HOLLAND

- WITH THE LOWEST INTER-MODULATION DISTORTION EVER ATTAINED.
- USED IN COLLARO CHANGERS.
- OUTPUT .7 VOLTS

Lafayette brings you this famous high fidelity cartridge for use in Collaro, Webster, Garrard and VM changers. Turnover type equipped with 2 sapphire styli to play all speeds. Frequency response to 9,000 cycles. Complete with turnover mechanism and knob. Fits most tone arms of leading manufacturers of record changers and players.

PK62 (TO—284-OV) In lots of 3, each. **3.25**
Singly, each..... **3.45**

3.25
In lots of 3, ea.
single, each
3.45



QUANTITY LIMITED

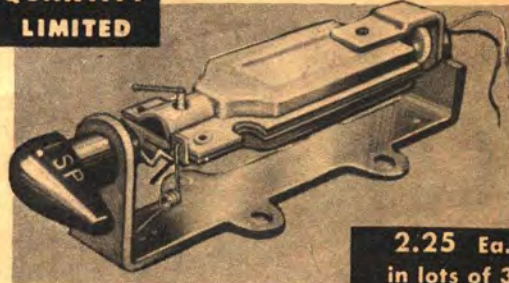

2.25 Ea.
in lots of 3
Singly, Ea.
2.50

3 VOLT TURNOVER CARTRIDGES

- High output = 3 Volts
- Dual Sapphire Styli
- Turnover Mechanism
- Excellent Frequency Response
- Easy Installation

Lafayette has gone all out to provide for the serviceman a replacement turnover phono cartridge at a price never before attained. Here is a crystal cartridge complete with two sapphire styli, turnover mechanism, mounting bracket and knob — with sufficient output to use in any record player — and yet of fine quality. All at a price that enables you to use it on any repair job. Length (less knob) 2 1/2". Ease of mounting assured by two sets of mounting holes, each set with 1/2" centers.

PK-80... Singly, Each **2.50**.....In lots of 3, Each **2.25**

PK-86... SAPPHERE LP REPLACEMENT NEEDLE**69¢**

PK-87.SAPPHERE STD (78) REPLACEMENT NEEDLE ..**69¢**

only **LAFAYETTE** can do it!

OUR DIRECT IMPORTATIONS

YOU SAVE IMPORTERS PROFIT!



New Professional TRANSCRIPTION TURNTABLE

THE FINEST TRANSCRIPTION TURNTABLE FOR BOTH THE PROFESSIONAL USER AND THE AUDIOPHILE



- 12" CAST ALUMINUM RIM DRIVEN TURNTABLE • HEAVY DUTY 4-POLE CONSTANT SPEED MOTOR • VARIABLE SPEED CONTROL, PERMITS CONTINUOUSLY VARIABLE ADJUSTMENT OF EACH SPEED WITHIN $\pm 7\%$ • SPEED SELECTOR SAFETY SWITCH • FREELY FLOATING MOTOR MOUNT • AUTOMATIC IDLER WHEEL DISENGAGEMENT WHEN OFF.

New 3-speed instrument to delight the connoisseur. The heavy 12" non-magnetic lathe-turned aluminum turntable is precision engineered to provide dynamic balance and "wow-free" operation and has an extra-heavy rim for smooth effective flywheel action. The turntable, mounted within a deep flanged well, is rim-driven and actuated by perfectly true pulleys and an oversized rubber idler wheel. The precision ground and polished nickel-chrome steel main spindle is ball-bearing mounted to assure noiseless, rumble-free rotation of the turntable. The extra-sized lubricant housing in which it is seated insures proper lubrication of the spindle at all times. A heavy rubber record cushion affords maximum record traction, eliminates slippage and makes for greater record protection.

A high torque, heavy-duty, constant speed 4-pole induction motor rotates the turntable at 33-1/3, 45 and 78 rpm. There is virtually no magnetic leakage and there is no hum pickup even with the sensitive variable reluctance cartridges. A dynamically balanced armature insures minimum wow and flutter content and accurate speed regulation. A variable speed control featuring an exclusive adjustable 3-point brake action permits instant adjustment of the individual speeds within $\pm 7\%$ and compensates for variations in source voltage which are encountered. With power off, the idler wheel is automatically disengaged to keep the idler perfectly round and true, preventing rumble. A speed selector safety switch protects idlers and other mechanism by making it obligatory to pass through an OFF position when switching from one speed to another. The motor is freely suspended and isolated by means of three unique shock mountings which eliminate vibration transferal. For 110-130V 60 cycle AC with each unit also equipped with a pulley for 50 cycles. Power consumption is 12 watts. Wow is less than .2%, flutter less than 0.05% and there is practically no rumble. Size: 13 1/2" deep, 14" wide, and requires clearance of 2 3/4" above motorboard (excluding pick-up arm) and 3 3/4" below motorboard. Supplied with removable 3-speed stroboscopic disc for both 50 and 60 cycles, removable 45 rpm adapter and tone arm adapter. Handsome hammerstone gray finish. Shpg. wt. 20 lbs.

Reg. Value
74.50
Net
49.50

COMBINATION DEAL

PK-100 TURNTABLE AND PK-90 TONE ARM **59.50**

The above with G.E. RPX-052A DIAMOND and SAPPHIRE Cartridge **72.50**

TURNTABLE TONEARM AND NEW FAIRCHILD MODEL 225 "MICRADJUST" DIAMOND LP CARTRIDGE **87.50**



"FLOATING ACTION"

VISCOUS-DAMPED TRANSCRIPTION TONE ARM

PROFESSIONAL QUALITY TRANSCRIPTION PICKUP ARM FOR THE MOST EXACTING HIGH FIDELITY INSTALLATIONS

- JEWEL BEARING SUPPORT • PERFECT RECORD TRACKING • AUTOMATIC FLUID CONTROL OF TONE ARM MOVEMENT • ACCEPTS RECORDS UP TO 16 INCH DIAMETER • SOLDERLESS INSTANT PLUG IN CARTRIDGE CHANGE • ACCOMMODATES VIRTUALLY ALL STANDARD AMERICAN CARTRIDGES • PREVENTS TONE ARM DAMAGE TO RECORDS

This new Viscous-Damped tone arm represents the ultimate in advance transcription arm design and engineering, utilizing the principle of "viscous-damping" or fluid control to regulate both the horizontal and vertical movement of the tone arm. Perfect compliance is achieved at all three speeds for both old and new records at lowest stylus pressure, consequently eliminating tone arm resonance. The balance provided by this suspension principle virtually eliminates groove jumping and skipping. The slide-in cartridge holder allows instantaneous mounting of all standard types, including the turnover G.E. cartridge, with correct stylus pressure automatically obtained. Spring clips maintain positive electrical contact without necessity of soldering. The amount of damping and pressure is controlled by a manual viscosity adjustment mounted on top of the arm. A finger rest positions the tone arm. Records are protected against damage even when the tone arm is accidentally dropped. The arm is 12 inches long with its height fully adjustable by means of a telescoping shaft. Self-leveling screw adjustments are built into the tone arm base. A pick-up rest whose height is adjustable, accompanies the tone arm.

This tone arm is a professional quality companion to the PK100, with matching finish. Shpg. wt. 2 1/2 lbs. PK-90 Net **19.50**

Reg. Value
39.95
Net
19.50

SPECIAL!

ARM WITH G.E. RPX-052A DIAMOND AND SAPPHIRE CARTRIDGE **34.50**

WITH FAIRCHILD MODEL 225 "MICRADJUST" DIAMOND LP CARTRIDGE **49.50**



LAFAYETTE EXCLUSIVE

12" HIGH FIDELITY COAXIAL SPEAKER

- FREQUENCY RANGE 30-15000 CPS • HANDLES 20 WATTS OF POWER • COMPLETE WITH LEVEL CONTROL • POWERFUL TSK-5 MAGNETS • SPECIAL SHEEP-SKIN-EDGED CONE

This Lafayette exclusive import is a highly efficient 12" coaxial speaker and represents an exceptional high fidelity value. The low frequency woofer has a 12" special chemically processed fibre composition cone with logarithmically placed pleats. The low resonant cone achieves a floating edge by means of a free edge of sheepskin which suppresses unwanted circular and radial nodal vibrations and insures clear beautiful tone quality. A 2 1/2" tweeter is coaxially mounted within its own metal case and protective grille with front mounted diffuser. The construction is such that there is no back radiation whatsoever. A crossover network to provide proper separation of high and low frequencies, and having a crossover point of 3000 cps, is also built-in. Highly efficient TSK-5 magnets permit a compact system, delivering full-bodied brilliant tone. A high frequency level control provides variation of up to 6 db cut. Power handling capacity is 20 watts continuous and 35 watts peak. Voice coil impedance 8 ohms, resonant frequency 40 cps. Connections are made to screw cap terminals. Rugged all-metal frame. If made in this country this speaker would sell for at least \$49.50. Shpg. wt. 11 lbs.

Reg. Value
44.50
Net
29.50

SK-58 Net **29.50**



YOU BE THE JUDGE!

Custom High Fidelity Phono System Of Superior Quality

If this system does not give you utmost satisfaction and represent a tremendous saving, you may return it for a cash refund! Need we say more?!!!



ONLY LAFAYETTE CAN MAKE THIS OUTSTANDING OFFER BACKED BY A MONEY-BACK GUARANTEE!

- FINEST 3-SPEED TRANSCRIPTION TURNTABLE WITH VARIABLE SPEED CONTROL • PROFESSIONAL QUALITY VISCOUS-DAMPED TRANSCRIPTION TONE ARM • LATEST FAIRCHILD CARTRIDGE MODEL 225 WITH DIAMOND LP STYLUS • COMPLETE, DELUXE PRINTED CIRCUIT AUDIO AMPLIFIER
- 12" HIGH FIDELITY COAXIAL SPEAKER

A phono-system with the finest professional quality TRANSCRIPTION TURNTABLE and VISCOUS-DAMPED PICKUP arm and equipped with the newest FAIRCHILD DIAMOND LP CARTRIDGE. The LAFAYETTE MODEL LA54 AMPLIFIER has many advanced technical features as does the SK58 SPEAKER which is capable of superb response. It is no wonder that we urge you to judge both the fine quality and outstanding value contained in this Lafayette offer. Once you hear its excellent audio fidelity and observe its dependable performance, you too will become enthused by this unusually popular combination of moderately priced, professional type hi-fi components. Com-

plete system with interconnecting plugs and cables and ready for instant installation.

For 110-120V, 60 cycles AC. Shpg. wt. 46 lbs.

HF-126 Net **169.50**

System with GE RPX-052A Diamond-Sapphire Cartridge.

Same system as above with the GE RPX-052A Triple-Play Cartridge with DIAMOND LP and SAPPHIRE standard styl.

HF-127 Net **154.50**

New
"FLOATING ACTION"

LAFAYETTE HIGH FIDELITY TRANSCRIPTION TURNTABLE AND TONE ARM COMBINATION



77.45

FINEST TRANSCRIPTION TURNTABLE MODEL PK-100 AND VISCOUS-DAMPED TONE ARM MODEL PK-90 ON BEAUTIFULLY FINISHED WOOD BASE

Professional 3-speed turntable with variable speed control and fluid-controlled tone arm plays all records up through 16" transcription discs. The heavy duty, high torque 4-pole shaded induction motor is shock-mounted and freely suspended to eliminate vibration. Meets professional standards for wow, flutter content and speed regulation. The heavy die-cast aluminum turntable is rim-driven, dynamically balanced and ball bearing mounted to provide rumble-free rotation. The tone arm accommodates all standard type cartridges with instant, solderless, plug-in cartridge change. The viscous damping achieves perfect compliance yet prevents groove jumping and skipping as well as record and stylus damage should the tone arm be accidentally dropped.

The substantial woodbase is a deluxe unit which is made of the finest selected solid hardwood outside pieces and has mitered corners secured with clamp nails. The mounting board is free-floating on individual springs in each corner which can be individually leveled. The base has a genuine hand-rubbed finish and comes in five cabinetmaker shades, red mahogany, brown mahogany, blonde, ash and ebony. Specify your choice when ordering. The top of the motorboard has an attractive copper finish. Its elegant styling and finish adds beauty to any high fidelity installation. Size: 16" x 20" x 5".

Complete unit ready to install, requiring easy mounting of turntable and tone arm on pre-cut mounting board. For operation from 110-130V 50/60 cycles AC. Shpg. wt. 36 lbs. HF-128 (less cartridge) Net **77.45**

Woodbase only . . . Shpg. wt. 13 lbs.

PK-95 . . . Red Mahogany

PK-96 . . . Brown Mahogany

PK-97 . . . Blonde

PK-98 . . . Ash (Illustrated above)

PK-99 . . . Ebony

19.50

BUILD YOUR OWN HI-FI KITS



**DeLuxe 9
TUBE FM
TUNER
KIT**

29.50

DeLuxe 9 TUBE FM TUNER KIT

- 9 TUBES PLUS SELENIUM RECTIFIER
- 20-20,000 CPS \pm 1/2 DB
- TEMPERATURE COMPENSATION THROUGHOUT
- ARMSTRONG CIRCUIT
- SELF-CONTAINED AC POWER SUPPLY

Quality parts plus an excellent circuit make this a top-notch unit. Uses a 3 gang variable, iron core tuned I.F.'s and discriminator transformers, heavy 16 gauge copper plated and lacquered chassis. Features include Armstrong circuit, hum level -70 db below average output, output volts average .5 volts RMS, sensitivity of 10 u/v -20 db, 200kc bandwidth and tuned RF stage. Controls are tuning, volume with On-Off switch, and FM-Phono switch. Covers 88-108mc. Self-contained 115 volt 60 cycle AC power supply. Tubes are 4-6AU6, 2-6AB4, 1 each 6CB6, 6AL5 and 6CA cathode follower output plus selenium rectifier. Every part is of finest quality—even the sockets are mica filled. Illustrated dial, rich gold finished escutcheon panel and matching brass-inlay knobs. Chassis dimensions 9 3/4" L x 5" H, x 5 7/8" W. Included is 28 page 8 1/2" x 11" book complete with pictorial, mechanical and schematic diagrams, plus step by step assembly instructions. Kit is complete with tubes and all parts. Shpg. weight 11 lbs.

V9K Kit **29.50**

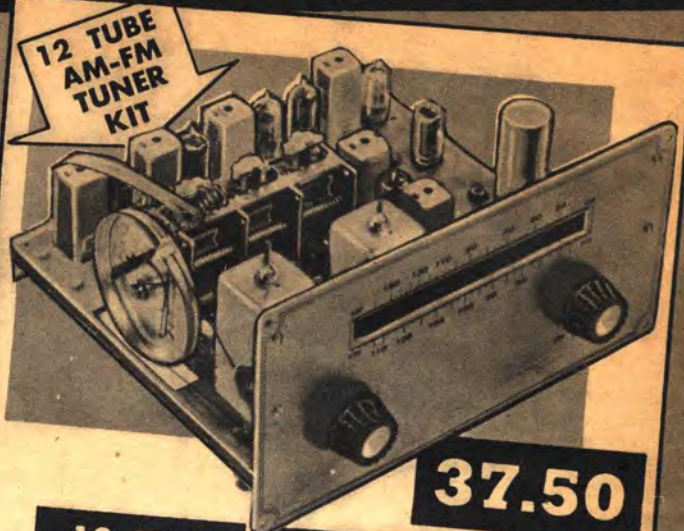

**12 TUBE
AM-FM
TUNER
KIT**

37.50

12 TUBE AM-FM TUNER KIT

- 12 TUBES PLUS CRYSTAL DIODE DETECTOR
- COMPACT — STABLE — SENSITIVE
- ARMSTRONG CIRCUIT — TEMPERATURE COMPENSATION
- FM RESPONSE 20-20,000 CPS \pm .5
- 48 PAGE INSTRUCTION BOOK

Build this fine 12 tube AM-FM tuner that covers both 88-108MC and 530-1650KC AM and FM bands with superb quality. Frequency response is -20-20,000 CPS \pm .5 db on FM, and 20-7500 CPS \pm 3 db on AM. Twelve tube circuit includes 4-6AU6, 2-6AB4, 2-6BA6, 1 each 6CB6, 6AL5, 6BE6, and 6CA cathode follower output plus 1N34-60 crystal diode detector. Has 6 section variable oscillator coils, iron core tuned I.F., discriminator antenna, RF and AM & FM. Hum level is -70 db below average output. Drift is 5-10 u/v, 20-30 db on FM, 5 microvolts on AM. Controls are tuning and 3 position switch for AM, FM, On-Off. Copper plated gold finished escutcheon panel and brass inlay knobs. 48 page instruction manual is replete with easy to follow pictorial, mechanical and schematic diagrams with step by step instructions for assembly and operation. External power supply required is 190 volts DC-55 ma and 6.3 volts AC 4 amp. Model A620 power supply Shpg. weight 12 lbs.

IMPERIAL V AM-FM KIT **NET 37.50**

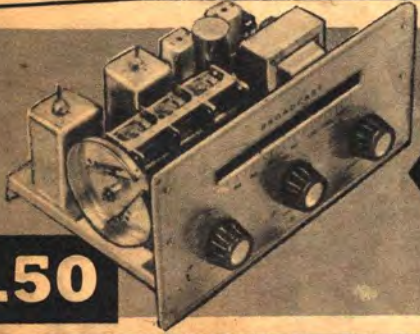

**AM
TUNER
KIT**

24.50

- 5 TUBES PLUS SELENIUM RECTIFIER
- 5 MICROVOLT SENSITIVITY

Covers the AM broadcast band from 530-1650 KC. Self contained AC power supply 115V AC 60 cycle. Outstanding quality achieved by excellent circuit using rugged 3 gang variable condenser, iron core tuned IF transformers, antenna, RF and oscillator coils. Has tuned RF stage for reduction of image interference. Tubes are 2-6BA6, 1 each 6BE6, 6AL5, and 6CA cathode follower output, plus selenium rectifier. Controls are Tuning, Volume with On-Off switch, and AM-Phono switch. Has illuminated dial, gold finished escutcheon panel, brass-inlay knobs. Copper plated lacquered chassis 9 3/4" L x 5" H x 5 7/8" Wide. Temperature compensation throughout for minimum drift. 28 page instruction manual with schematics, pictorial and step by step instructions. Complete with tubes. Shpg. weight 10 lbs.

V5-K Kit **24.50**

20 WATT WILLIAMSON TYPE AMPLIFIER KIT

FREQUENCY RANGE 10 to 100,000 CPS \pm .5 DB • USES TOP QUALITY CHICAGO TRANSFORMERS

Here for the first time is a 20 watt hi-fi amplifier kit that fits your pocketbook. Not only has it the phenomenal frequency response shown above, but harmonic distortion is only 1/2% from 20-20,000 cycles and hum level is -78 db below full output. Has continuously variable volume control, 4-8-16 ohm output impedances, self contained 105-125V AC power supply, AC on-off power switch and AC power outlet. Pre-amp voltage supply, 117V AC—6.3V 1 Amp, 280V at 7 ma, 200 volts at 10 ma. Tubes are 2-6SN7GT, 2-5881 push pull output, plus 5V4C rectifier. Mica filled sockets. Gleaming chrome plated chassis is 15" L x 7" H x 9" W, 24 page 8 1/2" x 11" book with pictorial and schematic diagrams with step by step instruction. Kit is complete with all parts and tubes. Shpg. wt. 32 lbs.



39.55

A-890—20 Watt Kit **39.55**

UNIVERSAL POWER SUPPLY

Completely wired. Choke filter system, electrostatically shielded, hum free. Completely isolated. Delivers 190 volts DC at 55 ma and 6.3 V at 4 amp. Size: 3 1/2" W x 4 5/8" H x 8" D. Shpg. Wt. 8 1/2 lbs.

A-620 Power Supply... **12.00**



12.00

Build Your Own Kits

ENJOY THE FINEST AND SAVE!

10 WATT PUSH PULL HI-FI AMPLIFIER KIT

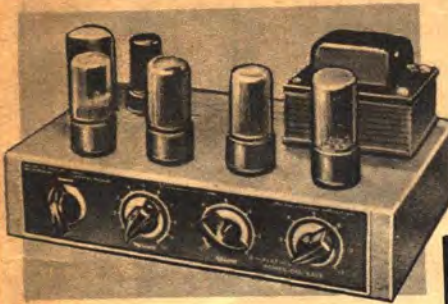

- BUILT-IN PREAMPLIFIER FOR GE RELUCTANCE CARTRIDGE
- SELECTOR SWITCHES PERMIT CHOICE OF THREE INPUTS
- SEPARATE BASS AND TREBLE CONTROLS
- 4, 8 AND 16 OHM OUTPUTS
- EASY-TO-FOLLOW INSTRUCTIONS

21.50

This new, economy hi-fi amplifier has many deluxe features for exceptional performance. The three inputs are radio/crystal phono pickup, magnetic phono pickup and microphone. A selector switches the input from radio/crystal to microphone or magnetic pickup, depending upon the position of a rear apron slide switch. **OUTPUT** — Rated 10 watts, peak 18. **FREQUENCY RESPONSE** — ± 1 db 30-15,000 cps. **DISTORTION** — 1.5% harmonic, 4% intermodulation at 8 watts. **4 CONTROLS** — Input Selector; Volume; Treble; Power-On-Off-Bass. **TREBLE CONTROL** — Flat response up to 15 db boost. **BASS CONTROL** — Flat response up to 18 db attenuation. **OUTPUT IMPEDANCES** — 4, 8 and 16 ohms. **TUBES** — 6C5CT, 6SL7GT, 2 — 6V6GT and 5Y3GT rectifier. **AUXILIARY AC OUTLET** — Distinctive Hammett finish. **SIZE** — $10\frac{1}{2}'' \times 6\frac{1}{4}'' \times 5\frac{1}{4}''$. **WEIGHT** — $8\frac{1}{2}$ lbs. For 110-120 Volts. Complete kit with coded wire, highest grade solder and detailed instruction manual. Net **21.50** **KT-91**

PUSH-PULL — 6 WATT HI-FI AMPLIFIER KIT

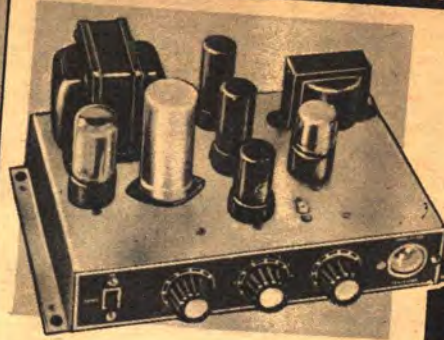

- LOW COST, REALISTIC HI-FI KIT
- CATHODE-RAY OUTPUT INDICATOR
- HUM LEVEL—78 DB BELOW FULL OUTPUT
- 4, 8 and 16 OHM OUTPUT IMPEDANCES
- PHASE INVERTER PUSH-PULL OUTPUT
- 24 PAGE ILLUSTRATED INSTRUCTION BOOK

15.45

A high-quality down-to-earth priced hi-fi audio amplifier kit with frequency response with separate AC on-off power switch. Self-contained AC power supply, 117 volts, 50-60 cycles bass control boost 12 DB and treble control boost 12 DB. Maximum 6 watt output requires but .5V input. The tube complement consists of 12J5—1st amplifier, 12SL7—cathode-ray output indicator. Mica filled sockets. The chrome plated chassis is a compact size $11''$ long, $6\frac{1}{2}''$ wide and $5\frac{1}{2}''$ high and is adaptable to book shelf mounting. Supplied with escutcheon template and matching silver-inlay knobs. Complete with instruction book containing step-by-step pictorial and schematic diagrams. Shpg. wt., 13 lbs. **A-870** Net **15.45**

5-WATT PUSH-PULL AC-DC HI-FI AMPLIFIER KIT



- SEPARATE VOLUME, BASS AND TREBLE CONTROLS
- PUSH-PULL AUDIO OUTPUT STAGE
- INVERSE FEEDBACK CIRCUIT
- AC OR DC OPERATION

10.95

Here in kit form is an AC-DC hi-fi amplifier that presents unusual features despite its amazingly low price. The separate bass and treble controls permit adjustment of both low and high frequency response and balance. Works equally well with both crystal or ceramic cartridges. Has a 4-tube line up—a 12AX7 amplifier and phase inverter, a 35W4 rectifier and a pair of 35C5's in push-pull, having a power-packed low distortion output. The circuit utilizes an inverse feedback loop to reduce the level of hum and distortion. Kit is complete containing all essential parts, tubes and detailed instruction manual showing pictorial and schematic diagrams. Shpg. wt., 4 lbs. **KT-92** Net **10.95**

PREAMPLIFIER KIT WITH BUILT-IN SIX POSITION EQUALIZER FOR G.E. AND PICKERING CARTRIDGES

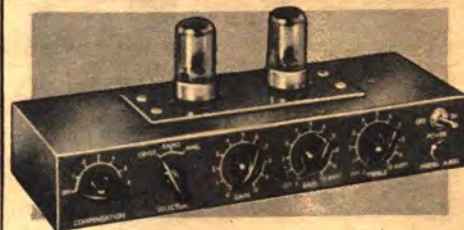

- 3 POSITION INPUT SELECTOR SWITCH
- OVERALL GAIN CONTROL
- SEPARATE BASS AND TREBLE CONTROLS
- FLOATING TUBES TO PREVENT MICROPHONISM

15.95

This preamplifier designed for use with Williamson-type and other high quality audio amplifier systems. There are 3 input connectors, radio, crystal and magnetic, with corresponding 3 input selector switch. The separate bass and treble controls approximate 15 DB. The 6 position equalizer assures proper playback of all types of recordings. The two 7F7 tubes are free-floating to prevent tube microphonism. Separate on-off switch and pilot light. Power required by this unit is 6.3V — .6A AC or DC and 150V DC at 7 milliamperes. This power may be obtained from the A890 or any similar amplifier. Power line cord, power switch, pilot light and rear mounted power outlet for main amplifier provided. Supplied with 36" power supply cable for easy connection to main amplifier. The unit is $12'' \times 4'' \times 2''$ and comes in a rich gold finish. Complete with tubes and all parts and 24-page instruction manual containing pictorial and schematic diagrams for step-by-step assembly and wiring. Shpg. wt., 6 lbs. **A-800** Net **15.95**

TECHMASTER HI-FI FM TUNER KIT



29.50

A superior quality basic hi-fi FM tuner kit designed for optimum performance and fidelity at a minimum cost. Features advanced drift-free circuitry having excellent selectivity and clean, faithful audio reproduction. Self-contained power supply. Micro-vernier tuning covers 87-109 MC range. Full 200KC IF bandwidth. Has a grounded grid RF stage. The AFC has a manual front-control cutoff to pick up weak signal stations adjacent to strong signal stations. Contains a no-drift ratio detector and standard de-emphasis network. Cathode follower output permits long cable to amplifier without loss of highs. **SENSITIVITY**: 4 UV for 20 DB quieting. **OUTPUTS**: Cathode follower .8V RMS; high impedance 3.2V RMS. **TUBE COMPONENT**: 2-12A7, 6BA6, 6AU6, 6AL5, 6C4 plus selenium rectifier. **SIZE**: $4\frac{1}{2}'' \times 8'' \times 6\frac{1}{4}''$. **INPUT IMPEDANCE**: 300 ohms. Complete with punched chassis, all tubes and hardware (less wire and solder) with detailed easy-to-follow instructions. Shpg. wt., $6\frac{1}{2}$ lbs. **TECHMASTER FM-18** Net **29.50**

CM-18 Cabinet for Tuner Net **7.50**

TECHMASTER DELUXE SELF-POWERED PREAMP-EQUALIZER KIT



24.50

Anyone can build this fine self powered preamp-equalizer, and have a really professional instrument that will provide new beauty and versatility to your music reproducing system. Has 4 input channels, one low level high gain and 3 high impedance. Separate bass and treble controls give 15 db boost or attenuation at 20 cycles and 20 KC respectively. Perfect matching of recording curves assured by 5 position equalization control for 78 RPM, Old 78's R1AA, FRR and AES, 60 cycles — isolated transformer. Cathode follower rectifier. AC power supply for 115V control. It's simple to build. Sockets, terminals and connectors riveted on chassis. Size $9\frac{7}{8}'' \times 3\frac{7}{8}'' \times 4\frac{1}{2}''$. Shpg. wt. 5 lbs. **TECHMASTER TM-16SP** Net **24.50**

Net **24.50**

STAY AHEAD IN TRANSISTORS These Books Show You How

ELECTRONS AND HOLES IN SEMICONDUCTORS

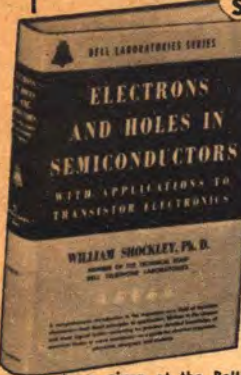

by William Shockley, PH.D.

Here, clearly and accurately presented, are theoretical and practical texts from one of the world's greatest industrial laboratories. This book has been prepared to provide a practical theoretical and working knowledge of the properties and uses of transistor devices for electrical engineers, physicists, designers, and students, whether or not they possess the mathematical knowledge formerly essential to an understanding of quantum theory or wave mechanics. The organization and content are based upon a series of lectures given at the Bell Telephone Laboratories. The developmental approach is particularly well adapted to furthering an understanding of the method by which the behavior of holes and electrons can now be inferred directly from the new post-transistor experiments, with a sufficient degree of definiteness for most purposes of transistor electronics. Charts, graphs and illustrations throughout.

551 pages 9.75

FUNDAMENTALS OF TRANSISTORS



by Leonard Krugman

Learn all about the transistor! It's the thing in electronics today! With more and more uses for the transistor being developed all the time, every service technician, student, engineer, and experimenter... should be familiar with the transistor—should know their characteristics and operation! Leonard Krugman, who wrote this authoritative book, is one of the pioneers in transistor development and application. His presentation covers every phase—everything you need to know about this electronic miracle! No complicated mathematics—it is clearly written so everyone can understand! Provides workable information on the transistor without the burden of theory and mathematical concepts. Careful study of this book will provide a basic foundation upon which to build further study and experimental work.

Rider #160—134 pages with illustrations..... 2.70

28 USES FOR JUNCTION SYLVANIA ELECTRIC TRANSISTORS



Here is a new booklet of practical applications for transistors of interest to servicemen, experimenters, students, hobbyists and industrialists. This booklet lists twenty-eight popular uses for transistors. Prepared from laboratory data accumulated from tests of many devices. While the booklet is addressed primarily to experimenters and electronic hobbyists, we believe that engineers and technicians will find material of interest on its pages. Theory has been held to a minimum. A list of theoretical references appears at the end of the first chapter. The booklet is profusely illustrated aside from the numerous tables and charts throughout.

41 Pages, Illustrated, 6" x 9" 25c

TRANSISTORS

by Coblenz & Owens



This Book treats theory, Practical applications and manufacture of Transistors in a very useful way. It contains a short history of Transistors, how they work, how they are made, and how they are used—Step-by-step from basic concept to advanced topics. Discusses both Silicon and Germanium transistors, and the latest circuits such as switching circuits, Cascading circuits, etc.

313 Pages, Illustrated, 6" x 9" 6.00



TRANSISTORS—THEORY & PRACTICE

by Rufus P. Turner

TRANSISTORS FROM THE VIEWPOINT OF THE PRACTICAL MAN

Information packed, this easy-to-read book explains semiconductor theory, transistor characteristics, equivalent circuits, transistor amplifiers, transistor oscillators, quality in transistor circuit design, triggers, switches, tests and measurements. Lists characteristics of commercial transistors.

Has numerous circuits for the builder or experimenter and data on practical transistor circuits. Contains recommended reading list at end of each chapter. Also lists characteristics of commercial transistors. Attractively bound in soft cover. Profusely illustrated.

Gernsback #51—144 pages—5 1/2" x 8 1/2" 2.00



TRANSISTORS

by Louis E. Garner, Jr.

"Transistors and Their Applications in Television-Radio Electronics," by Louis E. Garner, Jr. is the first practical book about transistors for servicemen, engineers, amateurs and experimenters. Explains in easy-to-understand language the theory and practical applications of transistors. Clarifies transistor circuitry, installation, testing techniques theory and servicing. Also covers development; physical and electrical properties; transistor amplifier circuits, oscillator circuits, special circuits and many other interesting subjects.

CTB-7—100 pages, illustrated 1/2" x 8 1/2" 1.50

TRANSISTOR AUDIO AMPLIFIERS

by Richard F. Shea



Outlines basic fundamentals of transistor application in the Audio Amplifier field. Shows how these principles can be applied in designs, and how to achieve the ultimate performance from these units. The treatment is general and can be applied to a great majority of specifications available from transistor manufacturers. A large amount of practical material is included, such as information on the design of pre-amplifiers and power amplifiers. Also provides necessary tools for designs of audio amplifiers to meet the demand of frequency response, signal to noise ratio etc. Contains various charts and tables.

219 Pages . . . Illustrated 6" x 9 1/4" 6.50

PRINCIPLES OF TRANSISTOR CIRCUITS

by Richard F. Shea



Mr. Shea, along with numerous co-authors has gathered a large portion of existing material on transistor circuits. The treatment is general, built around generalized, equivalent circuits that can be used to suitably represent a great majority of transistors. Each section presents and analyzes equivalent circuits, the mathematical relationships, and develops applicable circuits. Current network theory is used and modified to fit transistor applications. The book treats and analyzes both P-N-P and N-P-N units.

535 Pages . . . Illustrated 6" x 9 1/4" 12.75



TRANSISTOR ELECTRONICS

by Lo, Endres, Zawels, Waldhauer & Cheng — of RCA LABORATORIES

Here is a fully integrated approach to both the theory and practice of transistors and transistor circuits by five authorities in the field of electronics. Presented here for the first time are some of the results of their original research. The reader is taken from a basic working understanding of transistor operation and circuit analyses to practical circuit design technique. It discusses transistor operation at high frequencies — practical design procedure — and a full explanation of oscillators, modulators, detectors, and computer-type switching circuits. Over 365 illustrations, charts and tables.

508 Pages . . . Illustrated 6" x 8 1/2" 11.00

TRANSISTOR HANDBOOK

by W. D. Bevitt



The first handbook survey of the entire field of transistor circuits and applications. A thorough presentation of the practical aspects of transistors — what the transistor is doing toward making electronic circuits simpler, more efficient, more compact and in making possible new circuits. Covers fundamental physical concepts, characteristics, measurements, behavior, and circuit properties of transistors. Contains the most comprehensive subject index of its kind — 380 illustrations and a chart listing commercially available transistors and their characteristics.

426 Pages . . . Illustrated . . . 5 1/2" x 8 3/8" 9.00

LAFAYETTE RADIO

100 SIXTH AVE., NEW YORK 13, N.Y.

Return Postage Guaranteed

BULK RATE

U. S. POSTAGE

PAID

New York, N. Y.

Permit No. 8486

C R PARKER
1511 11TH ST
MANHATTAN BEACH CALIF

Lafayette Radio

NEW YORK 13, N. Y., 100 Sixth Ave., REctor 2-8600

NEWARK 2, N. J., 24 Central Ave., MARKET 2-1661

BRONX 58, N. Y., 542 E. Fordham Rd., FOrdham 7-8813

PLAINFIELD, N. J., 139 W. 2nd St., Plainfield 6-4718

BOSTON 10, MASS., 110 Federal St., HUBbard 2-7850

HOW TO ORDER

Use our convenient order blank (additional blanks sent on request). Please write in ink, legibly, and not more than ONE item to a line. Make sure you write the exact stock number and that the price is the one quoted for the item you want. Specify how we shall make shipment by checking the preferred square "Parcel Post", "Express" etc. We shall follow your instructions, but will change them wherever we are sure that such a change is to your better interest. Please keep all correspondence or remarks relative to your order on a separate sheet of paper. Make sure you include sufficient postage; all overpayments promptly refunded (if overpayment is under 10c, we will credit your account).

NOTE: In many instances, especially in the tabulated lists of merchandise, it is impossible to show shipping weights. In practically all cases, it is a simple matter to estimate the weight of each article. Please be sure to include sufficient postage. We will credit you with any overpayments.

DOMESTIC ORDERS

We buy for cash and sell for cash; this explains our low price policy. We do not carry credit accounts, and we pass on to our customers all savings effected by the elimination of costly bookkeeping. We will ship C.O.D. if desired, providing a deposit of at least 25% accompanies your order. C.O.D. parcels may be shipped ONLY to places in the 48 states of the U. S. and to U. S. territories. Remittance in full saves you extra collection costs.

ORDERS OUTSIDE OF THE CONTINENTAL UNITED STATES

All orders outside of the continental United States are handled at our main office in New York, and should be marked to the attention of our Export Department. All prices on such orders are net, F.O.B. our New York City warehouse, subject to change without notice. The merchandise is payable by either confirmed, irrevocable letter of credit, or by a remittance in United States dollars on a New York bank, and should include enough to cover shipping, insurance, and consular expenses. All orders should have a minimum merchandise value of \$40.00. Goods are packed in cardboard cartons; for wooden export packing there is a slight additional charge. Please send all correspondence by air for faster service.

DO NOT RETURN ANY MERCHANDISE BEFORE OBTAINING OUR AUTHORIZATION.

FINAL PRICES

Prices shown in this catalog are net, and except where marked POSTPAID, do not include postage. All discounts have been deducted, including 2% discounts for cash. Prices are subject to change without notice; we give customers the benefit of all reductions taking place after the catalog is published. Orders are filled at prices in effect at time of shipment.

POSTPAID ITEMS

Items marked "Shipped Postpaid" do not require postage. Please note that Postpaid items refer only to shipments made within the 48 states of the U. S. (S. possessions not included.)

SENDING MONEY

The safest and best way to send money is by: American Express; Post Office or Telegraph Money Order; bank drafts; firm checks; stamps. Do not send cash. If absolutely necessary to remit cash, send by registered mail only. Do not hesitate to include sufficient postage; over-payments are promptly refunded.

RETURNING MERCHANDISE

This order blank will be returned to you upon shipment of your order. If you find it necessary to return any merchandise for adjustment, please write returning the order blank and any attached papers, stating the following: reason for return, when and where purchased, number and date of sales slip if purchased at salesroom. If your shipment is received damaged, obtain a report from the postmaster or express agent and mail it to us. Use a separate sheet of paper for all adjustment matter; do not add remarks to a new order for parts. Do not include money in the package you return. When returning merchandise, pack carefully, insure, and write your name and address on all packages and letters before returning to us.

NOTE: Equipment built or ordered especially to meet customers requirements not subject to exchange, credit or refund. All orders for special merchandise must be accompanied by a deposit.

PARCEL POST RATES FOR ALL ZONES SUBJECT TO POST OFFICE RATE CHANGES

Parcels up to 8 ounces may be shipped anywhere in the United States for 8c. Parcel Post shipments over 8 ounces, mailed at a first class post office, addressed for delivery at another first class post office, shall be limited in size and weight as follows:— 72 inches in length and girth combined; 40 lbs to 1st and

2nd zones (150 miles) and 20 lbs. in the 3rd to 8th zones. Example: a package 35 in. long, 10 in. wide and 5 in. high measures 65 in. in length and girth combined (length 35 in. plus twice 10 in. width, plus twice 5 in. height, equals 65 in.)

WEIGHT IN LBS.	LOCAL	ZONES							
		1-2 UP TO 150 MILES	3 150 TO 300 MILES	4 300 TO 600 MILES	5 600 TO 1,000 MILES	6 1,000 TO 1,400 MILES	7 1,400 TO 1,800 MILES	8 OVER 1,800 MILES	
1.....	\$0.18	\$0.23	\$0.23	\$0.24	\$0.26	\$0.28	\$0.30	\$0.32	
2.....	.20	.27	.29	.31	.36	.40	.46	.51	
3.....	.21	.3	.34	.38	.45	.52	.61	.69	
4.....	.23	.34	.39	.45	.54	.64	.76	.87	
5.....	.24	.39	.44	.52	.63	.76	.91	1.05	
6.....	.26	.43	.49	.59	.73	.88	1.06	1.23	
7.....	.27	.47	.54	.66	.82	1.00	1.22	1.41	
8.....	.29	.51	.60	.73	.91	1.12	1.37	1.59	
9.....	.30	.55	.65	.80	1.00	1.24	1.52	1.77	
10.....	.32	.59	.70	.87	1.10	1.36	1.67	1.95	
11.....	.33	.63	.75	.93	1.19	1.48	1.82	2.13	
12.....	.34	.67	.80	1.00	1.28	1.60	1.98	2.31	
13.....	.36	.71	.85	1.07	1.37	1.72	2.13	2.49	
14.....	.37	.75	.90	1.14	1.47	1.84	2.28	2.67	
15.....	.39	.79	.96	1.21	1.56	1.96	2.43	2.85	
16.....	.40	.83	1.01	1.28	1.65	2.08	2.58	3.03	
17.....	.42	.87	1.06	1.35	1.74	2.20	2.74	3.21	
18.....	.43	.91	1.11	1.42	1.84	2.32	2.89	3.39	
19.....	.45	.95	1.16	1.49	1.93	2.44	3.04	3.57	
20.....	.46	.99	1.21	1.56	2.02	2.56	3.19	3.75	
FOR EACH ADDED LB.									
ADD	2c	4c	5c	7c	9c	12c	15c	18c	

APPROXIMATE EXPRESS CHARGES (SUBJECT TO RATE CHANGES)

Express charges are also determined by the weight of the shipment and the distance of consignee from the shipper. The following chart indicates approximate charges. Add 3% Federal Excise Tax.

WEIGHT	100 MILES	150 MILES	300 MILES	500 MILES	750 MILES	1000 MILES	2000 MILES	2500 MILES	3000 MILES
20 Lbs.	2.00	2.17	2.35	2.75	2.92	3.35	3.93	4.37	4.87
30 "	2.26	2.52	2.78	3.42	3.64	4.29	5.16	5.81	6.56
40 "	2.51	2.86	3.21	4.06	4.35	5.22	6.39	7.26	8.25
50 "	2.77	3.21	3.64	4.71	5.07	6.16	7.61	8.70	9.94
60 "	3.03	3.55	4.08	5.35	5.79	7.10	8.84	10.14	11.63
70 "	3.29	3.90	4.51	6.00	6.51	8.03	10.06	11.59	13.32
80 "	3.55	4.24	4.94	6.64	7.22	8.97	11.29	13.03	15.02
90 "	3.80	4.59	5.37	7.29	7.94	9.90	12.52	14.48	16.71
100 "	4.06	4.93	5.80	7.93	8.66	10.84	13.74	15.92	18.40

CATHODE RAY and TRANSMITTER Type Tubes Take a Higher Rate.

INSURANCE

Parcel Post Insurance Rates
 5c for parcels valued up to \$5.00
 10c " " " from \$5.01 to \$10.00
 15c " " " " \$10.01 to \$25.00
 20c " " " " \$25.01 to \$50.00
 30c " " " " \$50.01 to \$100.00
 35c " " " " \$100.01 to \$200.00

Express Insurance Rates

For shipments under \$50.00, no extra insurance charge.
 For shipments valued from \$50.00 to \$150.00, 18 cents
 For each additional \$100.00 value or part thereof beyond \$150.00, add 18 cents.

EXPRESS & FREIGHT SHIPMENTS

Express and freight shipments are sent transportation charges collect. If your station has no agent, please send sufficient money to cover transportation. Charges are the same either way. All over-payments are promptly refunded.

C.O.D. SHIPMENTS

Transportation charges on C.O.D. parcels are slightly higher than those sent prepaid. C.O.D. charges in addition to the regular postage costs outlined above are as follows (including insurance):

When the value of the parcel is from
 \$0.1 to \$5.00 the extra charge is 30c
 5.01 to 10.00 " " " 40c
 10.01 to 25.00 " " " 60c
 25.01 to 50.00 " " " 70c
 50.01 to 100.00 " " " 80c
 100.01 to 150.00 " " " 90c
 150.01 to 200.00 " " " \$1.00

The Post Office also charges an extra small money order fee on each C.O.D. parcel. Save these fees by remitting in full.

Orders from within the five boroughs of New York City are subject to N. Y. City sales tax unless accompanied by evidence of exemption.